

N-Channel Enhancement Mode Power MOSFET

Description

The SK2306 uses advanced trench technology to provide excellent $R_{DS(ON)}$ and low gate charge. This device is suitable for use as a load switch or in PWM applications.

General Features

- $V_{DS} = 30V, I_D = 3.6A$
 $R_{DS(ON)} < 73m\Omega @ V_{GS}=4.5V$
 $< 58m\Omega @ V_{GS}=10V$
- High power and current handling capability
- Lead free product is acquired
- Surface mount package

Application

- Battery protection
- Load switch
- Power management

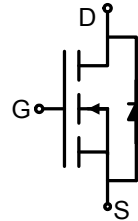

Schematic diagram



SOT-23 top view

Marking and pin assignment

Absolute Maximum Ratings ($T_A=25^\circ C$ unless otherwise noted)

Parameter	Symbol	Limit	Unit
Drain-Source Voltage	V_{DS}	30	V
Gate-Source Voltage	V_{GS}	± 20	V
Drain Current-Continuous	I_D	3.6	A
Drain Current-Pulsed (Note 1)	I_{DM}	15	A
Maximum Power Dissipation	P_D	1.7	W
Operating Junction and Storage Temperature Range	T_J, T_{STG}	-55 To 150	$^\circ C$

Thermal Characteristic

Thermal Resistance, Junction-to-Ambient (Note 2)	$R_{\theta JA}$	73.5	$^\circ C/W$
--	-----------------	------	--------------

Electrical Characteristics ($T_A=25^\circ C$ unless otherwise noted)

Parameter	Symbol	Condition	Min	Typ	Max	Unit
Off Characteristics						
Drain-Source Breakdown Voltage	BV_{DSS}	$V_{GS}=0V, I_D=250\mu A$	30	33	-	V
Zero Gate Voltage Drain Current	I_{DSS}	$V_{DS}=30V, V_{GS}=0V$	-	-	1	μA



Gate-Body Leakage Current	I_{GSS}	$V_{GS}=\pm 20V, V_{DS}=0V$	-	-	± 100	nA
On Characteristics (Note 3)						
Gate Threshold Voltage	$V_{GS(th)}$	$V_{DS}=V_{GS}, I_D=250\mu A$	1.2	1.5	2.2	V
Drain-Source On-State Resistance	$R_{DS(ON)}$	$V_{GS}=4.5V, I_D=3.1A$	-	58	73	m Ω
		$V_{GS}=10V, I_D=3.6A$	-	40	58	m Ω
Forward Transconductance	g_{FS}	$V_{DS}=5V, I_D=3.6A$	-	11	-	S
Dynamic Characteristics (Note4)						
Input Capacitance	C_{iss}	$V_{DS}=15V, V_{GS}=0V,$ $F=1.0MHz$	-	230	-	PF
Output Capacitance	C_{oss}		-	40	-	PF
Reverse Transfer Capacitance	C_{rss}		-	17	-	PF
Switching Characteristics (Note 4)						
Turn-on Delay Time	$t_{d(on)}$	$V_{DD}=10V, I_D=3.6A$ $V_{GS}=4.5V, R_{GEN}=6\Omega$	-	10	-	nS
Turn-on Rise Time	t_r		-	50	-	nS
Turn-Off Delay Time	$t_{d(off)}$		-	10	-	nS
Turn-Off Fall Time	t_f		-	20	-	nS
Total Gate Charge	Q_g	$V_{DS}=15V, I_D=3.6A,$ $V_{GS}=10V$	-	4.0	-	nC
Gate-Source Charge	Q_{gs}		-	0.75	-	nC
Gate-Drain Charge	Q_{gd}		-	0.65	-	nC
Drain-Source Diode Characteristics						
Diode Forward Voltage (Note 3)	V_{SD}	$V_{GS}=0V, I_S=2.7A$	-	0.8	1.2	V
Diode Forward Current (Note 2)	I_S		-	-	1.6	A

Notes:

1. Repetitive Rating: Pulse width limited by maximum junction temperature.
2. Surface Mounted on FR4 Board, $t \leq 10$ sec.
3. Pulse Test: Pulse Width $\leq 300\mu s$, Duty Cycle $\leq 2\%$.
4. Guaranteed by design, not subject to production

SHIKE MAKE CONSCIOUS PRODUCT

CONSCIOUS PRODUCTS BEGIN WITH CONSCIOUS PEOPLE



Typical Electrical and Thermal Characteristics

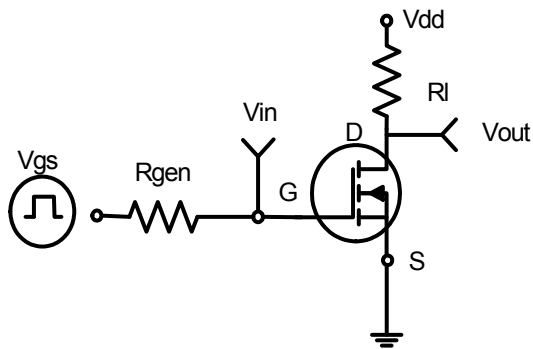

Figure 1: Switching Test Circuit

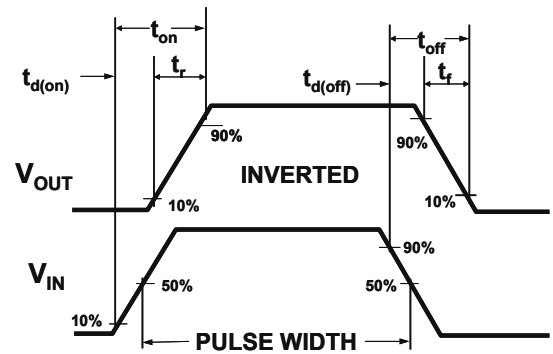
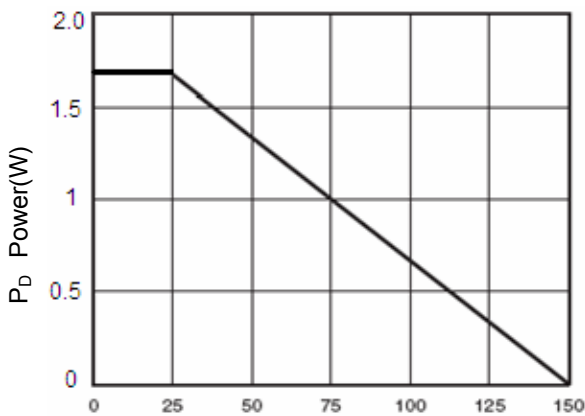
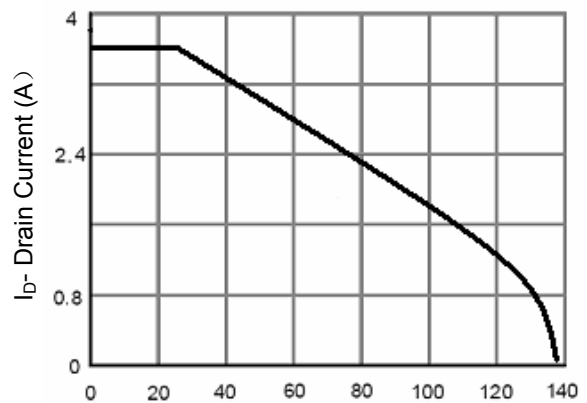

Figure 2: Switching Waveforms



T_J-Junction Temperature (°C)
Figure 3 Power Dissipation



T_J-Junction Temperature (°C)
Figure 4 Drain Current

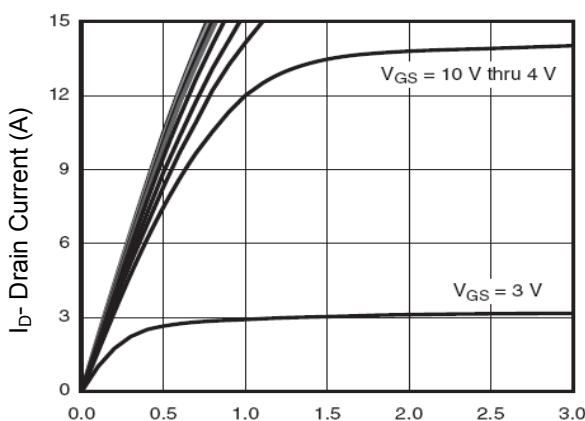

V_{DS} Drain-Source Voltage (V)
Figure 5 Output Characteristics

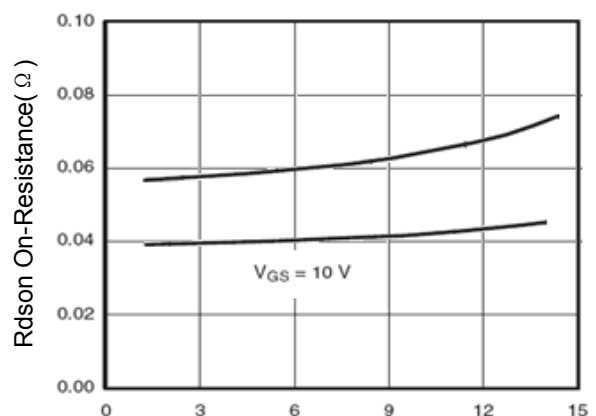

I_D-Drain Current (A)
Figure 6 Drain-Source On-Resistance

SHIKE MAKE CONSCIOUS PRODUCT
CONSCIOUS PRODUCTS BEGIN WITH CONSCIOUS PEOPLE



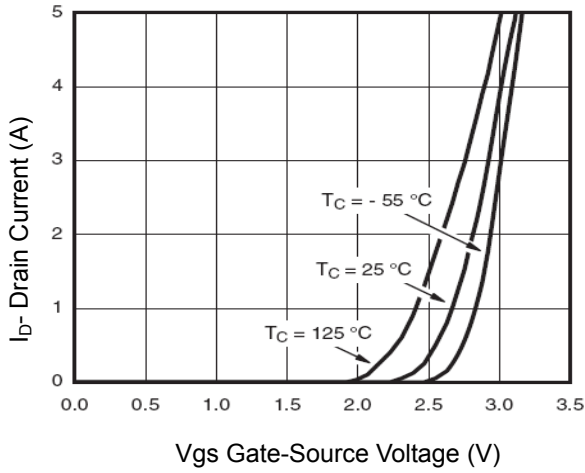

Figure 7 Transfer Characteristics

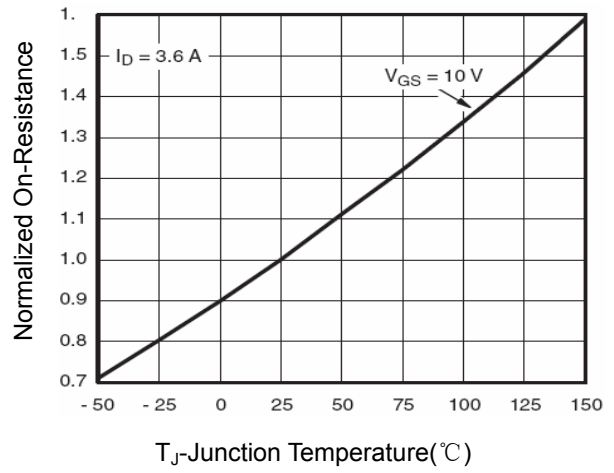

Figure 8 Drain-Source On-Resistance

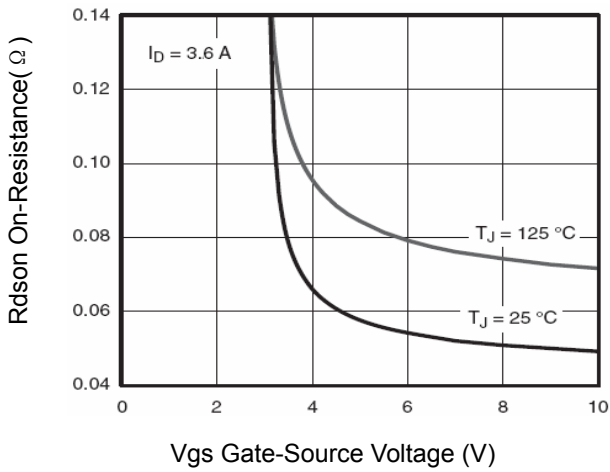

Figure 9 $R_{DS(on)}$ vs V_{GS}

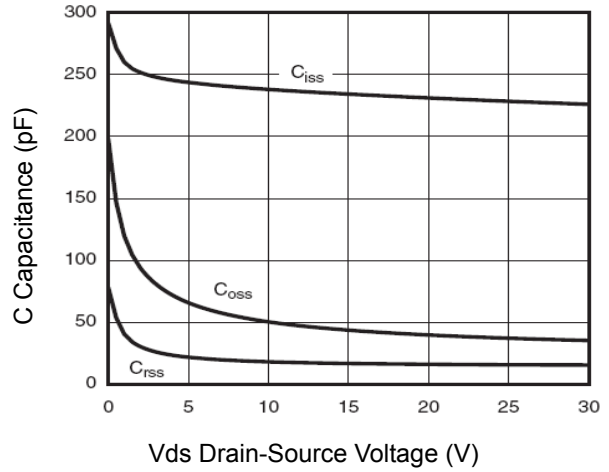

Figure 10 Capacitance vs V_{DS}

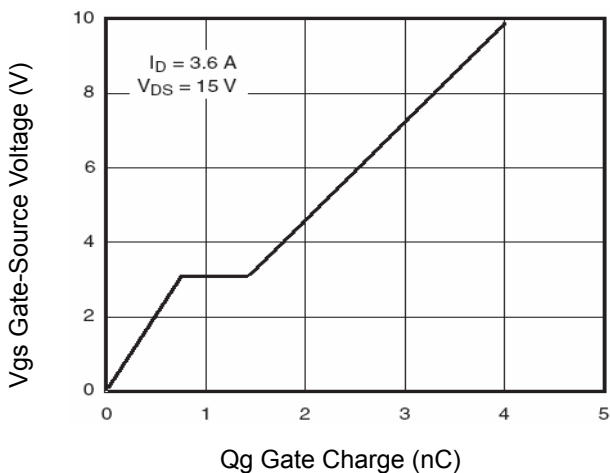

Figure 11 Gate Charge

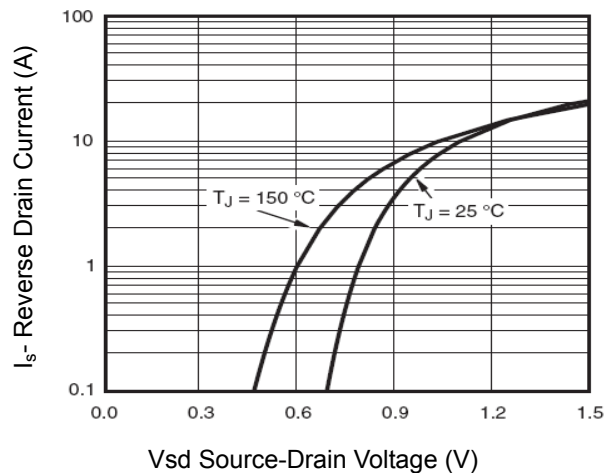

Figure 12 Source- Drain Diode Forward



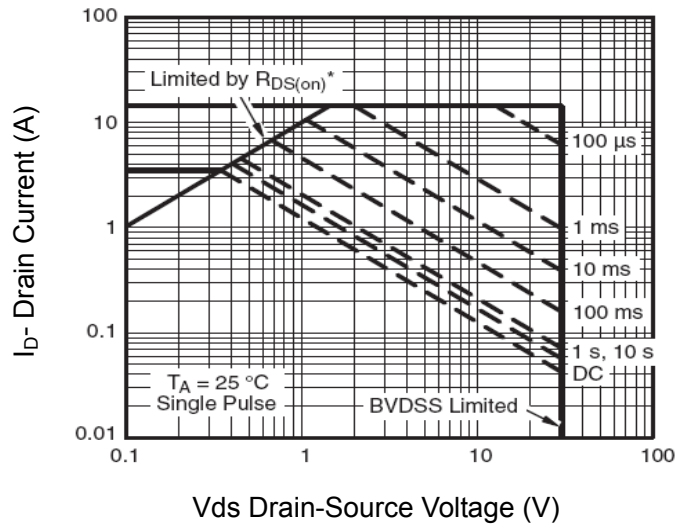

Figure 13 Safe Operation Area

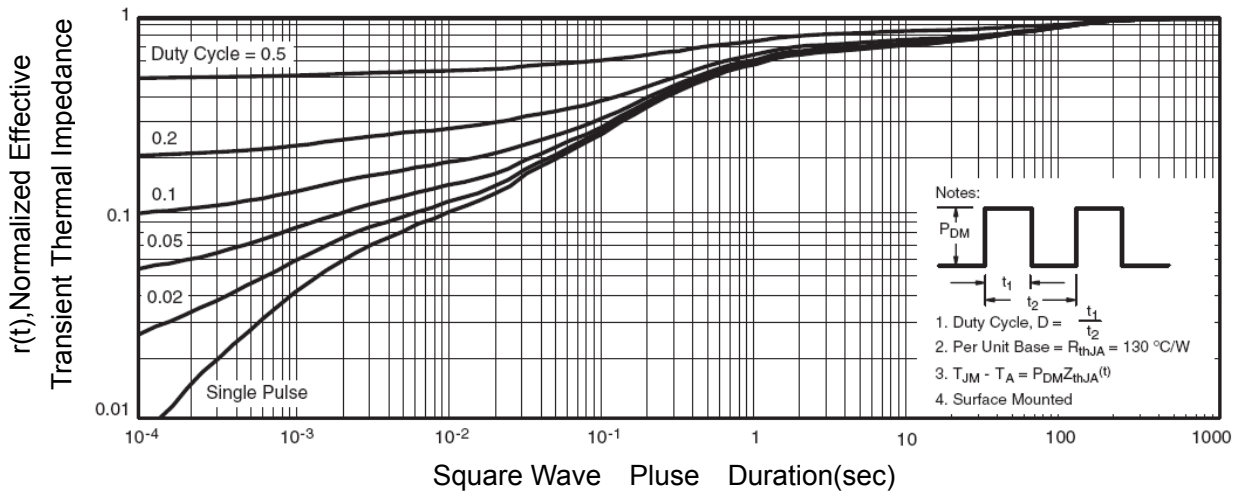

Figure 14 Normalized Maximum Transient Thermal Impedance



X-ON Electronics

Largest Supplier of Electrical and Electronic Components

Click to view similar products for [MOSFET](#) category:

Click to view products by [Shikues](#) manufacturer:

Other Similar products are found below :

[614233C](#) [648584F](#) [FDPF9N50NZ](#) [IRFD120](#) [IRFF430](#) [JANTX2N5237](#) [2N7000](#) [FCA20N60_F109](#) [FDZ595PZ](#) [2SK2267\(Q\)](#) [2SK2545\(Q,T\)](#)
[405094E](#) [423220D](#) [MIC4420CM-TR](#) [VN1206L](#) [614234A](#) [715780A](#) [SSM6J414TU,LF\(T](#) [751625C](#) [PSMN4R2-30MLD](#)
[TK31J60W5,S1VQ\(O](#) [2SK2614\(TE16L1,Q\)](#) [DMN1017UCP3-7](#) [EFC2J004NUZTDG](#) [FCAB21350L1](#) [P85W28HP2F-7071](#) [DMN1053UCP4-7](#)
[NTE2384](#) [NTE2969](#) [NTE6400A](#) [DMN61D9UWQ-13](#) [US6M2GTR](#) [DMN31D5UDJ-7](#) [SSM6P54TU,LF](#) [DMP22D4UFO-7B](#)
[IPS60R3K4CEAKMA1](#) [DMN1006UCA6-7](#) [DMN16M9UCA6-7](#) [STF5N65M6](#) [STU5N65M6](#) [C3M0021120D](#) [DMN13M9UCA6-7](#)
[BSS340NWH6327XTSA1](#) [MCM3400A-TP](#) [DMTH10H4M6SPS-13](#) [IPS60R1K0PFD7SAKMA1](#) [IPS60R360PFD7SAKMA1](#)
[IPS60R600PFD7SAKMA1](#) [IPS60R210PFD7SAKMA1](#) [DMN2990UFB-7B](#)