

Surface mount transient voltage suppressor power 600 watts

Stand-Off Voltage : 5.0V~440V

FEATURES

- For surface mounted applications in order to optimize board space.
- Low profile package
- Glass passivated junction
- Low inductance
- Plastic package has Underwriters Laboratory Flammability

MECHANICAL DATA

- Case: SMB
- Terminals: Solderable per MIL-STD-750, Method 2026
- Approx. Weight: 0.055g / 0.002oz

PINNING

PIN	DESCRIPTION
1	Cathode
2	Anode

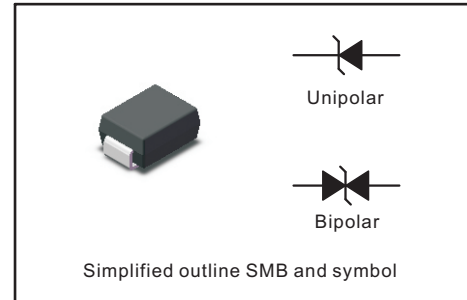

Maximum Ratings and Electrical characteristics

Ratings at 25 °C ambient temperature unless otherwise specified.

Parameter	Symbol	Value	Unit
Peak Pulse Power Dissipation on 10/1000 s waveform (Note1,Note2, Fig.1).	P_{PPM}	600	W
Peak Forward Surge Current,8.3ms Single Half Sine-Wave Superimposed on Rated Load, (JEDEC Method) (Note 3, Fig4).	I_{FSM} (UNI)	100	A
Peak Pulse Current on 10/1000 us waveform (Note 1, Fig 3)	I_{PPM}	see Table 1	A
Typical Junction capacitance at VR=4V, f=1MHz	C_J	390	pF
ESD Voltage per IEC6100-4-2	Contact Air	V_{ESD1} V_{ESD2}	± 30 ± 30 kV
Typical Thermal Resistance Junction to Ambient(Note 2)	$R_{\theta JA}$	100	°C/W
Operating Junction Temperature and Storage Temperature Range	T_j, T_{stg}	-65 ~ +150	°C

NOTES:

1. Non-repetitive current pulse, per Fig.3 and derated above $T_A = 25^\circ\text{C}$ per Fig. 2.
2. Mounted on 5 mm² (0.13mm thick) land areas.
3. Measured on 8.3ms, single half sine-wave or equivalent square wave, duty cycle=4 pulses per minute maximum.
4. Peak pulse power waveform is 10/1000μS.

Characteristics at Ta = 25°C										600W Transient Voltage Suppresso		Table 1	
Type		Reverse Stand-off Voltage	Breakdown Voltage		Test Current	Maximum Reverse Leakage	Max. Clamp Voltage	Peak Pulse Current	Package				
			V _{BR} @ I _T						SMB				
UNI	BI	V _{RMW}	Min	Max	I _T	µA	V _C @ I _{PP}	I _{PP}	UNI	BI			
SMBJ5.0A	SMBJ5.0CA	5	6.4	7	10	800	9.2	65.3	KE	AE			
SMBJ6.0A	SMBJ6.0CA	6	6.67	7.37	10	800	10.3	58.3	KG	AG			
SMBJ6.5A	SMBJ6.5CA	6.5	7.22	7.98	10	500	11.2	53.6	KK	AK			
SMBJ7.0A	SMBJ7.0CA	7	7.78	8.6	10	200	12.0	50.0	KM	AM			
SMBJ7.5A	SMBJ7.5CA	7.5	8.33	9.21	1	100	12.9	46.6	KP	AP			
SMBJ8.0A	SMBJ8.0CA	8	8.89	9.83	1	50	13.6	44.2	KR	AR			
SMBJ8.5A	SMBJ8.5CA	8.5	9.44	10.4	1	20	14.4	41.7	KT	AT			
SMBJ9.0A	SMBJ9.0CA	9	10	11.1	1	10	15.4	39.0	KV	AV			
SMBJ10A	SMBJ10CA	10	11.1	12.3	1	5	17.0	35.3	KX	AX			
SMBJ11A	SMBJ11CA	11	12.2	13.5	1	1	18.2	33.0	KZ	AZ			
SMBJ12A	SMBJ12CA	12	13.3	14.7	1	1	19.9	30.2	LE	BE			
SMBJ13A	SMBJ13CA	13	14.4	15.9	1	1	21.5	28.0	LG	BG			
SMBJ14A	SMBJ14CA	14	15.6	17.2	1	1	23.2	25.9	LK	BK			
SMBJ15A	SMBJ15CA	15	16.7	18.5	1	1	24.4	24.6	LM	BM			
SMBJ16A	SMBJ16CA	16	17.8	19.7	1	1	26.0	23.1	LP	BP			
SMBJ17A	SMBJ17CA	17	18.9	20.9	1	1	27.6	21.8	LR	BR			
SMBJ18A	SMBJ18CA	18	20	22.1	1	1	29.2	20.6	LT	BT			
SMBJ20A	SMBJ20CA	20	22.2	24.5	1	1	32.4	18.6	LV	BV			
SMBJ22A	SMBJ22CA	22	24.4	26.9	1	1	35.5	16.9	LX	BX			
SMBJ24A	SMBJ24CA	24	26.7	29.5	1	1	38.9	15.5	LZ	BZ			
SMBJ26A	SMBJ26CA	26	28.9	31.9	1	1	42.1	14.3	ME	CE			
SMBJ28A	SMBJ28CA	28	31.1	34.4	1	1	45.4	13.3	MG	CG			
SMBJ30A	SMBJ30CA	30	33.3	36.8	1	1	48.4	12.4	MK	CK			
SMBJ33A	SMBJ33CA	33	36.7	40.6	1	1	53.3	11.3	MM	CM			
SMBJ36A	SMBJ36CA	36	40	44.2	1	1	58.1	10.4	MP	CP			
SMBJ40A	SMBJ40CA	40	44.4	49.1	1	1	64.5	9.3	MR	CR			
SMBJ43A	SMBJ43CA	43	47.8	52.8	1	1	69.4	8.7	MT	CT			
SMBJ45A	SMBJ45CA	45	50	55.3	1	1	72.7	8.3	MV	CV			
SMBJ48A	SMBJ48CA	48	53.3	58.9	1	1	77.4	7.8	MX	CX			
SMBJ51A	SMBJ51CA	51	56.7	62.7	1	1	82.4	7.3	MZ	CZ			
SMBJ54A	SMBJ54CA	54	60	66.3	1	1	87.1	6.9	NE	DE			
SMBJ58A	SMBJ58CA	58	64.4	71.2	1	1	93.6	6.5	NG	DG			
SMBJ60A	SMBJ60CA	60	66.7	73.7	1	1	96.8	6.2	NK	DK			
SMBJ64A	SMBJ64CA	64	71.1	78.6	1	1	103.0	5.9	NM	DM			
SMBJ70A	SMBJ70CA	70	77.8	86	1	1	113.0	5.3	NP	DP			
SMBJ75A	SMBJ75CA	75	83.3	92.1	1	1	121.0	5.0	NR	DR			
SMBJ78A	SMBJ78CA	78	86.7	95.8	1	1	126.0	4.8	NT	DT			
SMBJ85A	SMBJ85CA	85	94.4	104	1	1	137.0	4.4	NV	DV			
SMBJ90A	SMBJ90CA	90	100	111	1	1	146.0	4.1	NX	DX			
SMBJ100A	SMBJ100CA	100	111	123	1	1	162.0	3.7	NZ	DZ			
SMBJ110A	SMBJ110CA	110	122	135	1	1	177.0	3.4	PE	EE			
SMBJ120A	SMBJ120CA	120	133	147	1	1	193.0	3.1	PG	EG			
SMBJ130A	SMBJ130CA	130	144	159	1	1	209.0	2.9	PK	EK			
SMBJ150A	SMBJ150CA	150	167	185	1	1	243.0	2.5	PM	EM			
SMBJ160A	SMBJ160CA	160	178	197	1	1	259.0	2.3	PP	EP			
SMBJ170A	SMBJ170CA	170	189	209	1	1	275.0	2.2	PR	ER			
SMBJ180A	SMBJ180CA	180	201	222	1	1	292.0	2.1	PT	ET			
SMBJ188A	SMBJ188CA	188	209	231	1	1	304.0	2.0	PB	EB			
SMBJ200A	SMBJ200CA	200	224	247	1	1	324.0	1.9	PV	EV			
SMBJ220A	SMBJ220CA	220	246	272	1	1	356.0	1.7	PX	EX			
SMBJ250A	SMBJ250CA	250	279	309	1	1	405.0	1.5	PZ	EZ			
SMBJ300A*	SMBJ300CA*	300	335	371	1	1	486.0	1.3	QE	FE			
SMBJ350A*	SMBJ350CA*	350	391	432	1	1	567.0	1.1	QG	FG			
SMBJ400A*	SMBJ400CA*	400	447	494	1	1	648.0	0.9	QK	FK			
SMBJ440A*	SMBJ440CA*	440	492	543	1	1	713.0	0.9	QM	FM			

Fig.1 Peak Pulse Power Rating Curve

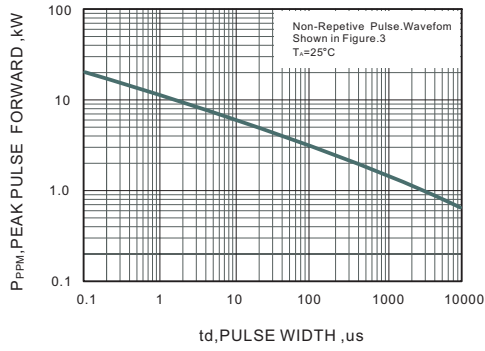

Fig.2 Forward Current Derating Curve

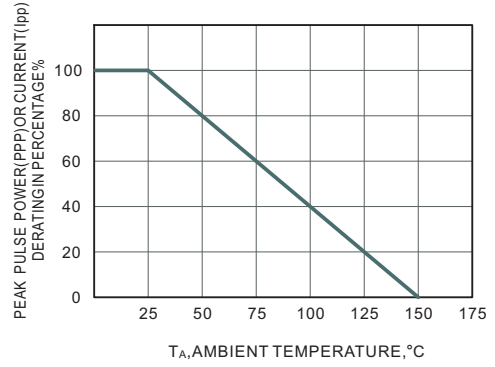

Fig.3 Pulse Waveform

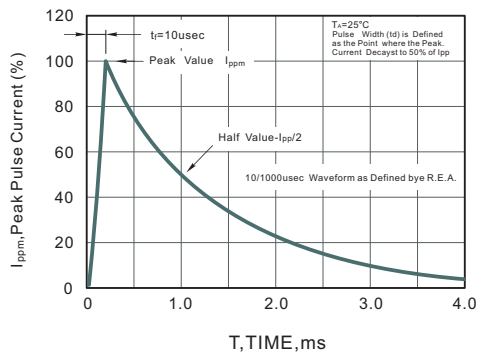
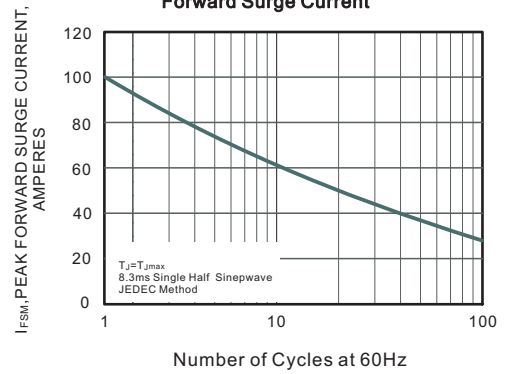

Fig.4 Maximum Non-Repetitive Peak Forward Surge Current



PACKAGE OUTLINE

Plastic surface mounted package; 2 leads

SMB

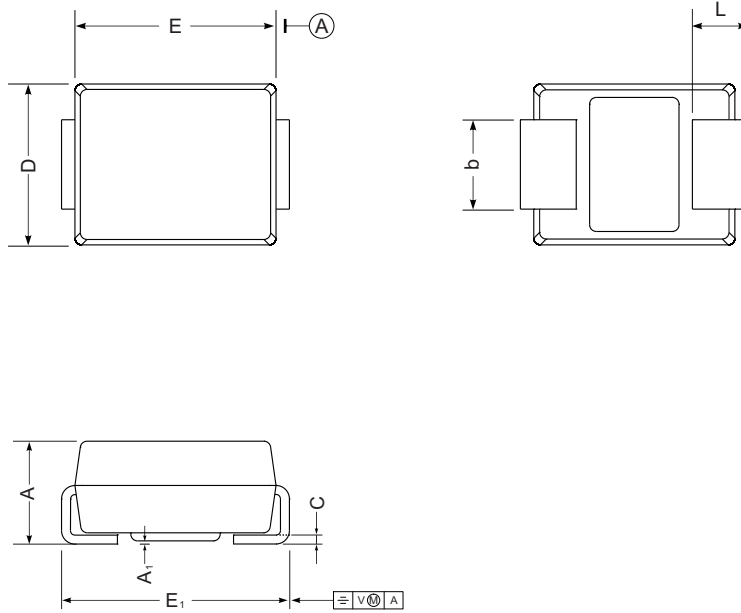

SMB mechanical data

UNIT		A	E	D	E ₁	A ₁	L	C	b
mm	max	2.44	4.70	3.94	5.59	0.20	1.5	0.305	2.11
	min	2.13	4.06	3.3	5.08	0.05	0.8	0.152	1.91
mil	max	96	185	155	220	7.9	59	12	83
	min	84	160	130	200	2.0	32	6	75

The recommended mounting pad size

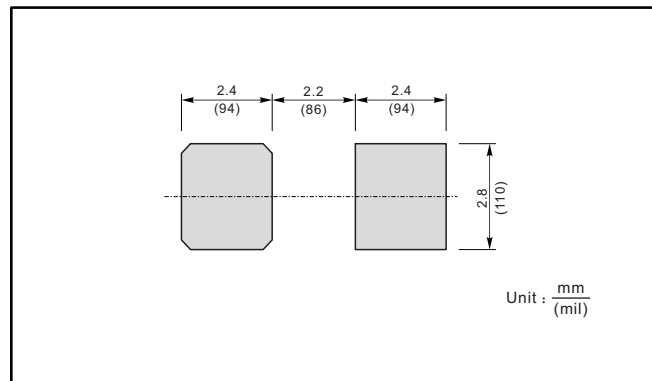

X-ON Electronics

Largest Supplier of Electrical and Electronic Components

Click to view similar products for [ESD Suppressors / TVS Diodes](#) category:

Click to view products by [Shikues](#) manufacturer:

Other Similar products are found below :

[NTE4902](#) [P4SMAJ15A](#) [P4SMAJ26A](#) [SMAJ400CA-TP](#) [TGL34-47CA](#) [ESDAULC45-1BF4](#) [SM1605E3/TR13](#) [SMF20A-TP](#) [P4SMAJ12A](#)
[CPDUR24V-HF](#) [CPDQC5V0USP-HF](#) [CPDQC5V0-HF](#) [MPLAD30KP45CAE3](#) [MMBZ27VCLQ-7-F](#) [MMAD1108/TR13](#) [MPLAD30KP24A](#)
[ACPDQC5V0R-HF](#) [DFLT170A-7](#) [NTE4900](#) [NTE4926](#) [NTE4938](#) [SMF22A-TP](#) [SMF12A-TP](#) [SLVU2.8-TP](#) [SMLJ6.5CA-TP](#) [SMAJ6.5CA-](#)
[TP](#) [MMAD1108E3/TR13](#) [D5V0M1U2LP3-7](#) [SMAJ400A-TP](#) [AOZ8811DT-03](#) [AOZ8831DI-05](#) [AOZ8831DT-03](#) [SMAJ188CA](#) [3SMC33CA](#)
[BK](#) [CPDQC3V3C-HF](#) [CPDQC12VE-HF](#) [MPLAD30KP170CA](#) [82357120100](#) [5.0SMLJ15CA-TP](#) [5KP18A-TP](#) [P6KE8.2A-TP](#)
[MPLAD30KP43CAE3](#) [SMAJ43A-TP](#) [D5V0F6U8LP33-7](#) [TVS5501V10MUT5G](#) [5.0SMLJ24CA-TP](#) [SMAJ110CA-TP](#) [MPLAD15KP75CAE3](#)
[MMAD1103e3/TR13](#) [DFLT40AQ-7](#)