

Surface mount transient voltage suppressor power 200 watts

Stand-Off Voltage : 5.0V~220V

## FEATURES

- For surface mounted applications in order to optimize board space.
- Low profile package
- Glass passivated junction
- Low inductance
- Plastic package has Underwriters Laboratory Flammability

## MECHANICAL DATA

- Case: SOD-123FL
- Terminals: Solderable per MIL-STD-750, Method 2026
- Approx. Weight: 15mg 0.00048oz

## PINNING

PIN	DESCRIPTION
1	Cathode
2	Anode

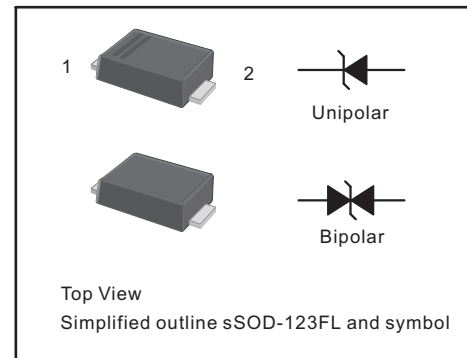

## Maximum Ratings and Electrical characteristics

Ratings at 25 °C ambient temperature unless otherwise specified.

Parameter	Symbol	Value	Unit
Peak Pulse Power Dissipation on TA=25°C (Note 1,2,5, Fig1)	$P_{PPM}$	200	W
Peak Forward Surge Current (Note 3)	$I_{FSM}$ (UNI)	20	A
Peak Pulse Current on 10/1000 us waveform (Note 1) Fig 2	$I_{PPM}$	see Table 1	A
Steady State Power Dissipation (Note 4)	$P_{M(AV)}$	1	W
Operating Junction and Storage Range	$T_J, T_{STG}$	-55 to +150	°C
Typical Thermal Resistance	$R_{\theta JA}$	180	°C

## NOTES

1. Non-repetitive current pulse per Fig 3 and derated above  $T_A=25^\circ\text{C}$  per Fig 2
2. Mounted on 5mm<sup>2</sup> copper pads to each terminal
3. 8.3ms single half sinewave, or equivalent square wave duty cycle=4 pulses per minutes maximum
4. lead temperature at  $T_L=75^\circ\text{C}$
5. Peak pulse powe. waveform is  $t_p=10/1000\text{us}$
6. A transient suppressor is selected according to the working peak reverse voltage( $V_{RWM}$ ), Which Should be equal to or greater than the DC or continuous peak operating voltage level

Type		Marking		V <sub>RWM</sub>	Breakdown Voltage		Test Current	Reverse Leakage	Max. Clamp Voltage	Peak Pulse Current
					V <sub>BR</sub> @ I <sub>T</sub>					
					Min	Max	I <sub>T</sub>	I <sub>R</sub> @ V <sub>RWM</sub>	V <sub>C</sub> @ I <sub>PP</sub>	I <sub>PP</sub>
Uni	Bi	Uni	Bi	V	V	V	mA	µA	V	A
SMF5.0A	SMF5.0CA	AE	CAE	5	6.4	7	10	200	9.2	21.7
SMF6.0A	SMF6.0CA	AG	CAG	6	6.67	7.37	10	100	10.3	19.4
SMF6.5A	SMF6.5CA	AK	CAK	6.5	7.22	7.98	10	75	11.2	17.9
SMF7.0A	SMF7.0CA	AM	CAM	7	7.78	8.6	10	50	12	16.7
SMF7.5A	SMF7.5CA	AP	CAP	7.5	8.33	9.21	1	50	12.9	15.5
SMF8.0A	SMF8.0CA	AR	CAR	8	8.89	9.83	1	25	13.6	14.7
SMF8.5A	SMF8.5CA	AT	CAT	8.5	9.44	10.4	1	10	14.4	13.9
SMF9.0A	SMF9.0CA	AV	CAV	9	10	11.1	1	5	15.4	13
SMF10A	SMF10CA	AX	CAX	10	11.1	12.3	1	2.5	17	11.8
SMF11A	SMF11CA	AZ	CAZ	11	12.2	13.5	1	2.5	18.2	11
SMF12A	SMF12CA	BE	CBE	12	13.3	14.7	1	2.5	19.9	10.1
SMF13A	SMF13CA	BG	CBG	13	14.4	15.9	1	1	21.5	9.3
SMF14A	SMF14CA	BK	CBK	14	15.6	17.2	1	1	23.2	8.6
SMF15A	SMF15CA	BM	CBM	15	16.7	18.5	1	1	24.4	8.2
SMF16A	SMF16CA	BP	CBP	16	17.8	19.7	1	1	26	7.7
SMF17A	SMF17CA	BR	CBR	17	18.9	20.9	1	1	27.6	7.2
SMF18A	SMF18CA	BT	CBT	18	20	22.1	1	1	29.2	6.8
SMF20A	SMF20CA	BV	CBV	20	22.2	24.5	1	1	32.4	6.2
SMF22A	SMF22CA	BX	CBX	22	24.4	26.9	1	1	35.5	5.6
SMF24A	SMF24CA	BZ	CBZ	24	26.7	29.5	1	1	38.9	5.1
SMF26A	SMF26CA	CE	CCE	26	28.9	31.9	1	1	42.1	4.8
SMF28A	SMF28CA	CG	CCG	28	31.1	34.4	1	1	45.4	4.4
SMF30A	SMF30CA	CK	CCK	30	33.3	36.8	1	1	48.4	4.1
SMF33A	SMF33CA	CM	CCM	33	36.7	40.6	1	1	53.3	3.8
SMF36A	SMF36CA	CP	CCP	36	40	44.2	1	1	58.1	3.4
SMF40A	SMF40CA	CR	CCR	40	44.4	49.1	1	1	64.5	3.1
SMF43A	SMF43CA	CT	CCT	43	47.8	52.8	1	1	69.4	2.9
SMF45A	SMF45CA	CV	CCV	45	50	55.3	1	1	72.7	2.8
SMF48A	SMF48CA	CX	CCX	48	53.3	58.9	1	1	77.4	2.6
SMF51A	SMF51CA	CZ	CCZ	51	56.7	62.7	1	1	82.4	2.4
SMF54A	SMF54CA	DE	CDE	54	60	66.3	1	1	87.1	2.3
SMF58A	SMF58CA	DG	CDG	58	64.4	71.2	1	1	93.6	2.1
SMF60A	SMF60CA	DK	CDK	60	66.7	73.7	1	1	96.8	1.8
SMF64A	SMF64CA	DM	CDM	64	71.1	78.6	1	1	103	1.7
SMF70A	SMF70CA	DP	CDP	70	77.8	86	1	1	113	1.5
SMF75A	SMF75CA	DR	CDR	75	83.3	92.1	1	1	121	1.4
SMF78A	SMF78CA	DT	CDT	78	86.7	95.8	1	1	126	1.4
SMF85A	SMF85CA	DV	CDV	85	94.4	104	1	1	137	1.3
SMF90A	SMF90CA	DX	CDX	90	100	111	1	1	146	1.2
SMF100A	SMF100CA	DZ	CDZ	100	111	123	1	1	162	1.1
SMF110A	SMF110CA	EE	CEE	110	122	135	1	1	177	1
SMF120A	SMF120CA	EG	CEG	120	133	147	1	1	193	0.9
SMF130A	SMF130CA	EK	CEK	130	144	159	1	1	209	0.8
SMF150A	SMF150CA	EM	CEM	150	167	185	1	1	243	0.7
SMF160A	SMF160CA	EP	CEP	160	178	197	1	1	259	0.7
SMF170A	SMF170CA	ER	CER	170	189	209	1	1	275	0.6
SMF180A	SMF180CA	ET	CET	180	201	222	1	1	292	0.5
SMF200A	SMF200CA	EX	CEX	200	224	247	1	1	324	0.5
SMF220A	SMF220CA	E22	CE22	220	246	272	1	1	356	0.5

**Fig.1 Peak Pulse Power Rating Curve**

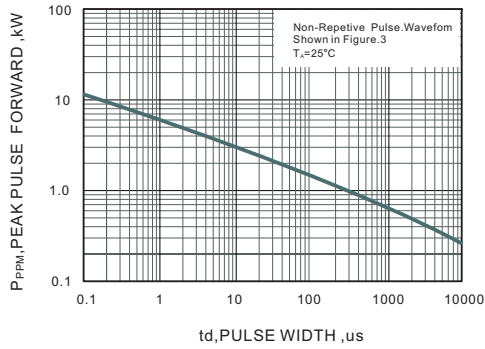

**Fig.2 Forward Current Derating Curve**

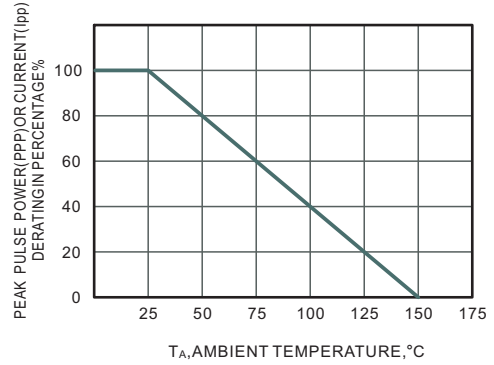

**Fig.3 Pulse Waveform**

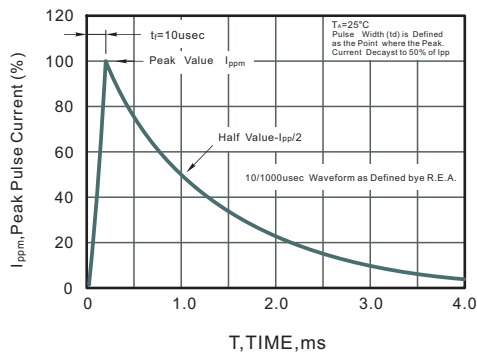

**Fig.4 Maximum Non-Repetitive Peak Forward Surge Current**

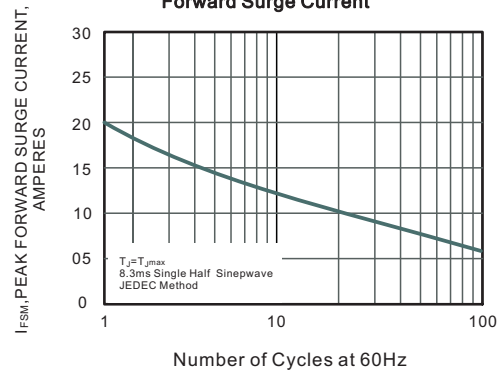

## PACKAGE OUTLINE

Plastic surface mounted package; 2 leads

SOD-123FL

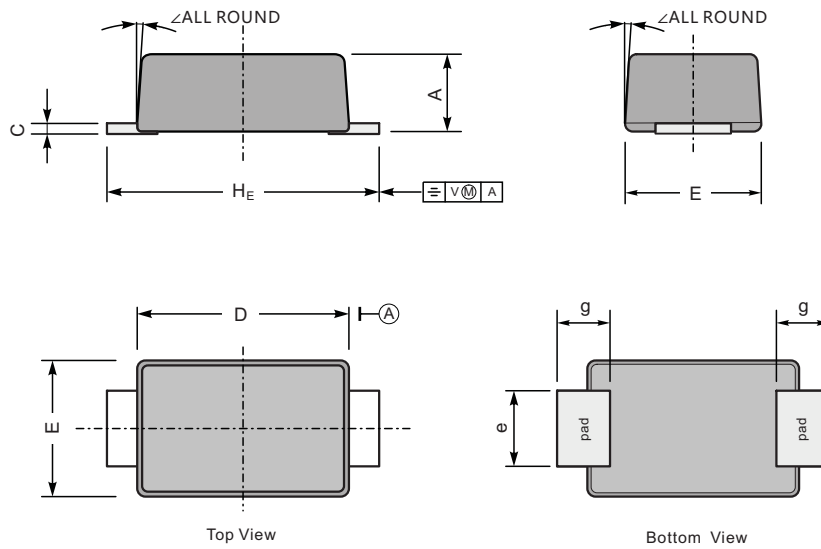

UNIT		A	C	D	E	e	g	H <sub>E</sub>	$\angle$
mm	max	1.1	0.20	2.9	1.9	1.1	0.9	3.8	7°
	min	0.9	0.12	2.6	1.7	0.8	0.7	3.5	
mil	max	43	7.9	114	75	43	35	150	
	min	35	4.7	102	67	31	28	138	

### The recommended mounting pad size

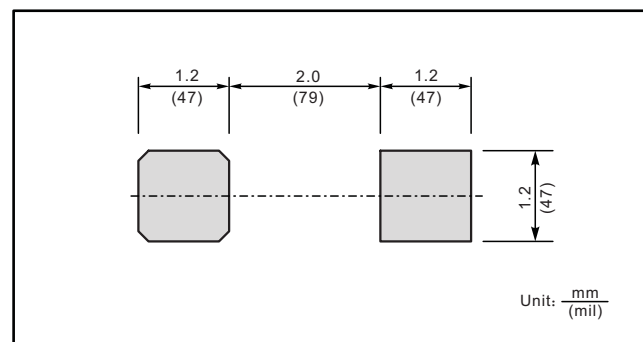

## X-ON Electronics

Largest Supplier of Electrical and Electronic Components

*Click to view similar products for [ESD Suppressors / TVS Diodes](#) category:*

*Click to view products by [Shikues](#) manufacturer:*

Other Similar products are found below :

[60KS200C](#) [D18V0L1B2LP-7B](#) [D5V0F4U5P5-7](#) [NTE4902](#) [P4KE27CA](#) [P6KE11CA](#) [P6KE39CA-TP](#) [P6KE8.2A](#) [JANTX1N6053A](#)  
[SA110CA](#) [SA60CA](#) [SA64CA](#) [SMBJ12CATR](#) [SMBJ33CATR](#) [SMBJ8.0A](#) [ESD101-B1-02ELS E6327](#) [ESD105-B1-02EL E6327](#) [ESD112-B1-02EL E6327](#) [ESD119B1W01005E6327XTSA1](#) [ESD5V0L1B02VH6327XTSA1](#) [ESD7451N2T5G](#) [19180-510](#) [CPDT-5V0USP-HF](#)  
[3.0SMCJ33CA-F](#) [3.0SMCJ36A-F](#) [HSPC16701B02TP](#) [JANTX1N6126A](#) [JANTX1N6462](#) [JANTX1N6465](#) [USB50805e3/TR7](#)  
[D3V3Q1B2DLP3-7](#) [D55V0M1B2WS-7](#) [DRTR5V0U4SL-7](#) [SCM1293A-04SO](#) [ESD200-B1-CSP0201 E6327](#) [SM12-7](#) [SM1605E3/TR13](#)  
[SMLJ45CA-TP](#) [CEN955 W/DATA](#) [82350120560](#) [VESD12A1A-HD1-GS08](#) [CPDUR5V0R-HF](#) [CPDQC5V0U-HF](#) [CPDQC5V0USP-HF](#)  
[CPDQC5V0-HF](#) [D1213A-01LP4-7B](#) [ESD101-B1-02EL E6327](#) [824500181](#) [MMAD1108/TR13](#) [5KP100A](#)