

Rating	20A 250VAC			Circuit Diagram Nil
Insulation Resistance	DC 500V 100M ohm Min.			
Dielectric Strength	AC 1500V 1 minute			
Fuse Size	$\phi 6.35 \times 30\text{mm}$ $\phi 6.35 \times 31.8\text{mm}$			

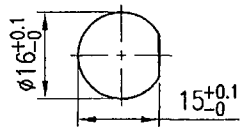

Material:
 Frame : NYLON#66,Black
 Top cap : NYLON#66,Black
 Terminals : Copper alloy, silver plated

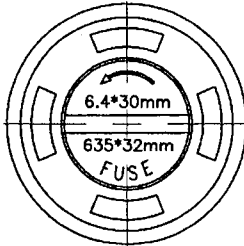
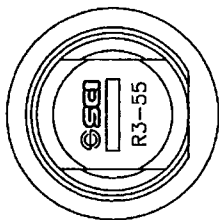
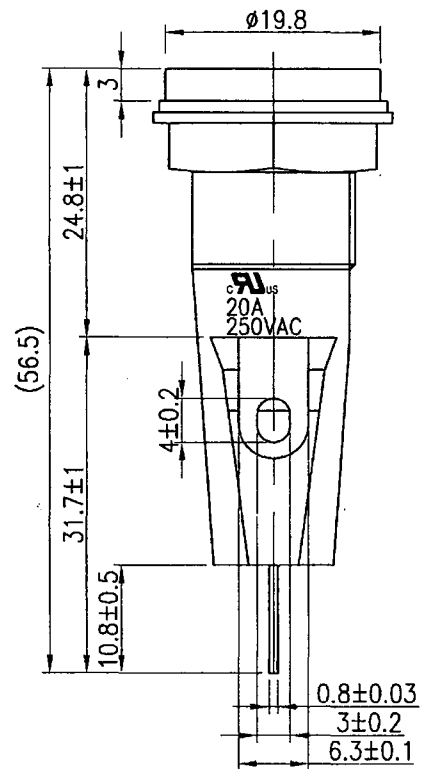
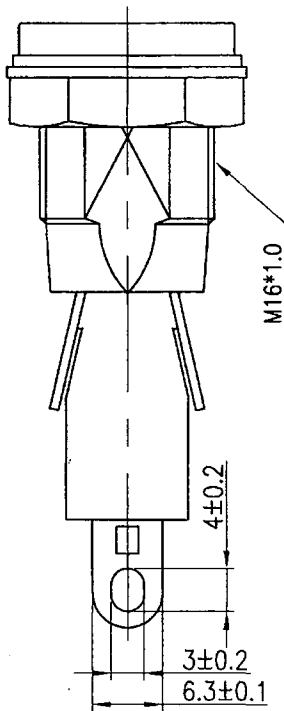
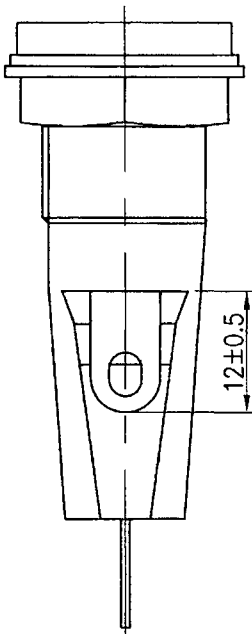

Tolerances ± 0.3 Unless Otherwise Specified

Date	Name	Description				No.
09/24/19	袁浩徐	Approved	SCI BOM No.	131-937	Model Name	FUSE HOLDER
		<i>Simon</i>	Customer No.	112-R3-55B	Model No.	R3-55B
		10/8-19	Unit	mm	Shin Chin Industrial Co., Ltd.	



Rev. 0

X-ON Electronics

Largest Supplier of Electrical and Electronic Components

Click to view similar products for [Fuse Holder](#) category:

Click to view products by [Shin Chin](#) manufacturer:

Other Similar products are found below :

[570-290-741P40](#) [0031.1351.01](#) [020417G](#) [020418E](#) [6R30A1B](#) [6SC30A2IC](#) [80910030](#) [80910080](#) [8601.2020](#) [9-3557-GP REV A](#) [HDJ-B](#)
[R6J30A3S](#) [HFH-1](#) [RF30A1S](#) [RF30A2B](#) [RF30A3SP](#) [15600-08-10](#) [BK/HHM](#) [HTJ-LES-FUSE](#) [C4044-1](#) [2193](#) [RTMF-SC](#) [2602](#) [2650](#)
[F60A2SQ](#) [FHN31G1](#) [T30A2B](#) [G4PB8](#) [2660](#) [CQ-209V](#) [HKP-CCHH](#) [R6F30A2S](#) [341001A](#) [345621A](#) [348670](#) [CVRMCC](#) [4202](#) [4407](#) [4408](#)
[4423](#) [4532](#) [4537](#) [TSD1404-12](#) [BPHHU](#) [HPC](#) [55900008011](#) [345602-010](#) [345603-010](#) [345612](#) [345903A](#)