

Package Outline

* = Similar Package

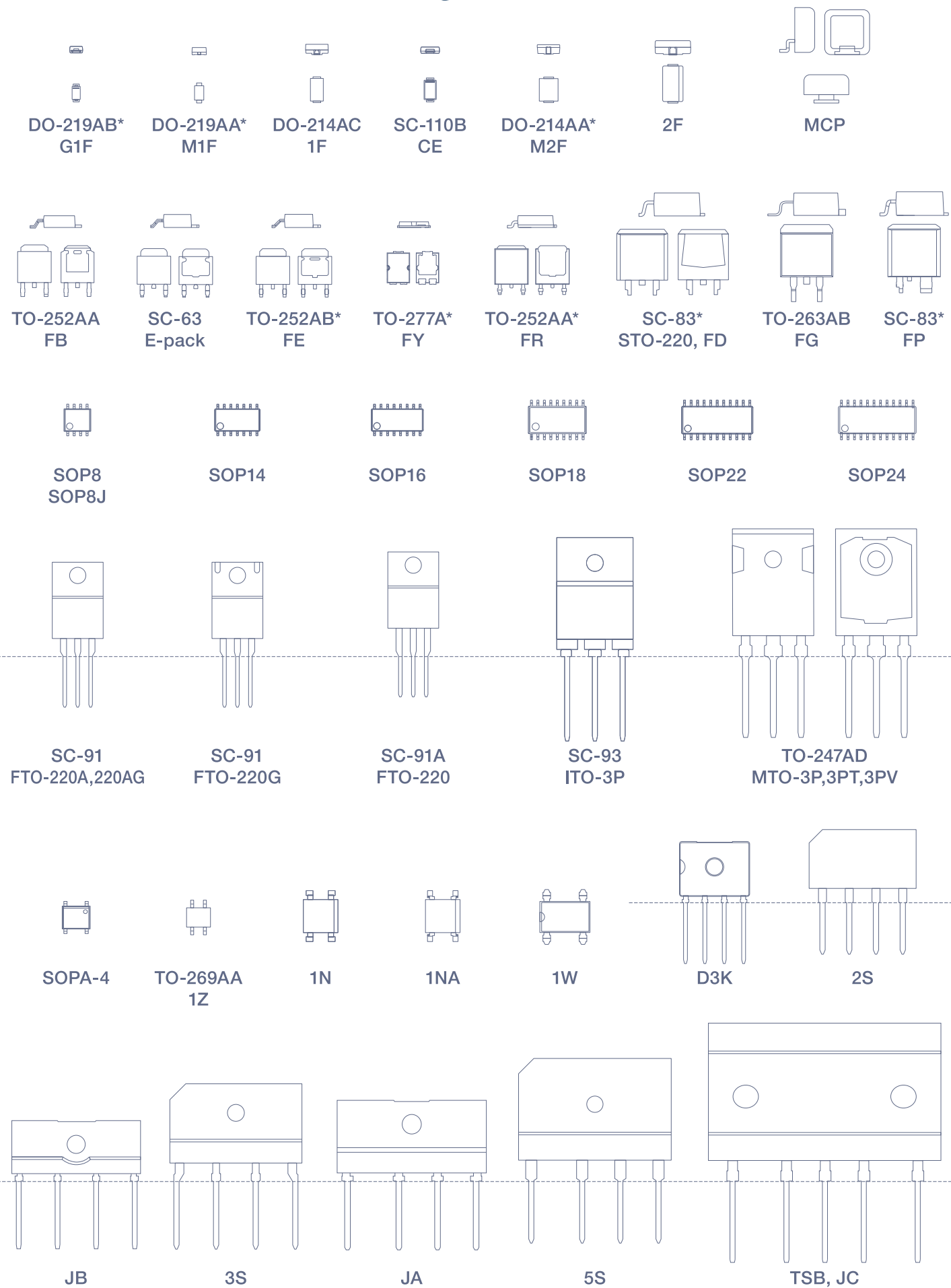

Semiconductor Product Catalog

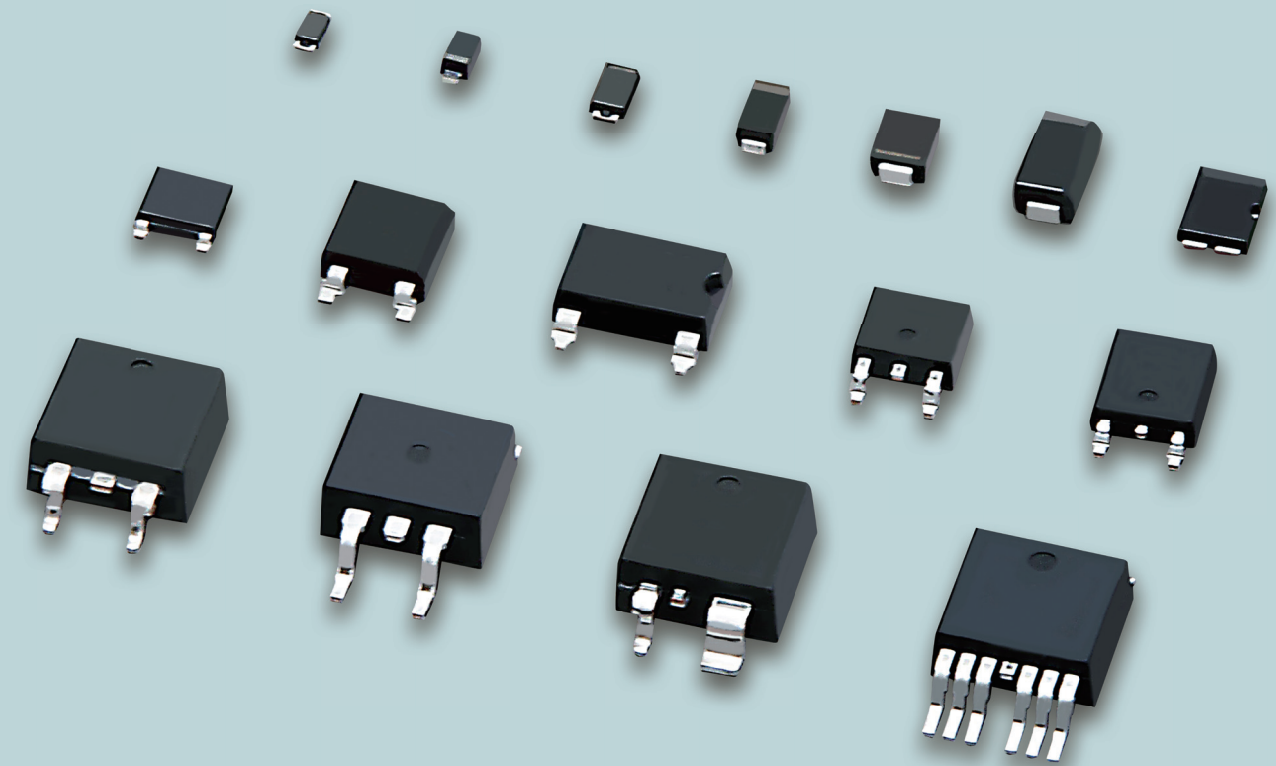

Shindengen Electric Manufacturing Co., Ltd.
www.shindengen.co.jp



CAT.NO.F072-13

1901-3500(1)

ShinDengen
New power. Your power.

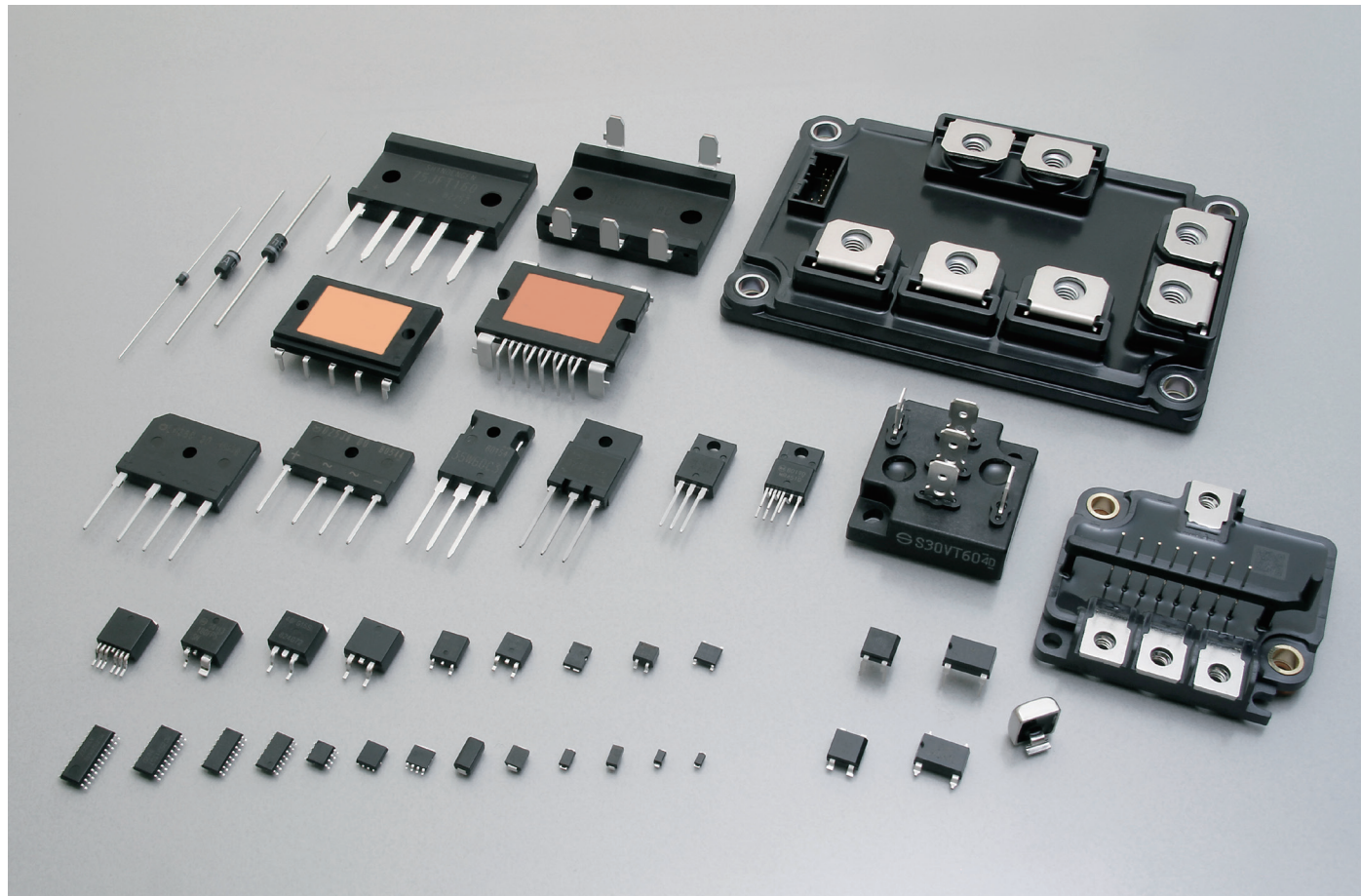

Notes

- ⚠ If you wish to use any such product, please be sure to refer to the specifications issued by Shindengen.
- ⚠ All products described or contained herein are designed with a quality level intended for use in standard applications requiring an ordinary level of reliability. If these products are to be used in equipment or devices for special or specific applications requiring an extremely high grade of quality or reliability in which failures or malfunctions of products may directly affect human life or health, a local Shindengen office must be contacted in advance to confirm that the intended use of the product is appropriate. Shindengen products are grouped into the following three applications according to the quality grade.
 - Standard applications
Computers, office automation and other office equipment, communication terminals, test and measurement equipment, audio/visual equipment, amusement equipment, consumer electronics, machine tools, personal electronic equipment, industrial equipment, etc.
 - Special applications
Transportation equipment (vehicles, ships, etc.), trunk-line communication equipment, traffic signal control systems, anti-disaster/crime systems, safety equipment, medical equipment, etc.
 - Specific applications
Nuclear reactor control systems, aircraft, aerospace equipment, submarine repeaters, life support equipment and systems, etc.
- ⚠ Although Shindengen continuously endeavors to enhance the quality and reliability of its products, customers are advised to consider and take safety measures in their design, such as redundancy, fire containment and anti-failure, so that personal injury, fires, or societal damages can be prevented.
- ⚠ Please note that all information described or contained herein is subject to change without notice due to product upgrades and other reasons. When buying Shindengen products, please contact the Company's offices or distributors to obtain the latest information.
- ⚠ Shindengen shall not bear any responsibility with regards to damages or infringement of any third-party patent rights and other intellectual property rights incurred due to the use of information on this website.
- ⚠ The information and materials on this website neither warrant the use of Shindengen's or any third party's patent rights and other intellectual property rights, nor grant license to such rights.
- ⚠ In the event that any product described or contained herein falls under the category of strategic products controlled under the Foreign Exchange and Foreign Trade Control Law of Japan, exporting of such products shall require an export license from the Japanese government in accordance with the above law.
- ⚠ No reprinting or reproduction of the materials on this website, either in whole or in part, is permitted without proper authorization from Shindengen.

SALES OFFICES

U.S.A.

Shindengen America, Inc. www.shindengen.com/

2333 Waukegan Road Suite250, Bannockburn, IL.60015. U.S.A
Phone:+1-847-444-1363 FAX:+1-847-444-0654

Europe

Shindengen UK Ltd. www.shindengen.co.eu/

Head Office

Unit 1, 1 Tapper Walk, King's Cross, London, N1C 4AQ U.K.
Phone:+44-20-3829-6980 FAX:+44-20-3725-6855

German Branch

Prinzenallee 1, 40549 Düsseldorf, Germany
Phone:+49-211-5206-590 FAX:+49-211-4986-499

Asia

Shindengen Singapore PTE Ltd.

750d, Chai Chee Road, #05-01,
Viva Business Park, Singapore 469004
Phone:+65-6445-0082 FAX:+65-6445-6089

Shindengen (H.K.) Co., Ltd.

Head Office

Suite 2006B, 20/F., Exchange Tower, 33 Wang Chiu Road,
Kowloon Bay, HK
Phone:+852-2317-1884 FAX:+852-2314-8561

Taiwan Representative Office

20Fl, No.85, Sec.1, Jhongsiao E. Road, Taipei, 10049,
Taiwan, R.O.C.
Phone:+886-2-2321-3990 FAX:+886-2-2358-3991

Shindengen (SHANGHAI) Electric Co., Ltd.

Room1506, Sheng Gaolnt'l Building, 137 Xian Xia Road,
Chang Ning, Shanghai, China
Phone:+86-21-6270-8000 FAX:+86-21-6270-0419

Shindengen Electric Mfg. Co., Ltd.

Seoul Office

B701-4. 230, Simin-daero, Dongan-gu, Anyang-si,
Gyeonggi-do, 14067 Korea
Phone:+82-31-385-1431 FAX:+82-31-385-1430

Japan

Shindengen Electric MFG. Co., Ltd. www.shindengen.co.jp/

Head Office

New-Ohtemachi Bldg., 2-2-1, Ohtemachi, Chiyoda-ku,
Tokyo 100-0004, Japan
Phone:+81-3-3279-4431 FAX:+81-3-3279-6478

Osaka Branch Office

Minami Senba Heart Bldg., 2-3-2, Minami-Senba,
Chuo-ku, Osaka City, Osaka 542-0081, Japan
Phone:+81-6-6264-7770 FAX:+81-6-6260-1222

Nagoya Branch Office

Nagoya Daiichi Bldg., 1-19-24, Nishiki, Naka-ku,
Nagoya City, Aichi 460-0003, Japan
Phone:+81-52-221-1361 FAX:+81-52-201-4780

Hamamatsu branch

Hamamatsu Daiichi Seimei Nittsu Bldg., 110-5, Itaya-cho,
Naka-ku, Hamamatsu City, Shizuoka 430-0928, Japan
Phone:+81-53-450-3800 FAX:+81-53-450-3801

Utsunomiya Sales Office

Flora Bldg., 1-9-15 Higashi Syukugou Utsunomiya City,
Tochigi 321-0953, Japan
Phone:+81-28-637-3615 FAX:+81-28-637-3115

- All specifications are subject to change without notice.
- Please consult us for the latest specifications before you order.
- Please use this products after reading manual well.

• Printed January 2020

This catalog includes the products which might be subject to the foreign exchange and foreign trade laws.

P3-6	INDEX
P7-10	GENERAL RECTIFYING DIODES
P11-20	BRIDGE DIODES
P21-30	SCHOTTKY BARRIER DIODES
P31-36	FAST RECOVERY DIODES
P37-38	THYRISTORS
P39-40	SIDACs
P41-42	TRIACs
P43-44	SURGE ABSORBERS
P45-48	TVS (Transient Surge Suppressor)
P49-54	POWER MOSFETs
P55-56	POWER MODULES
P57-60	POWER ICs
P61-82	PACKAGE LIST • OUTLINE DIMENSIONS
P83-84	PACKING SPECIFICATION
P85	NOTES • How to Order • Outline of Packing Form • About AEC-Q101 & Automotive Grade

INDEX

Type No.	Page	Type No.	Page	Type No.	Page	Type No.	Page	Type No.	Page	Type No.	Page	Type No.	Page	Type No.	Page
D1F60	8	D3CE4S	22	D8JBB80V	14	D25JAB60V	14	DE5LC20U	34	DG1S6	22	KD8SF60	42	M3F60	8
D1F60A	8	D3CE6S	22	D10FDC10ST	26	D25JAB80V	14	DE5S4M	22	DG1S6A	22	KD12SF60	42	M3FE40	8
D1FE60	8	D3CE15ST	22	D10FR60LA	32			DE5S6M	22	DL04-18F1	46	KD16SF60	42	M3FE60	8
D1FH3	22	D3CE20LUS	32	D10FR60V	8			DE5S3ML	26	DL04-33F1	46	KD20SF60	42	M3FL20U	32
D1FJ4	22	D3CE60K	32	D10FY4R5ST	22	D25XB60	14	DE5SC4M	26	DL04-36F1	46	KL3L07	44	MCZ5203SE	60
D1FJ8	22	D3CE60V	8	D10FY4R5SY	22	D25XB80	14	DE5SC6M	26	G1V(A)8C	40	KL3N14	44	MCZ5205SE	60
D1FJ8A	22	D3CE60VE	8	D10FY6ST	22	D25XB100	14	DE5VE40	8	G1V(A)10C	40	KL3R20	44	MCZ5207SG	60
D1FJ10	22	D3F60	8	D10FY6SY	22	D30FD60K	32	DE10S3L	22	G1V(A)12C	40	KL3Z07	44	MCZ5208SG	60
D1FK60	32	D3FE60	8	D10FY10ST	22	D30FDC4S	26	DE10S3L	22	G1V(A)13C	40	KL3Z18	44	MCZ5209SN	60
D1FK70	32	D3FJ10	22	D10FY10SY	22	D30FDC10ST	26	DE10SC3L	26	G1V(A)14C	40	KP20NU11	44	MCZ5211ST	60
D1FK100	32	D3FK60	32	D10FY15ST	22	D30FDC15ST	26	DE10SC4	26	G1V(A)15C	40	KP40NU11	44	MCZ5216ST	60
D1FK120	32	D3FS4A	22	D10FY60VE	8	D30JCB100K	18	DF5VD60	10	G1V(A)20C	40	KP40RU22	44	MCZ5303SG	60
D1FK120P	32	D3FS6	22	D10JBB60V	14	D30JCT120V	16	DF8L60US	32	G1V(B)20C	40	KU4F8	44	MCZ5303SH	60
D1FL20U	32	D3S4M	24	D10JBB80V	14			DF10L60	32	G1V(B)22C	40	KU4F12	44	MCZ5601SC	60
D1FL40U	32	D3S6M	24	D10SBS4	18			DF10LC20U	34	G1V(B)24C	40	KU5S31NS	44	MG020200	56
D1FM3	22	D3SB60	14	D10XB60	14	D30VC60	10	DF10LC30	34	G1VL8C	40	KU10L08	44	MG020201	56
D1FS4	22	D3SB80	14	D10XB60H	14	D30XBN20	18	DF10NC15	26	G1VL10C	40	KU10N14	44	MG031B090004A	56
D1FS4A	22	D3SBA60	14	D10XB80	14	D30XT80	16	DF10SC4M	26	G1VL15C	40	KU10NU11	44	MG031E120004A	56
D1FS6	22	D4F60	8	D15FR4ST	22	D35XB80	14	DF10SC6	26	G1VL20C	40	KU10NU13	44	MG031G148004A	56
D1FS6A	22	D4SB60L	14	D15FR60LA	32	D40FDC10ST	26	DF10SC9	26	G1VL22C	40	KU10R23NS	44	MG031L080006A	56
D1FT4	22	D4SB80	14	D15FR60V	8	D40FDC15ST	26	DF15JC10	26	G1VL24C	40	KU10R27NS	44	MG031MC148004A	56
D1FT4A	22	D4SBL20U	18	D15FY4R5ST	22	D45JCT120V	16	DF15NC15	26	K1V10	40	KU10R29NS	44	MG031MD110006A	56
D1FT6	22			D15FY4R5SY	22	D45JCT160V	16	DF15SC4M	26	K1V11	40	KU10S31NS	44	MG031N110006A	56
D1FT6A	22	D4SBN20	18	D15FY6ST	22	D45XT80	16	DF15VD60	10	K1V12	40	KU10S35NS	44	MG032A4207R5A	56
D1FT10	22	D4SBS4	18	D15FY6SY	22	D45XT160	16	DF16VC60R	10	K1V14	40	KU15N14	44	MG032B420010A	56
D1FT10A	22	D4SBS6	18	D15FY10ST	22	D50JCB80V	14	DF20JC10	26	K1V22	40	LL15XB60	20	MG038A200080A	18
D1FT15A	22	D5CE4S	22	D15FY10SY	22	D50XB80	14	DF20L60	32	K1V22(W)	40	LL25XB60	20	MG038B150080A	18
D1N60	8	D5FE60	8	D15FY15ST	22	D70JHB80V	14	DF20L60U	32	K1V24	40	LN1F60	8	MG038C200160A	18
D1N80	8	D5FY4R5ST	22	D15JAB60V	14	D75JFT80V	16	DF20LC20US	34	K1V24(W)	40	LN1WBA60	20	MG038D150160A	18
D1NF60	32	D5FY4R5SY	22	D15JAB80V	14	D100JHT80V	16	DF20LC30	34	K1V26	40	LN4SB60	20	MG048A150004A	56
D1NK60	32	D5FY6ST	22	D15XB60	14	D100JHT120V	16	DF20NC15	26	K1V26(W)	40	LN6SB60	20	MG048B100006A	56
D1NK100	32	D5FY6SY	22	D15XB60H	14	D100JHT160V	16	DF20SC4M	26	K1V36(W)	40	LN15XB60	20	MH2501SC	60
D1NL20U	32	D5FY10ST	22	D15XB80	14			DF20SC9M	26	K1V38(W)	40	LN15XB60H	20	MH2511SC	60
D1NL40U	32	D5FY10SY	22	D15XB100	14			DF25SC6M	26	K1V(A)10	40	LN25XB60	20	MS1003SH	60
D1NS4	24	D5FY15ST	22	D15XBN20	18	D120SC4M	30	DF25V60	8	K1V(A)11	40	M1F60	8	MS1004SH	60
D1NS6	24	D5FY60K	32	D15XBS6	18	D120SC6M	30	DF30JC4	26	K1V(A)12	40	M1F80	8	MS1005SK	60
D1UBA80	12	D5SB60	14	D20FD60LU	32	D180SC4M	30	DF30JC6	26	K1V(A)16	40	M1FE40	8	MS1006SK	60
D2F60	8	D5SB80	14	D20FDC10ST	26	D180SC6M	30	DF30JC10	26	K1VZL09	40	M1FE60	8	MS1007SH	60
D2FK60	32	D5SBA60	14	D20FDC15ST	26			DF30NC15	26	K1VZL20	40	M1FH3	22	MV1001SC	58
D2FL20U	32	D6FEC4ST	26	D20FDC20L	34			DF30SC3ML	26	KC3FB40H	38	M1FJ4	22	MV1002SC	58
D2FL40	32	D6FEC10ST	26	D20FDC20LUS	34	D240SC4M	30	DF30SC4M	26	KC5FB40H	38	M1FK60	32	MV1011SC	58
D2FS4	22	D6FEC12ST	26	D20FR4ST	22	D240SC6M	30	DF40SC3L	26	KC5FB60H	38	M1FL20U	32	MV1012SC	58
D2FS6	22	D6FEC15ST	26	D20FR4R5S	22	D360SC4M	30	DF40SC4	26	KC5FB60HR	38	M1FL40U	32	MV2002SG	58
D2L20U	32	D6JBB60V	14			D360SC6M	30	DG1H3	22	KC5FB60HRT	38	M1FM3	22	MV2052SG	58
D2L40U	32	D6JBB80V	14			DE3L20UA	32	DG1H3A	22	KC5SF60HRT	38	M1FS4	22	P0R5B60HP2	54
D2S4M	24	D6SB60L	14					DG1J10A	22	KC8SF80	38	M1FS6	22	P1B52HP2	54
D2S6M	24	D6SB80	14	D20XB60	14	DE3S4M	22	DG1M3	22	KD3FB60	42	M2F60	8	P1FE90VX3	54
D2SB60	14	D6SBN20	18	D20XB80	14	DE3S6M	22	DG1M3A	22	KD3SF60	42	M2FH3	22	P1R5B40HP2	54
D2SB60A	14	D8FD60LUS	32	D20XBS6	18	DE5L60A	32	DG1N15A	22	KD3SF60E	42	M2FL20U	32	P2B60HP2F	54
D2SBA60	14	D8JBB60V	14	D25FD60V	8	DE5L60U	32	DG1S4	22	KD5SF60	42	M2FM3	22	P2FE60VX5K	54

INDEX

INDEX

Type No.	Page	Type No.	Page	Type No.	Page	Type No.	Page	Type No.	Page	Type No.	Page	Type No.	Page	Type No.	Page
P2R5B52HP2F	54	P20FH50HP2	54	P50LF10SL	50	P105LF4QNK	50	S10VB60	16			SG30SC3LM	28	ST04-14F1	46
P3B28HP2	54	P21F28HP2	54	P50LF10SLK	50	P126FP10SN	52	S10VT60	18	S60SC3LT	28	SG30SC4M	28	ST04-16F1	46
P3F60HP2	54	P22F10SN	52	P50LF10SN	50	P126FP10SNK	52	S10VT80	18	S60SC4MT	28	SG30SC6M	28	ST04-18F1	46
P3FH90VX3	54	P22FE4SBK	52	P50LF10SNK	50	P140LF4QL	50	S10VTA60	18	S60SC6MT	28	SG30TC10M	28	ST04-20F1	46
P4B40HP2	54	P23F40HP2FM	54	P54B4SN	50	P140LF4QLK	50	S10VTA80	18	S90T15V	24	SG30TC12M	28	ST04-24F1	46
P4B60HP2F	54	P23LA10SL	50	P55F6EN	52	P140LF4QN	50	S10WB60	16	SF3K60M	34	SG30TC15M	28	ST04-27F1	46
P4F60HP2	54	P24B4SB	50	P56LA4SN	50	P140LF4QNK	50	S15VB60	16	SF3L60U	34	SG40TC10M	28	ST04-30F1	46
P4F90VX3	54	P25B6EB	50	P60B4EL	50	P153FP6SN	52	S15VT60	18	SF5K60M	34	SG40TC12M	28	ST04-33F1	46
P5B52HP2	54	P25LA12SL	50	P60B4SN	50	P153FP6SNK	52	S15VT80	18	SF5L40UM	34	ST02-12G1	46	ST04-36F1	46
P5F50HP2	54	P25LF12SL	50	P60B6EL	50	P168FP7R5SN	52	S15VTA60	18	SF5L60U	34	ST02-14G1	46	ST04-39F1	46
P5F50HP2F	54	P25LF12SLK	50	P60B6EN	50	P168FP7R5SNK	52	S15VTA80	18	SF5LC40UM	36	ST02-16G1	46	ST06-18CE	46
P5F60HP2	54	P25LF12SN	50	P60B6SN	50	P175FP4SN	52	S15WB60	16	SF8K60M	34	ST02-18G1	46	ST06-27CE	46
P5FH90VX3	54	P25LF12SNK	50	P64LF6QL	50	P175FP4SNK	52	S20K60T	34	SF8K60USM	34	ST02-20G1	46	ST06-30CE	46
P6B28HP2	54	P26B10SL	50	P64LF6QLK	50	P180FP4SN	52	S20K100V	34	SF10K60M	34	ST02-24G1	46	ST06-33CE	46
P6B40HP2	54	P26B10SN	50	P64LF6QN	50	P180FP4SNK	52	S20LC20UST	36	SF10KC60M	36	ST02-27G1	46	ST06-36CE	46
P6B52HP2	54	P26F28HP2	54	P64LF6QNK	50	P180FP6SN	52	S20LC30T	36	SF10L60U	34	ST02-30G1	46	ST06-39CE	46
P6F50HP2	54	P26FE10SLK	52	P66F7R5SN	52	P180FP6SNK	52	S20LC40UT	36	SF10L60MSM	34	ST02-33G1	46	ST20-27F2	46
P6FE25VX5K	54	P30B10EL	50	P66F7R5SNK	52	P211FZ4QMKA	52	S20LC40UV	36	SF10L60MVM	34	ST02-36G1	46	ST20-30F2	46
P7F60HP2	54	P30FE4SLK	52	P70F5EN	52	P240FZ4QLA	52	S20LC60UST	36	SF10LC40UM	36	ST02-39G1	46	ST20-33F2	46
P7F90VX3	54	P30FE6SLK	52	P70F7R5EN	52	P240FZ4QNKA	52	S20LC60USV	36	SF20K60M	34	ST02-43G1	46	ST20-36F2	46
P7FH60HP2	54	P30FE7R5SLK	52	P70FP12SN	52	S1NAD80	10	S20SC9MT	28	SF20KC60M	36	ST02-47G1	46	ST20-47F2	46
P8B10SB	50	P30LA10SL	50	P70FP12SNK	52	S1NB60	12	S20VT60	18	SF20L60U	34	ST02-58G1	46	ST60-40MF	46
P8B28HP2	54	P30W60HP2V	54	P70LF4QLK	50	S1NB80	12	S20VT80	18	SF20L60MSM	34	ST02-75F1	46	ST60-48MF	46
P8B30HP2	54	P32B12SN	50	P70LF4QNK	50	S1NBB80	12	S20VTA60	18	SF20L60MVM	34	ST02-82F1	46	ST70-27F	46
P8F28HP2	54	P32F12SN	52	P72LF7R5SL	50	S1NBC60	12	S20VTA80	18	SF20LC30M	36	ST02-100F1	46	ST70-27FZ	46
P8F50HP2	54	P32FG15SL	52	P72LF7R5SLK	50	S1NBC80	12	S20WB60	16	SG5L20USM	34	ST02-120F1	46	ST70-27MF	46
P8FE10SBK	52	P32LF10SL	50	P72LF7R5SN	50	S1WB(A)60	12	S20WB80	16	SG5LC20USM	36	ST02-140F1	46	ST70-30MF	46
P9B30HP2F	54	P32LF10SLK	50	P72LF7R5SNK	50	S1WB(A)60B	12	S25VB60	16	SG5S4M	24	ST02-170F1	46	ST80-14MF	46
P9B40HP2	54	P32LF10SN	50	P80FG6EAL	52	S1WB(A)80	12	S25VB80	16	SG5S6M	24	ST02-200F1	46	UD2KB80	14
P10B28HP2	54	P32LF10SNK	50	P80FG7R5EN	52	S1ZAS4	30	S30K60T	34	SG5S9M	24	ST02-280F1	46	UD3KB80	14
P10F50HP2	54	P34F6EL	52	P80FH5ENK	52	S1ZB60	12	S30K60V	34	SG8SC4M	28	ST02-320F1	46	UD4KB80	14
P10F60HP2	54	P36F28HP2	54	P82F7R5SN	52	S1ZB80	12	S30K100V	34	SG10L20USM	34	ST02D-82	48	UD6KB80	14
P12F60HP2	54	P36FH28HP2	54	P85FG6EAL	52	S2K100	32	S30SC4MT	28	SG10LC20USM	36	ST02D-140	48	UD8KB80	14
P12FE7R5SBK	52	P38LF6QLK	50	P85W28HP2F	54	S2L20U	32	S30SC6MT	28	SG10SC3LM	28	ST02D-140F2	48	VR-61F1	44
P13F28HP2	54	P38LF6QNK	50	P86F6SN	52	S2L40U	32	S30TC15T	28	SG10SC4M	28	ST02D-170	48		
P13F50HP2	54	P40B10SL	50	P88FP10SN	52	S2L60	32	S30V60T	10	SG10SC6M	28	ST02D-170F2	48		
P14FE6SBK	52	P40B10SN	50	P88FP10SNK	52	S2V60	8	S30V80V	10	SG10SC9M	28	ST02D-200	48		
P15F50HP2	54	P40B6SL	50	P90FG5R5SL	52	S2V80	8	S30VT60	18	SG10TC15M	28	ST02DH-280	48		
P15F60HP2	54	P40F10SN	52	P94FG5R5SL	52	S2VB60	16	S30VT80	18	SG15SC4M	28	ST02DH-320	48		
P15F60HP2F	54	P40F12SN	52	P98LF6QL	50	S2WB(A)80	12	S30VT160	18	SG15SC6M	28	ST03-43F1	46		
P15FH60HP2	54	P40LF12SL	50	P98LF6QLK	50	S3K60	32	S30VTA60	18	SG20JC6M	28	ST03-47F1	46		
P15LA12SL	50	P40LF12SLK	50	P98LF6QN	50	S3L20U	32	S30VTA80	18	SG20LC20USM	36	ST03-58F1	46		
P16B6SB	50	P40LF12SN	50	P98LF6QNK	50	S3L40U	32	S30VTA160	18	SG20SC3LM	28	ST03-68F1	46		
P17F28HP2	54	P40LF12SNK	50	P100FA7R5EN	52	S3L60	32	S40HC1R5T	28	SG20SC4M	28	ST03-240F1	46		
P18LA12SL	50	P42F6EN	52	P100FH4ENK	52	S3V60	8	S40T15V	24	SG20SC6M	28	ST03D-82	48		
P19LA10SL	50	P46LF7R5SL	50	P100FP12SN	52	S3V80	8	S50VB60	16	SG20SC9M	28	ST03D-140	48		
P20B12SL	50	P46LF7R5SLK	50	P100FP12SNK	52	S3V100D	8	S50VB80	16	SG20TC10M	28	ST03D-170	48		
P20B12SN	50	P46LF7R5SN	50	P105LF4QL	50	S3WB60	16	S60HC1R5T	28	SG20TC12M	28	ST03D-200	48		
P20F50HP2	54	P46LF7R5SNK	50	P105LF4QLK	50	S4VB60	16	S60HC3T	28	SG20TC15M	28	ST03DH-240	48		
P20FE12SLK	52	P50F10SN	52	P105LF4QN	50	S5VB60	16	S60JC10V	28	SG30JC6M	28	ST04-12F1	46		

INDEX











GENERAL RECTIFYING DIODES

General Rectifying Diodes are defined as high-voltage and PN junction type devices.



These devices utilize our original glass passivation which is physically stable with a superior structure for resistance against heat and humidity.

Variations are available for breakdown voltage up to 800V and output current from 1 to 30A.

Single

Surface Mount		JEDEC Code JEITA Code House Name	Fig.	IF(AV) [A]	VRRM [V]			Remarks
Package					400	600	800	
 3.9 × 1.8 × 1.4(mm)	DO-219AA similar - M1F	B2	1		M1F60 M1FE60	M1F80	① → ← ②	
			2	M1FE40				
 5.0 × 2.5 × 2.0(mm)	DO-214AC - 1F	B3-1	1		D1F60 D1FE60 LN1F60		① → ← ②	
			1.1					
			1.2		D1F60A			
 4.7 × 2.4 × 0.98(mm)	- SC-110B CE	B5-1	3		D3CE60V		① → ← ②	
			3.5		 D3CE60VE			
 5.1 × 3.75 × 2.0(mm)	DO-214AA similar - M2F	B6	1.2		M2F60		① → ← ②	
			3	M3FE40	M3F60 M3FE60			
			1.4		D2F60			
 7.6 × 4.0 × 2.8(mm)	- - 2F	B9-1	3		D3F60 D3FE60		① → ← ②	
			4		D4F60			
			5		D5FE60			
 9.5 × 6.6 × 2.65(mm)	- SC-63 E-pack	G1-5	5	DE5VE40			① ④ ← ② ③ N.C.	
 6.5 × 4.5 × 1.1(mm)	TO-277A similar - FY	G4	10		D10FY60VE		① ← ② ③	
 9.6 × 6.6 × 2.3(mm)	TO-252AA similar - FR	G5	10		D10FR60V		① ← ② ③ N.C.	
			15		D15FR60V			
 13.2 × 10.2 × 4.7(mm)	- SC-83 similar STO-220	H1-2	25		DF25V60		① ② ④ ← ③	
 13.2 × 10.2 × 4.6(mm)	- SC-83 similar FD	H2-1	25		D25FD60V		① ← ② ③ N.C.	

 : New product

Axial		JEDEC Code JEITA Code House Name	Fig.	IF(AV) [A]	VRRM [V]			Remarks
Package					400	600	800	
 3.0 × φ 2.6(mm)	- AX057	A1	1		D1N60	D1N80	① → ← ②	
 7.0 × φ 4.4(mm)	- AX10	A5-1	1.7		S2V60	S2V80		
 7.0 × φ 4.4(mm)	- AX14	A7	3			S3V100D		
			3.5		S3V60	S3V80		

Single

Surface Mount		JEDEC Code JEITA Code House Name	Fig.	Type No.	Absolute Maximum Ratings				Electrical Characteristics				Based on AEC-Q101	Automotive	
Package					IF (AV) [A]	Conditions Ta [°C]	IFSM [A]	VRRM [V]	Tj [°C]	Vf (max) [V]	Conditions IF [A]	Ir (max) Vr=VRRM [μA]			VESD (typ) [kV]
DO-219AA similar - M1F	B2			M1F60	1	25	25	600	150	1.10	1	10	-	-	○
				M1FE60	1	129 *1	30	600	150	1.10	1	10	25	○	○
				M1F80	1	25	25	800	150	1.10	1	10	-	-	○
				M1FE40	2	103 *2	25	400	150	1.10	1	10	-	-	○
DO-214AC - 1F	B3-1			D1F60	1	25	25	600	150	1.10	1	10	-	-	○
				D1FE60	1	126 *1	30	600	150	1.10	1	10	25	○	○
				LN1F60 *3	1.1	25	25	600	150	1.05	0.8	10	-	-	-
- SC-110B CE	B5-1			D1F60A	1.2	25	45	600	150	0.97	1.2	10	-	-	○
				D3CE60V	3	101 *1	50	600	150	1.10	3	10	-	-	○
DO-214AA similar - M2F	B6			 D3CE60VE	3.5	93 *1	60	600	-55 to 150	1.10	3.5	10	25	○	■
				M2F60	1.2	51	50	600	150	0.97	1.2	10	-	-	○
				M3FE40	3	76 *1	75	400	150	1.10	3	10	30	-	○
				M3F60	3	100 *1	90	600	150	1.05	3	10	-	-	○
- - 2F	B9-1			M3FE60	3	76 *1	90	600	150	1.05	3	10	25	○	○
				D2F60	1.4	25	60	600	150	1.05	1.4	10	-	-	○
				D3F60	3	80 *1	150	600	150	1.05	3	10	-	-	○
				D3FE60	3	105 *1	150	600	150	1.05	3	10	25	○	○
- SC-63 E-pack	G1-5			D4F60	4	68 *1	200	600	150	0.95	4	10	-	-	○
				D5FE60	5	82 *1	300	600	150	0.95	5	10	25	○	○
				DE5VE40	5	130 *2	80	400	150	1.00	5	10	30	-	■
TO-277A similar - FY	G4		D10FY60VE	10	120 *1	220	600	-55 to 150	1.10	10	10	25	○	○	
TO-252AA similar - FR	G5		D10FR60V	10	130 *2	200	600	-55 to 150	1.05	10	10	-	-	■	
- SC-83 similar STO-220	H1-2			D15FR60V	15	125 *2	300	600	-55 to 150	1.05	15	10	-	-	■
				DF25V60	25	136 *2	400	600	150	1.10	25	10	-	-	-
- SC-83 similar FD	H2-1		D25FD60V	25	113 *2	450	600	150	1.10	25	10	-	○	○	



 : New product *1 : Tl *2 : Tc *3 : tr(max)=3.5μs ■ : Please contact us.

Axial		JEDEC Code JEITA Code House Name	Fig.	Type No.	Absolute Maximum Ratings				Electrical Characteristics				Based on AEC-Q101	Automotive	
Package					IF (AV) [A]	Conditions Ta [°C]	IFSM [A]	VRRM [V]	Tj [°C]	Vf (max) [V]	Conditions IF [A]	Ir (max) Vr=VRRM [μA]			VESD (typ) [kV]
-	A1			D1N60	1	25	30	600	150	1.05	1	10	-	-	-
				D1N80	1	25	30	800	150	1.05	1	10	-	-	-
-	A5-1			S2V60	1.7	40	60	600	150	1.05	1.7	10	-	-	-
				S2V80	1.7	40	60	800	150	1.05	1.7	10	-	-	-
-	A7			S3V100D	3	130 *1	150	800	150	1.05	3	10 *2	-	-	-
				S3V60	3.5	40	120	600	150	1.05	2.6	10	-	-	-
				S3V80	3.5	40	120	800	150	1.05	2.6	10	-	-	-

*1 : Tl *2 : Vr=1000V



GENERAL RECTIFYING DIODES

Single

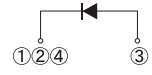
Two Terminal Type							
Package	JEDEC Code JEITA Code House Name	Fig.	IF(AV) [A]	VRRM [V]			Remarks
				400	600	800	
 41.0 × 16.0 × 5.0(mm)	TO-247AD - MTO-3PT	K2	30		S30V60T		

Three Terminal Type							
Package	JEDEC Code JEITA Code House Name	Fig.	IF(AV) [A]	VRRM [V]			Remarks
				400	600	800	
 41.0 × 16.0 × 5.0(mm)	TO-247AD - MTO-3PV	K6	30		S30V80V		

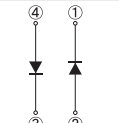
Array

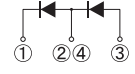
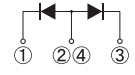
Surface Mount							
Package	JEDEC Code JEITA Code House Name	Fig.	IF(AV) [A]	VRRM [V]			Remarks
				400	600	800	
 10.0 × 6.8 × 2.6(mm)	- 1NA	C6-2	3		S1NAD80		
 13.2 × 10.2 × 4.7(mm)	- SC-83 similar STO-220	H1-5	5		DF5VD60		
			15		DF15VD60		
		H1-7	16		DF16VC60R		

Diode Module

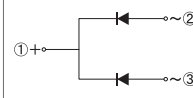
Diode Module							
Package	JEDEC Code JEITA Code House Name	Fig.	IF(AV) [A]	VRRM [V]			Remarks
				400	600	800	
 22.3 × 22.3 × 25.0(mm)	- D30VC	E2	30		D30VC60		

Single

Two Terminal Type		Type No.	Absolute Maximum Ratings					Electrical Characteristics				Based on AEC-Q101	Automotive
JEDEC Code JEITA Code House Name	Fig.		IF (AV) [A]	Conditions Tc [°C]	IFSM [A]	VRRM [V]	Tj [°C]	Vf (max) [V]	Conditions If [A]	Ir (max) Vr=VRRM [μA]	VESD (typ) [kV]		
TO-247AD - MTO-3PT	K2	S30V60T	30	119	360	600	150	1.1	30	10	-	-	-

Three Terminal Type		Type No.	Absolute Maximum Ratings					Electrical Characteristics				Based on AEC-Q101	Automotive
JEDEC Code JEITA Code House Name	Fig.		IF (AV) [A]	Conditions Tc [°C]	IFSM [A]	VRRM [V]	Tj [°C]	Vf (max) [V]	Conditions If [A]	Ir (max) Vr=VRRM [μA]	VESD (typ) [kV]		
TO-247AD - MTO-3PV	K6	S30V80V	30	131	450	800	150	1.1	30	10	-	-	○

Array

Surface Mount		Type No.	Absolute Maximum Ratings					Electrical Characteristics				Based on AEC-Q101	Automotive
JEDEC Code JEITA Code House Name	Fig.		IF (AV) [A]	Conditions Tc [°C]	IFSM [A]	VRRM [V]	Tj [°C]	Vf (max) [V]	Conditions If [A]	Ir (max) Vr=VRRM [μA]	VESD (typ) [kV]		
- 1NA	C6-2	S1NAD80	3	102 *	110	800	150	1.05	0.75	10	-	-	-
- SC-83 similar STO-220	H1-5	DF5VD60	5	140	140	600	150	1.05	2.50	10	-	-	-
		DF15VD60	15	127	190	600	150	1.05	7.50	10	-	-	-
	H1-7	DF16VC60R	16	124	190	600	150	1.05	8.00	10	-	-	-

* : Tl

Diode Module







Diode Module		Type No.	Absolute Maximum Ratings					Electrical Characteristics				Based on AEC-Q101	Automotive
JEDEC Code JEITA Code House Name	Fig.		IF (AV) [A]	Conditions Tc [°C]	IFSM [A]	VRRM [V]	Tj [°C]	Vf (max) [V]	Conditions If [A]	Ir (max) Vr=VRRM [μA]	VESD (typ) [kV]		
- D30VC	E2	D30VC60	30	124	300	600	150	1.05	15	10	-	-	-



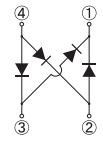

BRIDGE DIODES

Bridge Diodes are suitable for the rectification of commercial voltage.

Variations are available for various packaging as well as high voltage (Max 1600V), high IFSM, low VF, and low noise.

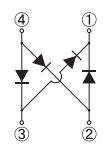
Small Bridge Diodes

Surface Mount							
Package	JEDEC Code JEITA Code House Name	Fig.	IF(AV) [A]	VRRM [V]			Remarks
				600	800	1000	
 7.0 × 4.7 × 2.6(mm)	TO-269AA 1Z	C2-1	0.8	S1ZB60	S1ZB80		
 6.2 × 5.15 × 1.45(mm)	SOPA-4	C1	1		D1UBA80		
 10.0 × 6.8 × 2.6(mm)	1N	C4	1	S1NB60	S1NB80		
 10.0 × 6.8 × 2.6(mm)	1NA	C6-1	1		S1NBB80		
 10.0 × 6.8 × 2.6(mm)	1NA	C6-1	1.5	S1NBC60	S1NBC80		
 10.6 × 10.2 × 3.1(mm)	1W	C8	1	S1WB(A)60 S1WB(A)60B	S1WB(A)80		
			2		S2WB(A)80		

THD (Through Hole Device)							
Package	JEDEC Code JEITA Code House Name	Fig.	IF(AV) [A]	VRRM [V]			Remarks
				600	800	1000	
 3.8 × 4.7 × 2.5(mm)	1Z	C3	0.8	S1ZB60	S1ZB80		
 6.5 × 6.8 × 2.5(mm)	1N	C5	1	S1NB60	S1NB80		
 6.5 × 6.8 × 2.5(mm)	1NA	C7	1		S1NBB80		
 6.5 × 6.8 × 2.5(mm)	1NA	C7	1.5	S1NBC60	S1NBC80		
 6.2 × 10.2 × 3.0(mm)	1W	C9	1	S1WB(A)60 S1WB(A)60B	S1WB(A)80		
			2		S2WB(A)80		

Small Bridge Diodes

Surface Mount													
Package		Type No.	Spec. Code	Absolute Maximum Ratings					Electrical Characteristics			UL	Automotive
JEDEC Code JEITA Code House Name	Fig.			IF (AV) [A]	Conditions Ta [°C]	IFSM [A]	VRRM [V]	Tj [°C]	Vf (max) [V]	Conditions IF [A]	IR (max) Vr=VRRM [μA]		
TO-269AA 1Z	C2-1	S1ZB60	-7072	0.8	25	30	600	150	1.05	0.4	10	--	--
		S1ZB80	-7072	0.8	25	30	800	150	1.05	0.4	10	--	--
SOPA-4	C1	D1UBA80	-7062	1	25	30	800	150	0.95	0.4	10	--	--
1N	C4	S1NB60	-7062	1	25	30	600	150	1.05	0.5	10	--	--
		S1NB80	-7062	1	25	30	800	150	1.05	0.5	10	--	--
1NA	C6-1	S1NBB80	-7062	1	26	50	800	150	1.05	0.5	10	--	--
		S1NBC60	-7062	1.5	105 *	60	600	150	1.05	0.75	10	--	--
		S1NBC80	-7062	1.5	105 *	60	800	150	1.05	0.75	10	--	--
1W	C8	S1WB(A)60	-7062	1	25	30	600	150	1.00	0.5	10	--	--
		S1WB(A)60B	-7062	1	25	50	600	150	1.00	0.5	10	--	--
		S1WB(A)80	-7062	1	25	30	800	150	1.00	0.5	10	--	--
		S2WB(A)80	-7062	2	112 *	50	800	-40 to 150	1.05	1	10	--	--

* : Tj









THD (Through Hole Device)													
Package		Type No.	Spec. Code	Absolute Maximum Ratings					Electrical Characteristics			UL	Automotive
JEDEC Code JEITA Code House Name	Fig.			IF (AV) [A]	Conditions Ta [°C]	IFSM [A]	VRRM [V]	Tj [°C]	Vf (max) [V]	Conditions IF [A]	IR (max) Vr=VRRM [μA]		
1Z	C3	S1ZB60	-7101	0.8	25	30	600	150	1.05	0.4	10	--	--
		S1ZB80	-7101	0.8	25	30	800	150	1.05	0.4	10	--	--
1N	C5	S1NB60	-7101	1	25	30	600	150	1.05	0.5	10	--	--
		S1NB80	-7101	1	25	30	800	150	1.05	0.5	10	--	--
1NA	C7	S1NBB80	-7101	1	26	50	800	150	1.05	0.5	10	--	--
		S1NBC60	-7101	1.5	105 *	60	600	150	1.05	0.75	10	--	--
		S1NBC80	-7101	1.5	105 *	60	800	150	1.05	0.75	10	--	--
1W	C9	S1WB(A)60	-7101	1	25	30	600	150	1.00	0.5	10	--	--
		S1WB(A)60B	-7101	1	25	50	600	150	1.00	0.5	10	--	--
		S1WB(A)80	-7101	1	25	30	800	150	1.00	0.5	10	--	--
		S2WB(A)80	-7101	2	112 *	50	800	-40 to 150	1.05	1	10	--	--

* : Tj

BRIDGE DIODES

BRIDGE DIODES

SIP (Single In-line Package) Bridge Diodes

THD (Through Hole Device)							
Package	JEDEC Code JEITA Code House Name	Fig.	IF(AV) [A]	VRRM [V]			Remarks
				600	800	1000	
 24.0 × 13.8 × 3.1(mm)	-	D3K	D1	2	UD2KB80		
				3	UD3KB80		
				4	UD4KB80		
				6	UD6KBA80		
				8	UD8KBA80		
 24.5 × 20.0 × 3.5(mm)	-	2S	D2	1.5	D2SBA60 D2SB60		
				2	D2SB60A		
 25.2 × 25.0 × 4.2(mm)	-	JB	D5	6	D6JBB60V	D6JBB80V	
				8	D8JBB60V	D8JBB80V	
				10	D10JBB60V	D10JBB80V	
 32.5 × 25.0 × 4.6(mm)	-	3S	D3	4	D3SBA60 D3SB60 D4SB60L	D3SB80 D4SB80	
				10	D10XB60 D10XB60H	D10XB80	
 29.4 × 29.0 × 4.6(mm)	-	JA	D6	15	D15JAB60V	D15JAB80V	
				25	D25JAB60V	D25JAB80V	
 37.5 × 30.0 × 4.6(mm)	-	5S	D4	6	D5SBA60 D5SB60 D6SB60L	D5SB80 D6SB80	
				15	D15XB60 D15XB60H	D15XB80	D15XB100
				20	D20XB60	D20XB80	
				25	D25XB60	D25XB80	D25XB100
				35		 D35XB80	
 47.0 × 45.7 × 7.5(mm)	-	TSB(4pin)	D7	50		D50XB80	
				50		D50JCB80V	

 : New product

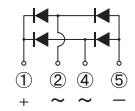
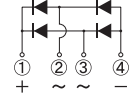





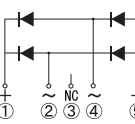





































DIP (Dual In-line Package) Bridge Diode

Package	JEDEC Code JEITA Code House Name	Fig.	IF(AV) [A]	VRRM [V]			Remarks
				600	800	1000	
 47.0 × 45.7 × 7.5(mm)	-	JH	D10-1	70	D70JHB80V		



SIP (Single In-line Package) Bridge Diodes

THD (Through Hole Device)												
Package		Type No.	Absolute Maximum Ratings				Electrical Characteristics			UL	Automotive	
JEDEC Code JEITA Code House Name	Fig.		IF (AV) [A]	Conditions Tc [°C]	IFSM [A]	VRRM [V]	Tj [°C]	Vf (max) [V]	Conditions IF [A]			Ir (max) Vr=VRRM [μA]
-	D3K	UD2KB80	2	143	62	800	150	1.05	1	10		-
		UD3KB80	3	140	90	800	150	1.05	1.5	10		-
		UD4KB80	4	138	135	800	150	1.00	2	10		-
		UD6KBA80	6	131	135	800	150	1.05	3	10		-
		UD8KBA80	8	126	165	800	150	1.05	4	10		-
-	2S	D2SBA60	1.5	25 *1	60	600	150	1.05	0.75	10	-	-
		D2SB60	1.5	25 *1	80	600	150	1.05	0.75	10	-	-
		D2SB60A	2	115 *2	120	600	150	0.95	1	10	-	-
-	JB	D6JBB60V	6	131	100	600	150	1.05	3	10		-
		D6JBB80V	6	131	100	800	150	1.05	3	10		-
		D8JBB60V	8	130	130	600	150	1.05	4	10		-
		D8JBB80V	8	130	130	800	150	1.05	4	10		-
		D10JBB60V	10	129	150	600	150	1.05	5	10		-
-	3S	D3SBA60	4	108	80	600	150	1.05	2	10		-
		D3SB60	4	108	120	600	150	1.05	2	10		-
		D4SB60L	4	111	150	600	150	0.95	2	10		-
		D3SB80	4	108	120	800	150	1.05	2	10		-
		D4SB80	4	108	150	800	150	0.95	2	10		-
-	D6	D10XB60	10	100	120	600	150	1.10	5	10		-
		D10XB60H	10	112	170	600	150	1.05	5	10		-
		D10XB80	10	100	120	800	150	1.10	5	10		-
		D15JAB60V	15	110	200	600	150	1.05	7.5	10		-
		D15JAB80V	15	110	200	800	150	1.05	7.5	10		-
		D25JAB60V	25	107	350	600	150	1.05	12.5	10		-
		D25JAB80V	25	107	350	800	150	1.05	12.5	10		-
		D5SBA60	6	111	120	600	150	1.05	3	10		-
		D5SB60	6	110	170	600	150	1.05	3	10		-
		D6SB60L	6	112	170	600	150	1.05	3	10		-
-	D4	D5SB80	6	110	170	800	150	1.05	3	10		-
		D6SB80	6	110	170	800	150	1.05	3	10		-
		D15XB60	15	100	200	600	150	1.10	7.5	10		-
		D15XB60H	15	107	240	600	150	1.05	7.5	10		-
		D15XB80	15	100	200	800	150	1.10	7.5	10		-
		D15XB100	15	110	200	1000	150	1.10	7.5	10		-
		D20XB60	20	87	240	600	150	1.10	10	10		-
		D20XB80	20	87	240	800	150	1.10	10	10		-
		D25XB60	25	98	350	600	150	1.05	12.5	10		
		D25XB80	25	98	350	800	150	1.05	12.5	10		
-	D7	D25XB100	25	106	350	1000	150	1.05	12.5	10		-
		 D35XB80	35	93	550	800	-55 to 150	1.05	17.5	10		-
-	TSB(4pin)	D50XB80	50	95	600	800	150	1.05	25	10		-
-	JC(4pin)	D50JCB80V	50	94	600	800	150	1.05	25	10		







 : New product *1 : Ta *2 : Tl  : Please contact us.  : UL recognized (UL File No. E142422)

DIP (Dual In-line Package) Bridge Diode

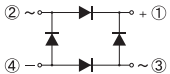



THD (Through Hole Device)												
Package		Type No.	Absolute Maximum Ratings				Electrical Characteristics			UL	Automotive	
JEDEC Code JEITA Code House Name	Fig.		IF (AV) [A]	Conditions Tc [°C]	IFSM [A]	VRRM [V]	Tj [°C]	Vf (max) [V]	Conditions IF [A]			Ir (max) Vr=VRRM [μA]
-	JH	D70JHB80V	70	99	500	800	-55 to 150	1.1	35	10	-	-

BRIDGE DIODES



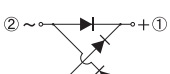

SQIP (Square In-line Package) Bridge Diodes

Package	JEDEC Code JEITA Code House Name	Fig.	IF(AV) [A]	VRRM [V]			Remarks
				600	800	1000	
 13.0 × 13.0 × 27.5(mm)	— S2VB	E3	2	S2VB60			
 17.0 × 17.0 × 32.5(mm)	— S4VB	E4	4	S4VB60			
 25.0 × 25.0 × 32.5(mm)	— S5VB	E5	6	S5VB60			
 22.0 × 22.0 × 32.5(mm)	— S10VB	E6	10	S10VB60			
 26.5 × 26.5 × 25.0(mm)	— S15VB	E7	15	S15VB60			
 32.0 × 32.0 × 25.0(mm)	— S25VB	E8	25	S25VB60	S25VB80		
 36.0 × 36.0 × 24.0(mm)	— S50VB	E9	50	S50VB60	S50VB80		

Input/Output In-line Terminal Type

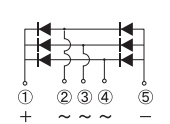
Package	JEDEC Code JEITA Code House Name	Fig.	IF(AV) [A]	VRRM [V]			Remarks
				600	800	1000	
 17.0 × 17.0 × 31.0(mm)	— S3WB	E10	2.3	S3WB60			
 22.5 × 22.5 × 32.5(mm)	— S10WB	E11	10	S10WB60			
 26.5 × 26.5 × 32.5(mm)	— S15WB	E12	15	S15WB60			
 32.5 × 32.5 × 32.5(mm)	— S20WB	E13	20	S20WB60	S20WB80		

3 Phase Bridge Diodes

Package	JEDEC Code JEITA Code House Name	Fig.	IF(AV) [A]	VRRM [V]			Remarks
				800	1200	1600	
 47.0 × 45.7 × 7.5(mm)	— TSB(5pin)	D8	30	D30XT80			
			45	D45XT80		D45XT160	
 47.0 × 45.7 × 7.5(mm)	— JC(5pin)		30		D30JCT120V		
			45		D45JCT120V	D45JCT160V	
 47.0 × 45.7 × 7.5(mm)	— JF	D9	75	D75JFT80V			
 47.0 × 45.7 × 7.5(mm)	— JH	D10-2	100	D100JHT80V	D100JHT120V	 D100JHT160V	

 : New product

SQIP (Square In-line Package) Bridge Diodes

Package		Type No.	Absolute Maximum Ratings				Electrical Characteristics			UL	Automotive	
JEDEC Code JEITA Code House Name	Fig.		IF(AV) [A]	Conditions Tc [°C]	IFSM [A]	VRRM [V]	Tj [°C]	Vf (max) [V]	Conditions IF [A]			Ir (max) Vr=VRRM [μA]
— S2VB	E3	S2VB60	2 *1	40	40	600	150	1.05	1	10	—	—
— S4VB	E4	S4VB60	4	40	80	600	150	1.05	2	10	—	—
— S5VB	E5	S5VB60	6	40	200	600	150	1.05	3	10	—	—
— S10VB	E6	S10VB60	10	40	200	600	150	1.05	5	10	—	—
— S15VB	E7	S15VB60	15	83 *2	200	600	150	1.05	7.5	10	—	—
— S25VB	E8	S25VB60	25	85 *2	400	600	150	1.05	12.5	10	—	—
— S25VB80		S25VB80	25	85 *2	400	800	150	1.05	12.5	10	—	—
— S50VB	E9	S50VB60	50	95 *2	500	600	150	1.05	25	10	—	—
— S50VB80		S50VB80	50	95 *2	500	800	150	1.05	25	10		—











*1 : Without heatsink *2 : Tc  : UL recognized (UL File No. E142422)



Input/Output In-line Terminal Type

Package		Type No.	Absolute Maximum Ratings				Electrical Characteristics			UL	Automotive	
JEDEC Code JEITA Code House Name	Fig.		IF(AV) [A]	Conditions Tc [°C]	IFSM [A]	VRRM [V]	Tj [°C]	Vf (max) [V]	Conditions IF [A]			Ir (max) Vr=VRRM [μA]
— S3WB	E10	S3WB60	2.3	40 *	120	600	150	1.05	2	10	—	—
— S10WB	E11	S10WB60	10	74	170	600	150	1.05	5	10	—	—
— S15WB	E12	S15WB60	15	77	200	600	150	1.05	7.5	10	—	—
— S20WB	E13	S20WB60	20	76	500	600	150	1.05	10	10	—	—
— S20WB80		S20WB80	20	76	500	800	150	1.05	10	10		—

* : Ta  : UL recognized (UL File No. E142422)

3 Phase Bridge Diodes





Package		Type No.	Absolute Maximum Ratings				Electrical Characteristics			UL	Automotive	
JEDEC Code JEITA Code House Name	Fig.		IF(AV) [A]	Conditions Tc [°C]	IFSM [A]	VRRM [V]	Tj [°C]	Vf (max) [V]	Conditions IF [A]			Ir (max) Vr=VRRM [μA]
— TSB(5pin)	D8	D30XT80	30	117	300	800	150	1.05	10	10		—
		D45XT80	45	101	400	800	150	1.05	15	10		—
		D45XT160	45	97	330	1600	150	1.05	15	100		—
— JC(5pin)		D30JCT120V	30	116	300	1200	150	1.05	10	10		—
		D45JCT120V	45	99	450	1200	150	1.05	15	10		—
		D45JCT160V	45	97	450	1600	150	1.05	15	10		—
— JF	D9	D75JFT80V	75	109	400	800	150	1.05	25	10	—	—
— JH	D10-2	D100JHT80V	100	99	500	800	-55 to 150	1.10	35	10		—
		D100JHT120V	100	92	450	1200	-55 to 150	1.17	35	10		—
		 D100JHT160V	100	92	540	1600	-55 to 150	1.15	35	10		—

 : New product  : UL recognized (UL File No. E142422)

BRIDGE DIODES

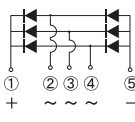

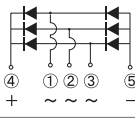
Series	Feature
S	Evenly balanced VF and Ir
N	Low VF, High Voltage
K	Low VF

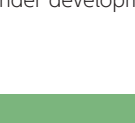
3 Phase Bridge Diodes

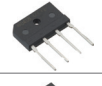
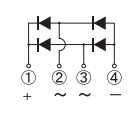

Package	JEDEC Code JEITA Code House Name	Fig.	IF(AV) [A]	VRRM [V]			Remarks	
				600	800	1600		
 36.0 × 36.0 × 24.0(mm)	-	SVT	E15	10	S10VT60	S10VT80		
				15	S15VT60	S15VT80		
				20	S20VT60	S20VT80		
				30	S30VT60	S30VT80		S30VT160
 36.0 × 36.0 × 23.0(mm)	-	SVTA	E14	10	S10VTA60	S10VTA80		
				15	S15VTA60	S15VTA80		
				20	S20VTA60	S20VTA80		
				30	S30VTA60	S30VTA80		S30VTA160
 89.0 × 50.0 × 16.6(mm)	-	-	MG038	F7	150	MG038B150080A	★MG038D150160A	
					200	MG038A200080A	★MG038C200160A	

■ : New product ★ : Under development

High Speed Bridge Diodes (SBD)

THD (Through Hole Device)							
Package	JEDEC Code JEITA Code House Name	Fig.	IF(AV) [A]	VRRM [V]			Remarks
				40	60	200	
 32.5 × 25.0 × 4.6(mm)	-	D3	4	D4SBS4	D4SBS6	D4SBN20	
			10	D10SBS4			
			15		D15XBS6		
 37.5 × 30.0 × 4.6(mm)	-	D4	6			D6SBN20	
			15			D15XBN20	
			20		D20XBS6		
			30			D30XBN20	

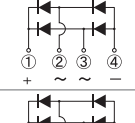
High Speed Bridge Diodes (FRD)

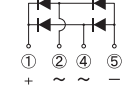
THD (Through Hole Device)							
Package	JEDEC Code JEITA Code House Name	Fig.	IF(AV) [A]	VRRM [V]			Remarks
				200	400	1000	
 32.5 × 25.0 × 4.6(mm)	-	D3	4	D4SBL20U			
 47.0 × 45.7 × 7.5(mm)	-	JC(4pin)	30			D30JCB100K	

3 Phase Bridge Diodes

Package JEDEC Code JEITA Code House Name	Fig.	Type No.	Absolute Maximum Ratings					Electrical Characteristics			UL	Automotive
			IF (AV) [A]	Conditions Tc [°C]	IFSM [A]	VRRM [V]	Tj [°C]	Vf (max) [V]	Conditions IF [A]	Ir (max) Vr=VRRM [μA]		
-	SVT	S10VT60	10	137	170	600	150	1.05	3.5	10	-	-
		S10VT80	10	137	150	800	150	1.05	3.5	10	-	-
		S15VT60	15	132	200	600	150	1.05	5	10	-	-
		S15VT80	15	132	200	800	150	1.05	5	10	-	-
		S20VT60	20	128	300	600	150	1.05	7	10	-	-
		S20VT80	20	128	300	800	150	1.05	7	10	-	-
		S30VT60	30	121	400	600	150	1.05	10	10	-	-
		S30VT80	30	121	400	800	150	1.05	10	10	UL	-
-	SVTA	S10VTA60	10	137	170	600	150	1.05	3.5	10	-	-
		S10VTA80	10	137	150	800	150	1.05	3.5	10	-	-
		S15VTA60	15	132	200	600	150	1.05	5	10	-	-
		S15VTA80	15	132	200	800	150	1.05	5	10	-	-
		S20VTA60	20	128	300	600	150	1.05	7	10	-	-
		S20VTA80	20	128	300	800	150	1.05	7	10	-	-
		S30VTA60	30	121	400	600	150	1.05	10	10	-	-
		S30VTA80	30	121	400	800	150	1.05	10	10	-	-
-	MG038	MG038B150080A	150	125	2350	800	150	1.05	67	10	UL	-
		★MG038D150160A	150	125	2350	1600	150	1.05	50	10	to be certified	-
		MG038A200080A	200	125	2750	800	150	1.05	67	10	UL	-
		★MG038C200160A	200	125	2750	1600	150	1.05	50	10	to be certified	-

■ : New product ★ : Under development UL : UL recognized (UL File No. E142422)

High Speed Bridge Diodes (SBD)

THD (Through Hole Device)													
Package JEDEC Code JEITA Code House Name	Fig.	Type No.	Absolute Maximum Ratings					Electrical Characteristics			UL	Automotive	Remarks
			IF (AV) [A]	Conditions Tc [°C]	IFSM [A]	VRRM [V]	Tj [°C]	Vf (max) [V]	Conditions IF [A]	Ir (max) Vr=VRRM [μA]			
-	3S	D4SBS4	4	116	60	40	150	0.55	2	2mA	-	-	S series
		D4SBS6	4	114	60	60	150	0.62	2	2mA	-	-	S series
		D4SBN20	4	103	60	200	150	0.90	2	1.5	-	-	N series
		D10SBS4	10	67	100	40	150	0.55	5	3.5mA	-	-	S series
		D15XBS6	15	59	150	60	150	0.63	7.5	6.0mA	-	-	S series
-	5S	D6SBN20	6	110	120	200	150	0.90	3	2	-	-	N series
		D15XBN20	15	106	200	200	150	0.90	7.5	5	-	-	N series
		D20XBS6	20	100	200	60	150	0.63	10	8.0mA	-	-	S series
		D30XBN20	30	91	350	200	150	0.90	15	10	-	-	N series

High Speed Bridge Diodes (FRD)

THD (Through Hole Device)													
Package JEDEC Code JEITA Code House Name	Fig.	Type No.	Absolute Maximum Ratings					Electrical Characteristics			UL	Automotive	Remarks
			IF (AV) [A]	Conditions Tc [°C]	IFSM [A]	VRRM [V]	Tj [°C]	Vf (max) [V]	Conditions IF [A]	Ir (max) Vr=VRRM [μA]			
-	3S	D4SBL20U	4	108	80	200	150	0.98	2	10	-	-	
-	JC(4pin)	D30JCB100K	30	90	450	1000	150	1.90	15	10	UL	○	K series

UL : UL recognized (UL File No. E142422)

BRIDGE DIODES



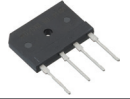
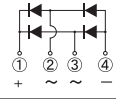

Low Vf Bridge Diodes

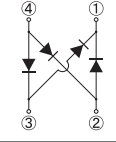
THD (Through Hole Device)							
Package	JEDEC Code JEITA Code House Name	Fig.	IF(AV) [A]	VRRM [V]			Remarks
				600	800	1000	
 37.5 × 30.0 × 4.6(mm)	— — 5S	D4	15	LL15XB60			
			25	LL25XB60			

Low Noise Bridge Diodes

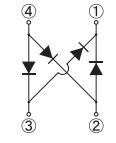
Surface Mount							
Package	JEDEC Code JEITA Code House Name	Fig.	IF(AV) [A]	VRRM [V]			Remarks
				600	800	1000	
 10.6 × 10.2 × 3.1(mm)	— — 1W	C8	1.1	LN1WBA60			

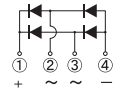
THD (Through Hole Device)

Package	JEDEC Code JEITA Code House Name	Fig.	IF(AV) [A]	VRRM [V]			Remarks
				600	800	1000	
 6.2 × 10.2 × 3.0(mm)	— — 1W	C9	1.1	LN1WBA60			
 32.5 × 25.0 × 4.6(mm)	— — 3S	D3	4	LN4SB60			
 37.5 × 30.0 × 4.6(mm)	— — 5S	D4	6	LN6SB60			
			15	LN15XB60 LN15XB60H			
			25	LN25XB60			

Low Vf Bridge Diodes

THD (Through Hole Device)													
Package		Type No.	Absolute Maximum Ratings				Electrical Characteristics					UL	Automotive
JEDEC Code JEITA Code House Name	Fig.		IF (AV) [A]	Conditions Tc [°C]	IFSM [A]	VRRM [V]	Tj [°C]	Vf (max) [V]	Conditions IF [A]	Ir (max) Vr=VRRM [μA]	trr (max) [μs]		
—	D4	LL15XB60	15	124	200	600	150	0.90	7.5	10	3	UL	—
5S		LL25XB60	25	113	300	600	150	0.92	12.5	10	3	UL	■

■ : Please contact us. UL : UL recognized (UL File No. E142422)





Low Noise Bridge Diodes

Surface Mount:THD (Through Hole Device)														
Package		Type No.	Absolute Maximum Ratings				Electrical Characteristics					UL	Automotive	Remarks
JEDEC Code JEITA Code House Name	Fig.		IF (AV) [A]	Conditions Tc [°C]	IFSM [A]	VRRM [V]	Tj [°C]	Vf (max) [V]	Conditions IF [A]	Ir (max) Vr=VRRM [μA]	trr (max) [μs]			
—	C8(SMD) C9(DIP)	LN1WBA60	1.1	25 *	50	600	150	1.00	0.55	10	5	—	—	SMD-7072 DIP-7101
1W														
—	D3	LN4SB60	4	111	150	600	150	0.95	2	10	5	UL	—	
—	D4	LN6SB60 LN15XB60 LN15XB60H LN25XB60	6	111	170	600	150	1.05	3	10	5	UL	—	
—			15	100	200	600	150	1.10	7.5	10	5	—	—	
—			15	106	290	600	150	1.05	7.5	10	5	—	—	
5S			25	85	350	600	150	1.05	12.5	10	5	—	—	



* : Ta UL : UL recognized (UL File No. E142422)

SCHOTTKY BARRIER DIODES



Single

Axial						
Package	JEDEC Code JEITA Code House Name	Fig.	IF(AV) [A]	VRRM[V]		Remarks
				40	60	
 3.0 x φ 2.6(mm)	— — AX057	A1	1	D1NS4	D1NS6	
 5.0 x φ 4.0(mm)	— — AX078	A4-1	2	D2S4M	D2S6M	
 7.0 x φ 4.4(mm)	— — AX14	A7	3	D3S4M	D3S6M	

Two Terminal Type

Package	JEDEC Code JEITA Code House Name	Fig.	IF(AV) [A]	VRRM[V]				Remarks
				40	60	90	150	
 28.5 x 10.0 x 4.5(mm)	— SC-91 FTO-220G	J4	5	SG5S4M	SG5S6M	SG5S9M		

Three Terminal Type

Package	JEDEC Code JEITA Code House Name	Fig.	IF(AV) [A]	VRRM[V]				Remarks
				40	60	90	150	
 41.0 x 16.0 x 5.0(mm)	TO-247AD — MTO-3PV	K7-2	40				S40T15V	
			90				S90T15V	

Single

Axial														
Package		Type No.	Absolute Maximum Ratings					Electrical Characteristics				Based on AEC-Q101	Automotive	Series
JEDEC Code JEITA Code House Name	Fig.		VRRM [V]	IF (AV) [A]	Conditions Ta [°C]	IFSM [A]	Tj [°C]	Vf (max) [V]	Conditions IF [A]	Ir (max) Vr=VRRM [mA]	Ct (typ) [pF]			
—	A1	D1NS4	40	1	59	30	150	0.55	1	0.8	50	—	—	S series
AX057		D1NS6	60	1	46	30	150	0.58	1	1	53	—	—	S series
—	A4-1	D2S4M	40	2	122 *1	60	150	0.55	2	2	95	—	—	S series
AX078		D2S6M	60	2	119 *1	60	150	0.58	2	2	90	—	—	S series
—	A7	D3S4M	40	3	63	80	150	0.55	3	3.5	150	—	—	S series
AX14		D3S6M	60	3	133 *1	80	150	0.58	3	2.5	130	—	—	S series

*1 : Tj

Two Terminal Type





Two Terminal Type														
Package		Type No.	Absolute Maximum Ratings					Electrical Characteristics				Based on AEC-Q101	Automotive	Series
JEDEC Code JEITA Code House Name	Fig.		VRRM [V]	IF (AV) [A]	Conditions Tc [°C]	IFSM [A]	Tj [°C]	Vf (max) [V]	Conditions IF [A]	Ir (max) Vr=VRRM [mA]	Ct (typ) [pF]			
—	J4	SG5S4M	40	5	131	150	150	0.52	5	0.5	157	—	—	S series
SC-91		SG5S6M	60	5	130	120	150	0.56	5	0.5	165	—	—	S series
FTO-220G		SG5S9M	90	5	124	90	150	0.75	5	0.5	140	—	—	S series

Three Terminal Type

Three Terminal Type														
Package		Type No.	Absolute Maximum Ratings					Electrical Characteristics				Based on AEC-Q101	Automotive	Series
JEDEC Code JEITA Code House Name	Fig.		VRRM [V]	IF (AV) [A]	Conditions Tc [°C]	IFSM [A]	Tj [°C]	Vf (max) [V]	Conditions IF [A]	Ir (max) Vr=VRRM [mA]	Ct (typ) [pF]			
TO-247AD	K7-2	S40T15V	150	40	131	700	150	0.92	40	0.12	595	—	○	N series
MTO-3PV		S90T15V	150	90	122	1400	150	0.95	90	0.35	1690	—	○	N series

SCHOTTKY BARRIER DIODES

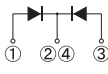
Center Tap, Common Cathode

Surface Mount											Remarks	
Package	JEDEC Code JEITA Code House Name	Fig.	IF (AV) [A]	VRRM[V]								
				30	40	60	90	100	120			150
 9.5 × 6.6 × 2.65(mm)	— SC-63 E-pack	G1-1	5	DE55C3ML	DE55C4M	DE55C6M						
			10	DE10SC3L	DE10SC4							
 9.5 × 6.6 × 2.65(mm)	TO-252AB similar SC-63 FE	G3-1	6		D6FEC4ST				D6FEC10ST	D6FEC12ST	D6FEC15ST	
 13.2 × 10.2 × 4.7(mm)	— SC-83 similar STO-220	H1-1	10		DF10SC4M	DF10SC6	DF10SC9				DF10NC15	
			15		DF15SC4M			DF15JC10		DF15NC15		
			20		DF20SC4M		DF20SC9M	DF20JC10		DF20NC15		
			25			DF25SC6M						
			30	DF30SC3ML	DF30JC4 DF30SC4M	DF30JC6		DF30JC10		DF30NC15		
 13.2 × 10.2 × 4.6(mm)	— SC-83 similar FD	H2-2	10						D10FDC10ST			
			20						D20FDC10ST		D20FDC15ST	
			30		D30FDC4S			D30FDC10ST		D30FDC15ST		
			40					D40FDC10ST		D40FDC15ST		

Center Tap, Common Cathode





Surface Mount															
JEDEC Code JEITA Code House Name	Package	Fig.	Type No.	Absolute Maximum Ratings				Electrical Characteristics				Based on AEC-Q101	Automotive	Series	
				VRRM [V]	IF (AV) [A]	Conditions Tc [°C]	IFSM [A]	Tj [°C]	Vf (max) [V]	Conditions IF [A]	Ir (max) Vr=VRRM [mA]				Ct (typ) [pF]
— SC-63 E-pack	G1-1		DE55C3ML	30	5	110	90	150	0.45	2.5	3.5	190	—	■	S series
			DE55C4M	40	5	101	80	150	0.55	2.5	3.5	150	—	■	S series
			DE55C6M	60	5	92	80	150	0.58	2.5	2.5	130	—	■	S series
			DE10SC3L	30	10	124	100	150	0.45	4	5	290	—	■	S series
TO-252AB similar SC-63 FE	G3-1		DE10SC4	40	10	132	100	150	0.55	5	3.5	210	—	■	S series
			D6FEC4ST	40	6	158	90	175	0.74	3	8μA	93	○	○	SL series
			D6FEC10ST	100	6	154	100	175	0.86	3	8μA	60	○	○	SL series
			D6FEC12ST	120	6	154	100	175	0.87	3	8μA	60	○	○	SL series
— SC-83 similar STO-220	H1-1		D6FEC15ST	150	6	154	100	175	0.88	3	8μA	52	○	○	SL series
			DF10SC4M	40	10	125	100	150	0.55	5	3.5	180	—	—	S series
			DF10SC6	60	10	132	150	150	0.58	5	4.5	260	—	—	S series
			DF10SC9	90	10	131	150	150	0.75	5	3	185	—	—	S series
			DF10NC15	150	10	123	100	150	0.88	5	0.2	110	—	—	N series
			DF15SC4M	40	15	129	150	150	0.55	7.5	5	340	—	—	S series
			DF15JC10	100	15	126	150	150	0.86	7.5	0.6	200	—	—	J series
			DF15NC15	150	15	126	150	150	0.88	7.5	0.3	155	—	—	N series
			DF20SC4M	40	20	122	230	150	0.55	10	7.5	390	—	—	S series
			DF20SC9M	90	20	111	200	150	0.75	10	10	370	—	—	S series
			DF20JC10	100	20	121	200	150	0.86	10	0.7	260	—	—	J series
			DF20NC15	150	20	121	200	150	0.88	10	0.4	200	—	—	N series
			DF25SC6M	60	25	115	300	150	0.58	12.5	10	490	—	—	S series
			DF30SC3ML	30	30	119	350	150	0.48	15	10	820	—	—	S series
			DF30JC4	40	30	115	250	150	0.61	15	0.7	560	—	—	J series
			DF30SC4M	40	30	112	360	150	0.55	15	10	590	—	—	S series
			DF30JC6	60	30	108	250	150	0.69	15	0.7	490	—	—	J series
			DF30JC10	100	30	116	300	150	0.86	15	1	390	—	—	J series
			DF30NC15	150	30	115	300	150	0.88	15	0.5	300	—	—	N series
			DF40SC3L	30	40	112	400	150	0.45	15	17	1200	—	—	S series
DF40SC4	40	40	106	350	150	0.55	20	14	860	—	—	S series			
— SC-83 similar FD	H2-2		D10FDC10ST	100	10	158	150	175	0.86	5	15μA	104	○	○	SL series
			D20FDC10ST	100	20	119	250	150	0.86	10	30μA	185	○	○	N series
			D20FDC15ST	150	20	118	250	150	0.88	10	30μA	159	—	—	N series
			D30FDC4S	40	30	114	300	150	0.55	15	1.5	415	○	○	S series
			D30FDC10ST	100	30	108	300	150	0.86	15	40μA	242	—	—	N series
			D30FDC15ST	150	30	107	300	150	0.88	15	40μA	209	—	—	N series
			D40FDC10ST	100	40	105	400	150	0.86	20	60μA	360	—	—	N series
			D40FDC15ST	150	40	103	400	150	0.88	20	60μA	315	—	—	N series

■ : Please contact us.

SCHOTTKY BARRIER DIODES

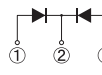
SCHOTTKY BARRIER DIODES

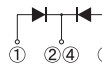
Center Tap, Common Cathode

Three Terminal Type														
Package	JEDEC Code JEITA Code House Name	Fig.	IF (AV) [A]	VRRM[V]							Remarks			
				15	30	40	60	90	100	120		150	600	
 28.5 × 10.0 × 4.5(mm)	SC-91 FTO-220G	J9	8			SG8SC4M								
			10		SG10SC3LM	SG10SC4M	SG10SC6M	SG10SC9M				SG10TC15M		
			15			SG15SC4M	SG15SC6M							
			20		SG20SC3LM	SG20SC4M	SG20JC6M SG20SC6M	SG20SC9M	SG20TC10M	SG20TC12M	SG20TC15M			
			30		SG30SC3LM	SG30SC4M	SG30JC6M SG30SC6M		SG30TC10M	SG30TC12M	SG30TC15M			
			40						SG40TC10M	SG40TC12M				
 41.0 × 16.0 × 5.0(mm)	TO-247AD MTO-3PT	K5-2	20			S30SC4MT	S30SC6MT				S30TC15T			
			30					S20SC9MT						
			40	S40HC1R5T										
			60	S60HC1R5T	S60HC3T S60SC3LT	S60SC4MT	S60SC6MT							
 41.0 × 16.0 × 5.0(mm)	TO-247AD MTO-3PV	K7-1	60						S60JC10V					



Center Tap, Common Cathode

Three Terminal Type																
JEDEC Code JEITA Code House Name	Fig.	Type No.	Absolute Maximum Ratings				Electrical Characteristics				Based on AEC-Q101	Automotive	Series			
			VRRM [V]	IF (AV) [A]	Conditions Tc [°C]	IFSM [A]	Tj [°C]	Vf (max) [V]	Conditions IF [A]	Ir (max) Vr=VRRM [mA]				Ct (typ) [pF]		
SC-91 FTO-220G	J9	SG8SC4M	40	8	155	80	175	0.56	4.0	0.3	100	-	-	S series		
		SG10SC3LM	30	10	136	150	150	0.45	4.0	5	310	-	-	S series		
		SG10SC4M	40	10	150	150	175	0.52	5.0	0.5	157	-	-	S series		
		SG10SC6M	60	10	145	140	175	0.56	5.0	0.5	165	-	-	S series		
		SG10SC9M	90	10	139	150	175	0.75	5.0	0.5	140	-	-	S series		
		SG10TC15M	150	10	153	120	175	0.88	5.0	15µA	92	-	-	SL series		
		SG15SC4M	40	15	117	150	150	0.52	7.5	0.8	230	-	-	S series		
		SG15SC6M	60	15	113	180	150	0.61	7.5	0.6	185	-	-	S series		
		SG20SC3LM	30	20	124	250	150	0.45	8.0	9	570	-	-	S series		
		SG20SC4M	40	20	115	200	150	0.52	10.0	1.1	315	-	-	S series		
		SG20JC6M	60	20	106	200	150	0.69	10.0	0.1	250	-	-	J series		
		SG20SC6M	60	20	107	200	150	0.61	10.0	0.8	250	-	-	S series		
		SG20SC9M	90	20	112	200	150	0.75	10.0	1	245	-	-	S series		
		SG20TC10M	100	20	140	200	175	0.86	10.0	30µA	185	-	-	SL series		
		SG20TC12M	120	20	137	200	175	0.87	10.0	30µA	175	-	-	SL series		
		SG20TC15M	150	20	136	200	175	0.88	10.0	30µA	159	-	-	SL series		
		SG30SC3LM	30	30	117	350	150	0.45	12.5	15	960	-	-	M series		
		SG30SC4M	40	30	101	300	150	0.55	15.0	1.5	415	-	-	S series		
		SG30JC6M	60	30	90	250	150	0.69	15.0	0.15	325	-	-	J series		
		SG30SC6M	60	30	100	300	150	0.61	15.0	1.2	385	-	-	S series		
		SG30TC10M	100	30	126	300	175	0.86	15.0	40µA	242	-	-	SL series		
		SG30TC12M	120	30	122	300	175	0.87	15.0	40µA	228	-	-	SL series		
		SG30TC15M	150	30	122	300	175	0.88	15.0	40µA	209	-	-	SL series		
		SG40TC10M	100	40	116	350	175	0.86	20.0	60µA	362	-	-	SL series		
		SG40TC12M	120	40	112	350	175	0.87	20.0	60µA	336	-	-	SL series		
		TO-247AD MTO-3PT	K5-2	S20SC9MT	90	20	136	200	150	0.75	10.0	1	245	-	-	S series
				S30SC4MT	40	30	132	300	150	0.55	15.0	1.5	410	-	-	S series
				S30SC6MT	60	30	129	300	150	0.61	15.0	1.2	385	-	-	S series
				S30TC15T	150	30	128	300	150	0.88	15.0	40µA	209	-	-	N series
				S40HC1R5T	15	40	111	450	125	0.41	20.0	10	960	-	-	H series
S60HC1R5T	15			60	110	600	125	0.41	30.0	15	1400	-	-	H series		
S60HC3T	30			60	112	650	125	0.40	30.0	20	1100	-	-	H series		
S60SC3LT	30			60	138	650	150	0.48	30.0	25	1600	-	-	S series		
S60SC4MT	40			60	127	500	150	0.55	30.0	3	790	-	-	S series		
S60SC6MT	60			60	121	470	150	0.67	30.0	2	640	-	-	S series		
TO-247AD MTO-3PV	K7-1	S60JC10V	100	60	118	500	150	0.95	30.0	0.2	695	-	○	J series		



SCHOTTKY BARRIER DIODES

SCHOTTKY BARRIER DIODES

Array

Surface Mount						
Package	JEDEC Code JEITA Code House Name	Fig.	I _{F(AV)} [A]	V _{RRM} [V]		Remarks
				40	60	
 7.0 × 4.7 × 2.6(mm)	TO-269AA - 1Z	C2-2	1.2	S1ZAS4		

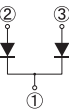
Diode Module

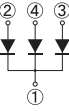
Surface Mount						
Package	JEDEC Code JEITA Code House Name	Fig.	I _{F(AV)} [A]	V _{RRM} [V]		Remarks
				40	60	
 43.0 × 27.0 × 21.0(mm)	- Module	F1	120	D120SC4M	D120SC6M	
			240	D240SC4M	D240SC6M	
 43.0 × 27.0 × 21.0(mm)		F3-1	180	D180SC4M	D180SC6M	
				360	D360SC4M	

Array

Surface Mount														
Package		Type No.	Absolute Maximum Ratings					Electrical Characteristics				Based on AEC-Q101	Automotive	Series
JEDEC Code JEITA Code House Name	Fig.		V _{RRM} [V]	I _{F(AV)} [A]	Conditions T _a [°C]	I _{FSM} [A]	T _J [°C]	V _F (max) [V]	Conditions I _F [A]	I _r (max) V _R =V _{RRM} [mA]	C _t (typ) [pF]			
TO-269AA - 1Z	C2-2	S1ZAS4	40	1.2	47	40	150	0.55	1	1	65	-	-	S series









Diode Module

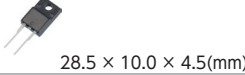

Surface Mount														
Package		Type No.	Absolute Maximum Ratings					Electrical Characteristics				Based on AEC-Q101	Automotive	Series
JEDEC Code JEITA Code House Name	Fig.		V _{RRM} [V]	I _{F(AV)} [A]	Conditions T _c [°C]	I _{FSM} [A]	T _J [°C]	V _F (max) [V]	Conditions I _F [A]	I _r (max) V _R =V _{RRM} [mA]	C _t (typ) [pF]			
- Module	F1	D120SC4M	40	120	90	800	125	0.58	60	40	2.1	-	-	S series
		D120SC6M	60	120	85	800	125	0.67	60	40	2.2	-	-	S series
		D240SC4M	40	240	77	1600	125	0.6	120	80	4.2	-	-	S series
	F3-1	D240SC6M	60	240	71	1600	125	0.67	120	80	4.4	-	-	S series
		D180SC4M	40	180	83	800	125	0.58	60	40	2.1	-	-	S series
		D180SC6M	60	180	78	800	125	0.67	60	40	2.2	-	-	S series
	D360SC4M	40	360	64	1600	125	0.6	120	80	4.2	-	-	S series	
	D360SC6M	60	360	58	1600	125	0.67	120	80	4.4	-	-	S series	

SCHOTTKY BARRIER DIODES



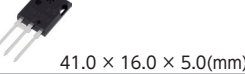

FAST RECOVERY DIODES

Single

Two Terminal Type							
Package	JEDEC Code JEITA Code House Name	Fig.	IF (AV) [A]	VRRM[V]			Remarks
				200	400	600	
 28.5 × 10.0 × 4.5(mm)	SC-91A FTO-220	J1	3			SF3L60U	
			5			SF5L60U	
			10			SF10L60U	
			20			SF20L60U	
 28.5 × 10.0 × 4.5(mm)	SC-91 FTO-220AG	J3	3			SF3K60M	
			5		SF5L40UM	SF5K60M	
			8			SF8K60USM SF8K60M	
			10			SF10K60M SF10L60MVM SF10L60MSM	
			20			SF20K60M SF20L60MVM SF20L60MSM	
			20			SF20L60MSM	
 28.5 × 10.0 × 4.5(mm)	SC-91 FTO-220G	J4	5			SG5L20USM	
			10			SG10L20USM	
 41.0 × 16.0 × 5.0(mm)	TO-247AD MTO-3PT	K2	20			S20K60T	
			30			S30K60T	

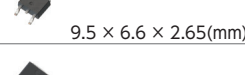
Three Terminal Type							
Package	JEDEC Code JEITA Code House Name	Fig.	IF (AV) [A]	VRRM[V]			Remarks
				600	1000	1200	
 41.0 × 16.0 × 5.0(mm)	TO-247AD MTO-3PV	K6	20			S20K100V	
			30			S30K60V S30K100V	

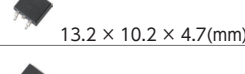
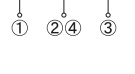
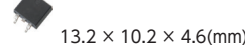
Center Tap, Common Cathode

Surface Mount								
Package	JEDEC Code JEITA Code House Name	Fig.	IF (AV) [A]	VRRM[V]				Remarks
				200	300	400	600	
 9.5 × 6.6 × 2.65(mm)	SC-63 E-pack	G1-1	5				DE5LC20U	
			10				DF10LC20U DF10LC30	
 13.2 × 10.2 × 4.7(mm)	SC-83 similar STO-220	H1-1	20				DF20LC20US DF20LC30	
			20				D20FDC20L D20FDC20LUS	
 13.2 × 10.2 × 4.6(mm)	SC-83 similar FD	H2-2	20				D20FDC20L D20FDC20LUS	
			20				D20FDC20LUS	

Single

Two Terminal Type														
Package		Type No.	Absolute Maximum Ratings					Electrical Characteristics				Based on AEC-Q101	Automotive	Series
JEDEC Code JEITA Code House Name	Fig.		VRRM [V]	IF (AV) [A]	Conditions Tc [°C]	IFSM [A]	Tj [°C]	Vf (max) [V]	Conditions IF [A]	Ir (max) Vr=VRRM [μA]	trr (max) [ns]			
SC-91A FTO-220	J1	SF3L60U	600	3	115	40	150	3.00	3	25	20	-	-	-
		SF5L60U	600	5	96	60	150	3.00	5	25	25	-	-	-
		SF10L60U	600	10	85	120	150	3.00	10	25	25	-	■	-
		SF20L60U	600	20	68	180	150	3.00	20	25	35	-	■	-
SC-91 FTO-220AG	J3	SF3K60M	600	3	132	90	150	1.45	3	10	80	-	-	K series
		SF5L40UM	400	5	121	100	150	1.25	5	10	30	-	■	-
		SF5K60M	600	5	119	120	150	1.50	5	10	85	-	■	K series
		SF8K60USM	600	8	70	60	150	3.60	8	50	25	-	-	US series
		SF8K60M	600	8	108	150	150	1.50	8	10	90	-	■	K series
		SF10K60M	600	10	106	180	150	1.50	10	10	95	-	-	K series
		SF10L60MVM	600	10	119	200	150	1.10	10	10	115	-	-	ML series
		SF10L60MSM	600	10	110	160	150	1.37	10	10	60	-	-	ML series
		SF20K60M	600	20	96	240	150	1.50	20	10	95	-	-	K series
		SF20L60MVM	600	20	106	250	150	1.10	20	10	130	-	-	ML series
SF20L60MSM	600	20	96	220	150	1.37	20	10	70	-	-	ML series		
SC-91 FTO-220G	J4	SG5L20USM	200	5	125	90	150	0.96	5	10	25	-	-	-
		SG10L20USM	200	10	101	200	150	0.96	10	10	25	-	-	-
TO-247AD MTO-3PT	K2	S20K60T	600	20	121	300	150	1.50	20	10	95	-	-	K series
		S30K60T	600	30	123	450	150	1.50	30	10	100	-	-	K series

■ : Please contact us.

Three Terminal Type														
Package		Type No.	Absolute Maximum Ratings					Electrical Characteristics				Based on AEC-Q101	Automotive	Series
JEDEC Code JEITA Code House Name	Fig.		VRRM [V]	IF (AV) [A]	Conditions Tc [°C]	IFSM [A]	Tj [°C]	Vf (max) [V]	Conditions IF [A]	Ir (max) Vr=VRRM [μA]	trr (max) [ns]			
TO-247AD MTO-3PV	K6	S20K100V	1000	20	127	550	150	2.10	20	10	120	-	○	K series
		S30K60V	600	30	108	450	150	1.50	30	10	100	-	○	K series
		S30K100V	1000	30	116	600	150	2.10	30	10	120	-	○	K series





Center Tap, Common Cathode

Surface Mount														
Package		Type No.	Absolute Maximum Ratings					Electrical Characteristics				Based on AEC-Q101	Automotive	Series
JEDEC Code JEITA Code House Name	Fig.		VRRM [V]	IF (AV) [A]	Conditions Tc [°C]	IFSM [A]	Tj [°C]	Vf (max) [V]	Conditions IF [A]	Ir (max) Vr=VRRM [μA]	trr (max) [ns]			
SC-63 E-pack	G1-1	DE5LC20U	200	5	81	50	150	0.98	2.5	10	35	-	■	-
		DF10LC20U	200	10	127	80	150	0.98	5	10	35	-	-	-
SC-83 similar STO-220	H1-1	DF10LC30	300	10	124	80	150	1.30	5	25	30	-	-	-
		DF20LC20US	200	20	125	180	150	0.96	10	10	25	-	-	-
		DF20LC30	300	20	124	180	150	1.30	10	10	25	30	-	-
SC-83 similar FD	H2-2	D20FDC20L	200	20	113	100	175	1.20	10	10	30	○	○	-
		D20FDC20LUS	200	20	125	180	150	0.96	10	10	25	-	○	-

■ : Please contact us.

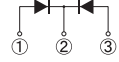
FAST RECOVERY DIODES

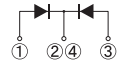
Center Tap, Common Cathode

Three Terminal Type								
Package	JEDEC Code JEITA Code House Name	Fig.	IF (AV) [A]	VRRM [V]				Remarks
				200	300	400	600	
 28.5 × 10.0 × 4.5(mm)	SC-91 FTO-220AG	J8-1	5			SF5LC40UM		
			10			SF10LC40UM	SF10KC60M	
			20		SF20LC30M		SF20KC60M	
 28.5 × 10.0 × 4.5(mm)	SC-91 FTO-220G	J9	5	SG5LC20USM				
			10	SG10LC20USM				
			20	SG20LC20USM				
 41.0 × 16.0 × 5.0(mm)	TO-247AD MTO-3PT	K5-2	20	S20LC20UST	S20LC30T	S20LC40UT	S20LC60UST	
 41.0 × 16.0 × 5.0(mm)	TO-247AD MTO-3PV	K7-1	20			S20LC40UV	S20LC60USV	

Center Tap, Common Cathode

Three Terminal Type														
Package		Type No.	Absolute Maximum Ratings					Electrical Characteristics				Based on AEC-Q101	Automotive	Series
JEDEC Code JEITA Code House Name	Fig.		VRRM [V]	IF (AV) [A]	Conditions Tc [°C]	IFSM [A]	Tj [°C]	Vf (max) [V]	Conditions IF [A]	Ir (max) Vr=VRRM [μA]	trr (max) [ns]			
SC-91 FTO-220AG	J8-1	SF5LC40UM	400	5	132	80	150	1.25	2.5	10	30	—	—	—
		SF10LC40UM	400	10	120	100	150	1.25	5	10	30	—	—	—
		SF10KC60M	600	10	109	120	150	1.50	5	10	85	—	■	K series
		SF20LC30M	300	20	107	250	150	1.30	10	25	30	—	—	—
		SF20KC60M	600	20	97	180	150	1.50	10	10	95	—	■	K series
SC-91 FTO-220G	J9	SG5LC20USM	200	5	133	70	150	0.96	2.5	10	25	—	—	—
		SG10LC20USM	200	10	122	90	150	0.96	5	10	25	—	—	—
		SG20LC20USM	200	20	95	150	150	0.96	10	10	25	—	—	—
TO-247AD MTO-3PT	K5-2	S20LC20UST	200	20	126	120	150	0.96	10	10	25	—	—	—
		S20LC30T	300	20	124	220	150	1.30	10	25	30	—	—	—
		S20LC40UT	400	20	123	130	150	1.25	10	10	30	—	—	—
		S20LC60UST	600	20	63	60	150	3.60	10	50	25	—	—	—
TO-247AD MTO-3PV	K7-1	S20LC40UV	400	20	123	200	150	1.25	10	10	30	—	○	—
		S20LC60USV	600	20	65	60	150	3.60	10	50	25	—	○	—

■ : Please contact us.



THYRISTORS

The Thyristor, in its normal state, will block an applied voltage in either direction, but when an appropriate current pulse is applied to the gate, current will flow through the anode to the cathode thus turning on power to the load circuit.

The Thyristor has a planar passivation, and is available in both the general reverse-blocking type and the type without reverse voltage.

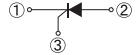

The Thyristor without reverse voltage is suitable for a circuit limiting inrush current.

Thyristors

Package	 10.0 × 6.6 × 2.3(mm)	 28.5 × 10.0 × 4.5(mm)		
JEDEC Code JEITA Code House Name	TO-252AA — FB	— SC-91 FTO-220AG		
Fig.	G2-2	J8-5		
Internal Circuit				
$I_T(AV)$ [A]	3	5	5	8
V_{DRM} [V]	400 600 800	KC3FB40H KC5FB60H KC5FB60HR KC5FB60HRT	KC55SF60HRT	KC8SF80

 : New product

Thyristors

Package		Type No.	Absolute Maximum Ratings						Electrical Characteristics					Based on AEC-Q101	Automotive
JEDEC Code JEITA Code House Name	Fig.		V_{DRM} [V]	V_{RRM} [V]	I_T (AV) [A]	Conditions T_C [°C]	I_{TSM} [A]	T_J [°C]	V_{TM} (max) [V]	Conditions I_{TM} [A]	V_{GT} (max) [V]	I_{GT} (max) [μA]	I_H (max) [mA]		
TO-252AA — FB	G2-2	KC3FB40H	400	400	3	111	40	-40 to 125	1.4	4	0.8	100	5	—	—
		KC5FB40H	400	400	5	101	65	-40 to 125	1.6	10	0.8	200	typ.1	—	—
		KC5FB60H	600	600	5	98	90	-40 to 125	1.8	15	0.8	100	5	—	—
		KC5FB60HR	600	—	5	98	90	-40 to 125	1.8	15	0.8	100	5	—	—
		KC5FB60HRT	600	—	5	123	90	-55 to 150	1.8	15	0.8	100	5	—	—
— SC-91 FTO-220AG	J8-5	 KC55SF60HRT	600	—	5	127	82	-40 to 150	1.8	15	0.8	100	5	—	—
 KC8SF80		800	800	8	130	120	-40 to 150	1.5	20	1.0	15mA	100	—	—	



 : New product

SIDACs

SIDAC series are semiconductor devices energized by the addition of a specific voltage. They are commonly used for switching devices or pulse generating devices.



Bi-directional (K1V series)

- Features**
 1. Symmetrical characteristics.
 2. Operating directly from the AC mains, and can be used in all kinds of pulse generating circuits.
 3. The glass passivation ensures high reliability.
- Applications**
 1. Pulse generation : gas igniters,HID(high intensity discharge)lamp drive circuit,etc.
 2. AC switching : drive circuit for switching power supplies,voltage detecting circuits,etc.
 3. Over voltage protection : AC line surge protection,capacitor rupture prevention,etc.

Package			
JEDEC Code JEITA Code House Name	DO-214AC — 1F	— — AX06	— — AX10
Fig.	B4-3	A2-1	A5-3 A6
Internal Circuit	①—N—②		
V _{DRM} [V]	5	K1VZL09	
	15	K1VZL20	
	90	K1V(A)10 K1V(A)11 K1V(A)12	K1V10 K1V11 K1V12
	115	K1V(A)16	K1V14
	180		K1V22 K1V24 K1V26
	270		K1V22(W) K1V24(W) K1V26(W) K1V36(W) K1V38(W)

Uni-directional (G1V series)

- Features**
 1. Uni-directional characteristics.
 2. Smaller package than bi-directional SIDAC.
 3. Switching operation from DC power for pulse generation.
 4. The glass passivation ensures high reliability.
- Applications**
 1. Pulse generation : gas igniters,negative ion generators, HID(high intensity discharge) lamp drive circuit,etc.
 2. Over voltage protection : DC line surge protection.

Package				
JEDEC Code JEITA Code House Name	DO-214AC — 1F	— — AX06	— — AX078	
Fig.	B3-3	A2-3	A4-3	
Internal Circuit	①—N—②			
V _{DRM(A)} [V]	70	G1VL8C	G1V(A)8C	
	90	G1VL10C	G1V(A)10C	
	100		G1V(A)12C	
	110		G1V(A)13C	
	115		G1V(A)15C	
	120	G1VL15C	G1V(A)14C	
	170	G1VL20C	G1V(A)20C	G1V(B)20C
	190	G1VL22C G1VL24C		G1V(B)22C
	210			G1V(B)24C

Bi-directional (K1V series)

Surface Mount		Type No.	Absolute Maximum Ratings					Electrical Characteristics					Automotive		
JEDEC Code JEITA Code House Name	Fig.		V _{DRM} [V]	I _T [A]	Conditions T _L [°C]	T _{stg} [°C]	T _J [°C]	V _{BO} [V]	I _{DRM} (max) [μA]	Conditions V _D [V]	I _{BO} (max) [mA]	I _H (typ) [mA]		V _T (max) [V]	Conditions I _T [A]
DO-214AC — 1F	B4-3	K1VZL09	5	0.5	110	-40 to 125	125	8 to 12	5	5	20	20	1.2	0.5	—
		K1VZL20	15	0.5	110	-40 to 125	125	18 to 22	5	15	20	20	1.2	0.5	—

Axial		Type No.	Absolute Maximum Ratings							Electrical Characteristics					Automotive		
JEDEC Code JEITA Code House Name	Fig.		V _{DRM} [V]	I _T [A]	Conditions T _L [°C]	I _{TSM} [A]	I _{TRM} [A]	Conditions f [Hz]	dit/dt [A/μs]	T _J [°C]	V _{BO} [V]	I _H (typ) [mA]	V _T (max) [V]	Conditions I _T [A]		R _s (min) [kΩ]	
— — AX06	A2-1	K1V(A)10	90	1	109	16	60	60	50	125	95 to 113	50	1.6	1	0.1	—	
		K1V(A)11	90	1	109	16	60	60	50	125	104 to 118	50	1.6	1	0.1	—	
		K1V(A)12	90	1	109	16	60	60	50	125	110 to 125	50	1.6	1	0.1	—	
		K1V(A)16	115	1	98	16	60	60	50	125	145 to 170	50	1.6	1	0.1	—	
	— — AX10	A5-3	K1V10	90	1	112	20	80	60	80	125	95 to 113	50	1.5	1	0.1	—
			K1V11	90	1	112	20	80	60	80	125	104 to 118	50	1.5	1	0.1	—
			K1V12	90	1	112	20	80	60	80	125	110 to 125	50	1.5	1	0.1	—
			K1V14	115	1	109	20	80	60	80	125	125 to 150	30	1.5	1	0.1	—
		A6	K1V22	180	1	108	20	50	60	80	125	200 to 230	20	1.5	1	0.1	—
			K1V24	180	1	108	20	50	60	80	125	220 to 250	20	1.5	1	0.1	—
			K1V26	180	1	108	20	50	60	80	125	240 to 270	20	1.5	1	0.1	—
			K1V22(W)	180	1	91	16	50	60	80	125	200 to 230	50	3	1	0.1	—
K1V24(W)			180	1	91	16	50	60	80	125	220 to 250	50	3	1	0.1	—	
K1V26(W)			180	1	91	16	50	60	80	125	240 to 265	50	3	1	0.1	—	
K1V36(W)			270	1	92	13	40	60	50	125	340 to 380	50	3	1	0.1	—	
K1V38(W)			270	1	92	13	40	60	80	125	360 to 400	50	3	1	0.1	—	

Uni-directional (G1V series)

Surface Mount		Type No.	Absolute Maximum Ratings					Electrical Characteristics					Automotive	
JEDEC Code JEITA Code House Name	Fig.		V _{DRM(A)} [V]	I _T [A]	Conditions T _L [°C]	I _{TRM} [A]	Conditions f [Hz]	dit/dt [A/μs]	T _J [°C]	V _{BO} [V]	I _H (max) [mA]	V _T (max) [V]		Conditions I _T [A]
DO-214AC — 1F	B3-3	G1VL8C	70	1	98	80	60	150	125	75 to 90	100	1.5	1	—
		G1VL10C	90	1	98	150	60	150	125	95 to 110	100	1.5	1	—
		G1VL15C	120	1	98	120	60	150	125	142 to 157	60	1.5	1	—
		G1VL20C	170	1	98	120	60	150	125	190 to 210	60	1.5	1	—
		G1VL22C	190	1	98	280	5	150	125	210 to 230	60	1.5	1	—
		G1VL24C	190	1	98	280	5	150	150	230 to 250	60	1.5	1	—

Axial		Type No.	Absolute Maximum Ratings					Electrical Characteristics					Automotive	
JEDEC Code JEITA Code House Name	Fig.		V _{DRM(A)} [V]	I _T [A]	Conditions T _L [°C]	I _{TRM} [A]	Conditions f [Hz]	dit/dt [A/μs]	T _J [°C]	V _{BO} [V]	I _H (max) [mA]	V _T (max) [V]		Conditions I _T [A]
— — AX06	A2-3	G1V(A)8C	70	1	98	80	60	80	125	75 to 90	100	1.5	1	—
		G1V(A)10C	90	1	98	80	60	80	125	95 to 110	60	1.5	1	—
		G1V(A)12C	100	1	98	80	60	80	125	110 to 130	60	1.5	1	—
		G1V(A)13C	110	1	98	80	60	80	125	120 to 138	60	1.5	1	—
		G1V(A)14C	120	1	98	80	60	80	125	130 to 150	60	1.5	1	—
		G1V(A)15C	115	1	98	80	60	80	125	142 to 157	60	1.5	1	—
— — AX078	A4-3	G1V(A)20C	170	1	98	80	60	80	125	190 to 210	60	1.5	1	—
		G1V(B)22C	190	1	98	160	60	220	125	190 to 210	60	1.5	1	—
		G1V(B)24C	210	1	102	120	60	220	150	210 to 230	60	1.5	1	—









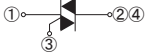
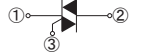

TRIACs

TRIACs are bidirectional Thyristors.

Our TRIACs are easy to use for motor and heater controls due to balanced gate sensitivity and $(di/dt)_c$.

Our lineup ranges from $V_{DRM}=600$ to 800V, $I_{T(RMS)}=3$ to 20A.

TRIACs (Triode for Alternating Current)







Package	 10.0 × 6.6 × 2.3(mm)	 28.5 × 10.0 × 4.5(mm)
JEDEC Code JEITA Code House Name	TO-252AA — FB	— SC-91 FTO-220AG
Fig.	G2-3	J8-4
Internal Circuit		
V_{DRM} [V]	600	
$I_{T(RMS)}$ [A]	3	 KD3FB60
	5	 KD3SF60E  KD3SF60
	8	 KD5SF60
	12	 KD8SF60
	16	 KD12SF60
	20	 KD16SF60  KD20SF60

 : New product

TRIACs (Triode for Alternating Current)

Surface Mount		Type No.	Absolute Maximum Ratings			Electrical Characteristics						Based on AEC-Q101	Automotive
JEDEC Code JEITA Code House Name	Fig.		I_T (RMS) [A]	V_{DRM} [V]	T_J [°C]	V_{TM} (max) [V]	Conditions I_{TM} [A]	V_{GT} (max) (I, II, III)* [V]	I_{GT} (max) (I, II, III)* [mA]	$(dv/dt)_c$ ($T_J=150^\circ\text{C}, V_D=2/3V_{DRM}$) [V/ μs]	Conditions $(di/dt)_c$ [A/ms]		
TO-252AA — FB	G2-3	 KD3FB60	3	600	-40 to 150	1.7	4.5	1.5	15	1	-1.5	—	—

 : New product * : Operation mode IV is not guaranteed.

Two Terminal Type		Type No.	Absolute Maximum Ratings			Electrical Characteristics						Based on AEC-Q101	Automotive
JEDEC Code JEITA Code House Name	Fig.		I_T (RMS) [A]	V_{DRM} [V]	T_J [°C]	V_{TM} (max) [V]	Conditions I_{TM} [A]	V_{GT} (max) (I, II, III)* [V]	I_{GT} (max) (I, II, III)* [mA]	$(dv/dt)_c$ ($T_J=150^\circ\text{C}, V_D=2/3V_{DRM}$) [V/ μs]	Conditions $(di/dt)_c$ [A/ms]		
— SC-91 FTO-220AG	J8-4	 KD3SF60E	3	600	-40 to 150	1.5	4.5	1.5	10	—	—	—	—
		 KD3SF60	3	600	-40 to 150	1.5	4.5	1.5	20	1	-1.5	—	—
		 KD5SF60	5	600	-40 to 150	1.8	7	1.5	20	1	-2.5	—	—
		 KD8SF60	8	600	-40 to 150	1.6	12	1.5	30	1	-4.0	—	—
		 KD12SF60	12	600	-40 to 150	1.6	20	1.5	30	1	-6.0	—	—
		 KD16SF60	16	600	-40 to 150	1.5	25	1.5	30	1	-8.0	—	—
 KD20SF60	20	600	-40 to 150	1.4	30	1.5	30	1	-10.0	—	—		

 : New product * : Operation mode IV is not guaranteed.

Operation Mode	Terminal Characteristics		
	① T1	②④ T2	③ G
I	—	+	+
II	—	+	—
III	+	—	—
IV	+	—	+





SURGE ABSORBERS

Surge Absorbers are semiconductor devices of the Thyristor type that turns on when triggered by their rated voltage. They are commonly used for lightning surge protection in communications equipment.

Thyristor Surge Suppressors

- Features
 1. Bi-directional or uni-directional characteristics.
 2. High speed response.
 3. Large surge current capacity.
 4. Repetitive use against surges is possible.

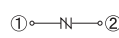

- Applications
 1. Lightning surge adsorption for communications circuits.
 2. Lightning surge adsorption for transmitters and switchboards.
 3. Surge protection for ISDN terminals.

Series	KL Series	KU Series	KP Series	
Package	 5.0 × 2.5 × 2.0(mm)	 5.1 × 3.75 × 2.0(mm)	 7.6 × 4.0 × 2.8(mm)	
JEDEC Code JEITA Code House Name	DO-214AC - 1F	DO-214AA similar - M2F	- - 2F	
Fig.	B4-3	B7 B8	B9-4	
Internal Circuit				
Off-state Voltage V _D [V]	5	KL3Z07		
	15	KL3Z18		
	58	KL3L07		
	63		KU10L08	
	70		KU4F8	
	90		KU10NU11	
	92			KP20NU11 KP40NU11
	100		KU4F12	
	115		KU10NU13	
	120	KL3N14	KU10N14 KU15N14	
	175	KL3R20		
	180			KP40RU22
	190		KU10R23NS	
	220		KU10R27NS	
250		KU10R29NS		
275		KU5S31NS KU10S31NS KU10S35NS		

Varistor

- Features
 1. Bi-directional surge absorption is possible.
 2. Low junction capacitance.

- Applications
 1. Telephone set surge absorption.
 2. Digital communications circuit surge absorption.
 3. ISDN terminal surge absorption.

Package	 5.0 × 2.5 × 2.0(mm)
JEDEC Code JEITA Code House Name	DO-214AC - 1F
Fig.	B4-1
Internal Circuit	
V _{F2} [V]	2.75 ± 0.25 VR-61F1

Thyristor Surge Suppressors

Package		Type No.	Absolute Maximum Ratings				Electrical Characteristics			UL	Automotive
JEDEC Code JEITA Code House Name	Fig.		I _{TSM} [A]	Conditions [μs]	V _{DRM} [V]	T _J [°C]	V _{BO} (min) [V]	I _H (min) [mA]	C _t (max) [pF]		
DO-214AC - 1F	B4-3	KL3Z07	30	10/1000	5	125	5.5 *1	50	-	-	-
		KL3Z18	30	10/1000	15	125	15.5 *1	50	-	-	-
		KL3L07	30	10/1000	58	125	65	100	90	-	-
		KL3N14	30	10/1000	120	125	130	100	50	-	-
		KL3R20	30	10/1000	175	125	180	100	30	-	-
DO-214AA similar - M2F	B7	KU10L08	100	10/1000	63	125	70	100	180	UL*	-
		KU4F8	40	10/1000	70	125	75	100	100	-	-
	B8	KU10NU11	100	10/1000	60	125	100	150	-	-	-
		KU4F12	40	10/1000	100	125	110	100	100	-	-
		KU10NU13	100	10/1000	60	125	120	100	-	-	-
		KU10N14	100	10/1000	120	125	125	100	140	UL*	-
		KU15N14	150	10/1000	120	125	125	100	110	UL*	-
		KU10R23NS	100	10/1000	190	125	290 *2	100	90	-	-
		KU10R27NS	100	10/1000	220	125	320 *2	100	70	UL*	-
		KU10R29NS	100	10/1000	250	125	400 *2	100	70	UL*	-
B9-4	KU5S31NS	50	10/1000	275	125	420 *2	150	70	-	-	
	KU10S31NS	100	10/1000	275	125	420 *2	100	90	UL*	-	
- 2F	B9-4	KU10S35NS	100	10/1000	275	125	450 *2	100	90	-	-
		KP20NU11	325	10/700	60	125	100	150	295 *3	-	-
		KP40NU11	500	10/700	60	125	100	150	485 *3	-	-
		KP40RU22	500	10/700	60	125	195	100	285 *3	-	-

*1 : V_{BR} *2 : V_{CL}(max) *3 : typ.  : UL497B recognized (UL File No.E183905)

Varistor

Package		Type No.	Absolute Maximum Ratings			Electrical Characteristics		Automotive
JEDEC Code JEITA Code House Name	Fig.		I _{F(RMS)} [mA]	I _{FSM} [A]	T _J [°C]	V _{F1} [V]	Conditions I _F [mA]	
DO-214AC - 1F	B4-1	VR-61F1	370	7.5	150	2.3 ± 0.25	1	-

TVS (Transient Surge Suppressor)

TVSs are low voltage PN junction type devices. These devices utilize technologically stable glass passivation (an in-house design) with a structural advantage that brings high resistance against heat and humidity. They are available with a voltage range between 12 to 320V and peak pulse power from 200 to 8000W.

TVS (Transient Voltage Suppressor)

- Features**
 - 1.High speed response.
 - 2.Absorption energy tolerance capacity.
 - 3.Narrow clamping voltage width.
- Applications**
 - 1.IC protection for telephones.
 - 2.IC protection against abnormal voltage.
 - 3.Protection for load dump noise.

Peak pulse power	200W	600W	2000W	6000 ~ 8000W (Load Dump Surge Protecting)
Package	3.5 x 1.6 x 0.8(mm)	5.0 x 2.5 x 2.0(mm)	4.7 x 2.4 x 0.98(mm)	7.6 x 4.0 x 2.8(mm) 9.0 x 7.0 x 9.0(mm) 13.2 x 10.2 x 4.7(mm) 15.0 x 10.2 x 4.0(mm)
JEDEC Code JEITA Code House Name Fig.	DO-219AB similar SC-109 G1F B1-2	DO-214AC 1F B3-2	DO-214AC 1F B4-2	SC-110B CE B5-2 2F B9-5 B10
Internal Circuit				
V _{BR} (typ) [V]	12.5 14 16 18 20 24 27 30 33 36 39 40 43 47 48 58 68 75 82 100 120 145 170 200 240 280 320	ST02-12G1 ST02-14G1 ST02-16G1 ST02-18G1 ST02-20G1 ST02-24G1 ST02-27G1 ST02-30G1 ST02-33G1 ST02-36G1 ST02-39G1 ST02-43G1 ST02-47G1 ST02-58G1 ST03-68F1 ST02-75F1 ST02-82F1 ST02-100F1 ST02-120F1 ST02-140F1 ST02-170F1 ST02-200F1 ST03-240F1 ST02-280F1 ST02-320F1	ST04-12F1 ST04-14F1 ST04-16F1 ST04-18F1 ST04-20F1 ST04-24F1 ST04-27F1 ST04-30F1 ST04-33F1 ST04-36F1 ST04-39F1 ST03-43F1 ST03-47F1 ST03-58F1 ST03-68F1 ST02-75F1 ST02-82F1 ST02-100F1 ST02-120F1 ST02-140F1 ST02-170F1 ST02-200F1 ST03-240F1 ST02-280F1 ST02-320F1	DL04-18F1 DL04-33F1 DL04-36F1 ST06-18CE ST06-27CE ST06-30CE ST06-33CE ST06-36CE ST06-39CE ST06-40MF ST06-48MF ST02-47F2 ST20-47F2 ST60-40MF ST60-48MF

■ : New product

TVS (Transient Voltage Suppressor)

Package JEDEC Code JEITA Code House Name	Fig.	Type No.	Absolute Maximum Ratings			Electrical Characteristics				Based on AEC-Q101	Automotive			
			PRSM [W]	T _j [°C]	V _R (DC) [V]	V _{BR} (min) [V]	V _{BR} (max) [V]	Conditions I _R [mA]	I _R (max) [μA]			Conditions V _R [V]		
DO-219AB similar SC-109 G1F	B1-2	ST02-12G1	200	-55 to 175	9	11.5	13.5	5	5	9	○	○		
		ST02-14G1	200	-55 to 175	12.8	13.5	15	5	5	12.8	○	○		
		ST02-16G1	200	-55 to 175	13.6	14.4	17.6	5	5	13.6	○	○		
		ST02-18G1	200	-55 to 175	13	16.8	19.1	5	5	13	○	○		
		ST02-20G1	200	-55 to 175	16	18.8	22	5	5	16	○	○		
		ST02-24G1	200	-55 to 175	20	22	25.6	5	5	20	○	○		
		ST02-27G1	200	-55 to 175	23	25.1	28.9	2	5	23	○	○		
		ST02-30G1	200	-55 to 175	24	28	32	2	5	24	○	○		
		ST02-33G1	200	-55 to 175	25	31	35	2	5	25	○	○		
		ST02-36G1	200	-55 to 175	27	34	38	2	5	27	○	○		
		ST02-39G1	200	-55 to 175	30	37	41	2	5	30	○	○		
		ST02-43G1	200	-55 to 175	33	40	45	2	5	33	○	○		
		ST02-47G1	195	-55 to 175	37	42	52	2	5	37	■	○		
		ST02-58G1	175	-55 to 175	45	52	64	2	5	45	○	○		
		DO-214AC 1F	B3-2	ST04-12F1	400	-55 to 175	9	11.5	13.5	1	5	9	○	○
ST04-14F1	400			-55 to 175	12.8	13.5	15	1	5	12.8	○	○		
ST04-16F1	400			-55 to 175	13.6	14.4	17.6	1	5	13.6	○	○		
ST04-18F1	400			-55 to 175	15.3	16.8	19.1	1	5	15.3	○	○		
ST04-20F1	400			-55 to 175	16	18.8	21.2	1	5	16	○	○		
ST04-24F1	400			-55 to 175	20	22.8	25.6	1	5	20	○	○		
ST04-27F1	400			-55 to 175	23	24.3	29.7	1	5	23	○	○		
ST04-30F1	400			-55 to 175	24	28	32	1	5	24	○	○		
ST04-33F1	400			-55 to 175	25	31	35	1	5	25	○	○		
ST04-36F1	400			-55 to 175	27	34	38	1	5	27	○	○		
ST04-39F1	400			-55 to 175	30	37	41	1	5	30	○	○		
ST03-43F1	300			-55 to 150	33	40	45	1	5	33	○	○		
ST03-47F1	300			-55 to 150	37	42	52	1	5	37	○	○		
ST03-58F1	300			-55 to 150	45	52	64	1	5	45	○	○		
ST03-68F1	300			-55 to 150	58	64.4	71.2	1	5	58	○	○		
ST02-75F1	200			-55 to 150	61	70	79	1	5	61	○	○		
ST02-82F1	200			-55 to 150	67	74	90	1	5	67	○	○		
ST02-100F1	200			-55 to 150	80	90	110	1	5	80	○	○		
ST02-120F1	200			-55 to 150	100	110	130	1	5	33	■	○		
ST02-140F1	200			-55 to 150	120	130	160	1	5	120	■	○		
ST02-170F1	200			-55 to 150	145	155	185	1	5	145	■	○		
ST02-200F1	200			-55 to 150	170	185	215	1	5	170	■	○		
ST03-240F1	310			-55 to 175	200	220	250	1	5	200	■	○		
ST02-280F1	200			-55 to 175	230	250	300	1	5	230	○	○		
ST02-320F1	150			-55 to 175	260	300	350	1	5	260	○	○		
DO-214AC 1F	B4-2			DL04-18F1	400	-55 to 150	13	16.8	19.1	5	5	13	○	○
				DL04-33F1	400	-55 to 175	25	31	35	1	5	25	○	○
				DL04-36F1	400	-55 to 175	27	34	38	1	5	27	○	○
SC-110B CE	B5-2			ST06-18CE	600	-55 to 175	13	16.8	19.1	1	5	13	○	○
				ST06-27CE	600	-55 to 175	23	25	29	1	5	23	○	○
				ST06-30CE	600	-55 to 175	24	28	32	1	5	24	○	○
				ST06-33CE	600	-55 to 175	25	31	35	1	5	25	○	○
				ST06-36CE	600	-55 to 175	27	34	38	1	5	27	○	○
2F	B9-5 B10	ST06-39CE	600	-55 to 175	30	37	41	1	5	30	○	○		
		ST20-47F2	1700	-55 to 175	37	42	52	1	5	37	○	○		
		ST20-27F2	2000	-55 to 175	23	24.3	29.7	1	5	23	○	○		
		ST20-30F2	2000	-55 to 175	24	28	32	1	5	24	-	○		
MCP	E1	ST20-33F2	2000	-55 to 175	25	31	35	1	5	25	○	○		
		ST20-36F2	2000	-55 to 175	27	34	38	1	5	27	-	○		
		ST80-14MF	8000	-40 to 150	12	13	15	1	10	12	-	○		
		ST70-27MF	7000	-40 to 150	23	24.3	29.7	1	5	23	-	○		
SC-83 similar STO-220 TO-263AB FZ	H1-6 H6	ST70-30MF	7000	-40 to 150	26	27.5	33	1	5	26	-	○		
		ST60-40MF	6000	-40 to 150	32	36.5	44	1	5	32	-	○		
		ST60-48MF	6000	-40 to 150	40	43.2	54	1	5	40	-	○		
		ST70-27F	7000	-40 to 150	23	24.3	29.7	1	5	23	-	○		
FZ	H6	ST70-27FZ	7000	-55 to 175	23	25	29	1	5	23	○	○		





■ : New product ■ : Please contact us.

TVS (Transient Surge Suppressor)

Power Clampers

- Features
- 1.High speed response.
 - 2.Absorption energy tolerance capacity.
 - 3.Narrow clamping voltage width.
 - 4.Reverse blocking type.

- Application 1.Snubber circuit in the primary side of switch-mode power supplies.

Package	 7.6 × 4.0 × 2.8(mm)	 5.0 × φ 4.0(mm)	 7.0 × φ 4.4(mm)
JEDEC Code	—	—	—
JEITA Code	—	—	—
House Name	2F	AX078	AX10
Fig.	B9-3	A4-2	A5-2
Internal Circuit			
VBR (typ) [V]	82	ST02D-82	ST03D-82
	145	ST02D-140	ST03D-140
	170	ST02D-170F2	ST03D-170
	200	ST02D-200	ST03D-200
	240		ST03DH-240
	280		★ ST02DH-280
320		★ ST02DH-320	

★ : Under development

Power Clampers

Surface Mount		Absolute Maximum Ratings					Electrical Characteristics						Automotive
Package		PrSM	Tj	V _{RM} (max)		ZD			Di				
JEDEC Code	Fig.			Type No.	[W]	[°C]	ZD	Di	V _{BR} (min)	V _{BR} (max)	Conditions I _R [mA]	I _R (max) [μA]	
—	B9-3	ST02D-140F2	200	-40 to 150	120	600	130	160	1	5	5	600	—
2F		ST02D-170F2	200	-40 to 150	145	600	155	185	1	5	5	600	—

Axial		Absolute Maximum Ratings					Electrical Characteristics						Automotive
Package		PrSM	Tj	V _{RM} (max)		ZD			Di				
JEDEC Code	Fig.			Type No.	[W]	[°C]	ZD	Di	V _{BR} (min)	V _{BR} (max)	Conditions I _R [mA]	I _R (max) [μA]	
—	AX078	ST02D-82	200	-40 to 150	67	600	74	90	1	5	5	600	—
		ST02D-140	200	-40 to 150	120	600	130	160	1	5	5	600	—
		ST02D-170	200	-40 to 150	145	600	155	185	1	5	5	600	—
		ST02D-200	200	-40 to 150	170	600	185	215	1	5	5	600	—
—	AX10	ST03D-82	300	-40 to 150	67	600	74	90	1	5	5	600	—
		ST03D-140	300	-40 to 150	120	600	130	160	1	5	5	600	—
		ST03D-170	300	-40 to 150	145	600	155	185	1	5	5	600	—
		ST03D-200	300	-40 to 150	170	600	185	215	1	5	5	600	—
		ST03DH-240	300	-40 to 150	200	1000	220	250	1	5	10	1000	—
		★ ST02DH-280	300	-40 to 150	230	1000	250	300	1	5	10	1000	—
★ ST02DH-320	300	-40 to 150	260	1000	300	350	1	5	10	1000	—		

★ : Under development

POWER MODULES

Power Modules include combinations of various power semiconductors. They are easy to design, reduce the number of components needed in the device, are suitable for device downsizing, and mitigate heat-dissipation concerns. At Shindengen, a multitude of packages allow us to meet customer needs of MOSFET, diodes, and other products. Semi customizable support and customizable package design support are available.

Transfer Type Package Sample

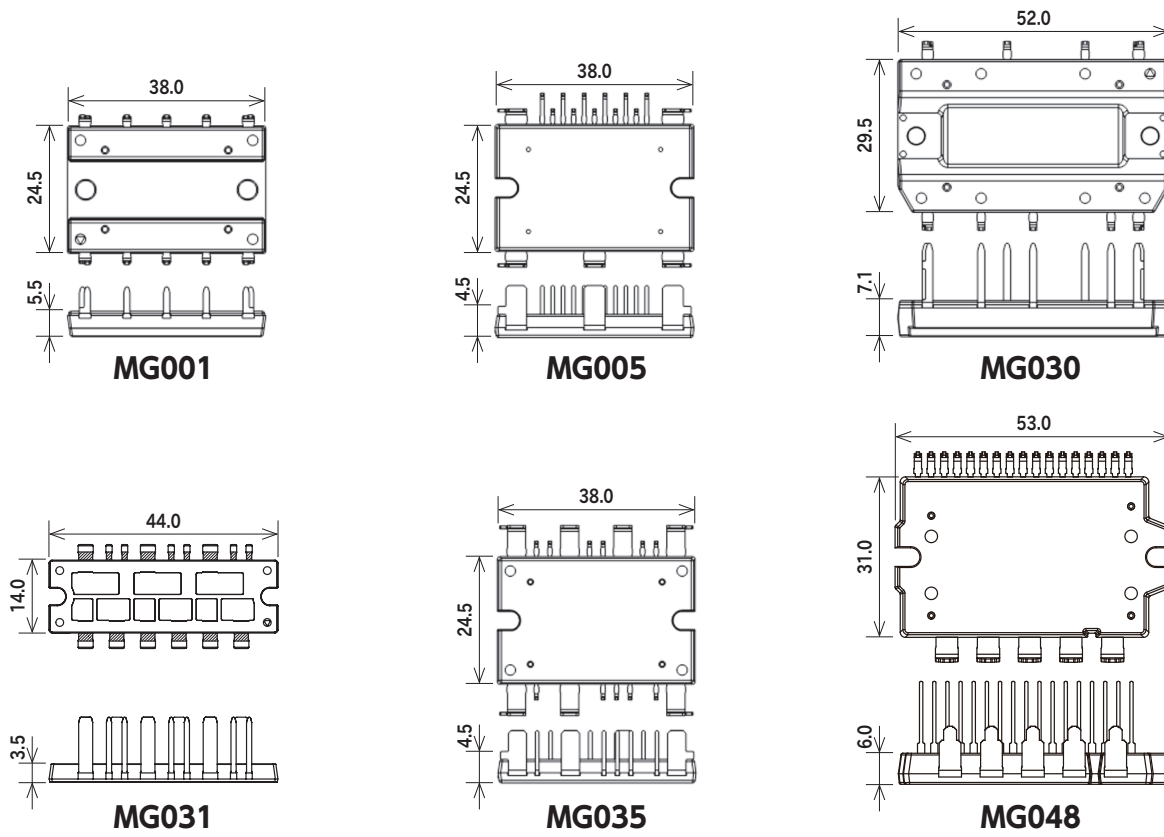

Potting Type Package Sample

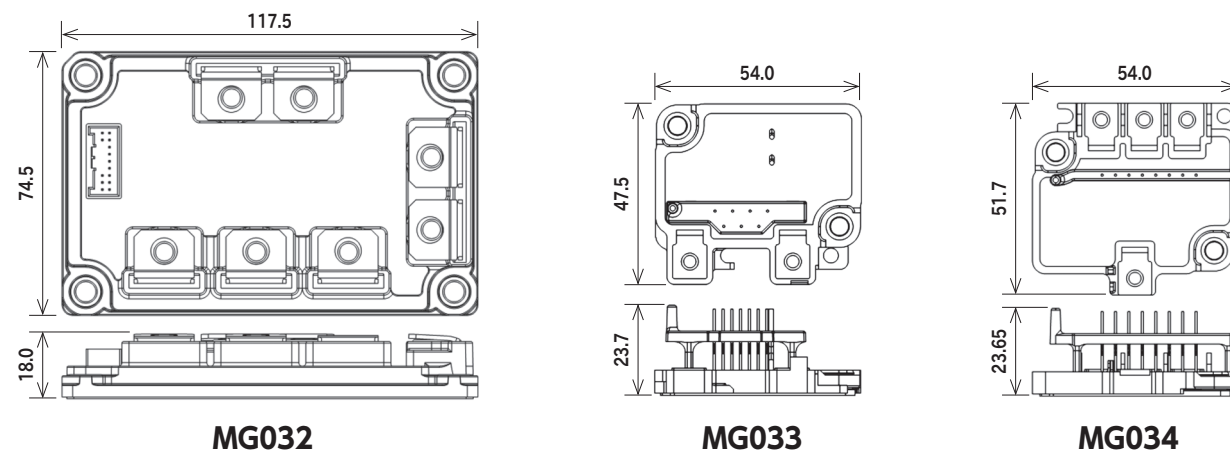

CB Module Series

Converter + Brake Modules

Type No.	Package		Converter Diode				Brake IGBT				Brake FRD				UL	Automotive			
			Absolute Maximum Ratings		Electric Characteristics		Absolute Maximum Ratings		Electric Characteristics		Absolute Maximum Ratings		Electric Characteristics						
	JEDEC Code JEITA Code House Name	Fig.	VRRM [V]	IF (AV) [A]	Conditions Tc [°C]	Vf (max) [V]	Conditions IF [A]	VCES [V]	Ic [A]	VCE (sat) (typ) [V]	Conditions Ic [A]	VRRM [V]	IF (AV) [A]	Conditions Tc [°C]			Vf (max) [V]	Conditions IF [A]	ttr (max) [ns]
MG020200	-	-	600	20.0	137	1.05	7.0	600	28.0	2.10	15.0	600	3.0	137	1.65	3.0	50	UL	-
MG020201	-	MG001	600	30.0	136	1.05	10.0	600	30.0	2.00	30.0	600	3.0	137	1.65	3.0	50	UL	-

UL: UL recognize (UL File No. E142422)

Equivalent Circuit Schematic

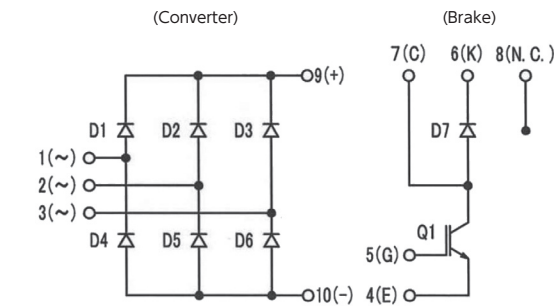

MG001

INV Module Series

Inverter Modules

Type No.	Package		Absolute Maximum Ratings					Electrical Characteristics						UL	Automotive
			Vdss [V]	Id [A]	Idp [A]	Pt [W]	Tch [°C]	Rds(ON) (typ) [mΩ] Vgs=10V	Rds(ON) (max) [mΩ] Vgs=10V	Ciss (typ) [pF]	Qg (typ) [nC]	Vth (typ) [V]	Rth(j-c) (max) [°C/W]		
MG032A4207R5A	-	-	75	420	840	500	150	-	0.98	80120	505	3.0	0.25	-	○
MG032B420010A	-	MG032	100	420	840	500	150	0.99	1.37	91800	500	3.0	0.25	-	○
MG031B090004A	-	-	40	90	360	125	175	2.34	3.20	4180	76	2.0	1.2	-	○
★ MG031E120004A	-	-	40	120	480	125	175	2.44	3.10	3540	68	3.0	1.2	-	■
★ MG031G148004A	-	-	40	148	592	154	175	1.75	2.20	5330	96	3.0	0.97	-	○
★ MG031L080006A	-	-	60	80	320	125	175	4.47	5.60	3570	65	3.0	1.2	-	■
★ MG031N110006A	-	-	60	110	440	154	175	3.0	3.8	5630	94	3.0	0.97	-	■
★ MG031MC148004A	-	MG031	40	148	592	154	175	1.75	2.20	5330	96	3.0	0.97	-	■
★ MG031MD110006A	-	-	60	110	440	154	175	3.1	3.9	5630	94	3.0	0.97	-	■
★ MG048A150004A	-	-	40	150	600	147	150	2.1	2.7	5900	111	3.0	0.85	-	■
★ MG048B100006A	-	MG048	60	100	400	147	150	2.82	3.92	8186	136	3.0	0.85	-	■

■: New product ★: Under development ■: Please contact us.

Equivalent Circuit Schematic

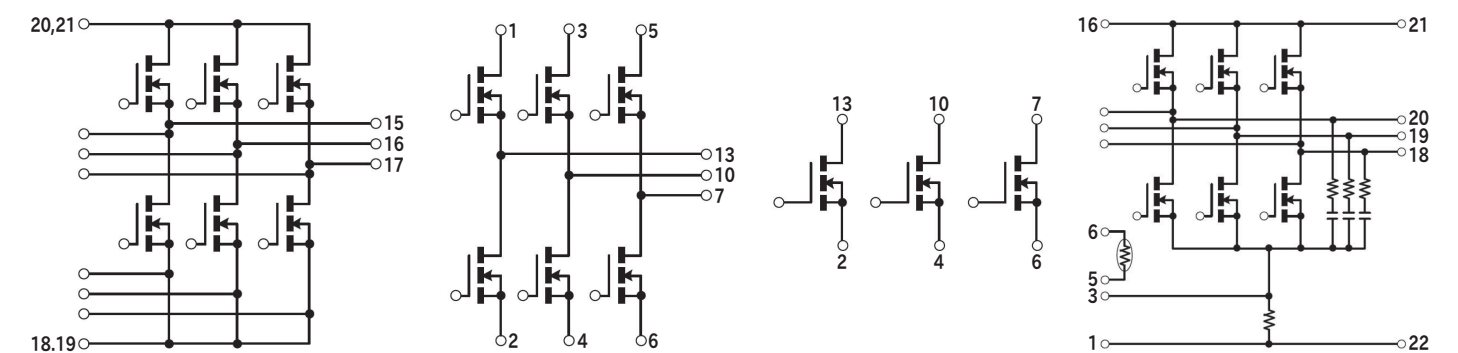

MG032

MG031

MG031

(MG031MC148004A)
(MG031MD110006A)

MG048

POWER ICs

Line up

IC for LED Lighting

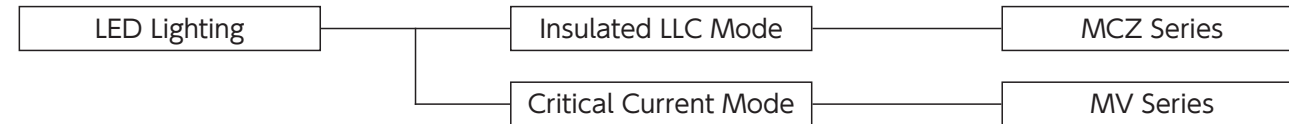

IC for Power Supply

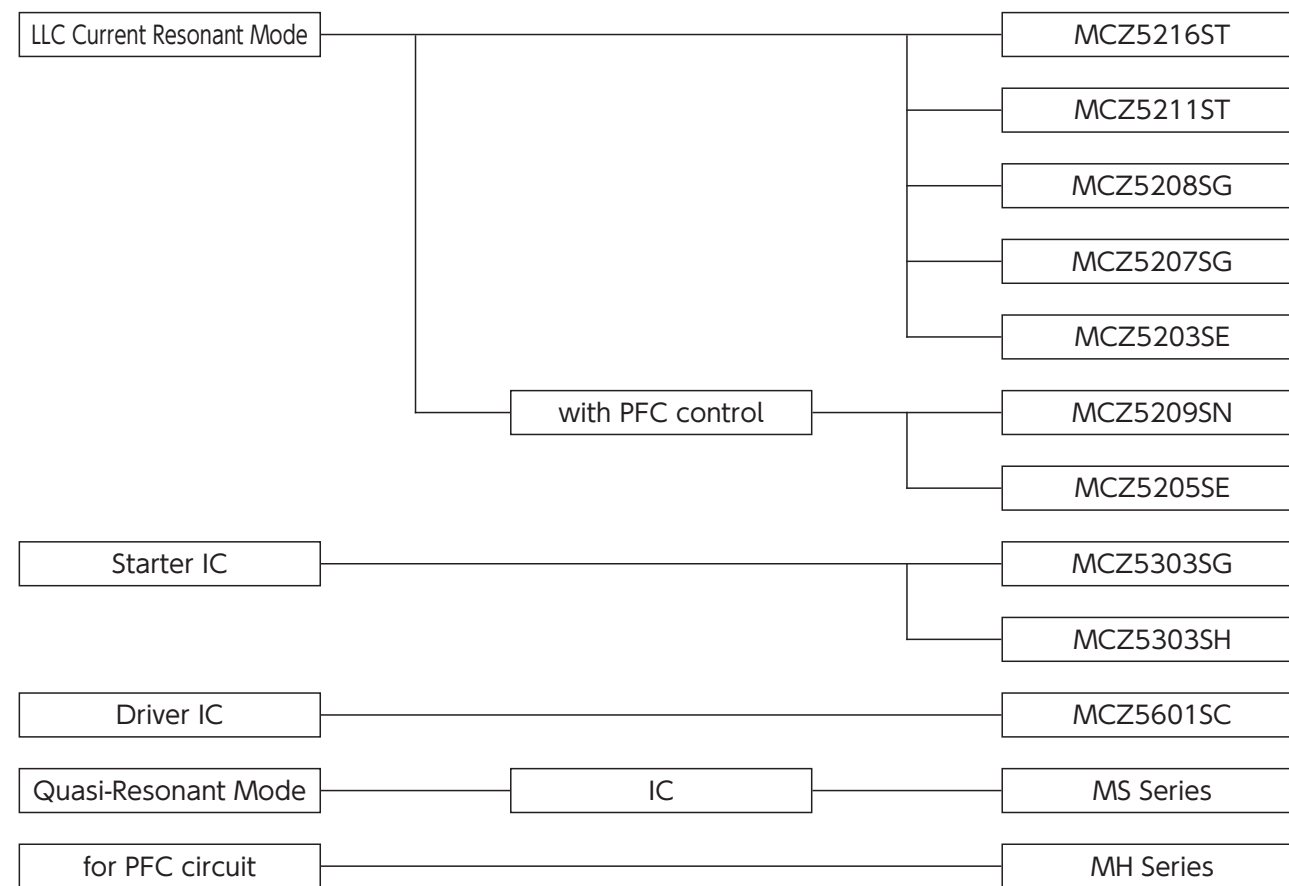



IC for LED Lighting

Critical Current Mode Power Supply ICs for LED Lighting : MV Series

- Outline The MV series has a specialized function for LED lighting with PWM & Linear dimming that operates Critical Current Mode without auxiliary winding. On and off width modulation function allows for smooth deep dimming of 1% or less.

MV Series

Critical Current Mode Power Supply ICs for LED Lighting												
Package		Type No.	HV Startup	Vcc [V]	Output	ON/OFF	Built-in Regulator Voltage [V]	Linear Dimming	PWM Dimming	Automotive		
JEDEC Code JEITA Code House Name	Fig.											
	-	SOP8J	L2	MV1001SC	Yes	9 to 16	1ch	-	-	-	-	
			MV1002SC	No								
			MV1011SC	Yes								
			MV1012SC	No								
	-	SOP16	L5	MV2002SG	No	10 to 16	2ch	Cont. by REF Voltage	3.3	Yes	Yes	-
			MV2052SG	No	5				-			

POWER ICs

IC for Power Supply

LLC Current Resonant Mode Controller ICs for Bridge Converter : MCZ Series

Outline The MCZ series is an advanced symmetric LLC current resonant mode controller for bridge converters. Symmetric LLC resonant converter applications are greatly expanding due to their extremely high efficiency and low noise characteristics.

Starter ICs with Built-in Burst Function : MCZ5303

Outline A dedicated IC that provides a low power consumption start-up for circuits without an IC. Low power consumption standby is possible due to the ON/OFF Control IC with burst function. It is especially effective when used in conjunction with the LLC current resonance power supply.

High/Low Side Driving IC

Outline A driving IC for MOSFET and IGBT power devices. With built-in high-withstand voltage components, it can be used for a variety of uses such as inverter and power supply, etc.





Low Power Standby Quasi-Resonant Power Supply ICs : MS Series

Outline The MS series consumes much less power in standby mode than conventional MR series. The ICs incorporate various functions to make it more user-friendly and easier to design a power supply with fewer external components.

PFC ICs : MH Series



Outline The MH series is a PFC circuit control IC which enables multistage interleave. An efficient, high power operation is possible by utilizing a slave IC composed of multistage interleave and a master IC that can be used alone.

MCZ Series

LLC Current Resonant Mode Controller ICs for Bridge Converter																											
Package		Fig.	Type No.	Type	HV Startup	High-side Drive	Vcc (max) [V]	Vin Sensing	Burst Mode	Maximum Frequency [kHz]	X-cap. discharge	Capacitive Mode Protection	Over Voltage Protection	Over Current Protection	Automotive												
JEDEC Code	JEITA Code															House Name											
	-	L6	MCZ5216ST	LLC Current Resonant Mode	Yes	Yes	35	Yes	Yes	500	Yes	Yes	Latch	Timer Latch	-												
	-		MCZ5211ST	LLC Current Resonant Mode	Yes				Yes	500	No				-												
	-	L8	MCZ5209SN	LLC Current Resonant Mode with PFC Control	Yes				Yes	35	Yes				Yes	300	No	Yes	Latch	Timer Latch	-						
	-		SOP24																								
	-	L5	MCZ5207SG	LLC Current Resonant Mode	No										Yes	35	Yes				Yes	300	No	Yes	Latch	Timer Latch	-
	-		SOP16	MCZ5208SG	LLC Current Resonant Mode																No	Yes	500				No
	-	L7	MCZ5205SE	LLC Current Resonant Mode with PFC Control	No	Yes	35	Yes				No	300	No							Yes	Latch	Timer Latch				-
	-		SOP22																								
	-	L7	MCZ5203SE	LLC Current Resonant Mode	No				Yes	35	Yes	No	300	No				Yes	Latch	Timer Latch							-
	-		SOP22																								

 : New product

Starter ICs with Built-in Burst Function

Package		Fig.	Type No.	Vin Applied Voltage [V]	Vcc Output Voltage [V]	HV Startup	Vin Sensing	Burst Mode	Automotive
JEDEC Code	JEITA Code								
	-	L5	MCZ5303SG	95 to 450	18.5(typ)	Yes	Yes	Yes	-
	-		SOP16						
	-	L3	MCZ5303SH	95 to 450	18.5(typ)	Yes	No	No	-
	-		SOP8/7J						



High/Low Side Driver ICs

Package		Fig.	Type No.	Output	High-side Floating Supply Voltage [V]	Vcc (max) [V]	Input/Output Channel	Vcc_UVLO [V]	VBS_UVLO [V]	Typ. Output Current		Automotive
JEDEC Code	JEITA Code									House Name	Source [mA]	
	-	L2	MCZ5601SC	High-side/Low-side	600	22	2/2	8.2 to 9.0	7.2 to 8.0	400	400	-
	-		SOP8J									

 : New product

MS Series

Low Power Standby Quasi-Resonant Power Supply ICs

Package		Fig.	Type No.	Vin [V]	Vcc [V]	Over Voltage Protection	Over Current Protection	Stand-by Operation	Bottom Skip	Automotive
JEDEC Code	JEITA Code									
	-	L3	★ MS1007SH	95 to 450	11 to 21	Auto restart	Auto restart	Auto Burst Mode	1 skip	-
	-		MS1004SH		11 to 24	Vcc Latch	Timer Latch 2sec. (typ)	Auto Burst Mode/S-Stby Mode	2 skip	-
	-		MS1003SH					1 skip	-	
	-	L4	MS1006SK	95 to 450	11 to 24	Vcc Latch	Timer Latch 2sec. (typ)	Auto Burst Mode/UT-Stby Mode	2 skip	-
	-		SOP14					MS1005SK	1 skip	-









★ : Under development

MH Series

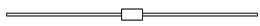
PFC ICs

Package		Fig.	Type No.	Type	Operation Mode	Vin Sensing	Vcc [V]	Zero Current Detection	Diodes Short Protection	FB Open Short Protection	Over Voltage Protection	Automotive
JEDEC Code	JEITA Code											
	-	L2	MH2501SC	Critical Current Mode	Master	Unnecessary	13 to 23	Auxiliary Winding	Yes	Yes	Yes	-
	-		SOP8J	MH2511SC	Synchronizes with Master IC		Slave	11 to 23	-	No	No	No

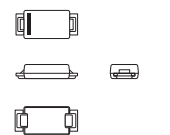
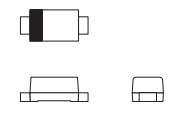
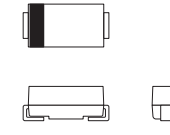
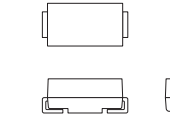
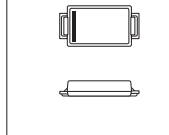
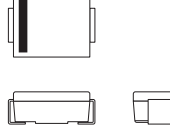
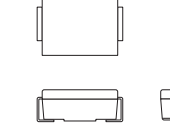
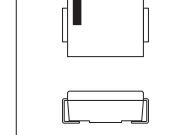
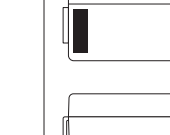
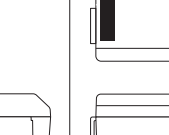
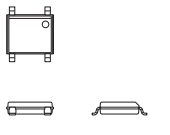
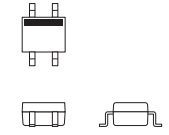
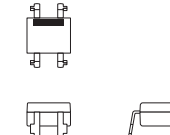
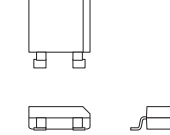
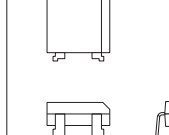
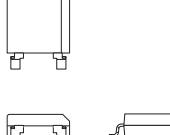
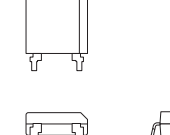
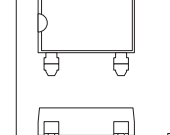
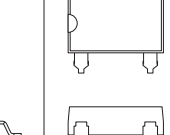
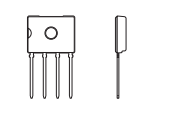
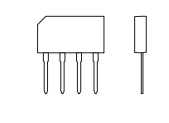
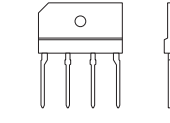
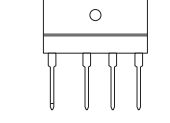
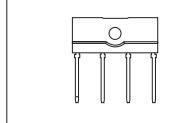
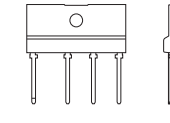
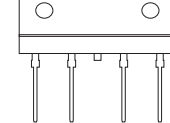
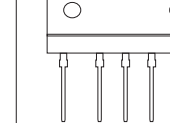
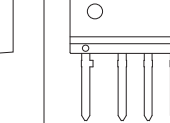
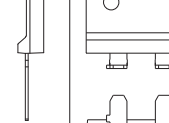
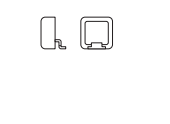
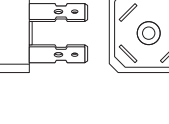
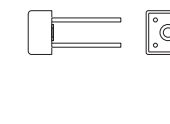
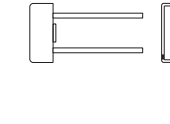
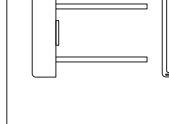
PACKAGE LIST

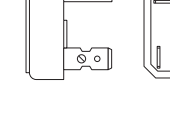
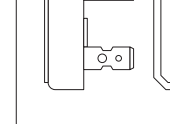
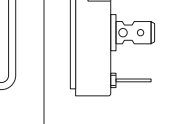
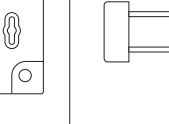
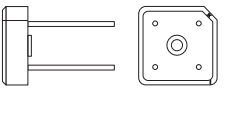
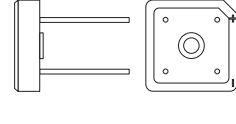
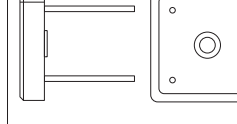
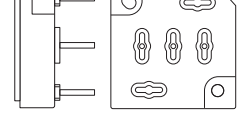
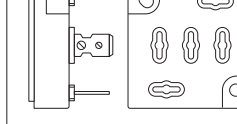
	1	2	3	4	5		6	7	8	9	10
A	A1 Package:AX057 	A2 Package:AX06 	A3 Package:AX06 	A4 Package:AX078 	A5 Package:AX10 		A6 Package:AX10 	A7 Package:AX14 			
B	B1 Package:DO-219AB similar G1E 	B2 Package:DO-219AA M1E 	B3 Package:DO-214AC 1E 	B4 Package:DO-214AC 1E 	B5 Package:SC-110B CE 		B6 Package:DO-214AA similar M2E 	B7 Package:DO-214AA similar M2E 	B8 Package:DO-214AA similar M2E 	B9 Package:2F 	B10 Package:2F 
C	C1 Package:SOPA-4 	C2 Package:TO-269AA 1Z(GSMO) 	C3 Package:1Z(DIP) 	C4 Package:1N(SMD) 	C5 Package:1N(DIP) 		C6 Package:1NA(SMD) 	C7 Package:1NA(DIP) 	C8 Package:1W(SMD) 	C9 Package:1W(DIP) 	
D	D1 Package:D3K 	D2 Package:2S 	D3 Package:3S 	D4 Package:5S 	D5 Package:JB 		D6 Package:JA 	D7 Package:TSB(4pin),JC(4pin) 	D8 Package:TSB(5pin),JC(5pin) 	D9 Package:JF 	D10 Package:JH 
E	E1 Package:MCP 	E2 Package:D30VC 	E3 Package:S2VB 	E4 Package:S4VB 	E5 Package:S5VB 		E6 Package:S10VB 	E7 Package:S15VB 	E8 Package:S25VB 	E9 Package:S50VB 	E10 Package:S3WB 
	11	12	13	14	15						
E	E11 Package:S10WB 	E12 Package:S15WB 	E13 Package:S20WB 	E14 Package:SVTA 	E15 Package:SVT 						

PACKAGE LIST

PACKAGE LIST

	1	2	3	4	5		6	7	8	9	10
F	F1 Package:Module 	F2 Package:Module 	F3 Package:Module 	F4 Package:MG001 	F5 Package:MG031 		F6 Package:MG032 	F7 Package:MG038 	F8 Package:MG048 		
G	G1 Package:SC-63 E-pack 	G2 Package:TO-252AA EB 	G3 Package:TO-252AB similar EB 	G4 Package:DO-277A similar EX 	G5 Package:TO-252AA similar EB 		G6 Package:LA 	G7 Package:MO-235B similar LE 			
H	H1 Package:SC-83 similar STQ-220 	H2 Package:SC-83 similar EB 	H3 Package:TO-263AB-1 EB 	H4 Package:TO-263AB ES 	H5 Package:SC-83 similar EB 		H6 Package:TO-263AB EZ 	H7 Package:TO-263-SC EZ-2L 			
J	J1 Package:SC-91A ETO-220(2pin) 	J2 Package:SC-91 ETO-220A(2pin) 	J3 Package:SC-91 ETO-220AG(2pin) 	J4 Package:SC-91 ETO-220G(2pin) 	J5 Package:TO-220AB EA 		J6 Package:SC-91A ETO-220(3pin) 	J7 Package:SC-91 ETO-220A(3pin) 	J8 Package:SC-91 ETO-220AG(3pin) 	J9 Package:SC-91 ETO-220G(3pin) 	
K	K1 Package:SC-93 ITO-3P(2pin) 	K2 Package:TO-247AD MTO-3P(2pin) 	K3 Package:SC-93 ITO-3P(3pin) 	K4 Package:TO-247AD MTO-3P(3pin) 	K5 Package:TO-247AD MTO-3P(3pin) 		K6 Package:TO-247AD MTO-3PV 	K7 Package:TO-247AD MTO-3PV 			
L	L1 Package:SOP8 	L2 Package:SOP8J 	L3 Package:SOP8/7J 	L4 Package:SOP14 	L5 Package:SOP16 		L6 Package:SOP18 	L7 Package:SOP22 	L8 Package:SOP24 		

OUTLINE DIMENSIONS

[Unit:mm]

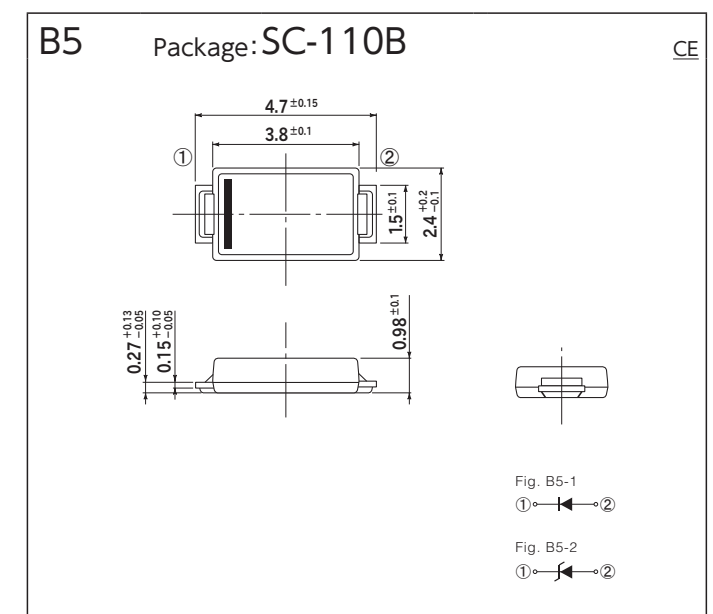
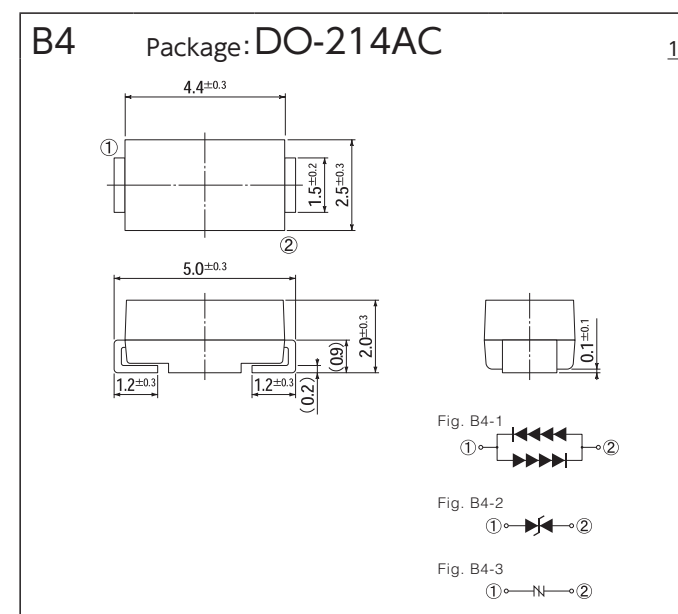
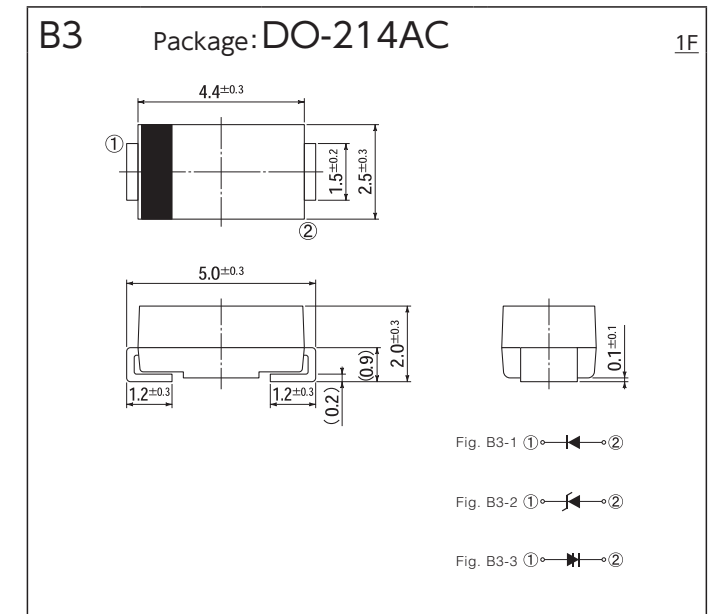
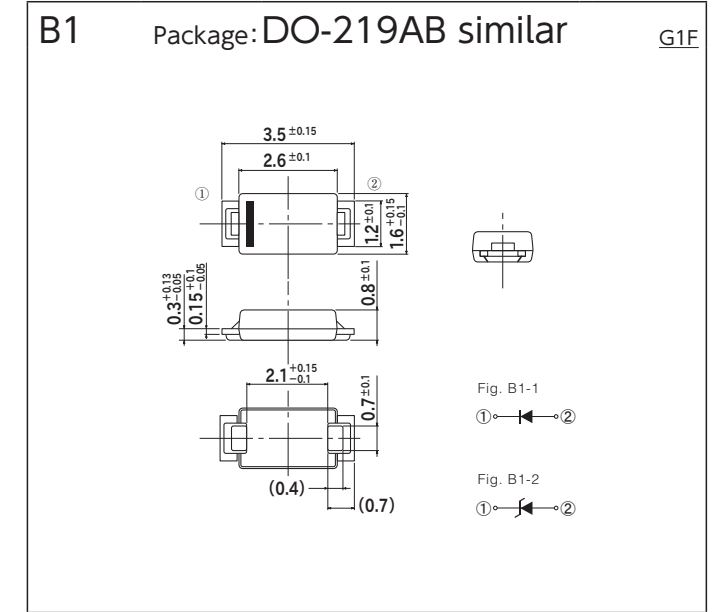
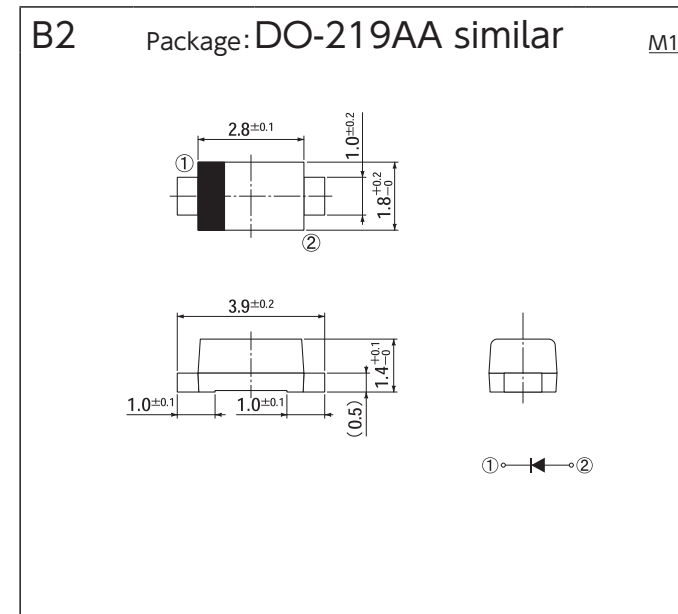
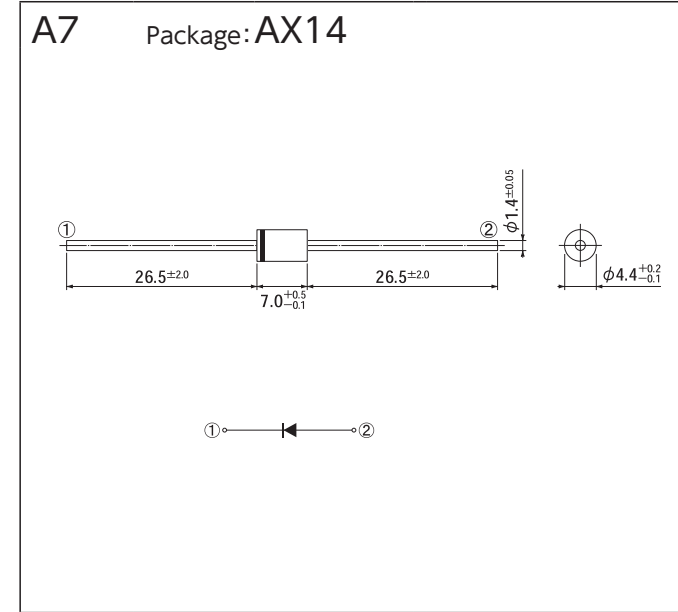
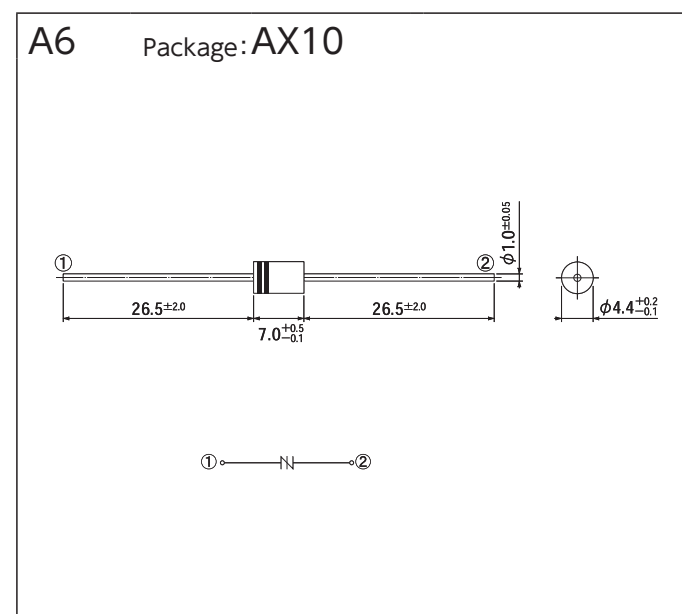
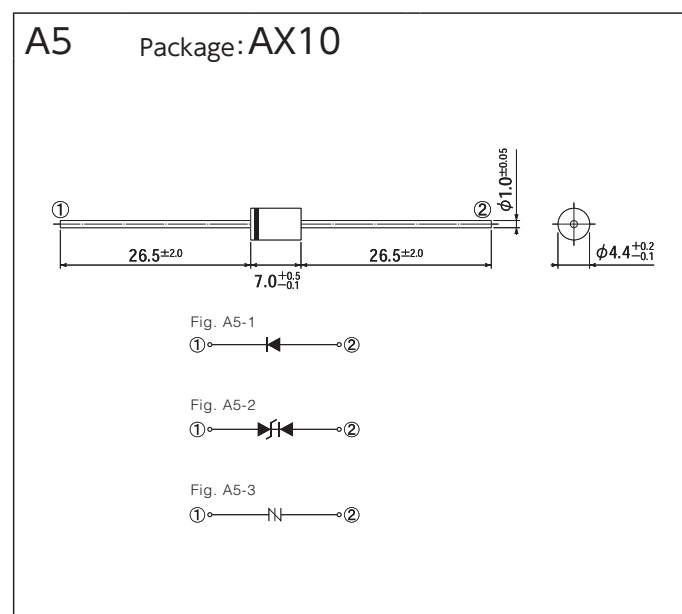
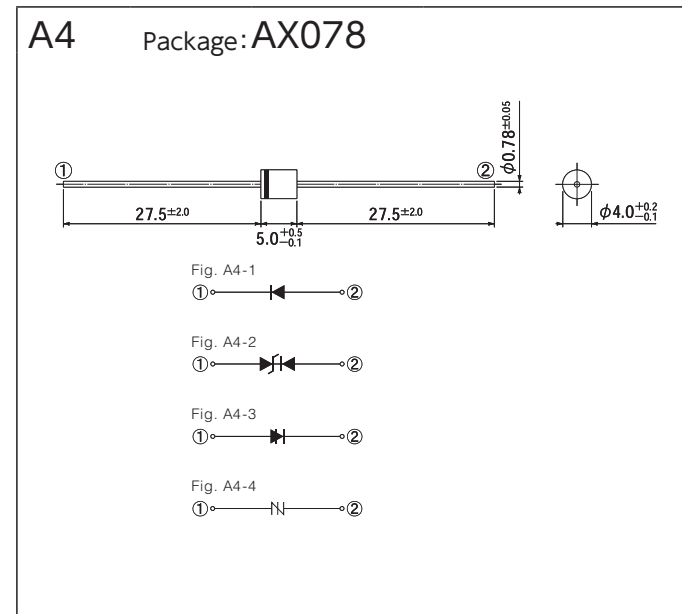
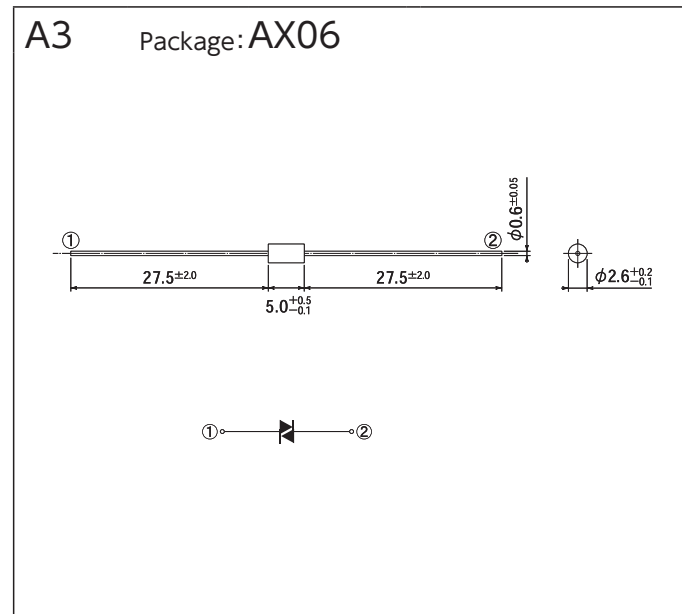
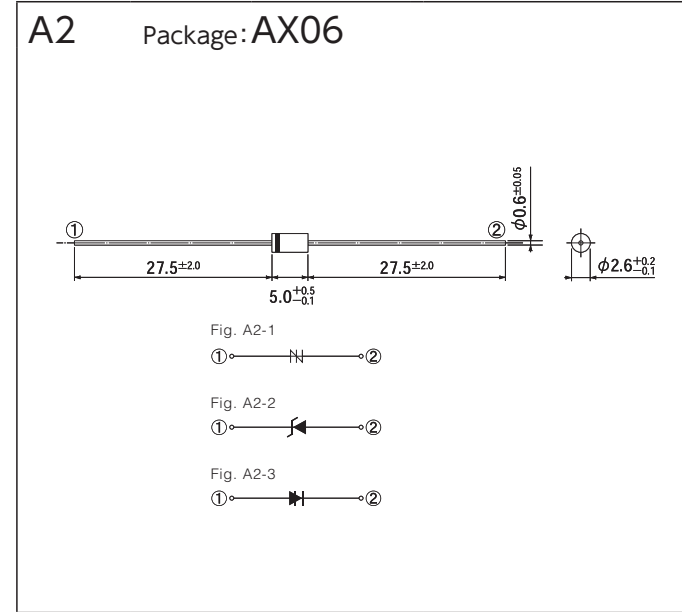
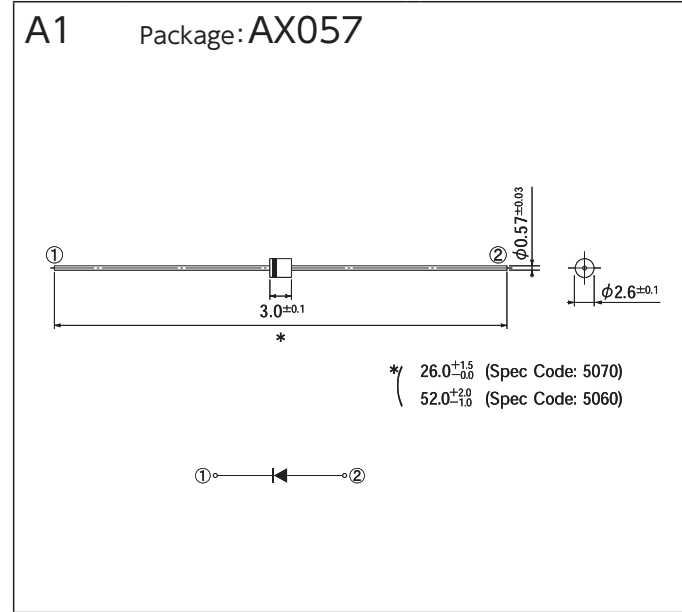

OUTLINE DIMENSIONS

[Unit:mm]

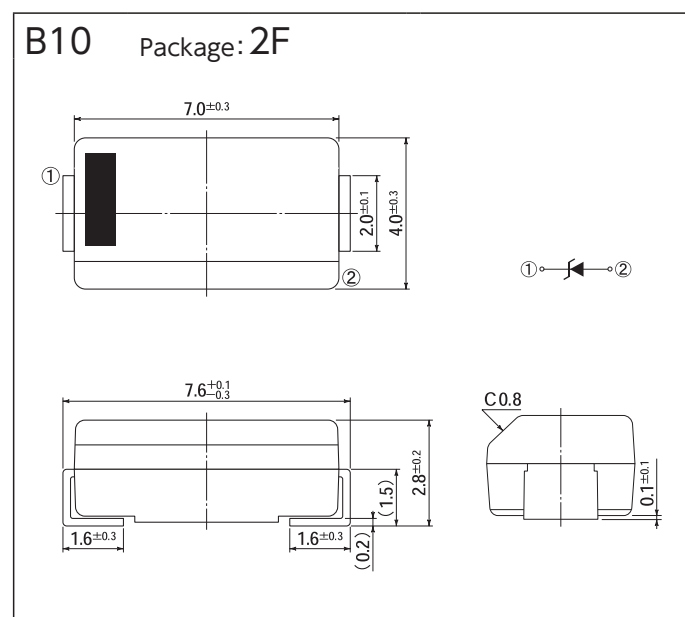
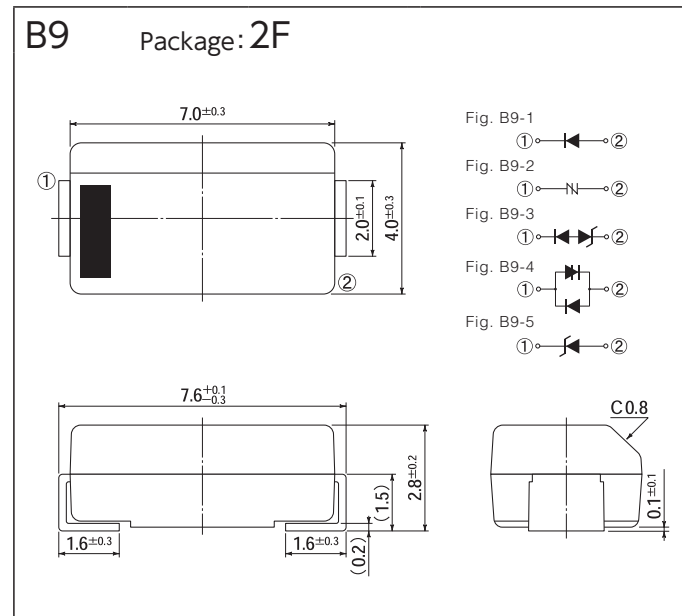
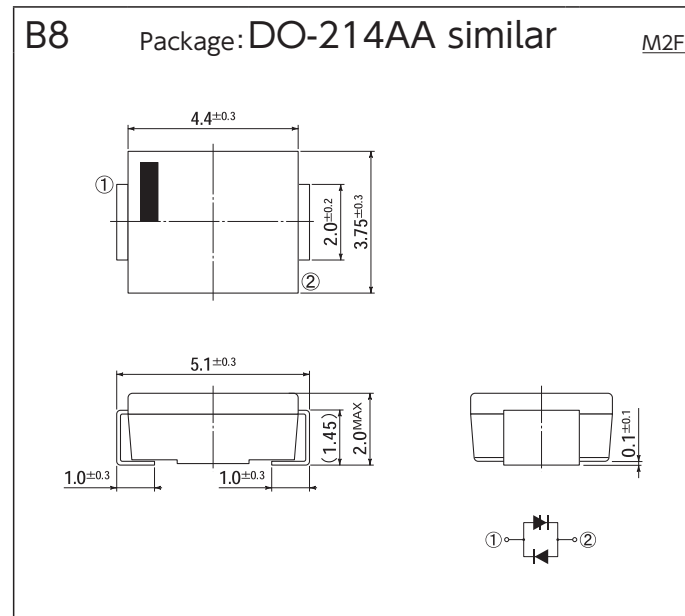
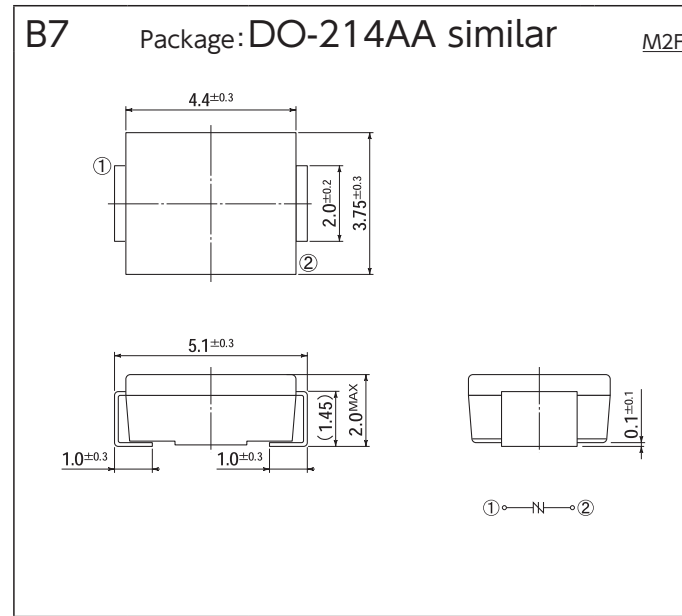
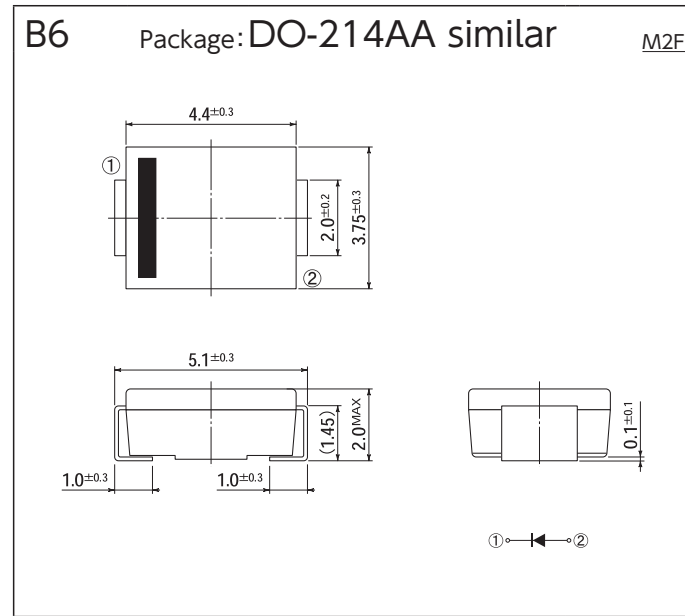

[Unit:mm]

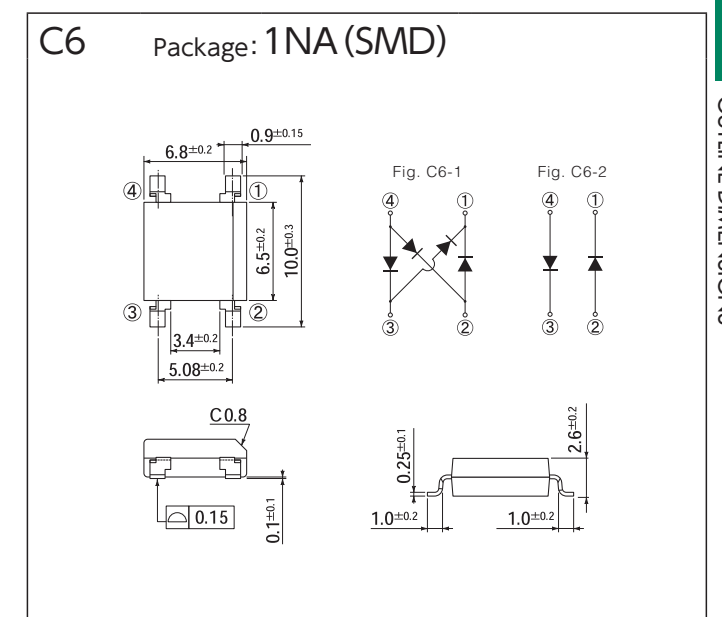
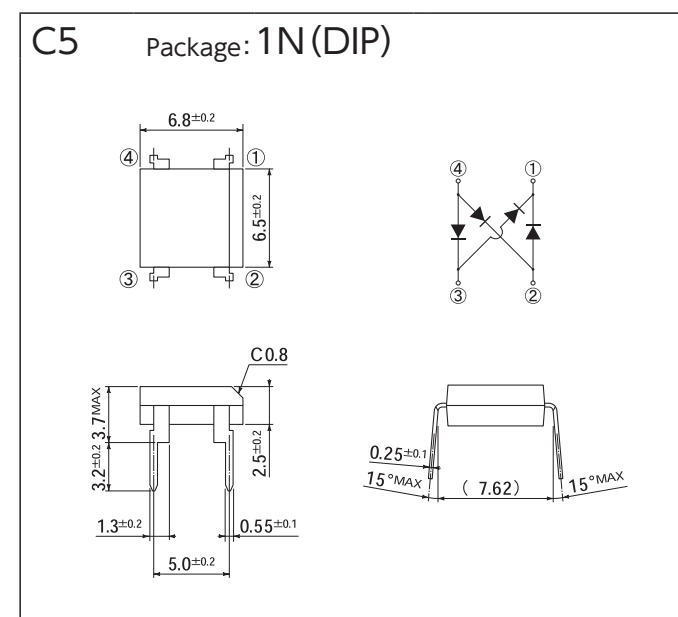
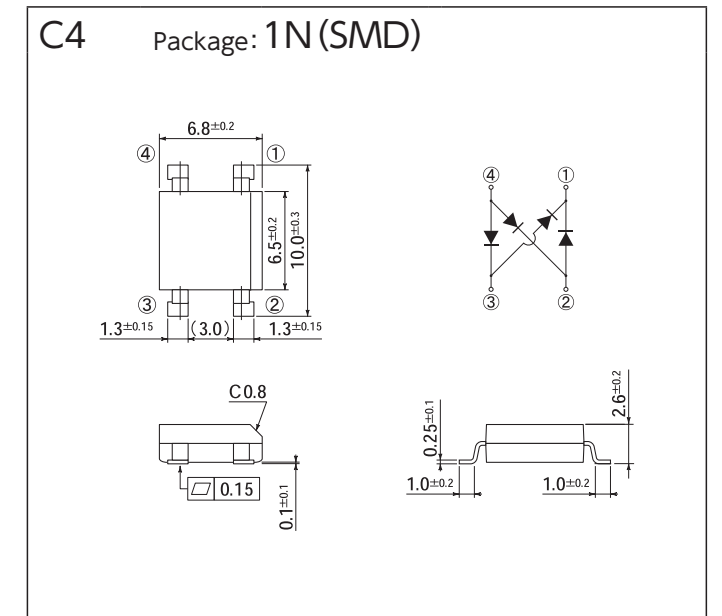
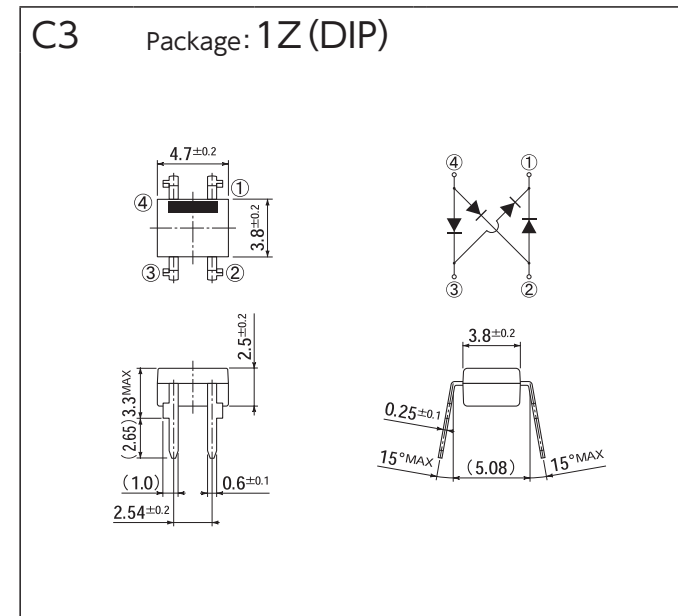
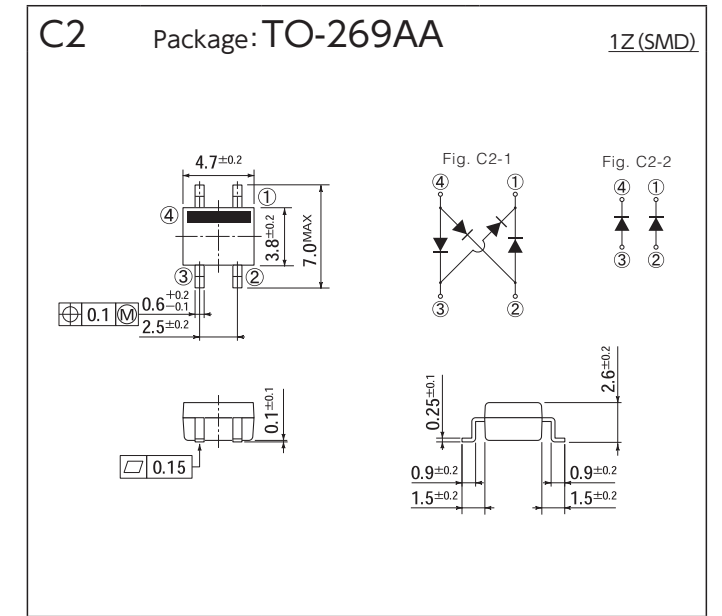
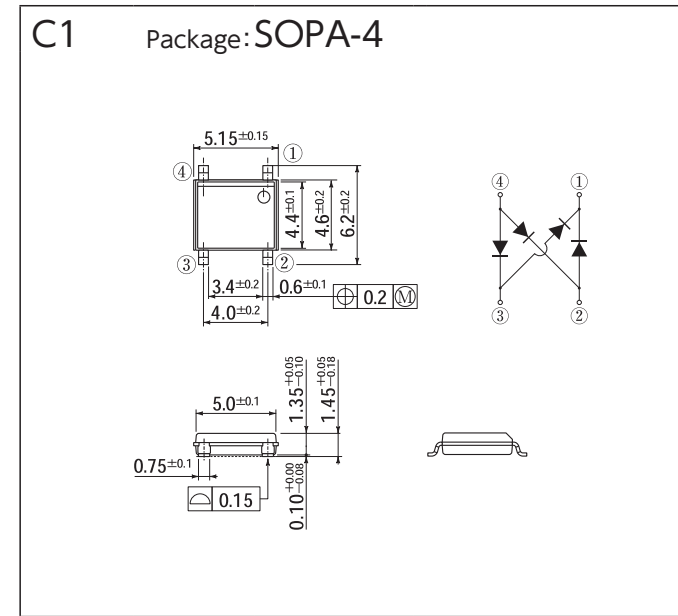

OUTLINE DIMENSIONS

[Unit:mm]

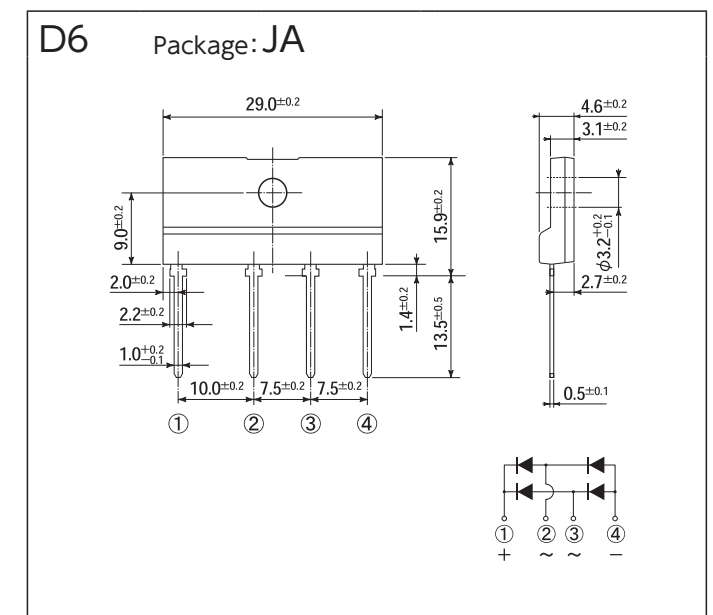
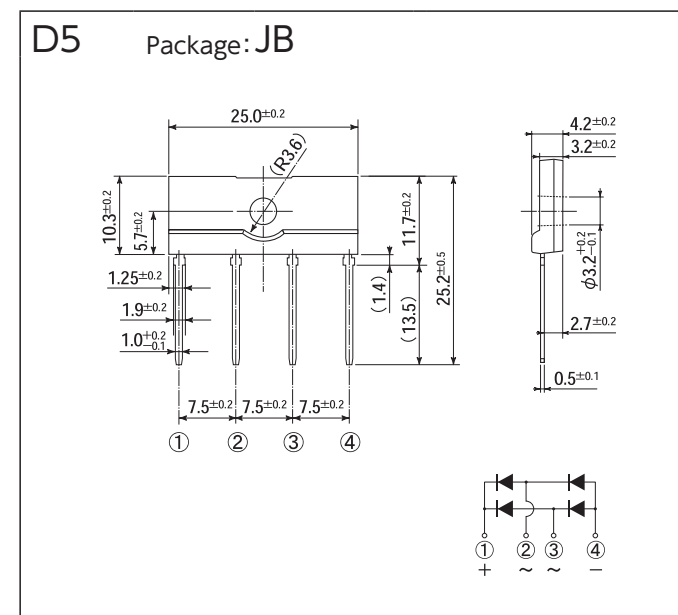
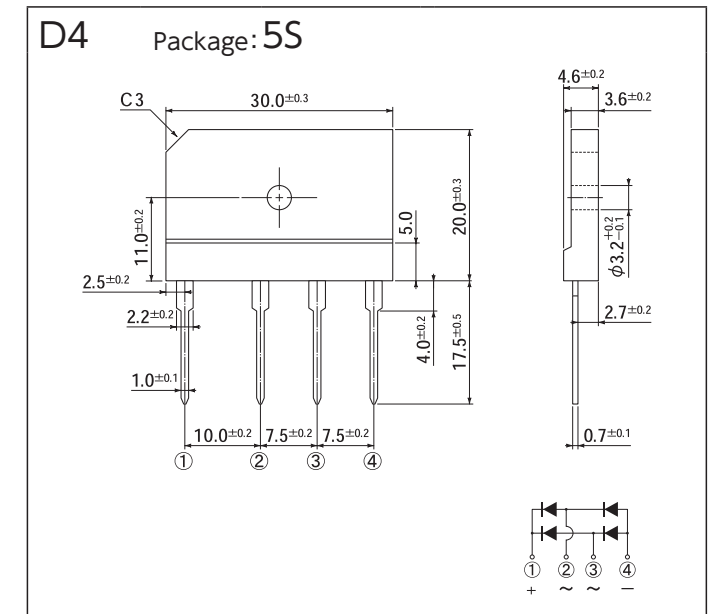
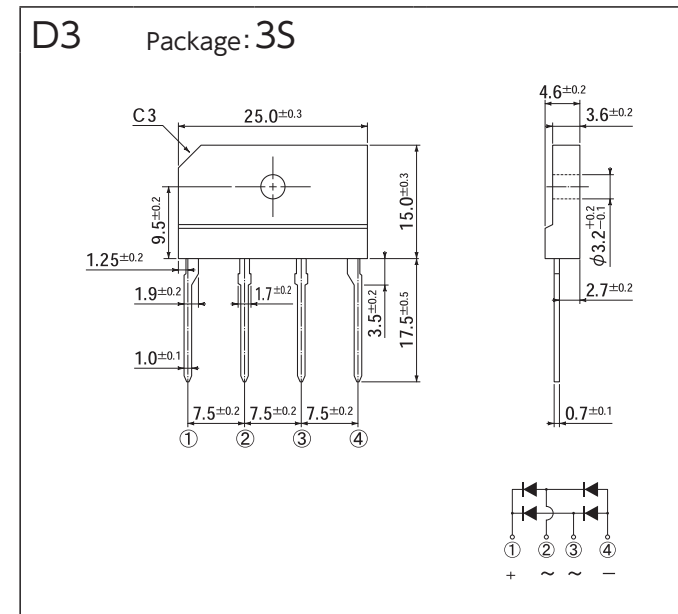
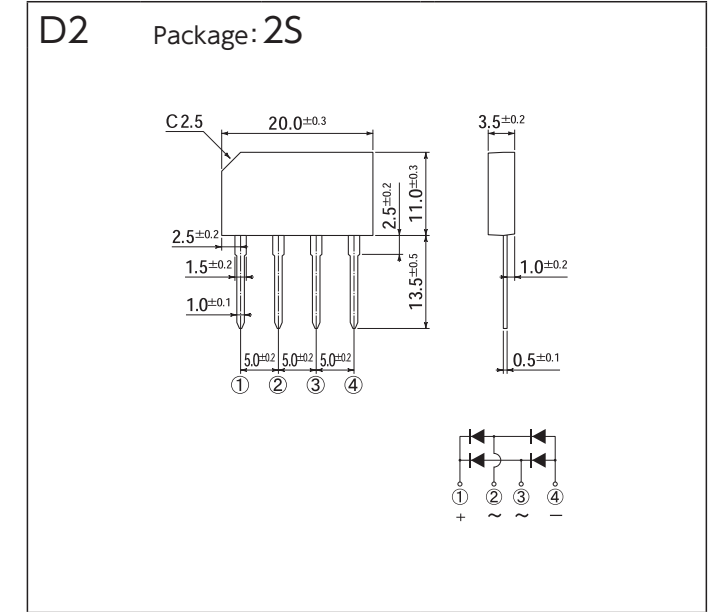
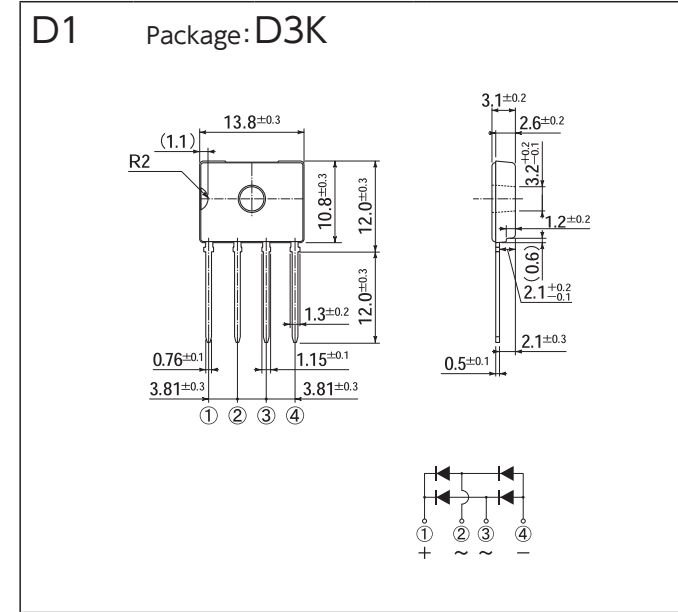
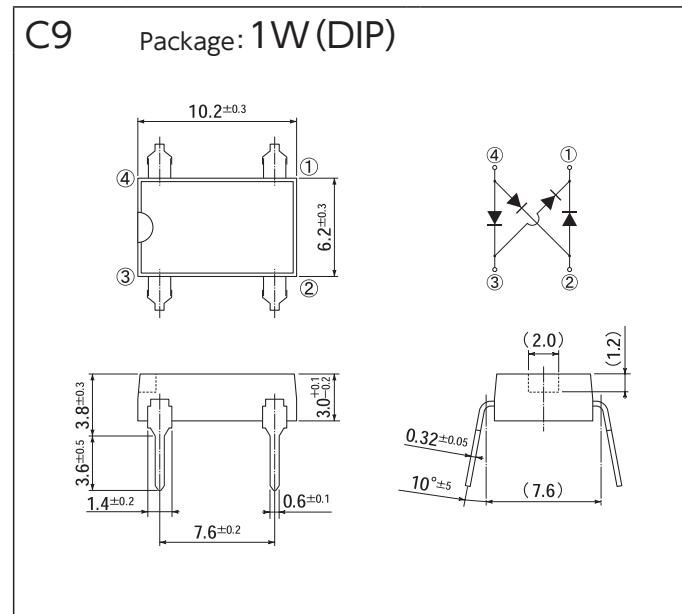
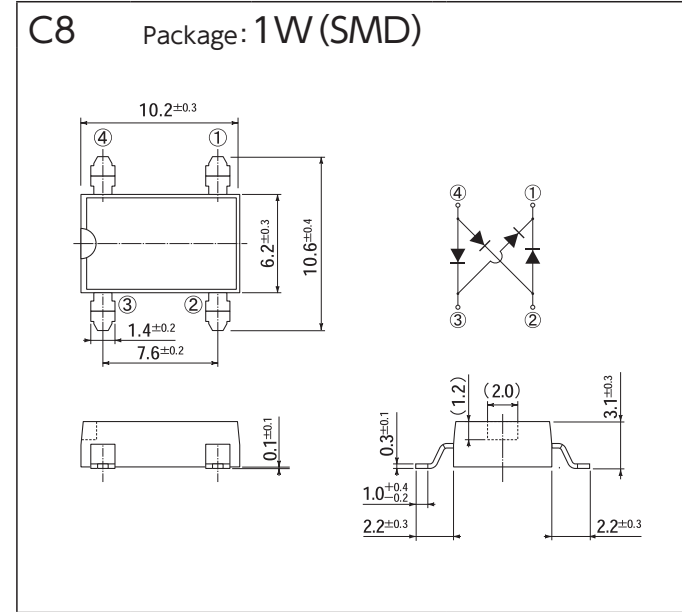
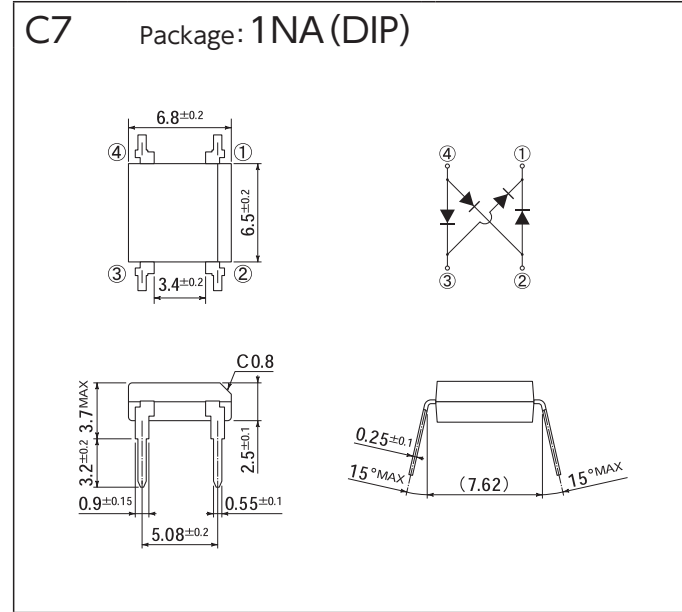

OUTLINE DIMENSIONS

[Unit:mm]

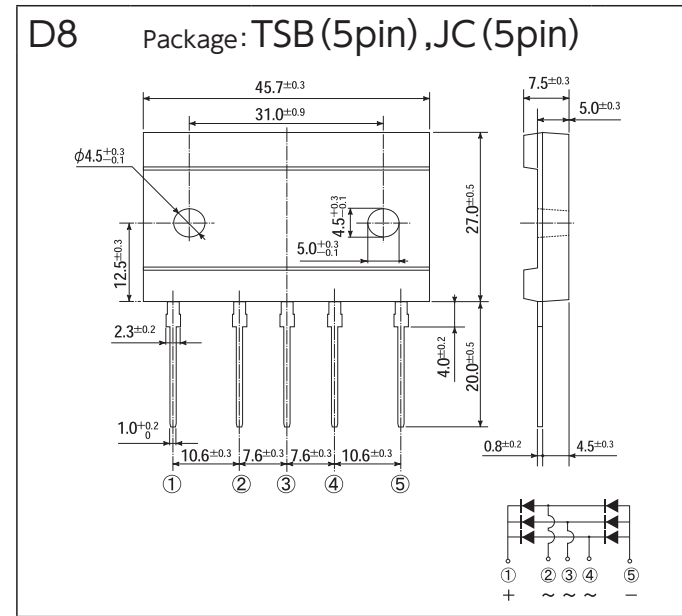
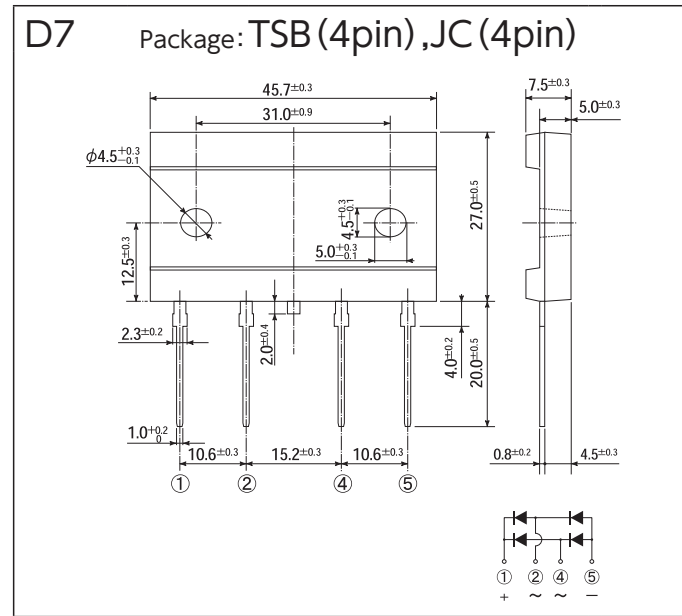

[Unit:mm]

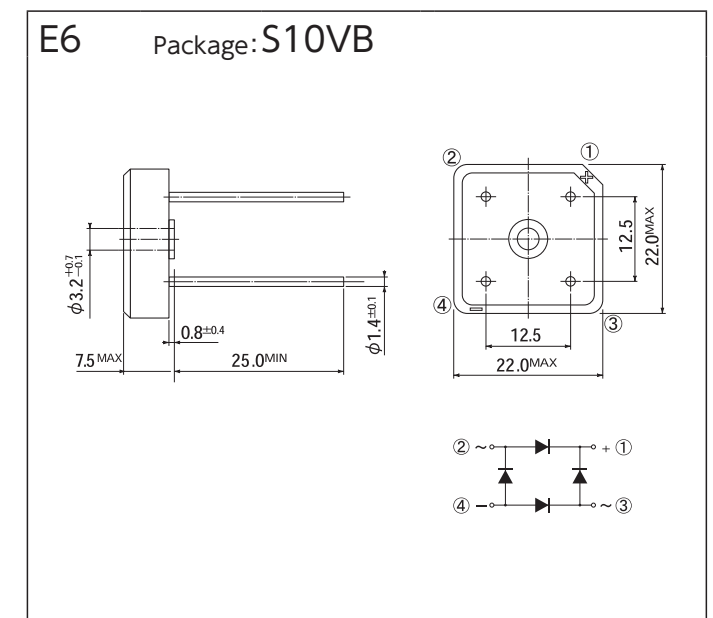
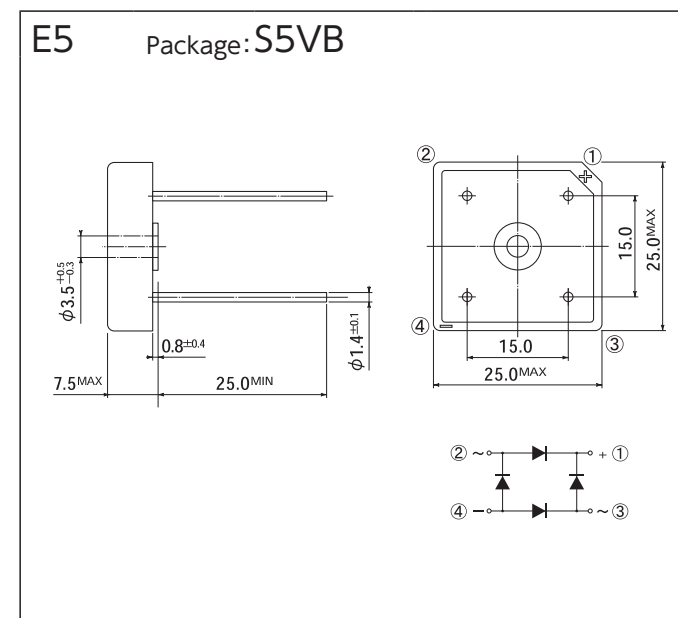
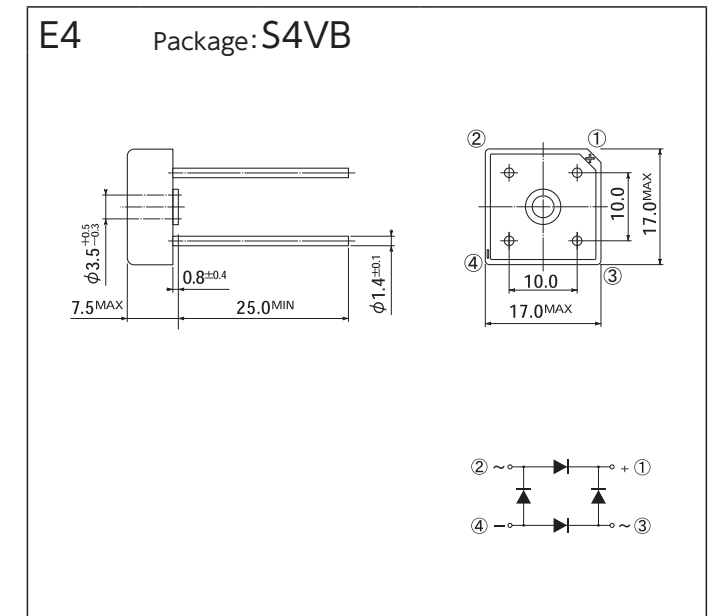
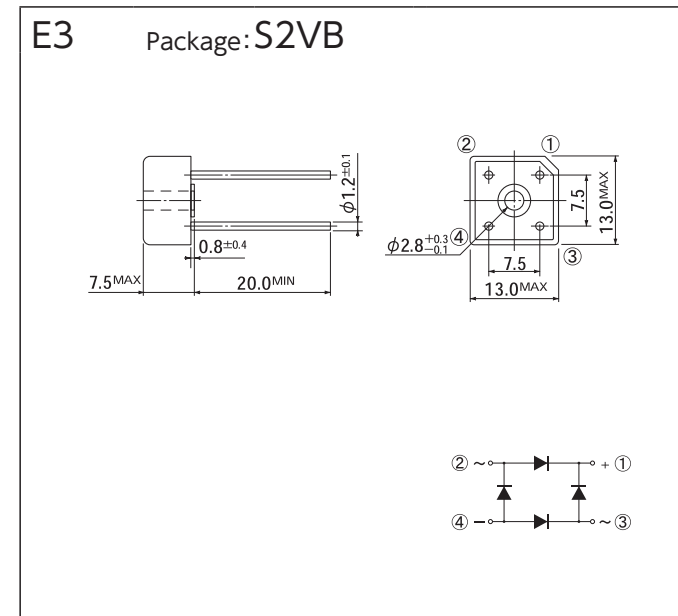
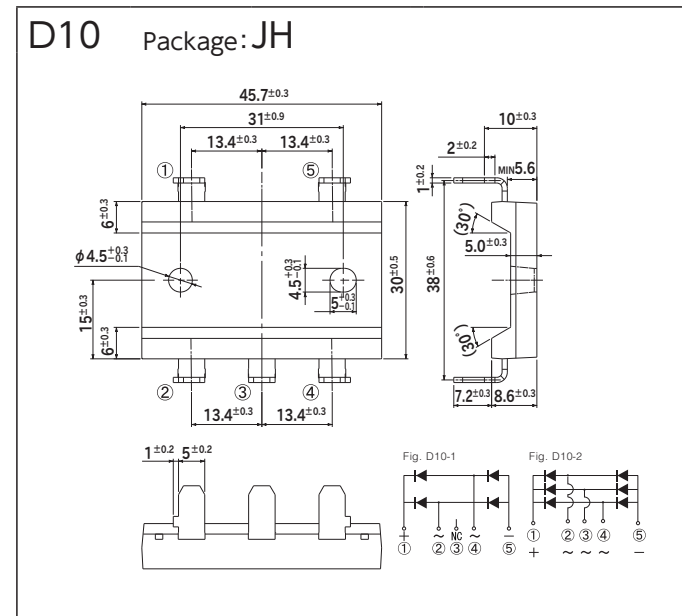
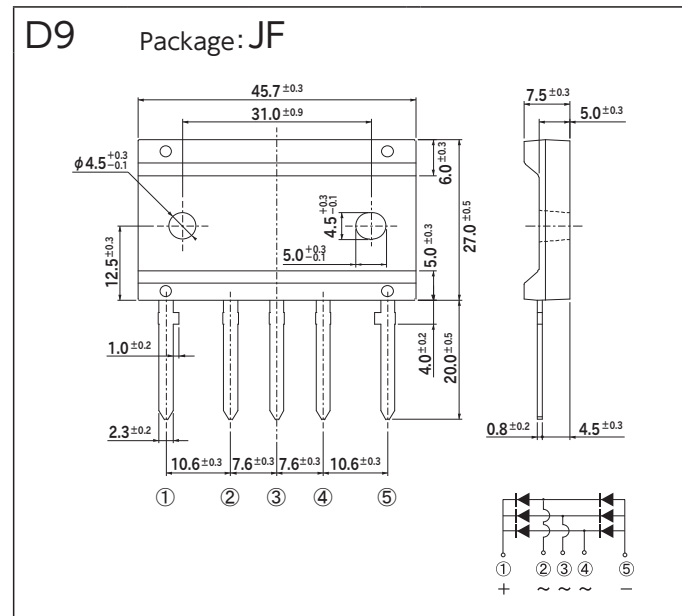
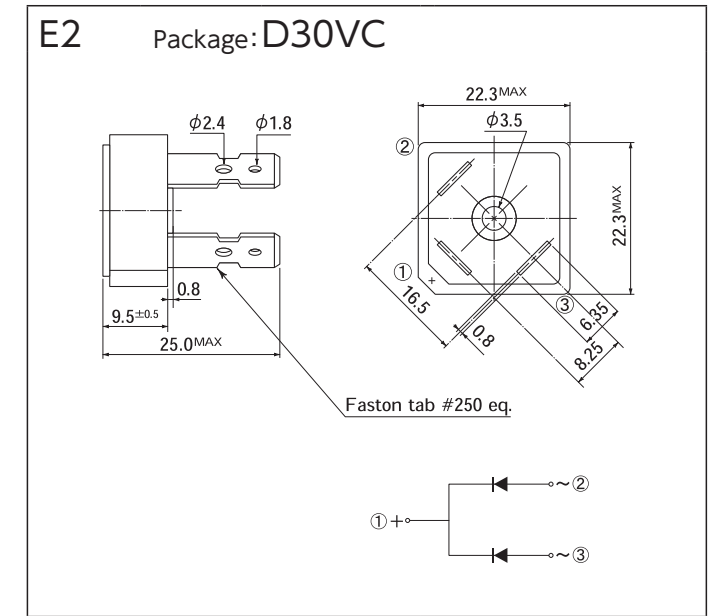
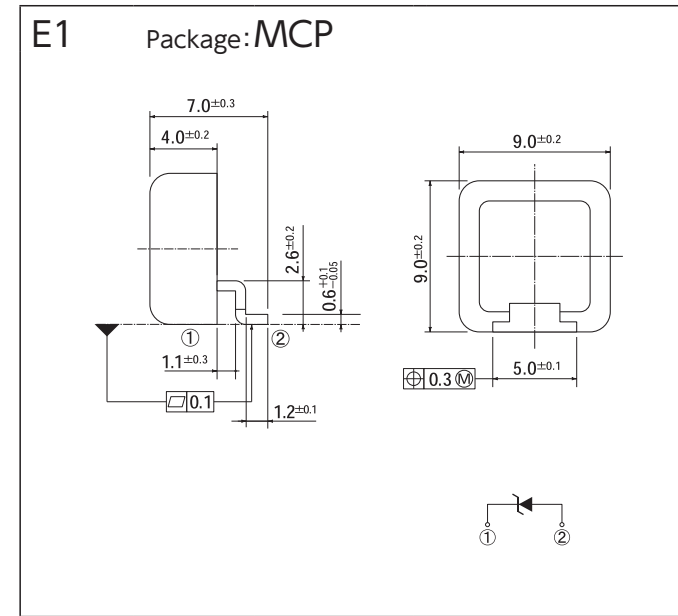

OUTLINE DIMENSIONS

[Unit:mm]

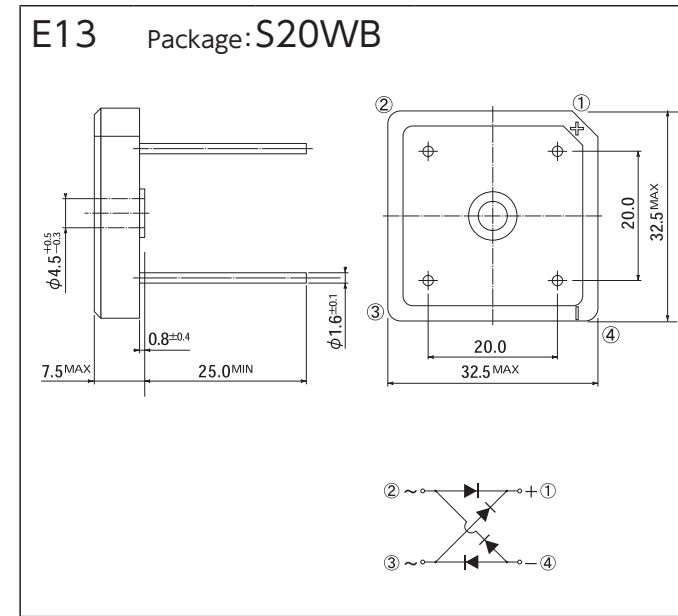
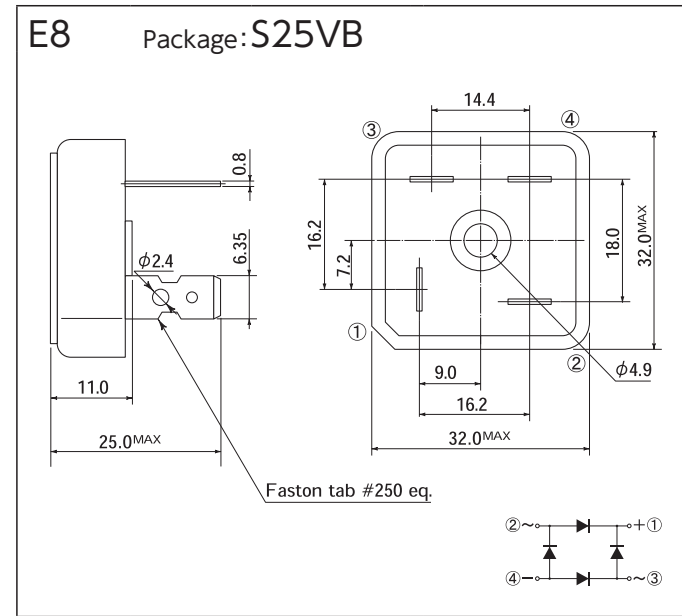
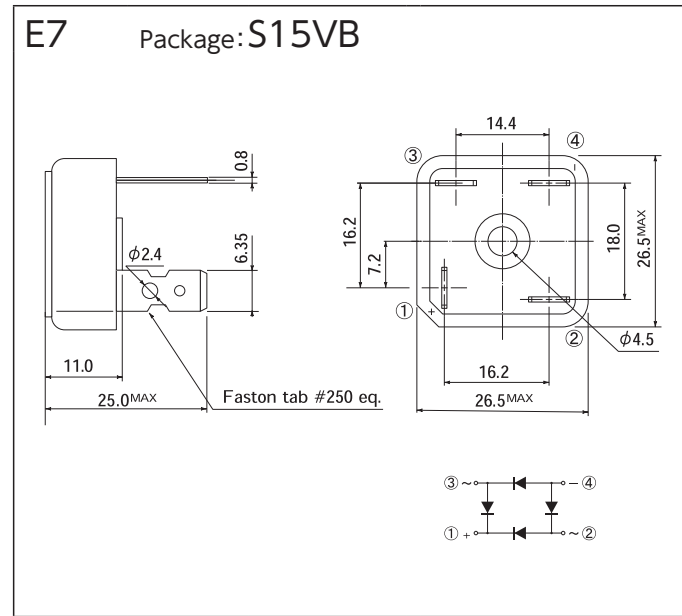

[Unit:mm]

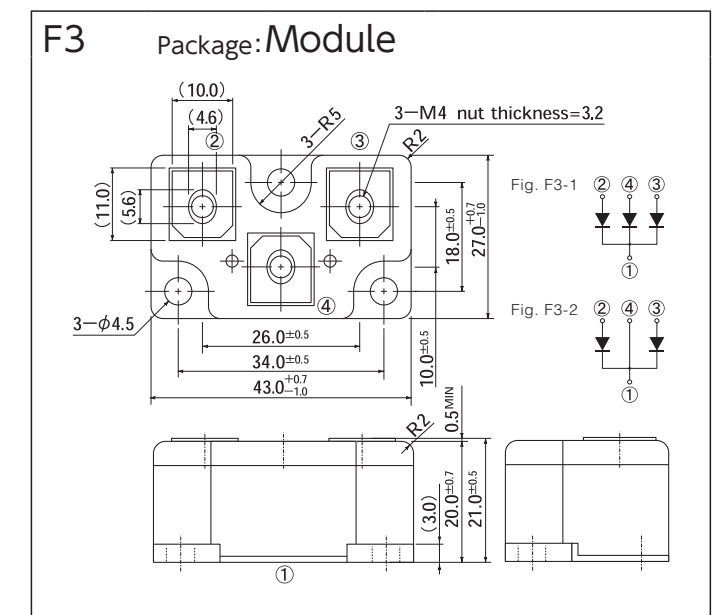
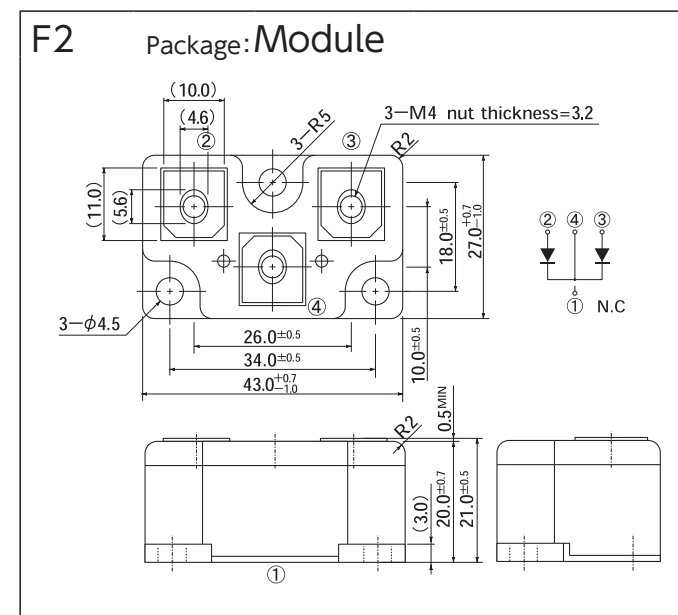
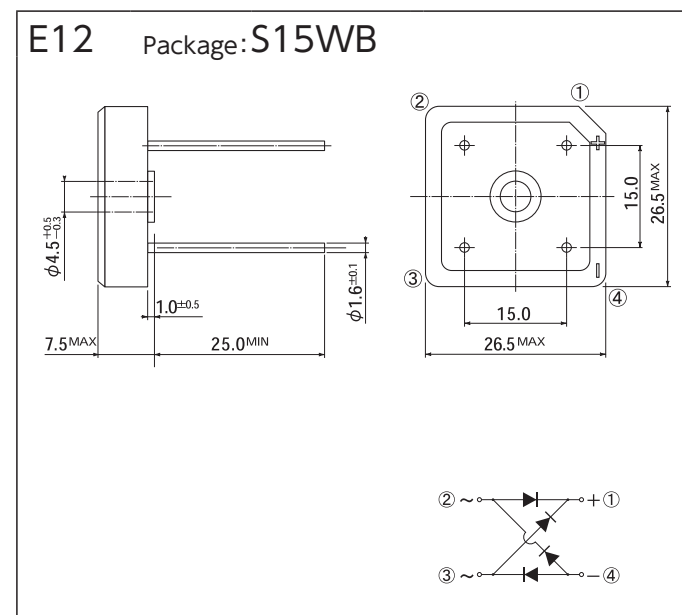
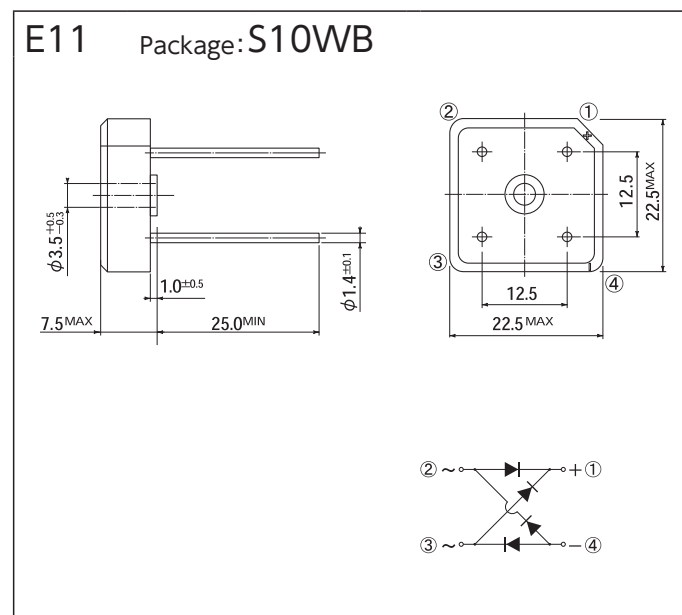
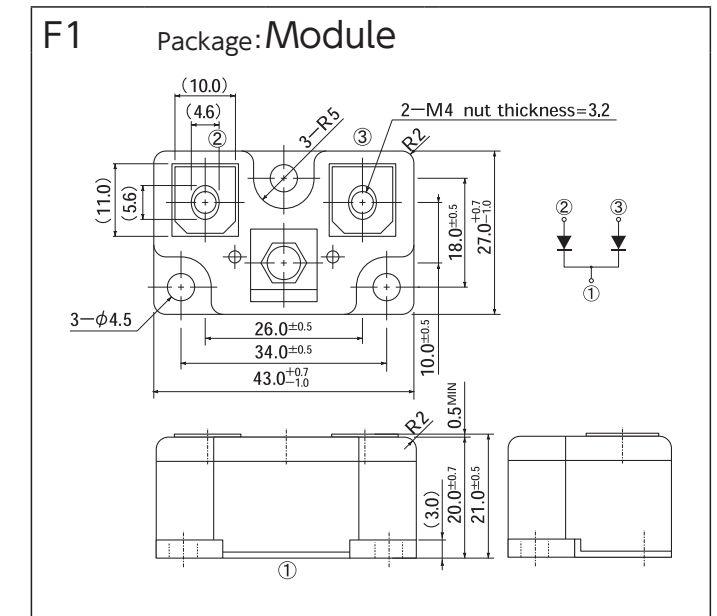
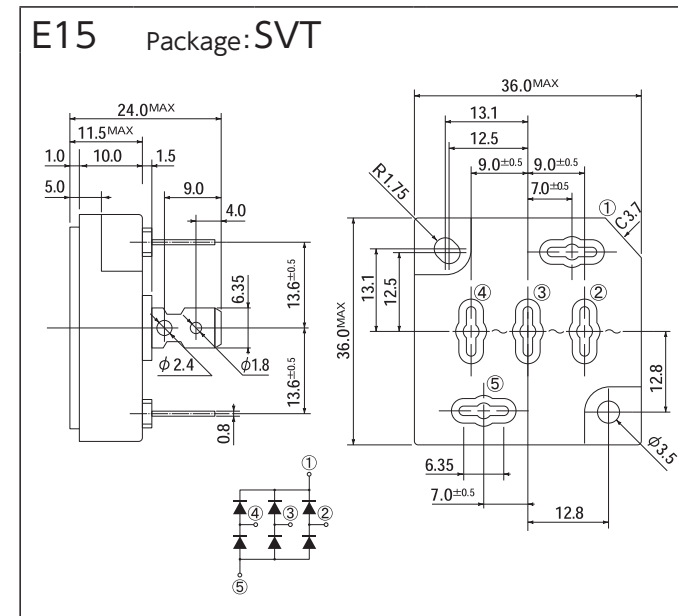
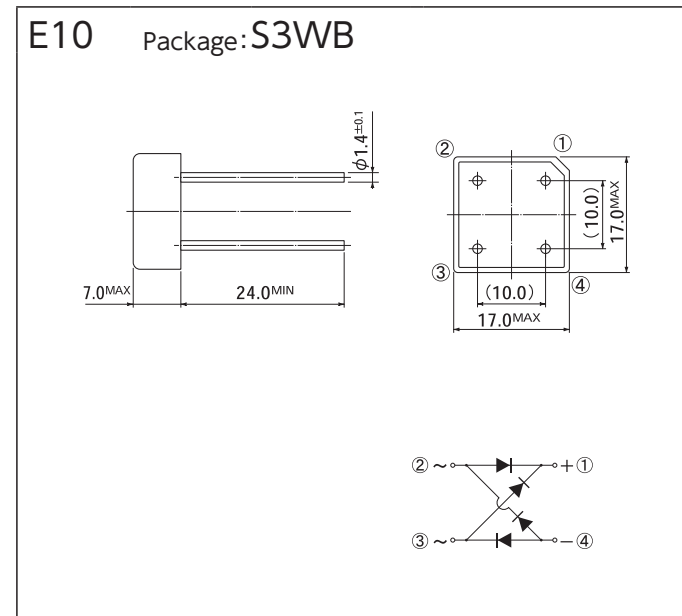
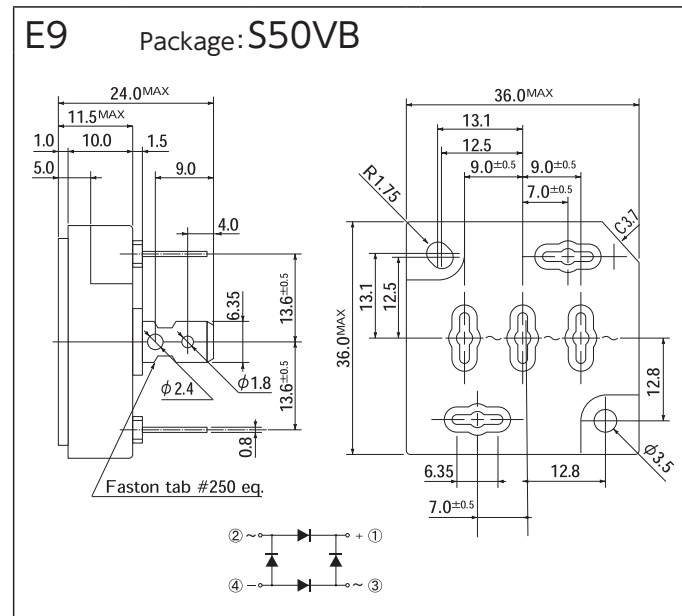
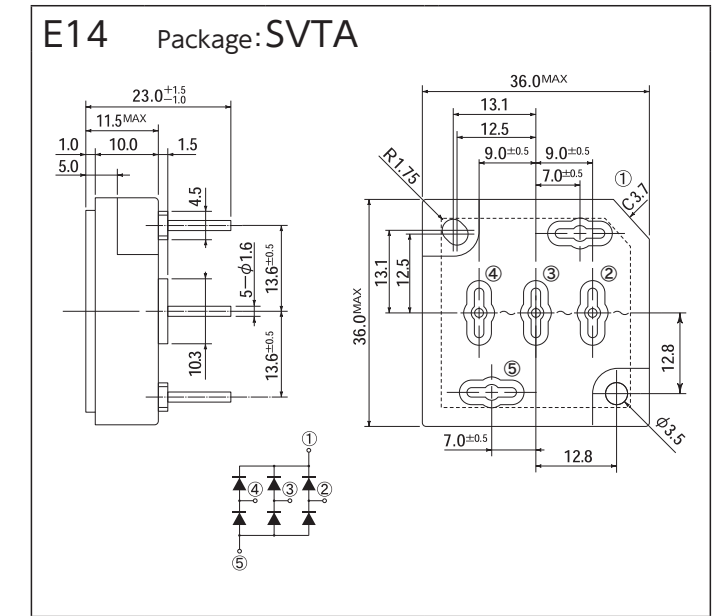

OUTLINE DIMENSIONS

[Unit:mm]

[Unit:mm]

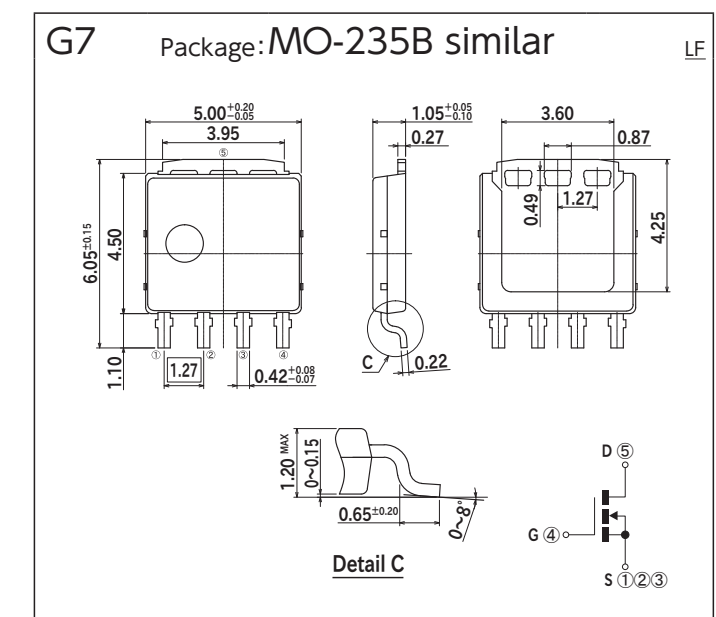
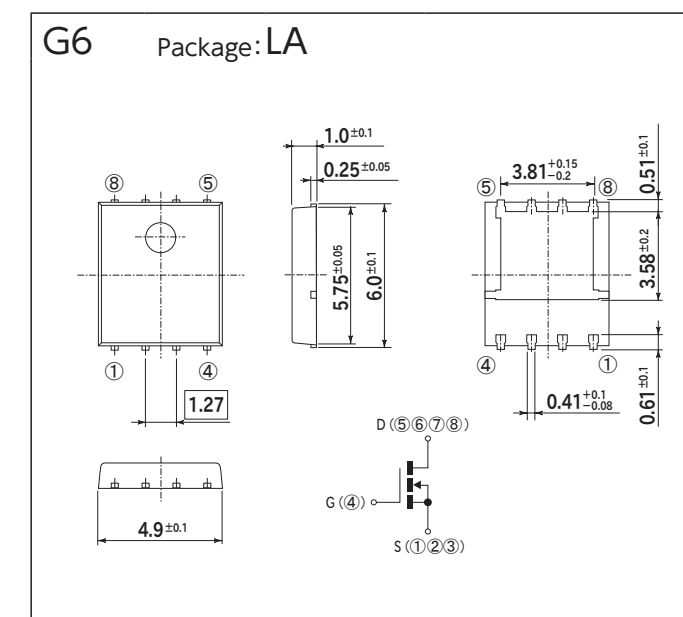
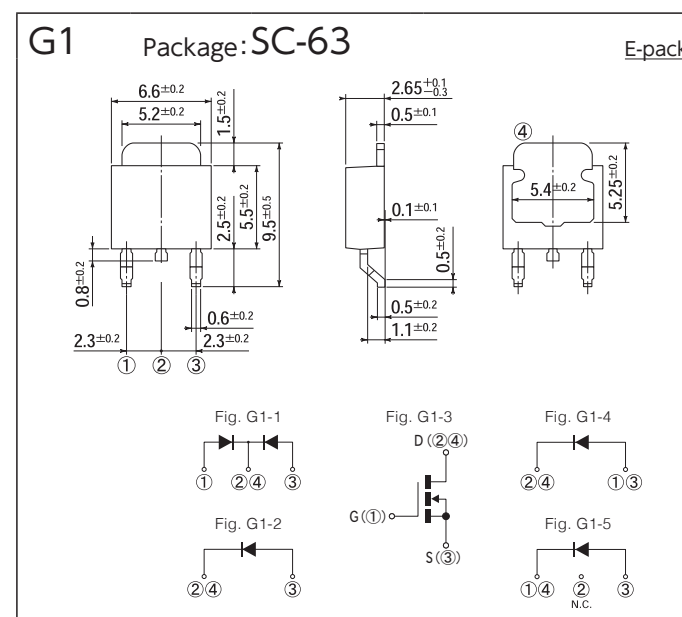
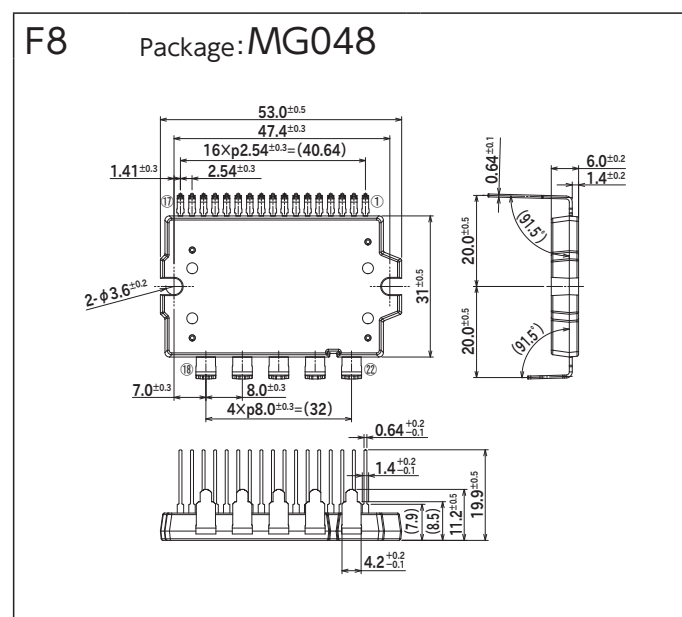
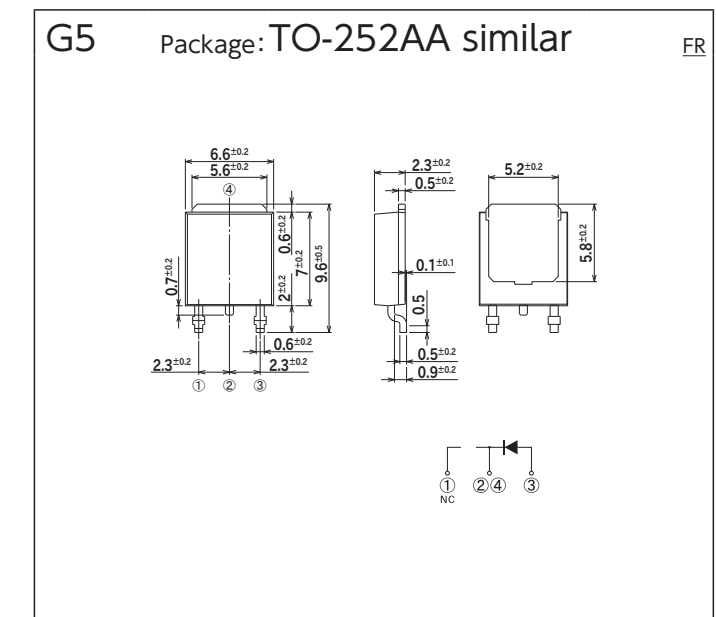
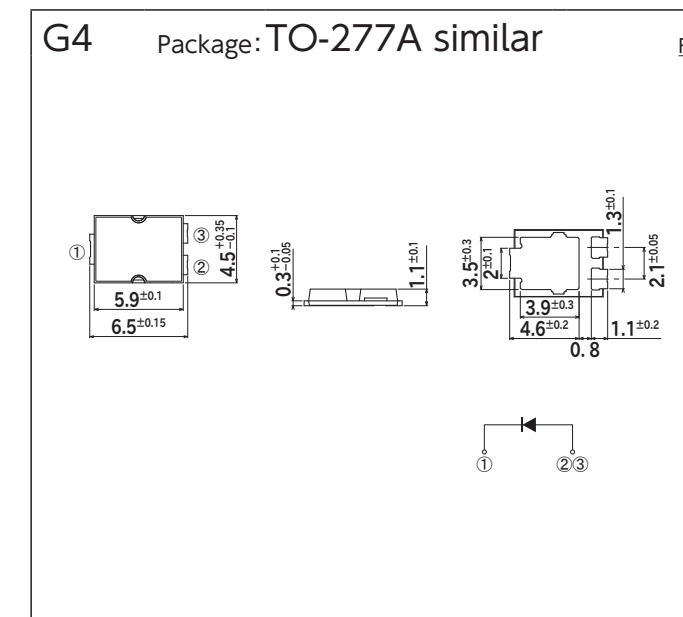
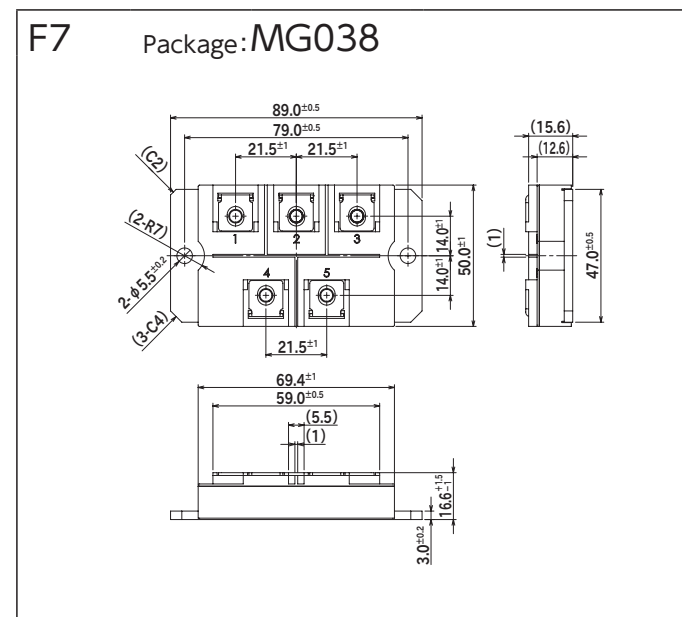
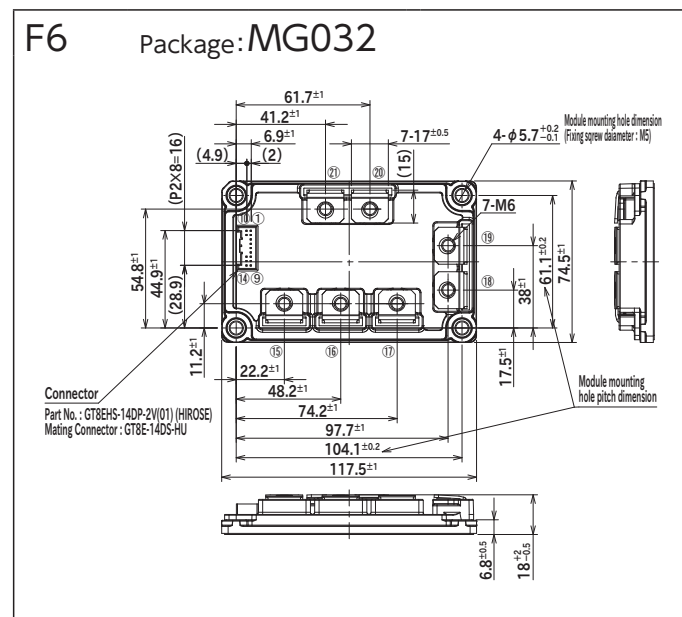
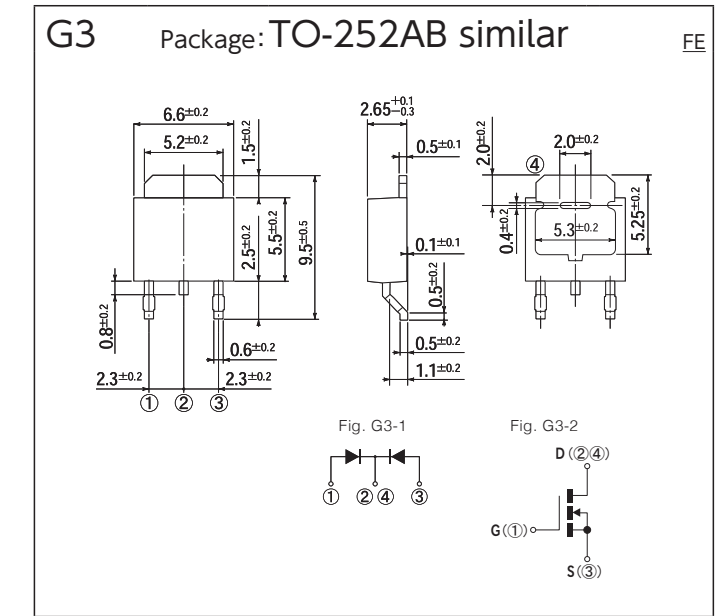
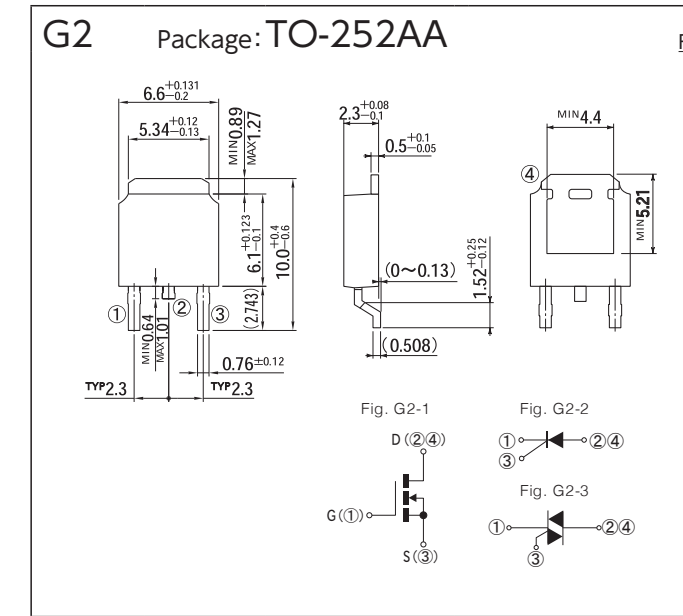
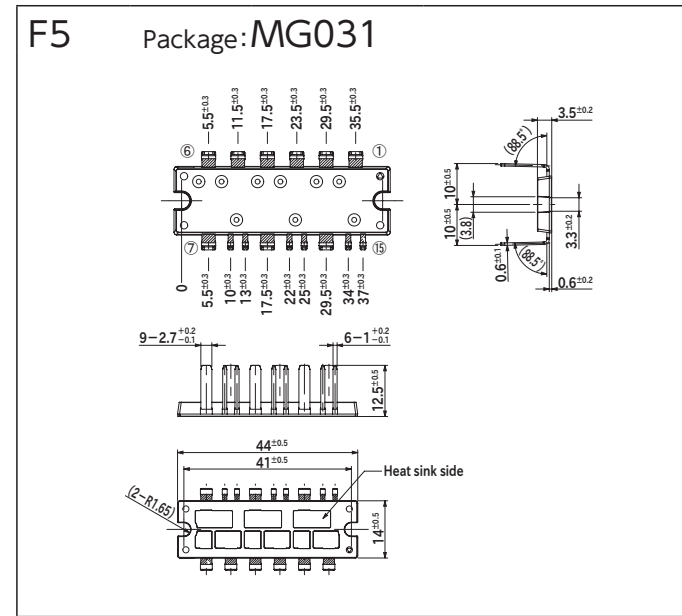
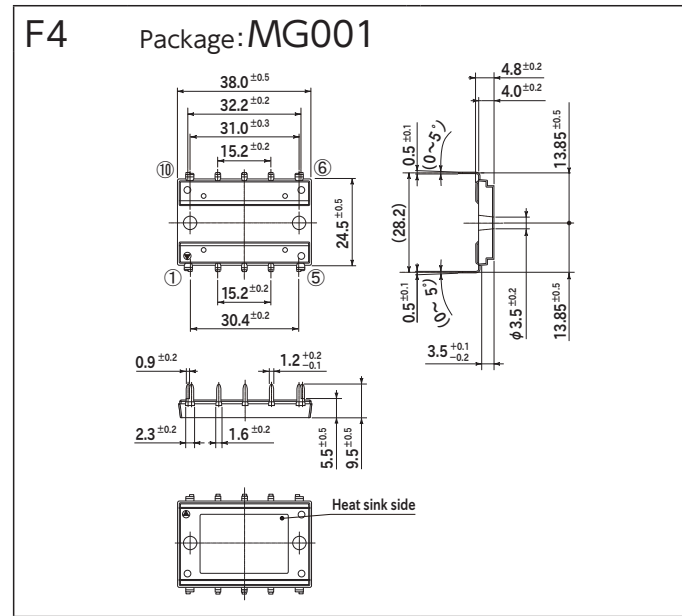

OUTLINE DIMENSIONS

OUTLINE DIMENSIONS

[Unit:mm]

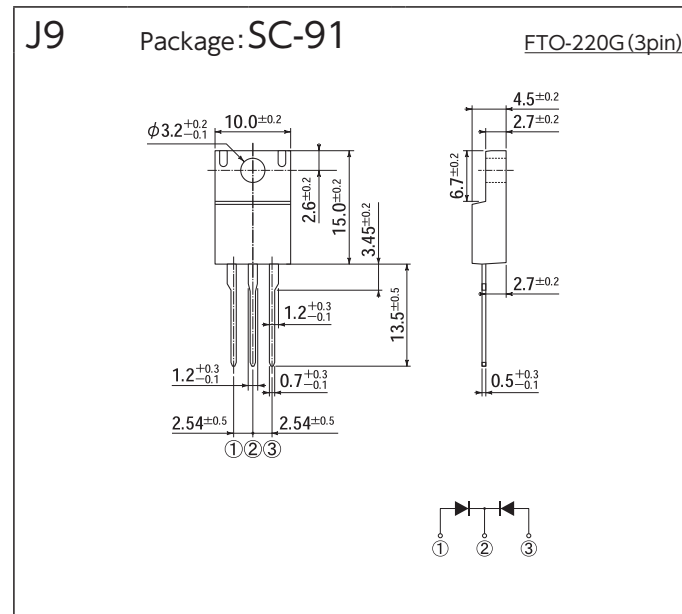
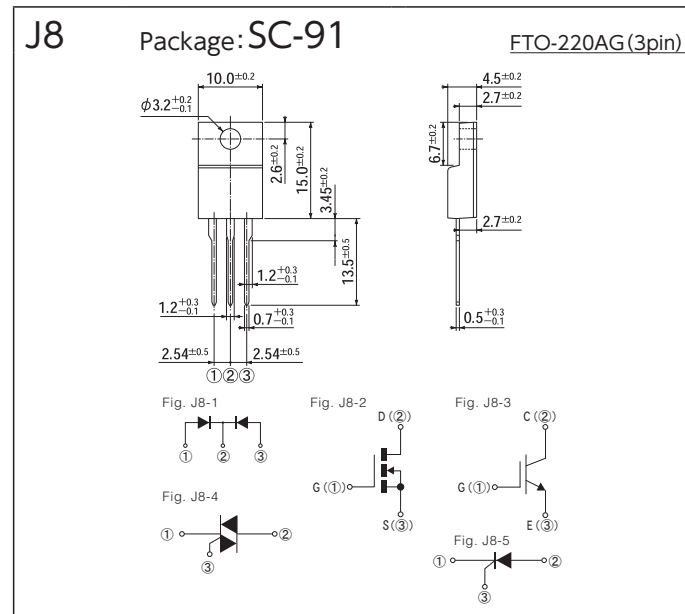
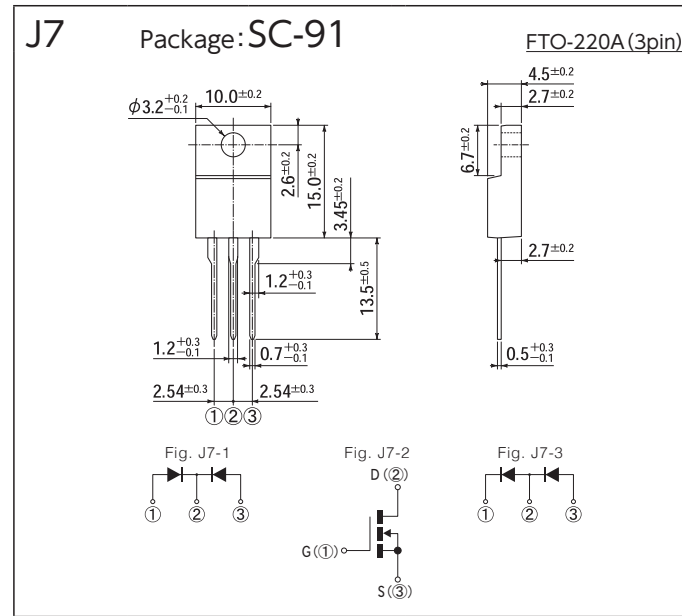
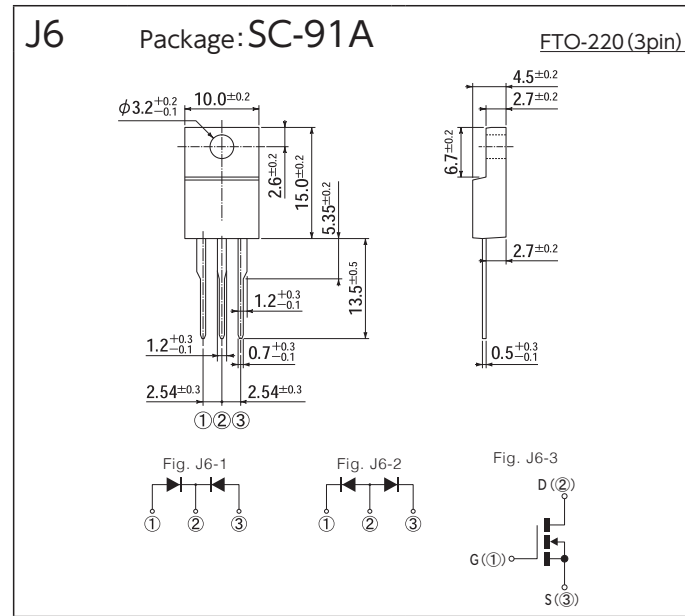

[Unit:mm]

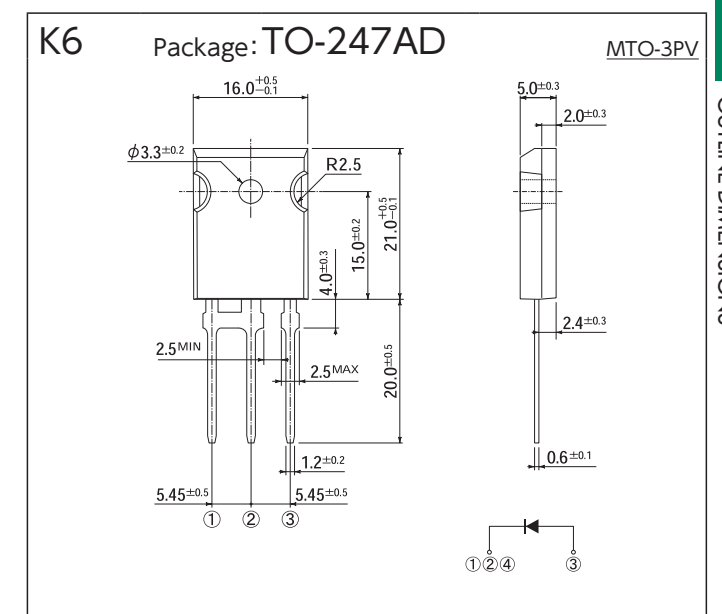
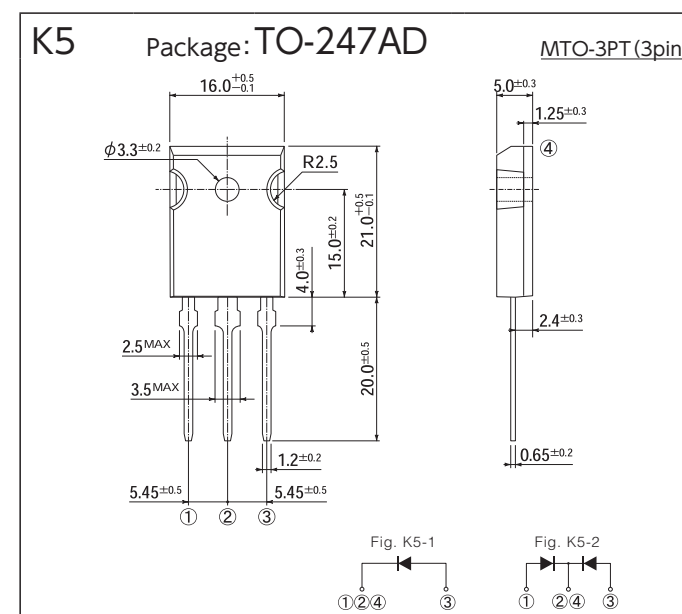
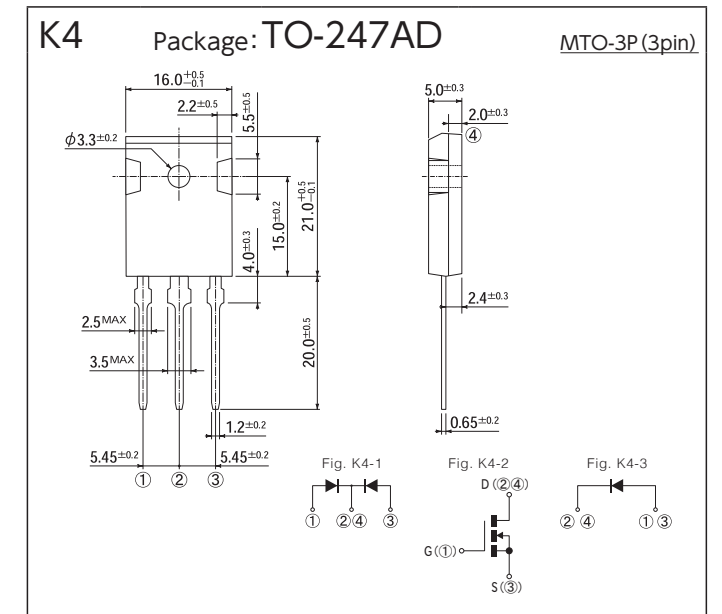
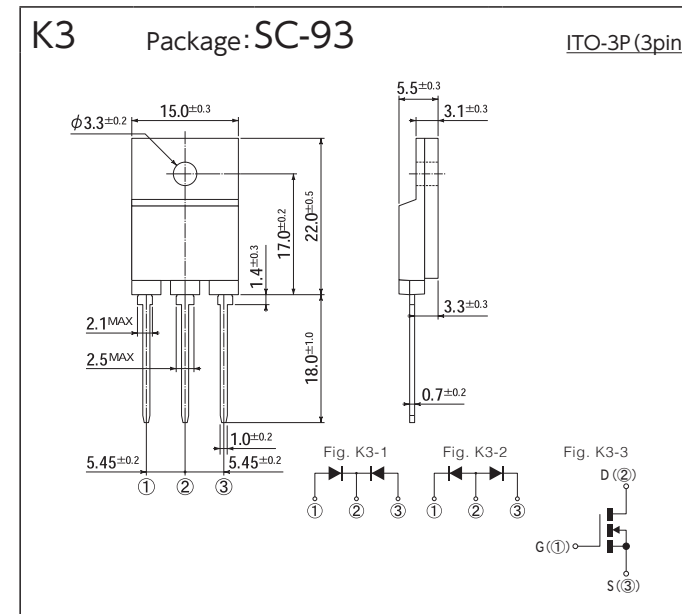
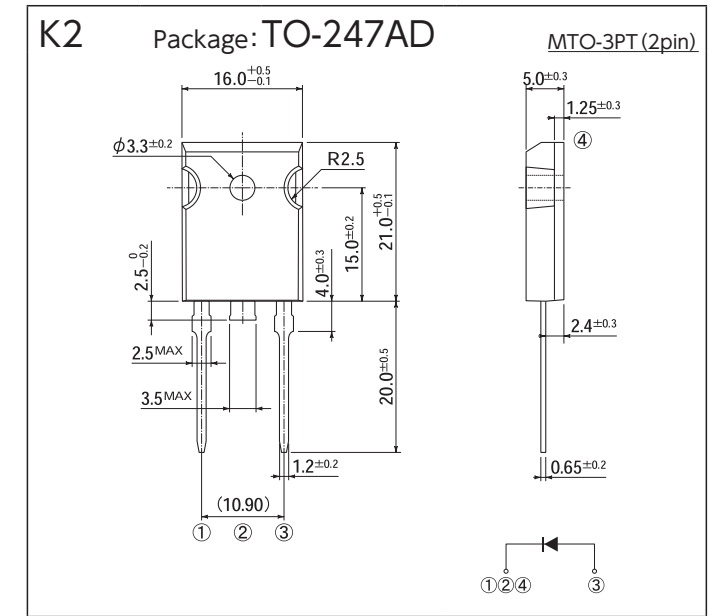
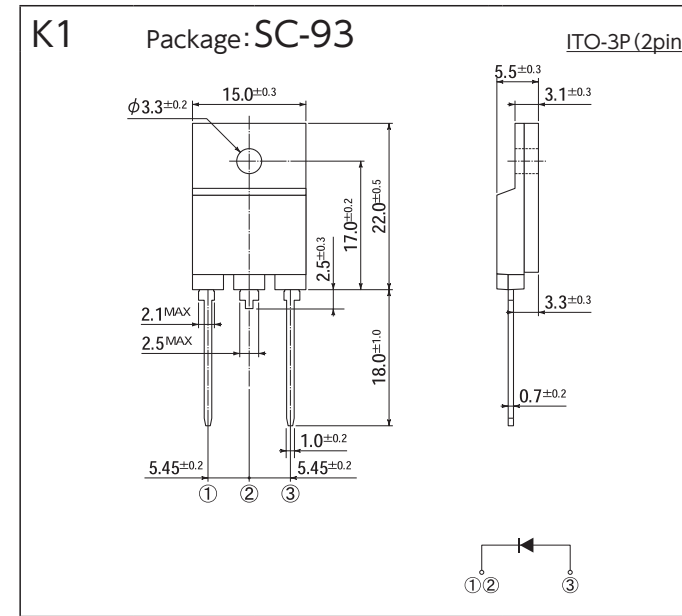

OUTLINE DIMENSIONS

OUTLINE DIMENSIONS

[Unit:mm]

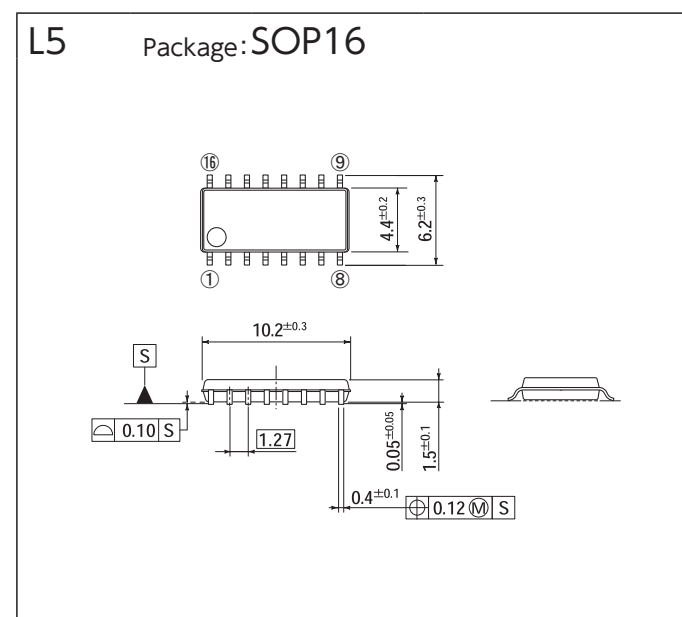
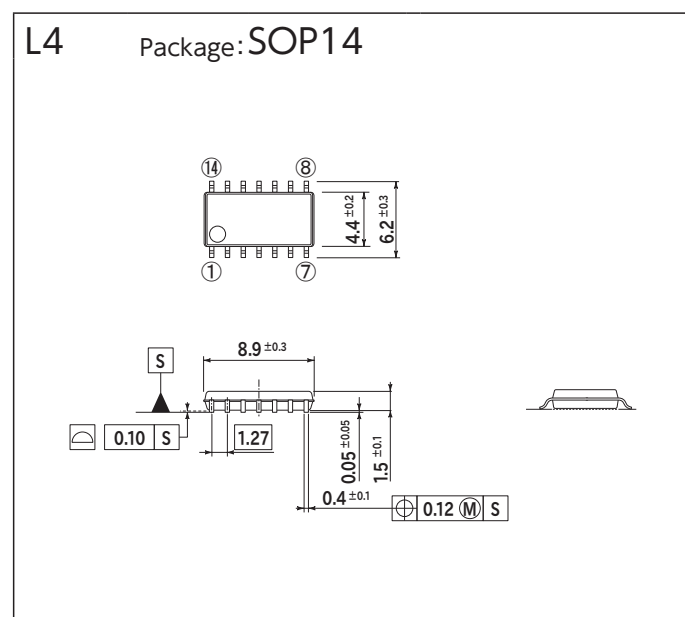
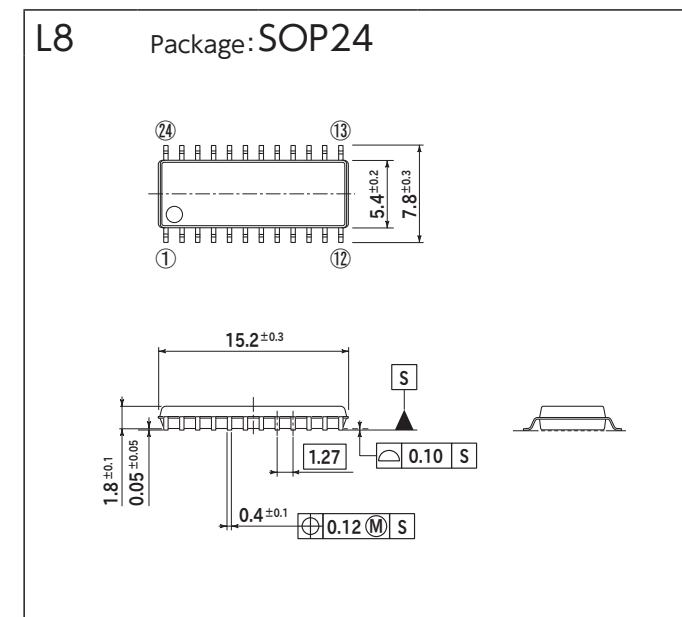
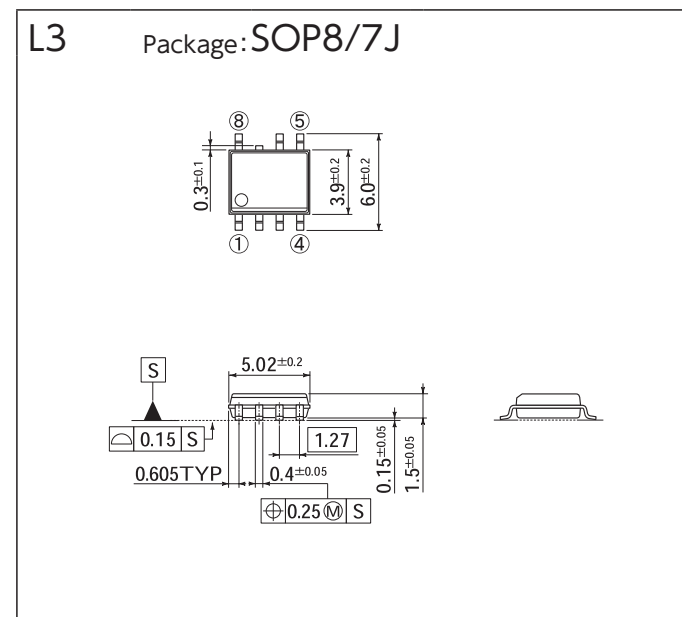
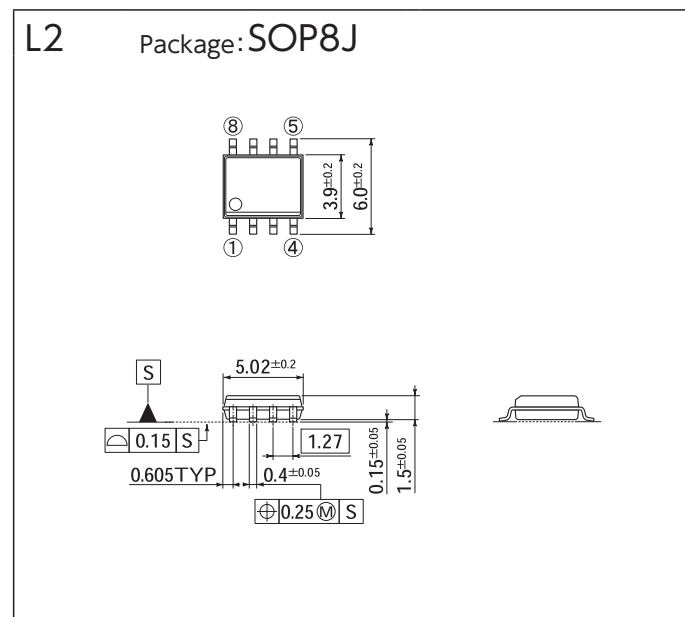
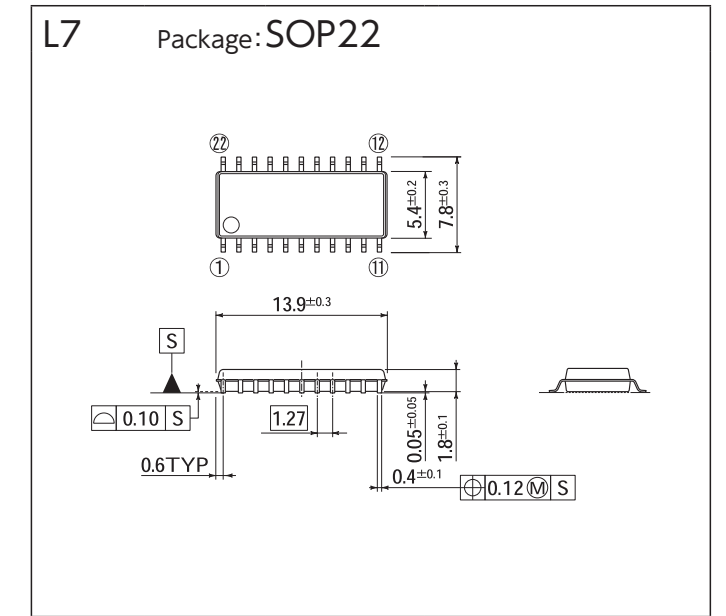
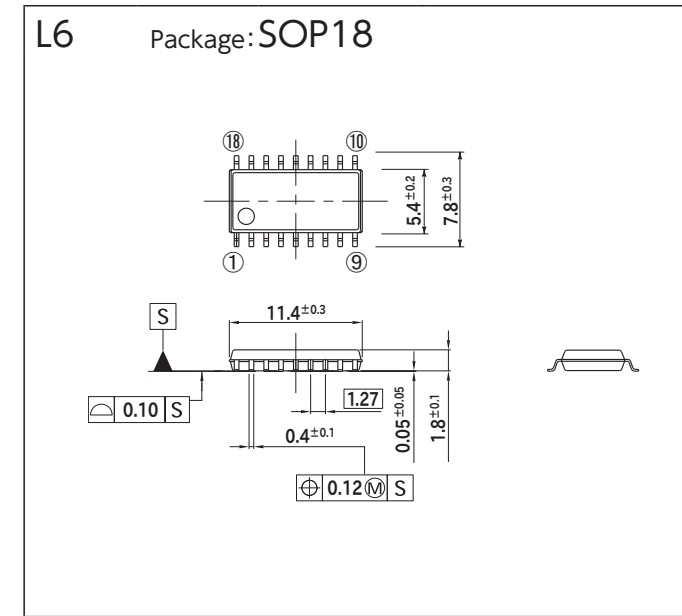
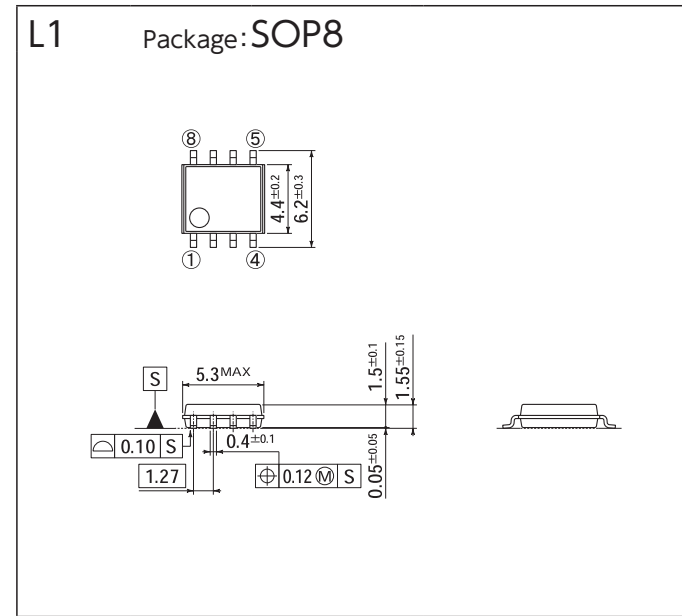
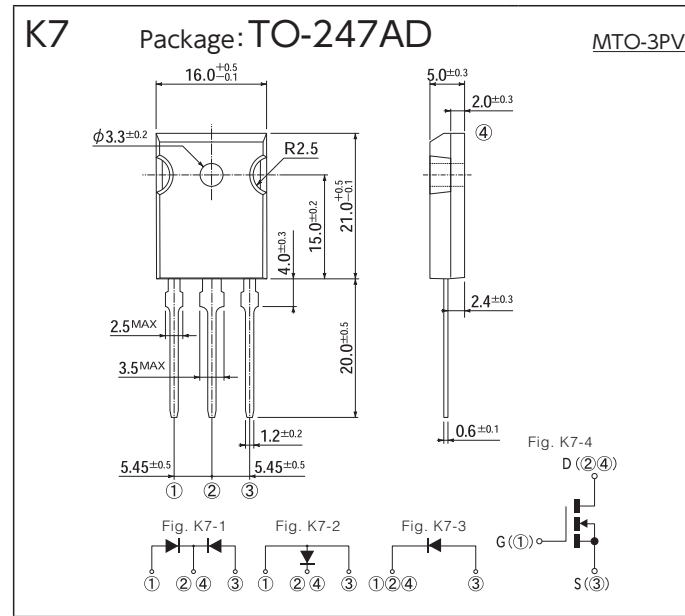

PACKING SPECIFICATION

Please make your order: 'more than Inner Box Quantities' and 'a multiple of each Packing Unit'

Order Quantity & Packing Dimensions List

Please make your order: 'more than Inner Box Quantities' and 'a multiple of each Packing Unit'

Package			Fig.	Spec Code	Terminal Plating	Weight (aprx.)	MSL	Remarks	Inner Box			Standard Packing			Packing Box (mm)			
JEDEC Package Code	JEITA Code	House Name							Method	Quantity (Pcs./Box)	Pcs./Box	Weight (kg)	L	W	H			
-	-	AX057	A1	-5060	Sn	190mg	-		Standard	4,000	Tape, Ammo-Pack 52mm	4,000	32,000	7.5	330	280	270	
-	-	AX06	SIDAC A2 A3	-5070	Sn-Bi	210mg	-		Standard	200	Bulk	200	20,000	5.9	480	355	230	
-	-	AX078	TVS SIDAC A4	-7000	Sn-Bi	390mg	-		Standard	4,000	Tape, Ammo-Pack 52mm	4,000	64,000	14.0	325	325	420	
-	-	AX078	Diodes	-7061						Standard	4,000	Tape&Reel, Diameter 300 φ 52mm	4,000	20,000	6.3	325	325	420
-	-	AX078	Diodes	-7070						Standard	3,000	Tape, Ammo-Pack 26mm	3,000	72,000	15.7	325	325	420
-	-	AX078	Diodes	-5000	Sn					Standard	200	Bulk	200	16,000	7.9	480	355	230
-	-	AX078	Diodes	-5060						Standard	2,000	Tape, Ammo-Pack 52mm	2,000	32,000	14.7	325	325	420
-	-	AX10	TVS SIDAC A5 A6	-7060	Sn-Bi	640mg	-		Standard	2,000	Tape, Ammo-Pack 52mm	2,000	32,000	14.7	325	325	420	
-	-	AX10	Diodes	-7061						Standard	1,500	Tape, Ammo-Pack 26mm	1,500	18,000	7.2	325	325	260
-	-	AX10	Diodes	-5000						Standard	200	Bulk	200	16,000	7.9	480	355	230
-	-	AX10	Diodes	-5060	Sn					Standard	2,000	Tape, Ammo-Pack 52mm	2,000	16,000	7.5	325	325	260
-	-	AX10	Diodes	-5061						Standard	1,500	Tape, Ammo-Pack 26mm	1,500	18,000	7.2	325	325	260
-	-	AX14	A7	-5000	Sn	1.1g	-		Standard	200	Bulk	200	16,000	11.1	480	355	230	
DO-219AB similar	SC-109	G1F	SMD B1	-5063R	Sn	12mg	1		Standard	1,200	Tape, Ammo-Pack 52mm	1,200	9,600	11.2	325	325	260	
DO-219AA similar	M1F	SMD B2	-6063	Sn	25mg	1			Standard	4,000	Tape&Reel, Diameter 180 φ	4,000	48,000	1.6	180	205	210	
DO-219AA similar	-	M1F	SMD B2	-6063	Sn	25mg	1		Standard	2,500	Tape&Reel, Diameter 180 φ	2,500	10,000	13.0	350	355	350	
DO-214AC	-	1F	SMD B3 B4	-5103	Sn	60mg	1		Standard	100	Magazine	100	15,000	2.3	545	145	110	
-	SC-110B	CE	SMD B5	-5063R	Sn	30mg			Standard	2,000	Tape&Reel, Diameter 180 φ	8,000	40,000	4.1	340	195	205	
DO-214AA similar	-	M2F	SMD B6 B7 B8	-5063	Sn	75mg	1		Standard	7,500	Tape&Reel, Diameter 330 φ	45,000	90,000	10.8	395	245	395	
DO-214AA similar	-	M2F	SMD B6 B7 B8	-5073	Sn	75mg	1		Standard	3,000	Tape&Reel, Diameter 180 φ	12,000	24,000	1.6	180	205	210	
-	-	2F	SMD B9 B10	-5103	Sn	180mg	1		Standard	1,000	Tape&Reel, Diameter 180 φ	4,000	20,000	3.4	340	195	205	
-	-	2F	SMD B9 B10	-5063	Sn	180mg	1		Standard	750	Tape&Reel, Diameter 180 φ	3,000	15,000	4.2	340	195	205	
-	-	2F	SMD B9 B10	-5073	Sn	180mg	1		Standard	3,000	Tape&Reel, Diameter 330 φ	3,000	36,000	9.2	395	245	395	
-	-	SOPA-4	SMD C1	-7062	Sn-Bi	90mg	1		Standard	1,000	Tape&Reel, Diameter 180 φ	1,000	20,000	3.6	340	195	205	
TO-269AA	-	1Z	SMD C2	-7102	Sn-Bi	130mg	1		Standard	100	Magazine	100	15,000	3.2	545	145	110	
-	-	1Z	SMD C2	-7062					Standard	S1ZA	750	Tape&Reel, Diameter 180 φ	3,000	15,000	4.0	340	195	205
-	-	1Z	SMD C2	-7062					Standard	S1ZB	750	Tape&Reel, Diameter 180 φ	3,000	15,000	4.0	405	210	220
-	-	1Z	THD C3	-7072					Standard	3,000	Tape&Reel, Diameter 330 φ	3,000	15,000	4.6	340	340	120	
-	-	1Z	THD C3	-7101					Standard	S1ZB	100	Magazine	100	10,000	2.1	545	145	110
-	-	1N	SMD C4	-7102	Sn-Bi	290mg	1		Standard	70	Magazine	70	5,600	4.1	545	145	100	
-	-	1N	SMD C4	-7062					Standard	1,000	Tape&Reel, Diameter 250 φ	1,000	10,000	5.5	275	285	295	
-	-	1N	THD C5	-7101	Sn-Bi	290mg	1		Standard	70	Magazine	70	5,600	4.1	545	145	100	
-	-	1NA	SMD C6	-7102	Sn-Bi	290mg	1		Standard	70	Magazine	70	5,600	4.1	545	145	100	
-	-	1NA	THD C7	-7101					Standard	1,000	Tape&Reel, Diameter 250 φ	1,000	10,000	5.5	275	285	295	
-	-	1W	SMD C8	-7102	Sn-Bi	500mg	1		Standard	70	Magazine	70	5,600	4.1	545	145	100	
-	-	1W	SMD C8	-7062					Standard	50	Magazine	50	4,000	4.4	545	145	110	
-	-	1W	THD C9	-7072					Standard	1,000	Tape&Reel, Diameter 330 φ	3,000	6,000	5.5	395	245	395	
-	-	1W	THD C9	-7101	Sn-Bi	500mg	1		Standard	2,000	Tape&Reel, Diameter 380 φ	2,000	10,000	7.8	395	245	395	
-	-	D3K	THD D1	-7000	Sn-Bi	1.5g	-		Standard	50	Magazine	50	4,000	4.4	545	145	110	
-	-	2S	THD D2	-7000	Sn-Bi	2.1g	-		Standard	500	Bulk	500	2,500	4.0	210	188	200	
-	-	3S	THD D3	-7000	Sn-Bi	3.9-4.5g	-		Standard	100	Bulk	100	6,000	14.4	410	380	170	
-	-	5S	THD D4	-7000	Sn-Bi	6.3-7.5g	-		Standard	50	Bulk	50	2,000	9.5	310	285	196	
-	-	JB	THD D5	-7000	Sn-Bi	2.7g	-		Standard	250	Bulk	250	2,000	14.5	330	330	215	
-	-	JA	THD D6	-7000	Sn-Bi	4.5g	-		Standard	250	Bulk	250	2,000	7.4	287	301	169	
-	-	TSB	THD (4pin) D7	-7000	Sn-Bi	20g	-		Standard	250	Bulk	250	2,000	9.0	327	329	185	
-	-	TSB	THD (5pin) D8	-7000	Sn-Bi	20g	-		Standard	100	Bulk	100	400	9.8	351	269	164	
-	-	JC	THD (4pin) D7	-7500	Sn-Bi	20g	-		Standard	40	Tray	40	200	5.6	503	356	135	
-	-	JC	THD (5pin) D8	-7500	Sn-Bi	20g	-		Standard	40	Tray	40	200	5.6	503	356	135	
-	-	JF	THD D9	-7500	Sn-Bi	25g	-		Standard	40	Tray	40	200	5.6	503	356	135	
-	-	JH	THD D10	-7501	Sn-Bi	31g	-		Standard	40	Tray	40	200	5.6	503	356	135	
-	-	MCP	SMD E1	-4062	Ni	1.9g	1		Standard	300	Tape&Reel, Diameter 255 φ	300	1,500	5.0	280	275	190	
-	-	MCP	SMD E1	-4072					Standard	600	Tape&Reel, Diameter 330 φ	600	1,800	5.5	335	345	110	

Exterior packaging is an example. Depending on the quantity ordered, the number of incoming, outline and weight may change.

Package														Inner Box				Standard Packing			Packing Box (mm)		
JEDEC Package Code	JEITA Code	House Name		Fig.	Spec Code	Terminal Plating	Weight (aprx.)	MSL	Remarks	Quantity	Method	Quantity (Pcs./Box)	Pcs./Box	Weight (kg)	L	W	H						
-	-	D30VC	THD	E2	-4000	Ag	12g	-		100	Tray	100	500	7.0	375	285	160						
-	-	S2VB	THD	E3	-5000	Sn-Ag-Cu	3.0g	-		100	Tray	100	1,000	3.6	265	255	170						
-	-	S4VB	THD	E4	-5000	Sn-Ag-Cu	5.2g	-		100	Tray	100	1,000	5.9	315	285	220						
-	-	S5VB	THD	E5	-5000	Sn-Ag-Cu	9.1g	-		100	Tray	100	1,000	10.4	415	285	300						
-	-	S10VB	THD	E6	-5000	Sn-Ag-Cu	8.0g	-		100	Tray	100	1,000	9.3	375	285	270						
-	-	S15VB	THD	E7	-4000	Ag	16g	-		100	Tray	100	500	9.0	415	285	180						
-	-	S25VB	THD	E8	-4000	Ag	21g	-		60	Bulk	60	300	7.0	335	205	165						
-	-	S50VB	THD	E9	-4000	Ag	28g	-		50	Tray	50	200	6.2	335	205	165						
-	-	S3WB	THD	E10	-5000	Sn-Ag-Cu	5.1g	-		100	Tray	100	1,000	6.1	315	285	220						
-	-	S10WB	THD	E11	-5000	Sn-Ag-Cu	9.0g	-		100	Tray	100	1,000	9.3	375	285	270						
-	-	S15WB	THD	E12	-5000	Sn-Ag-Cu	16g	-		100	Tray	100	1,000	15.1	415	285	300						
-	-	S20WB	THD	E13	-5000	Sn-Ag-Cu	20g	-		100	Tray	100	700	15.0	415	285	300						
-	-	SVTA	THD	E14	-5000	Sn-Ag-Cu	30g	-		50	Tray	50	250	8.7	460	295	240						
-	-	SVT	THD	E15	-4000	Ag	31g	-		45	Bulk	200	200	13.6	335	205	165						
-	-	MODULE		F1 F2 F3	-4000	Ni	42-66g	-		25	Tray	100	200	13.4	480	330	210						
-	-	MG001	THD	F4	-7101	Sn-Bi	10g	-		15	Magazine	15	450	7.1	623	232	144						
-	-	MG031	THD	F5	-7101	Sn-Bi	7.7g	-		12	Magazine	12	600	8.5	573	281	127						
-	-	MG032		F6	-4500	Ni	340g	-		24	Tray	24	24	80	610	315	140						
-	-	MG038		F7	-4500	Ni	180g	-		40	Tray	40	40	90	425	360	155						
-	-	MG048	THD	F8	-7101	Sn-Bi	7.7g	-		9	Magazine	9	-	-	-	-	-						
-	-	Only DE5VE40		G1	-5101	Sn	310mg	1	Standard	80	Magazine	80	10,000	6.9	560	130	109						
-	-	Other		G1	-5061					Standard	1,500	Tape&Reel, Diameter 250 φ	1,500	6,000	2.9	260	260	99					
-	-	Other		G1	-5071					Standard	3,000	Tape&Reel, Diameter 330 φ	3,000	12,000	5.5	335	335	99					
-	-	Other		G1	-7101					Standard	80	Magazine	80	10,000	6.9	560	130	109					
-	-	Other		G1	-7061	Sn-Bi				Standard	1,500	Tape&Reel, Diameter 250 φ	1,500	6,000	2.9	260	260	99					
-	-	Other		G1	-7071				Standard	3,000	Tape&Reel, Diameter 330 φ	3,000	12,000	5.5	335	335	99						
TO-252AA	-	FB	SMD	G2	-5071	Sn	320mg	1	Standard	3,000	Tape&Reel, Diameter 330 φ	6,000	36,000	18.2	380	365	390						
TO-252AB similar	SC-63	FE	SMD	G3	-5061	Sn	320mg	1	Only Di (Di, MOS)	1,500	Tape&Reel, Diameter 254 φ	1,500	6,000	2.9	260	260	99						
TO-252AB similar	SC-63	FE	SMD	G3	-5071	Sn	320mg	1	Standard	3,000	Tape&Reel, Diameter 330 φ	3,000	12,000	5.5	335	335	99						
TO-277A similar	-	FY	SMD																				

NOTES

How to Order

1. Indication of Spec. Code when ordering

Please specify the Spec. Code when ordering semiconductors.
For the Spec. Code, Please refer to as follows and "PACKING SPECIFICATION".

Example Ordering THD type of S1ZB60
S1ZB60-7101

2. Spec Code

The code specifies each packing form, lead forming and terminal plate material.
Please refer to "PACKING SPECIFICATION".

Example 5 0 0 0

- Terminal forming
 - 0 : Straight terminal
 - 1 to 9 : Each number shows type of form
- Packing form
 - 0 : Standard
 - In case of surface mounting devices
 - 5, 6 : Small reel
 - 7 : Large reel
 - In case of axial device
 - 6 : Lead length 52mm (T52)
 - 7 : Lead length 26mm (T26)
- Minimum packing unit
 - 0 : Bulk, tray or taping
 - 1 : Magazine
 - 5 : Tray
 - 6 : Packed (FTO-220 Package)
- Terminal plate material
 - 3 : Ni/Pd/Au, Sn-Ag
 - 4 : Ni, Ag
 - 5 : Sn-Ag-Cu, Sn, Ag, Sn-Cu
 - 6 : Sn
 - 7 : Sn-Bi

Outline of Packing Form

1. Minimum packing unit

- Bulk : The form in which parts are inserted into plastic bags or cardboard boxes.
- Tray : The form in which parts are inserted in to containers made of resin.



- Magazine : The form in which parts are inserted into resin cartridges designated for automatic inserters.



- Taping
 - Reel (Surface mounting devices)



- Box (Axial devices)



2. Packing Box Dimensions

See the following pages for the dimensions of each cardboard box.

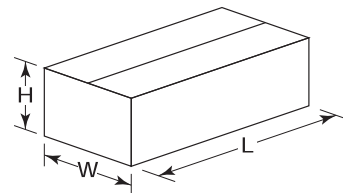

About AEC-Q101 & Automotive Grade

1. AEC-Q101

These products are AEC-Q101 compliant.

2. Automotive Grade

These products are produced on a designated production line qualified for internal automotive standards.

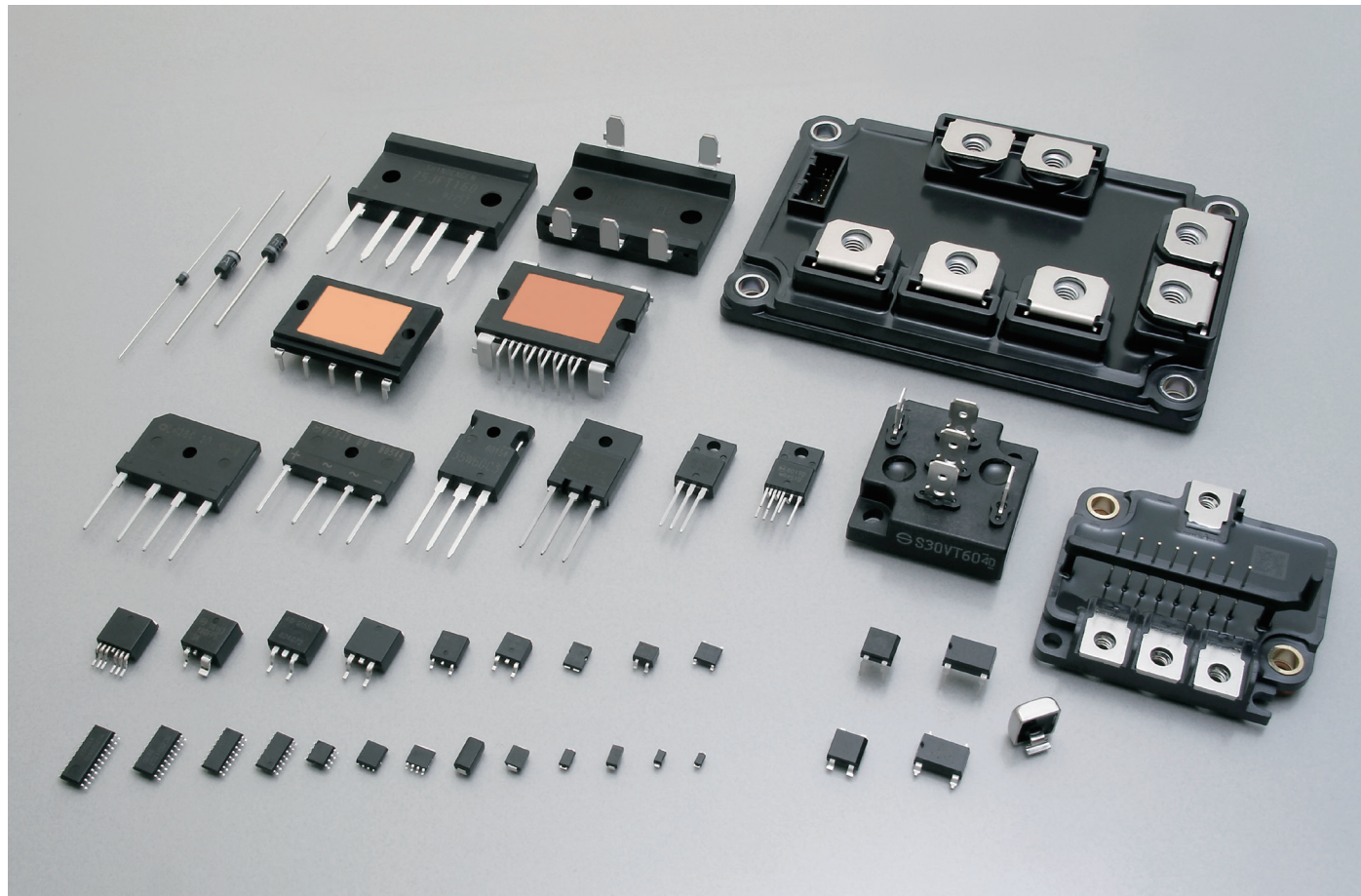

Notes

- ⚠ If you wish to use any such product, please be sure to refer to the specifications issued by Shindengen.
- ⚠ All products described or contained herein are designed with a quality level intended for use in standard applications requiring an ordinary level of reliability. If these products are to be used in equipment or devices for special or specific applications requiring an extremely high grade of quality or reliability in which failures or malfunctions of products may directly affect human life or health, a local Shindengen office must be contacted in advance to confirm that the intended use of the product is appropriate. Shindengen products are grouped into the following three applications according to the quality grade.
 - Standard applications
Computers, office automation and other office equipment, communication terminals, test and measurement equipment, audio/visual equipment, amusement equipment, consumer electronics, machine tools, personal electronic equipment, industrial equipment, etc.
 - Special applications
Transportation equipment (vehicles, ships, etc.), trunk-line communication equipment, traffic signal control systems, anti-disaster/crime systems, safety equipment, medical equipment, etc.
 - Specific applications
Nuclear reactor control systems, aircraft, aerospace equipment, submarine repeaters, life support equipment and systems, etc.
- ⚠ Although Shindengen continuously endeavors to enhance the quality and reliability of its products, customers are advised to consider and take safety measures in their design, such as redundancy, fire containment and anti-failure, so that personal injury, fires, or societal damages can be prevented.
- ⚠ Please note that all information described or contained herein is subject to change without notice due to product upgrades and other reasons. When buying Shindengen products, please contact the Company's offices or distributors to obtain the latest information.
- ⚠ Shindengen shall not bear any responsibility with regards to damages or infringement of any third-party patent rights and other intellectual property rights incurred due to the use of information on this website.
- ⚠ The information and materials on this website neither warrant the use of Shindengen's or any third party's patent rights and other intellectual property rights, nor grant license to such rights.
- ⚠ In the event that any product described or contained herein falls under the category of strategic products controlled under the Foreign Exchange and Foreign Trade Control Law of Japan, exporting of such products shall require an export license from the Japanese government in accordance with the above law.
- ⚠ No reprinting or reproduction of the materials on this website, either in whole or in part, is permitted without proper authorization from Shindengen.

SALES OFFICES

U.S.A.

Shindengen America, Inc. www.shindengen.com/

2333 Waukegan Road Suite250, Bannockburn, IL.60015. U.S.A
Phone:+1-847-444-1363 FAX:+1-847-444-0654

Europe

Shindengen UK Ltd. www.shindengen.co.eu/

Head Office
Unit 1, 1 Tapper Walk, King's Cross, London, N1C 4AQ U.K.
Phone:+44-20-3829-6980 FAX:+44-20-3725-6855

German Branch
Prinzenallee 1, 40549 Düsseldorf, Germany
Phone:+49-211-5206-590 FAX:+49-211-4986-499

Asia

Shindengen Singapore PTE Ltd.

750d, Chai Chee Road, #05-01,
Viva Business Park, Singapore 469004
Phone:+65-6445-0082 FAX:+65-6445-6089

Shindengen (H.K.) Co., Ltd.

Head Office
Suite 2006B, 20/F., Exchange Tower, 33 Wang Chiu Road,
Kowloon Bay, HK
Phone:+852-2317-1884 FAX:+852-2314-8561

Taiwan Representative Office
20Fl, No.85, Sec.1, Jhongsiao E. Road, Taipei, 10049,
Taiwan, R.O.C.
Phone:+886-2-2321-3990 FAX:+886-2-2358-3991

Shindengen (SHANGHAI) Electric Co., Ltd.

Room1506, Sheng Gaolnt'l Building, 137 Xian Xia Road,
Chang Ning, Shanghai, China
Phone:+86-21-6270-8000 FAX:+86-21-6270-0419

Shindengen Electric Mfg. Co., Ltd.

Seoul Office
B701-4. 230, Simin-daero, Dongan-gu, Anyang-si,
Gyeonggi-do, 14067 Korea
Phone:+82-31-385-1431 FAX:+82-31-385-1430

- All specifications are subject to change without notice.
- Please consult us for the latest specifications before you order.
- Please use this products after reading manual well.

• Printed January 2020

This catalog includes the products which might be subject to the foreign exchange and foreign trade laws.

Japan

Shindengen Electric MFG. Co., Ltd. www.shindengen.co.jp/

Head Office
New-Ohtemachi Bldg., 2-2-1, Ohtemachi, Chiyoda-ku,
Tokyo 100-0004, Japan
Phone:+81-3-3279-4431 FAX:+81-3-3279-6478

Osaka Branch Office
Minami Senba Heart Bldg., 2-3-2, Minami-Senba,
Chuo-ku, Osaka City, Osaka 542-0081, Japan
Phone:+81-6-6264-7770 FAX:+81-6-6260-1222

Nagoya Branch Office
Nagoya Daiichi Bldg., 1-19-24, Nishiki, Naka-ku,
Nagoya City, Aichi 460-0003, Japan
Phone:+81-52-221-1361 FAX:+81-52-201-4780

Hamamatsu branch
Hamamatsu Daiichi Seimei Nittsu Bldg., 110-5, Itaya-cho,
Naka-ku, Hamamatsu City, Shizuoka 430-0928, Japan
Phone:+81-53-450-3800 FAX:+81-53-450-3801

Utsunomiya Sales Office
Flora Bldg., 1-9-15 Higashi Syukugou Utsunomiya City,
Tochigi 321-0953, Japan
Phone:+81-28-637-3615 FAX:+81-28-637-3115

Package Outline

* = Similar Package

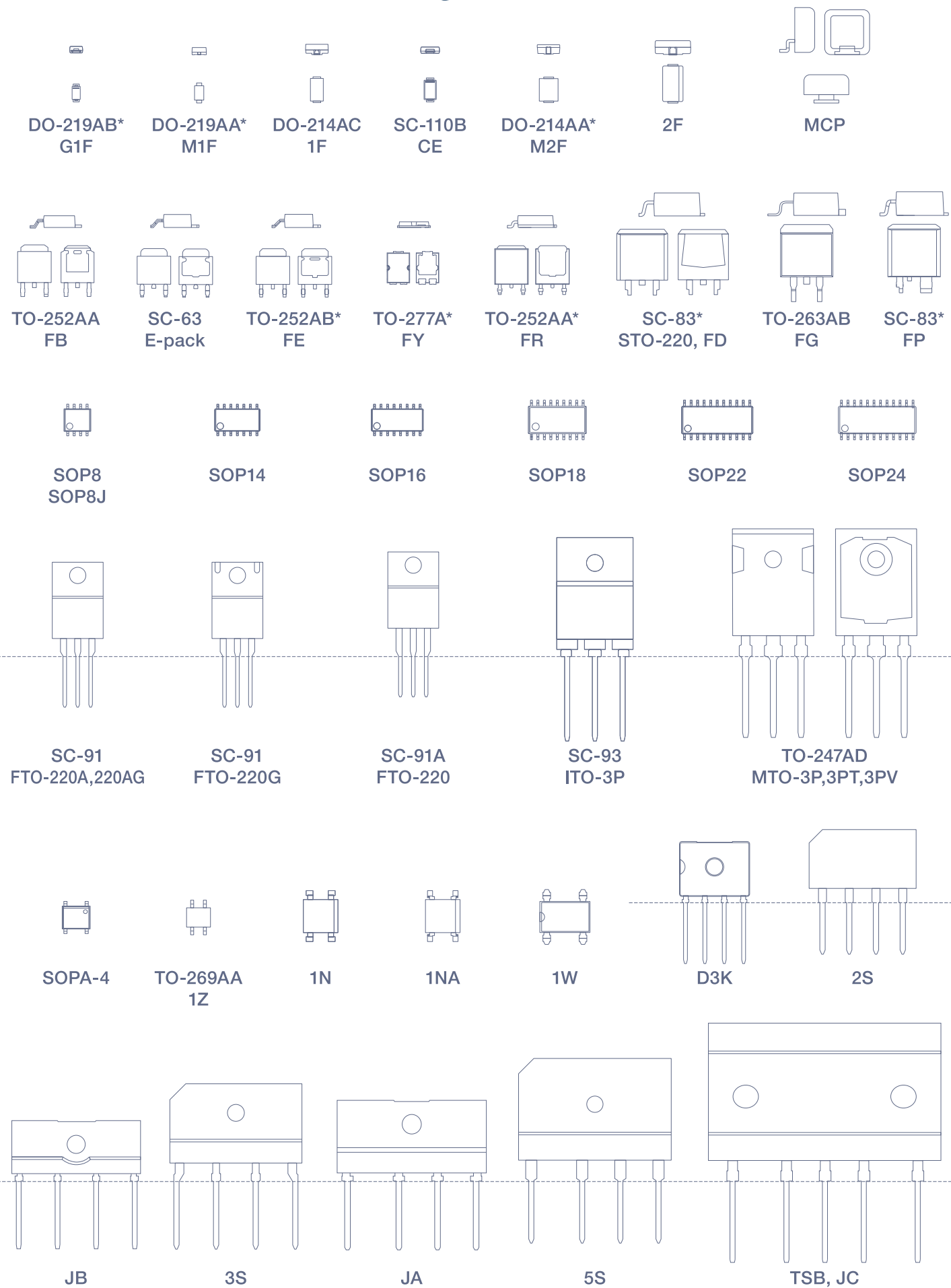

Semiconductor Product Catalog

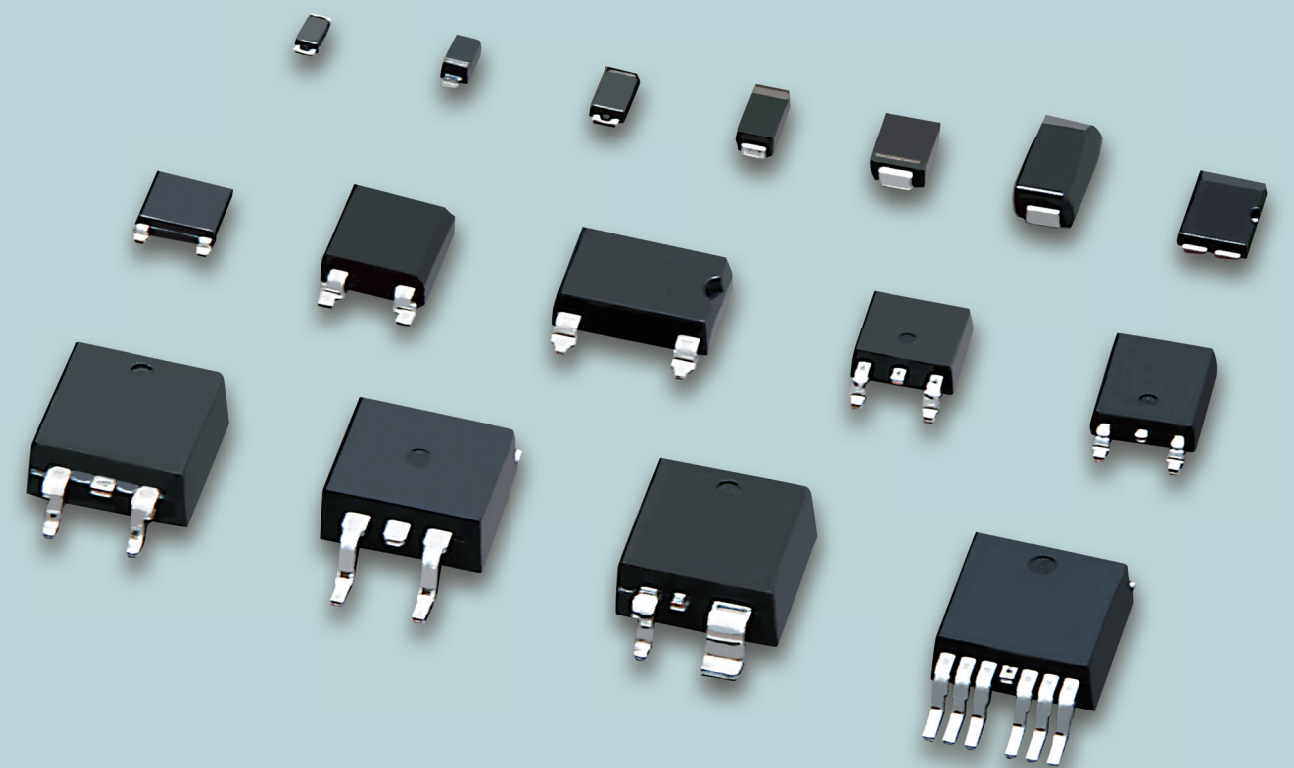

Shindengen Electric Manufacturing Co., Ltd.
www.shindengen.co.jp



CAT.NO.F072-13

1901-3500(1)

ShinDengen
New power. Your power.

X-ON Electronics

Largest Supplier of Electrical and Electronic Components

Click to view similar products for [Zener Diodes](#) category:

Click to view products by [Shindengen](#) manufacturer:

Other Similar products are found below :

[RKZ13B2KG#P1](#) [DL5234B](#) [1N4682](#) [1N4693](#) [1N4732A](#) [1N4736A](#) [1N4750A](#) [1N4759ARL](#) [1N5241B](#) [1N5365B](#) [1N5369B](#) [1N747A](#)
[1N964B](#) [1N966B](#) [1N968B](#) [1N972B](#) [JANS1N4974US](#) [1N4692](#) [1N4702](#) [1N4704](#) [1N4711](#) [1N4714](#) [1N4745ARL](#) [1N4752ARL](#) [1N4760ARL](#)
[1N5221B](#) [1N5242BTR](#) [1N5350B](#) [1N5352B](#) [1N961BRR1](#) [1N964BRL](#) [RKZ5.1BKU#P6](#) [3SMAJ5946B-TP](#) [3SMAJ5950B-TP](#)
[MMSZ5230BQ-13-F](#) [MMSZ5232BQ-13-F](#) [BZX84C7V5](#) [3SMAJ5945B-TP](#) [3SMAJ5947B-TP](#) [3SMBJ5941B-TP](#) [DZ2S240M0L](#) [SMAZ27-](#)
[TP](#) [ZMM5224B-7](#) [RD16UM-T1-A](#) [RD10S-T1-A](#) [CDZT2R5.6B](#) [1N4762A G](#) [Z1SMA18](#) [JANTX1N4553B](#) [SMB01-20](#)