

Package Outline

* = Similar Package

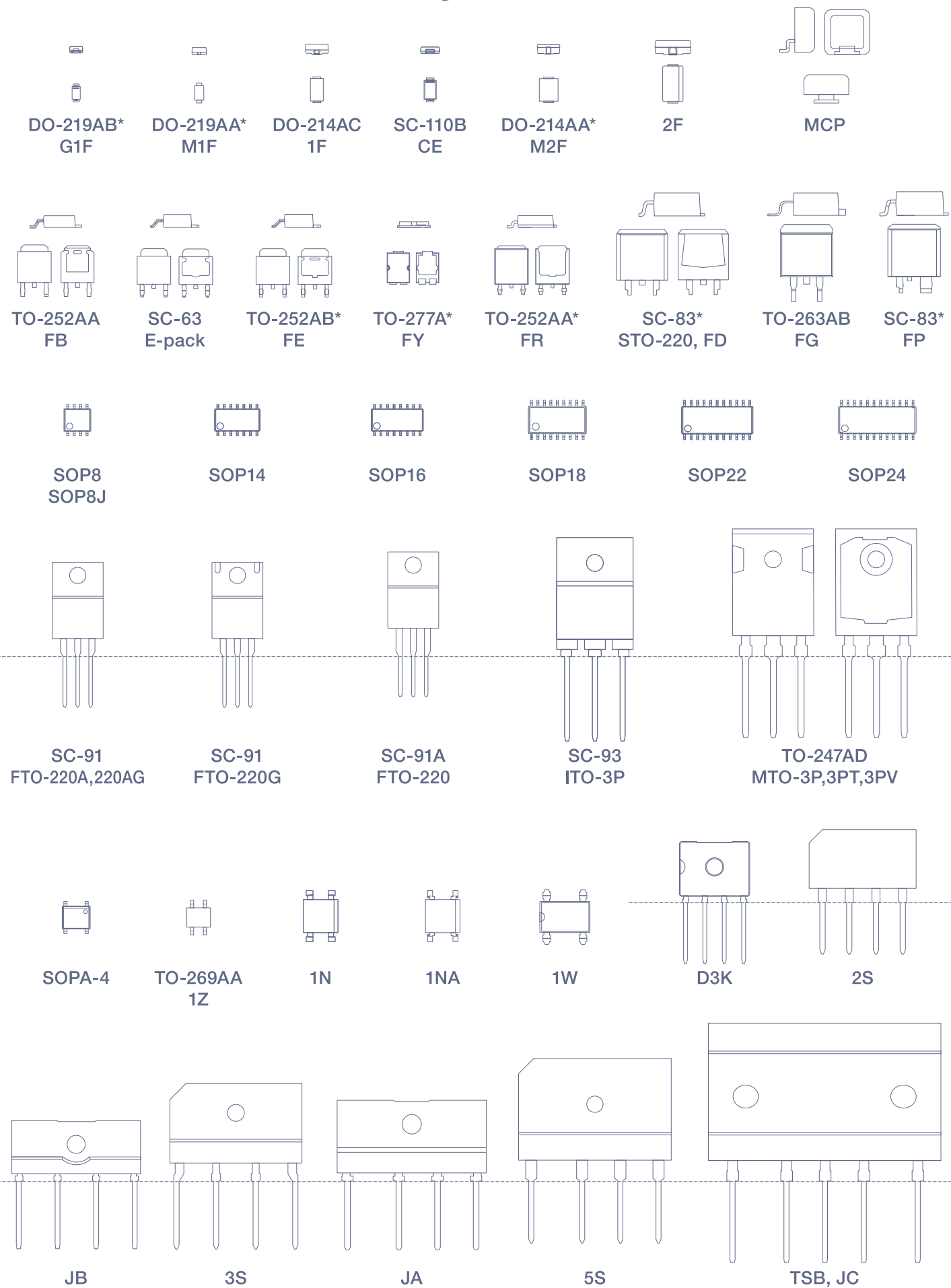

Semiconductor Product Catalog

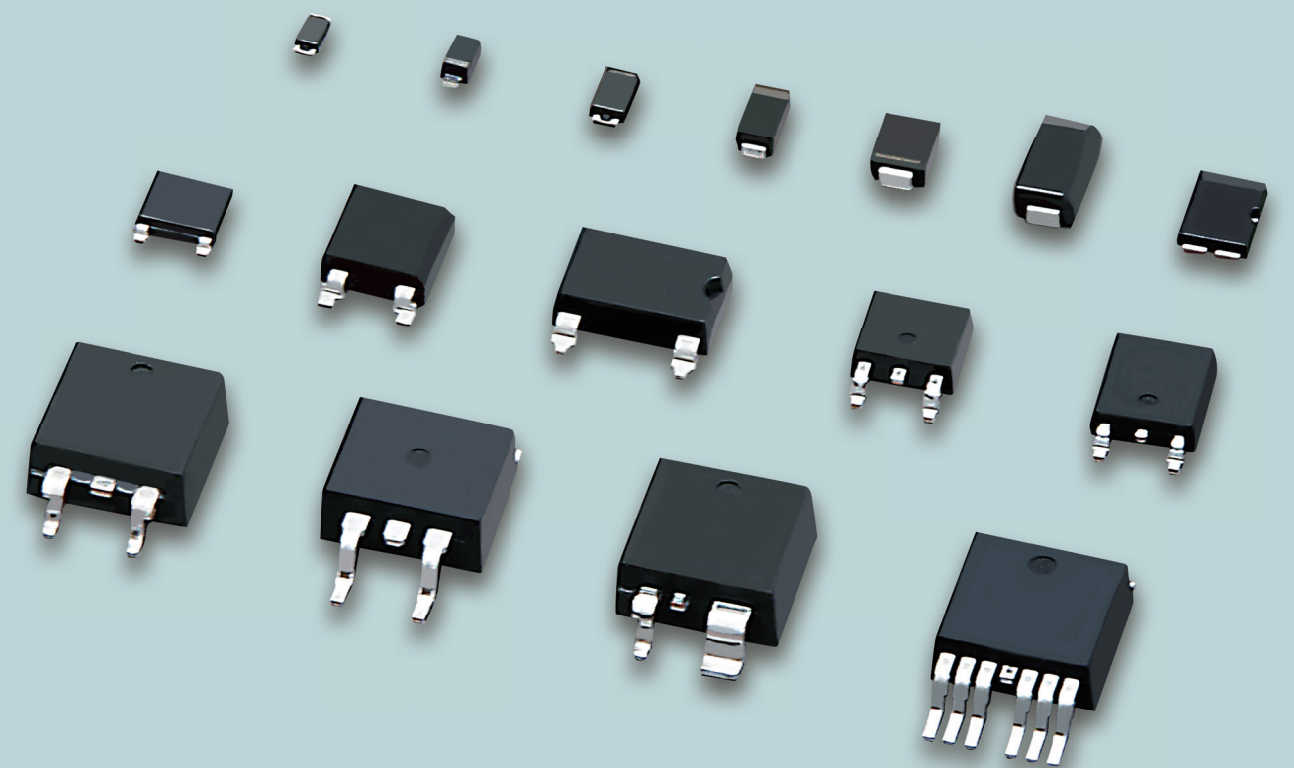

Shindengen Electric Manufacturing Co., Ltd.
www.shindengen.co.jp



CAT.NO.F072-13

1901-3500(1)

ShinDengen
 New power. Your power.

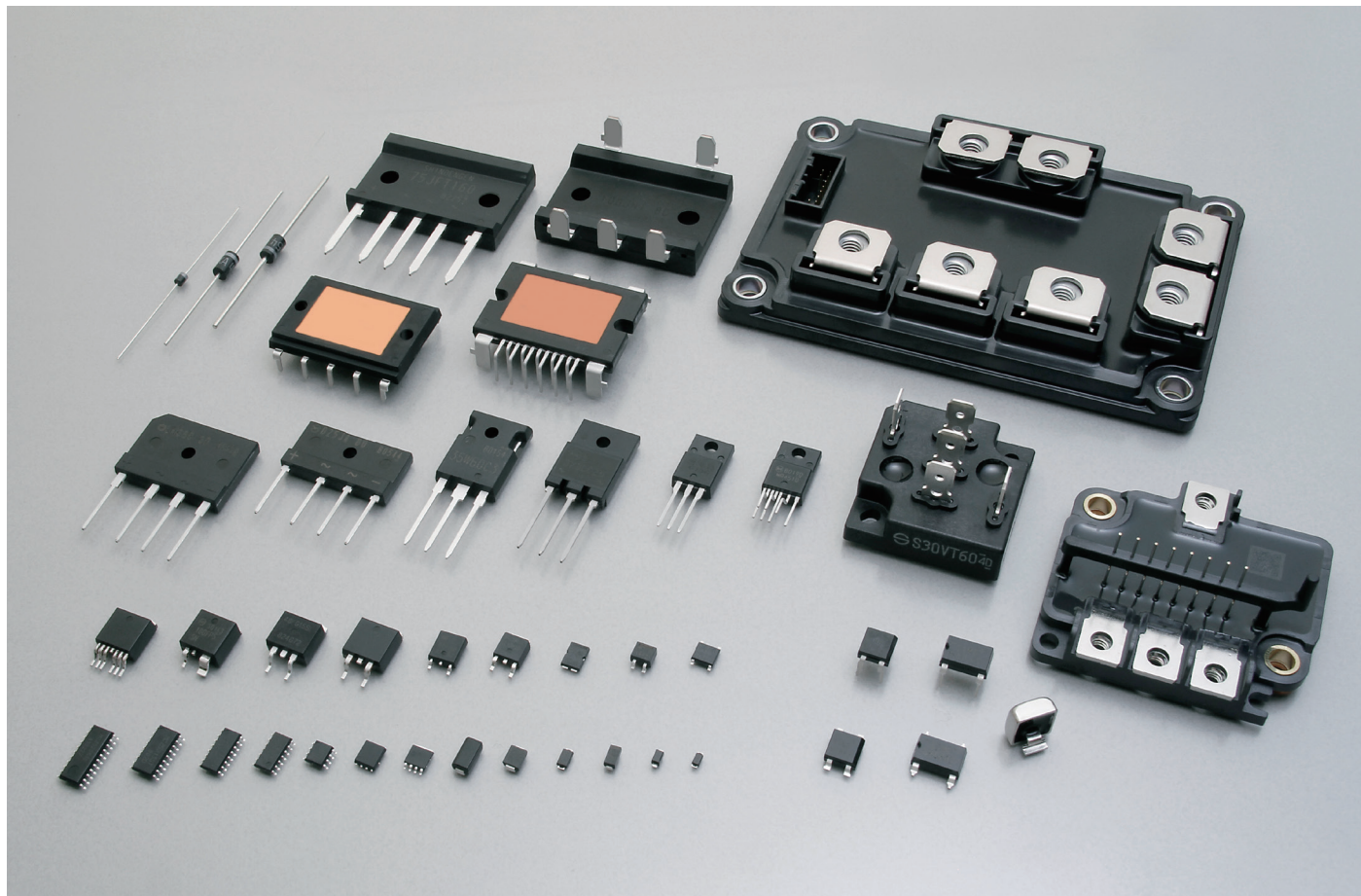

Notes

- ⚠ If you wish to use any such product, please be sure to refer to the specifications issued by Shindengen.
- ⚠ All products described or contained herein are designed with a quality level intended for use in standard applications requiring an ordinary level of reliability. If these products are to be used in equipment or devices for special or specific applications requiring an extremely high grade of quality or reliability in which failures or malfunctions of products may directly affect human life or health, a local Shindengen office must be contacted in advance to confirm that the intended use of the product is appropriate. Shindengen products are grouped into the following three applications according to the quality grade.
 - Standard applications
Computers, office automation and other office equipment, communication terminals, test and measurement equipment, audio/visual equipment, amusement equipment, consumer electronics, machine tools, personal electronic equipment, industrial equipment, etc.
 - Special applications
Transportation equipment (vehicles, ships, etc.), trunk-line communication equipment, traffic signal control systems, anti-disaster/crime systems, safety equipment, medical equipment, etc.
 - Specific applications
Nuclear reactor control systems, aircraft, aerospace equipment, submarine repeaters, life support equipment and systems, etc.
- ⚠ Although Shindengen continuously endeavors to enhance the quality and reliability of its products, customers are advised to consider and take safety measures in their design, such as redundancy, fire containment and anti-failure, so that personal injury, fires, or societal damages can be prevented.
- ⚠ Please note that all information described or contained herein is subject to change without notice due to product upgrades and other reasons. When buying Shindengen products, please contact the Company's offices or distributors to obtain the latest information.
- ⚠ Shindengen shall not bear any responsibility with regards to damages or infringement of any third-party patent rights and other intellectual property rights incurred due to the use of information on this website.
- ⚠ The information and materials on this website neither warrant the use of Shindengen's or any third party's patent rights and other intellectual property rights, nor grant license to such rights.
- ⚠ In the event that any product described or contained herein falls under the category of strategic products controlled under the Foreign Exchange and Foreign Trade Control Law of Japan, exporting of such products shall require an export license from the Japanese government in accordance with the above law.
- ⚠ No reprinting or reproduction of the materials on this website, either in whole or in part, is permitted without proper authorization from Shindengen.

SALES OFFICES

U.S.A.

Shindengen America, Inc. www.shindengen.com/

2333 Waukegan Road Suite250, Bannockburn, IL.60015. U.S.A
Phone:+1-847-444-1363 FAX:+1-847-444-0654

Europe

Shindengen UK Ltd. www.shindengen.co.eu/

Head Office

Unit 1, 1 Tapper Walk, King's Cross, London, N1C 4AQ U.K.
Phone:+44-20-3829-6980 FAX:+44-20-3725-6855

German Branch

Prinzenallee 1, 40549 Düsseldorf, Germany
Phone:+49-211-5206-590 FAX:+49-211-4986-499

Asia

Shindengen Singapore PTE Ltd.

750d, Chai Chee Road, #05-01,
Viva Business Park, Singapore 469004
Phone:+65-6445-0082 FAX:+65-6445-6089

Shindengen (H.K.) Co., Ltd.

Head Office

Suite 2006B, 20/F., Exchange Tower, 33 Wang Chiu Road,
Kowloon Bay, HK
Phone:+852-2317-1884 FAX:+852-2314-8561

Taiwan Representative Office

20FL, No.85, Sec.1, Jhongsiao E. Road, Taipei, 10049,
Taiwan, R.O.C.
Phone:+886-2-2321-3990 FAX:+886-2-2358-3991

Shindengen (SHANGHAI) Electric Co., Ltd.

Room1506, Sheng GaoInt'l Building, 137 Xian Xia Road,
Chang Ning, Shanghai, China
Phone:+86-21-6270-8000 FAX:+86-21-6270-0419

Shindengen Electric Mfg. Co., Ltd.

Seoul Office

B701-4. 230, Simin-daero, Dongan-gu, Anyang-si,
Gyeonggi-do, 14067 Korea
Phone:+82-31-385-1431 FAX:+82-31-385-1430

Japan

Shindengen Electric MFG. Co., Ltd. www.shindengen.co.jp/

Head Office

New-Ohtemachi Bldg., 2-2-1, Ohtemachi, Chiyoda-ku,
Tokyo 100-0004, Japan
Phone:+81-3-3279-4431 FAX:+81-3-3279-6478

Osaka Branch Office

Minami Senba Heart Bldg., 2-3-2, Minami-Senba,
Chuo-ku, Osaka City, Osaka 542-0081, Japan
Phone:+81-6-6264-7770 FAX:+81-6-6260-1222

Nagoya Branch Office

Nagoya Daiichi Bldg., 1-19-24, Nishiki, Naka-ku,
Nagoya City, Aichi 460-0003, Japan
Phone:+81-52-221-1361 FAX:+81-52-201-4780

Hamamatsu branch

Hamamatsu Daiichi Seimei Nittsu Bldg., 110-5, Itaya-cho,
Naka-ku, Hamamatsu City, Shizuoka 430-0928, Japan
Phone:+81-53-450-3800 FAX:+81-53-450-3801

















Utsunomiya Sales Office

Flora Bldg., 1-9-15 Higashi Syukugou Utsunomiya City,
Tochigi 321-0953, Japan
Phone:+81-28-637-3615 FAX:+81-28-637-3115

- All specifications are subject to change without notice.
- Please consult us for the latest specifications before you order.
- Please use this products after reading manual well.

• Printed January 2020

This catalog includes the products which might be subject to the foreign exchange and foreign trade laws.

P3-6	INDEX	
P7-10	GENERAL RECTIFYING DIODES	
P11-20	BRIDGE DIODES	
P21-30	SCHOTTKY BARRIER DIODES	
P31-36	FAST RECOVERY DIODES	
P37-38	THYRISTORS	
P39-40	SIDACs	
P41-42	TRIACs	
P43-44	SURGE ABSORBERS	
P45-48	TVS (Transient Surge Suppressor)	
P49-54	POWER MOSFETs	
P55-56	POWER MODULES	
P57-60	POWER ICs	
P61-82	PACKAGE LIST • OUTLINE DIMENSIONS	
P83-84	PACKING SPECIFICATION	
P85	NOTES •How to Order •Outline of Packing Form •About AEC-Q101 & Automotive Grade	

INDEX

Type No.	Page	Type No.	Page	Type No.	Page	Type No.	Page	Type No.	Page	Type No.	Page	Type No.	Page	Type No.	Page
D1F60	8	D3CE4S	22	D8JBB80V	14	D25JAB60V	14	DE5LC20U	34	DG1S6	22	KD8SF60	42	M3F60	8
D1F60A	8	D3CE6S	22	D10FDC10ST	26	D25JAB80V	14	DE5S4M	22	DG1S6A	22	KD12SF60	42	M3FE40	8
D1FE60	8	D3CE15ST	22	D10FR60LA	32			DE5S6M	22	DL04-18F1	46	KD16SF60	42	M3FE60	8
D1FH3	22	D3CE20LUS	32	D10FR60V	8			DE5SC3ML	26	DL04-33F1	46	KD20SF60	42	M3FL20U	32
D1FJ4	22	D3CE60K	32	D10FY4R5ST	22	D25XB60	14	DE5SC4M	26	DL04-36F1	46	KL3L07	44	MCZ5203SE	60
D1FJ8	22	D3CE60V	8	D10FY4R5SY	22	D25XB80	14	DE5SC6M	26	G1V(A)8C	40	KL3N14	44	MCZ5205SE	60
D1FJ8A	22	D3CE60VE	8	D10FY6ST	22	D25XB100	14	DE5VE40	8	G1V(A)10C	40	KL3R20	44	MCZ5207SG	60
D1FJ10	22	D3F60	8	D10FY6SY	22	D30FD60K	32	DE10S3L	22	G1V(A)12C	40	KL3Z07	44	MCZ5208SG	60
D1FK60	32	D3FE60	8	D10FY10ST	22	D30FDC4S	26	DE10SC3L	26	G1V(A)13C	40	KL3Z18	44	MCZ5209SN	60
D1FK70	32	D3FJ10	22	D10FY10SY	22	D30FDC10ST	26	DE10SC4	26	G1V(A)14C	40	KP20NU11	44	MCZ5211ST	60
D1FK100	32	D3FK60	32	D10FY15ST	22	D30FDC15ST	26	DF5VD60	10	G1V(A)15C	40	KP40NU11	44	MCZ5216ST	60
D1FK120	32	D3FS4A	22	D10FY60VE	8	D30JCB100K	18	DF8L60US	32	G1V(A)20C	40	KP40RU22	44	MCZ5303SG	60
D1FK120P	32	D3FS6	22	D10JBB60V	14	D30JCT120V	16	DF10L60	32	G1V(B)20C	40	KU4F8	44	MCZ5303SH	60
D1FL20U	32	D3S4M	24	D10JBB80V	14			DF10LC20U	34	G1V(B)22C	40	KU4F12	44	MCZ5601SC	60
D1FL40U	32	D3S6M	24	D10SBS4	18			DF10LC30	34	G1V(B)24C	40	KU5S31NS	44	MG020200	56
D1FM3	22	D3SB60	14	D10XB60	14	D30VC60	10	DF10NC15	26	G1VL8C	40	KU10L08	44	MG020201	56
D1FS4	22	D3SB80	14	D10XB60H	14	D30XBN20	18	DF10NC15	26	G1VL10C	40	KU10N14	44	MG031B090004A	56
D1FS4A	22	D3SBA60	14	D10XB80	14	D30XT80	16	DF10SC4M	26	G1VL15C	40	KU10NU11	44	MG031E120004A	56
D1FS6	22	D4F60	8	D15FR4ST	22	D35XB80	14	DF10SC6	26	G1VL20C	40	KU10NU13	44	MG031G148004A	56
D1FS6A	22	D4SB60L	14	D15FR60LA	32	D40FDC10ST	26	DF10SC9	26	G1VL22C	40	KU10R23NS	44	MG031L080006A	56
D1FT4	22	D4SB80	14	D15FR60V	8	D40FDC15ST	26	DF15JC10	26	G1VL24C	40	KU10R27NS	44	MG031MC148004A	56
D1FT4A	22	D4SBL20U	18	D15FY4R5ST	22	D45JCT120V	16	DF15NC15	26	K1V10	40	KU10R29NS	44	MG031MD110006A	56
D1FT6	22			D15FY4R5SY	22	D45JCT160V	16	DF15SC4M	26	K1V11	40	KU10S31NS	44	MG031N110006A	56
D1FT6A	22	D4SBN20	18	D15FY6ST	22	D45XT80	16	DF15VD60	10	K1V12	40	KU10S35NS	44	MG032A4207R5A	56
D1FT10	22	D4SBS4	18	D15FY6SY	22	D45XT160	16	DF16VC60R	10	K1V14	40	KU15N14	44	MG032B420010A	56
D1FT10A	22	D4SBS6	18	D15FY10ST	22	D50JCB80V	14	DF20JC10	26	K1V22	40	LL15XB60	20	MG038A200080A	18
D1FT15A	22	D5CE4S	22	D15FY10SY	22	D50XB80	14	DF20L60	32	K1V22(W)	40	LL25XB60	20	MG038B150080A	18
D1N60	8	D5FE60	8	D15FY15ST	22	D70JHB80V	14	DF20L60U	32	K1V24	40	LN1F60	8	MG038C200160A	18
D1N80	8	D5FY4R5ST	22	D15JAB60V	14	D75JFT80V	16	DF20LC20US	34	K1V24(W)	40	LN1WBA60	20	MG038D150160A	18
D1NF60	32	D5FY4R5SY	22	D15JAB80V	14	D100JHT80V	16	DF20LC30	34	K1V26	40	LN4SB60	20	MG048A150004A	56
D1NK60	32	D5FY6ST	22	D15XB60	14	D100JHT120V	16	DF20NC15	26	K1V26(W)	40	LN6SB60	20	MG048B100006A	56
D1NK100	32	D5FY6SY	22	D15XB60H	14	D100JHT160V	16	DF20SC4M	26	K1V36(W)	40	LN15XB60	20	MH2501SC	60
D1NL20U	32	D5FY10ST	22	D15XB80	14			DF20SC9M	26	K1V38(W)	40	LN15XB60H	20	MH2511SC	60
D1NL40U	32	D5FY10SY	22	D15XB100	14			DF25SC6M	26	K1V(A)10	40	LN25XB60	20	MS1003SH	60
D1NS4	24	D5FY15ST	22	D15XBN20	18	D120SC4M	30	DF25V60	8	K1V(A)11	40	M1F60	8	MS1004SH	60
D1NS6	24	D5FY60K	32	D15XBS6	18	D120SC6M	30	DF30JC4	26	K1V(A)12	40	M1F80	8	MS1005SK	60
D1UBA80	12	D5SB60	14	D20FD60LU	32	D180SC4M	30	DF30JC6	26	K1V(A)16	40	M1FE40	8	MS1006SK	60
D2F60	8	D5SB80	14	D20FDC10ST	26	D180SC6M	30	DF30JC10	26	K1VZL09	40	M1FE60	8	MS1007SH	60
D2FK60	32	D5SBA60	14	D20FDC15ST	26			DF30NC15	26	K1VZL20	40	M1FH3	22	MV1001SC	58
D2FL20U	32	D6FEC4ST	26	D20FDC20L	34			DF30SC3ML	26	KC3FB40H	38	M1FJ4	22	MV1002SC	58
D2FL40	32	D6FEC10ST	26	D20FDC20LUS	34	D240SC4M	30	DF30SC4M	26	KC5FB40H	38	M1FK60	32	MV1011SC	58
D2FS4	22	D6FEC12ST	26	D20FR4ST	22	D240SC6M	30	DF40SC3L	26	KC5FB60H	38	M1FL20U	32	MV1012SC	58
D2FS6	22	D6FEC15ST	26	D20FR4R5S	22	D360SC4M	30	DF40SC4	26	KC5FB60HR	38	M1FL40U	32	MV2002SG	58
D2L20U	32	D6JBB60V	14			D360SC6M	30	DG1H3	22	KC5FB60HRT	38	M1FM3	22	MV2052SG	58
D2L40U	32	D6JBB80V	14			DE3L20UA	32	DG1H3A	22	KC5SF60HRT	38	M1FS4	22	P0R5B60HP2	54
D2S4M	24	D6SB60L	14					DG1J10A	22	KC8SF80	38	M1FS6	22	P1B52HP2	54
D2S6M	24	D6SB80	14	D20XB60	14	DE3S4M	22	DG1M3	22	KD3FB60	42	M2F60	8	P1FE90VX3	54
D2SB60	14	D6SBN20	18	D20XB80	14	DE3S6M	22	DG1M3A	22	KD3SF60	42	M2FH3	22	P1R5B40HP2	54
D2SB60A	14	D8FD60LUS	32	D20XBS6	18	DE5L60A	32	DG1N15A	22	KD3SF60E	42	M2FL20U	32	P2B60HP2F	54
D2SBA60	14	D8JBB60V	14	D25FD60V	8	DE5L60U	32	DG1S4	22	KD5SF60	42	M2FM3	22	P2FE60VX5K	54

INDEX

INDEX

Type No.	Page	Type No.	Page	Type No.	Page	Type No.	Page	Type No.	Page	Type No.	Page	Type No.	Page	Type No.	Page
P2R5B52HP2F	54	P20FH50HP2	54	P50LF10SL	50	P105LF4QNK	50	S10VB60	16	SG30SC3LM	28	ST04-14F1	46		
P3B28HP2	54	P21F28HP2	54	P50LF10SLK	50	P126FP10SN	52	S10VT60	18	SG30SC4M	28	ST04-16F1	46		
P3F60HP2	54	P22F10SN	52	P50LF10SN	50	P126FP10SNK	52	S10VT80	18	S60SC4MT	28	ST04-18F1	46		
P3FH90VX3	54	P22FE4SBK	52	P50LF10SNK	50	P140LF4QL	50	S10VTA60	18	S60SC6MT	28	ST04-20F1	46		
P4B40HP2	54	P23F40HP2FM	54	P54B4SN	50	P140LF4QLK	50	S10VTA80	18	S90T15V	24	ST04-24F1	46		
P4B60HP2F	54	P23LA10SL	50	P55F6EN	52	P140LF4QN	50	S10WB60	16	SF3K60M	34	ST04-27F1	46		
P4F60HP2	54	P24B4SB	50	P56LA4SN	50	P140LF4QNK	50	S15VB60	16	SF3L60U	34	ST04-30F1	46		
P4F90VX3	54	P25B6EB	50	P60B4EL	50	P153FP6SN	52	S15VT60	18	SF5K60M	34	ST04-33F1	46		
P5B52HP2	54	P25LA12SL	50	P60B4SN	50	P153FP6SNK	52	S15VT80	18	SF5L40UM	34	ST04-36F1	46		
P5F50HP2	54	P25LF12SL	50	P60B6EL	50	P168FP7R5SN	52	S15VTA60	18	SF5L60U	34	ST04-39F1	46		
P5F50HP2F	54	P25LF12SLK	50	P60B6EN	50	P168FP7R5SNK	52	S15VTA80	18	SF5LC40UM	36	ST06-18CE	46		
P5F60HP2	54	P25LF12SN	50	P60B6SN	50	P175FP4SN	52	S15WB60	16	SF8K60M	34	ST06-27CE	46		
P5FH90VX3	54	P25LF12SNK	50	P64LF6QL	50	P175FP4SNK	52	S20K60T	34	SF8K60USM	34	ST06-30CE	46		
P6B28HP2	54	P26B10SL	50	P64LF6QLK	50	P180FP4SN	52	S20K100V	34	SF10K60M	34	ST06-33CE	46		
P6B40HP2	54	P26B10SN	50	P64LF6QN	50	P180FP4SNK	52	S20LC20UST	36	SF10KC60M	36	ST06-36CE	46		
P6B52HP2	54	P26F28HP2	54	P64LF6QNK	50	P180FP6SN	52	S20LC30T	36	SF10L60U	34	ST06-39CE	46		
P6F50HP2	54	P26FE10SLK	52	P66F7R5SN	52	P180FP6SNK	52	S20LC40UT	36	SF10L60MSM	34	ST20-27F2	46		
P6FE25VX5K	54	P30B10EL	50	P66F7R5SNK	52	P211FZ4QMKA	52	S20LC40UV	36	SF10L60MVM	34	ST20-30F2	46		
P7F60HP2	54	P30FE4SLK	52	P70F5EN	52	P240FZ4QLA	52	S20LC60UST	36	SF10LC40UM	36	ST20-33F2	46		
P7F90VX3	54	P30FE6SLK	52	P70F7R5EN	52	P240FZ4QNK	52	S20LC60USV	36	SF20K60M	34	ST20-36F2	46		
P7FH60HP2	54	P30FE7R5SLK	52	P70FP12SN	52	S1NAD80	10	S20SC9MT	28	SF20KC60M	36	ST20-47F2	46		
P8B10SB	50	P30LA10SL	50	P70FP12SNK	52	S1NB60	12	S20VT60	18	SF20L60U	34	ST60-40MF	46		
P8B28HP2	54	P30W60HP2V	54	P70LF4QLK	50	S1NB80	12	S20VT80	18	SF20L60MSM	34	ST60-48MF	46		
P8B30HP2	54	P32B12SN	50	P70LF4QNK	50	S1NBB80	12	S20VTA60	18	SF20L60MVM	34	ST70-27F	46		
P8F28HP2	54	P32F12SN	52	P72LF7R5SL	50	S1NBC60	12	S20VTA80	18	SF20LC30M	36	ST70-27FZ	46		
P8F50HP2	54	P32FG15SL	52	P72LF7R5SLK	50	S1NBC80	12	S20WB60	16	SG5L20USM	34	ST70-27MF	46		
P8FE10SBK	52	P32LF10SL	50	P72LF7R5SN	50	S1WB(A)60	12	S20WB80	16	SG5LC20USM	36	ST70-30MF	46		
P9B30HP2F	54	P32LF10SLK	50	P72LF7R5SNK	50	S1WB(A)60B	12	S25VB60	16	SG5S4M	24	ST80-14MF	46		
P9B40HP2	54	P32LF10SN	50	P80FG6EAL	52	S1WB(A)80	12	S25VB80	16	SG5S6M	24	UD2KB80	14		
P10B28HP2	54	P32LF10SNK	50	P80FG7R5EN	52	S1ZAS4	30	S30K60T	34	SG5S9M	24	UD3KB80	14		
P10F50HP2	54	P34F6EL	52	P80FH5ENK	52	S1ZB60	12	S30K60V	34	SG8SC4M	28	UD4KB80	14		
P10F60HP2	54	P36F28HP2	54	P82F7R5SN	52	S1ZB80	12	S30K100V	34	SG10L20USM	34	UD6KBA80	14		
P12F60HP2	54	P36FH28HP2	54	P85FG6EAL	52	S2K100	32	S30SC4MT	28	SG10LC20USM	36	UD8KBA80	14		
P12FE7R5SBK	52	P38LF6QLK	50	P85W28HP2F	54	S2L20U	32	S30SC6MT	28	SG10SC3LM	28	VR-61F1	44		
P13F28HP2	54	P38LF6QNK	50	P86F6SN	52	S2L40U	32	S30TC15T	28	SG10SC4M	28				
P13F50HP2	54	P40B10SL	50	P88FP10SN	52	S2L60	32	S30V60T	10	SG10SC6M	28				
P14FE6SBK	52	P40B10SN	50	P88FP10SNK	52	S2V60	8	S30V80V	10	SG10SC9M	28				
P15F50HP2	54	P40B6SL	50	P90FG5R5SL	52	S2V80	8	S30VT60	18	SG10TC15M	28				
P15F60HP2	54	P40F10SN	52	P94FG5R5SL	52	S2VB60	16	S30VT80	18	SG15SC4M	28				
P15F60HP2F	54	P40F12SN	52	P98LF6QL	50	S2WB(A)80	12	S30VT160	18	SG15SC6M	28				
P15FH60HP2	54	P40LF12SL	50	P98LF6QLK	50	S3K60	32	S30VTA60	18	SG20JC6M	28				
P15LA12SL	50	P40LF12SLK	50	P98LF6QN	50	S3L20U	32	S30VTA80	18	SG20LC20USM	36				
P16B6SB	50	P40LF12SN	50	P98LF6QNK	50	S3L40U	32	S30VTA160	18	SG20SC3LM	28				
P17F28HP2	54	P40LF12SNK	50	P100FA7R5EN	52	S3L60	32	S40HC1R5T	28	SG20SC4M	28				
P18LA12SL	50	P42F6EN	52	P100FH4ENK	52	S3V60	8	S40T15V	24	SG20SC6M	28				
P19LA10SL	50	P46LF7R5SL	50	P100FP12SN	52	S3V80	8	S50VB60	16	SG20SC9M	28				
P20B12SL	50	P46LF7R5SLK	50	P100FP12SNK	52	S3V100D	8	S50VB80	16	SG20TC10M	28				
P20B12SN	50	P46LF7R5SN	50	P105LF4QL	50	S3WB60	16	S60HC1R5T	28	SG20TC12M	28				
P20F50HP2	54	P46LF7R5SNK	50	P105LF4QLK	50	S4VB60	16	S60HC3T	28	SG20TC15M	28				
P20FE12SLK	52	P50F10SN	52	P105LF4QN	50	S5VB60	16	S60JC10V	28	SG30JC6M	28				











INDEX

GENERAL RECTIFYING DIODES



General Rectifying Diodes are defined as high-voltage and PN junction type devices.

These devices utilize our original glass passivation which is physically stable with a superior structure for resistance against heat and humidity. Variations are available for breakdown voltage up to 800V and output current from 1 to 30A.

Single

Surface Mount							
Package	JEDEC Code JEITA Code House Name	Fig.	I _{F(AV)} [A]	V _{RRM} [V]			Remarks
				400	600	800	
	DO-219AA similar M1F	B2	1		M1F60 M1FE60	M1F80	
			2	M1FE40			
	DO-214AC 1F	B3-1	1		D1F60 D1FE60		
			1.1		LN1F60		
			1.2		D1F60A		
	SC-110B CE	B5-1	3		D3CE60V		
			3.5		N D3CE60VE		① → ← ②
	DO-214AA similar M2F	B6	1.2		M2F60		
			3	M3FE40	M3F60 M3FE60		
		B9-1	1.4		D2F60		
			3		D3F60		
			4		D3FE60		
			5		D4F60		
					D5FE60		
	SC-63 E-pack	G1-5	5	DESVE40			① ④ ② ③ N.C.
	TO-277A similar FY	G4	10		D10FY60VE		① ② ③
	TO-252AA similar FR	G5	10		D10FR60V		① ② ④ ③
			15		D15FR60V		
	SC-83 similar STO-220	H1-2	25		DF25V60		① ② ④ ③
	SC-83 similar FD	H2-1	25		D25FD60V		① ② ④ ③

N : New product

Axial							
Package	JEDEC Code JEITA Code House Name	Fig.	I _{F(AV)} [A]	V _{RRM} [V]			Remarks
				400	600	800	
	AX057	A1	1		D1N60	D1N80	
	AX10	A5-1	1.7		S2V60	S2V80	① → ← ②
	AX14	A7	3			S3V100D	
			3.5		S3V60	S3V80	

Single

Surface Mount													
JEDEC Code JEITA Code House Name	Fig.	Type No.	Absolute Maximum Ratings					Electrical Characteristics				Based on AEC-Q101	Automotive
			I _{F(AV)} [A]	Conditions T _a [°C]	I _{FSM} [A]	V _{RRM} [V]	T _J [°C]	V _F (max) [V]	Conditions I _F [A]	I _R (max) V _R =V _{RRM} [μA]	V _{ESD} (typ) [kV]		
DO-219AA similar M1F	B2	M1F60	1	25	25	600	150	1.10	1	10	—	—	○
		M1FE60	1	129 *1	30	600	150	1.10	1	10	25	○	○
		M1F80	1	25	25	800	150	1.10	1	10	—	—	○
		M1FE40	2	103 *2	25	400	150	1.10	1	10	—	○	○
DO-214AC 1F	B3-1	D1F60	1	25	25	600	150	1.10	1	10	—	—	○
		D1FE60	1	126 *1	30	600	150	1.10	1	10	25	○	○
		LN1F60 *3	1.1	25	25	600	150	1.05	0.8	10	—	—	—
		D1F60A	1.2	25	45	600	150	0.97	1.2	10	—	—	○
SC-110B CE	B5-1	D3CE60V	3	101 *1	50	600	150	1.10	3	10	—	—	○
		N D3CE60VE	3.5	93 *1	60	600	-55 to 150	1.10	3.5	10	25	○	■
DO-214AA similar M2F	B6	M2F60	1.2	51	50	600	150	0.97	1.2	10	—	—	○
		M3FE40	3	76 *1	75	400	150	1.10	3	10	30	—	○
		M3F60	3	100 *1	90	600	150	1.05	3	10	—	—	○
		M3FE60	3	76 *1	90	600	150	1.05	3	10	25	○	○
2F	B9-1	D2F60	1.4	25	60	600	150	1.05	1.4	10	—	—	○
		D3F60	3	80 *1	150	600	150	1.05	3	10	—	—	○
		D3FE60	3	105 *1	150	600	150	1.05	3	10	25	○	○
		D4F60	4	68 *1	200	600	150	0.95	4	10	—	—	○
		D5FE60	5	82 *1	300	600	150	0.95	5	10	25	○	○
SC-63 E-pack	G1-5	DE5VE40	5	130 *2	80	400	150	1.00	5	10	30	—	■
TO-277A similar FY	G4	D10FY60VE	10	120 *1	220	600	-55 to 150	1.10	10	10	25	○	○
TO-252AA similar FR	G5	D10FR60V	10	130 *2	200	600	-55 to 150	1.05	10	10	—	—	■
		D15FR60V	15	125 *2	300	600	-55 to 150	1.05	15	10	—	—	■
SC-83 similar STO-220	H1-2	DF25V60	25	136 *2	400	600	150	1.10	25	10	—	—	—
SC-83 similar FD	H2-1	D25FD60V	25	113 *2	450	600	150	1.10	25	10	—	—	○

N : New product *1 : T_I *2 : T_C *3 : trr(max)=3.5μs ■ : Please contact us.

Axial													
JEDEC Code JEITA Code House Name	Fig.	Type No.	Absolute Maximum Ratings					Electrical Characteristics				Based on AEC-Q101	Automotive
			I _{F(AV)} [A]	Conditions T _a [°C]	I _{FSM} [A]	V _{RRM} [V]	T _J [°C]	V _F (max) [V]	Conditions I _F [A]	I _R (max) V _R =V _{RRM} [μA]	V _{ESD} (typ) [kV]		
AX057	A1	D1N60	1	25	30	600	150	1.05	1	10	—	—	—
		D1N80	1	25	30	800	150	1.05	1	10	—	—	—
AX10	A5-1	S2V60	1.7	40	60	600	150	1.05	1.7	10	—	—	—
		S2V80	1.7	40	60	800	150	1.05	1.7	10	—	—	—
AX14	A7	S3V100D	3	130 *1	150	800	150	1.05	3	10 *2	—	—	—
		S3V60	3.5	40	120	600	150	1.05	2.6	10	—	—	—
		S3V80	3.5	40	120	800	150	1.05	2.6	10	—	—	—

*1 : T_I *2 : V_R=1000V

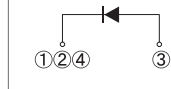

GENERAL RECTIFYING DIODES

Single

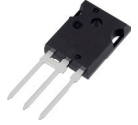
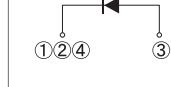
Two Terminal Type							
Package	JEDEC Code JEITA Code House Name	Fig.	I _{F(AV)} [A]	V _{RRM} [V]			Remarks
				400	600	800	
 41.0 × 16.0 × 5.0(mm)	TO-247AD - MTO-3PT	K2	30		S30V60T		

Three Terminal Type							
Package	JEDEC Code JEITA Code House Name	Fig.	I _{F(AV)} [A]	V _{RRM} [V]			Remarks
				400	600	800	
 41.0 × 16.0 × 5.0(mm)	TO-247AD - MTO-3PV	K6	30		S30V80V		

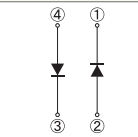
Array

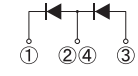
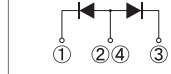
Surface Mount							
Package	JEDEC Code JEITA Code House Name	Fig.	I _{F(AV)} [A]	V _{RRM} [V]			Remarks
				400	600	800	
 10.0 × 6.8 × 2.6(mm)	- - 1NA	C6-2	3		S1NAD80		
 13.2 × 10.2 × 4.7(mm)	- - SC-83 similar STO-220	H1-5	5		DF5VD60		
			15		DF15VD60		
		H1-7	16		DF16VC60R		

Diode Module

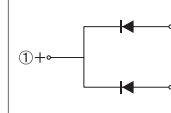
Package	JEDEC Code JEITA Code House Name	Fig.	I _{F(AV)} [A]	V _{RRM} [V]			Remarks
				400	600	800	
 22.3 × 22.3 × 25.0(mm)	- - D30VC	E2	30		D30VC60		

Single

Two Terminal Type													
Package			Absolute Maximum Ratings					Electrical Characteristics				Based on AEC-Q101	Automotive
JEDEC Code JEITA Code House Name	Fig.	Type No.	I _F (AV) [A]	Conditions T _C [°C]	I _{FSM} [A]	V _{RRM} [V]	T _J [°C]	V _F (max) [V]	Conditions I _F [A]	I _R (max) V _R =V _{RRM} [μA]	V _{ESD} (typ) [kV]		
TO-247AD - MTO-3PT	K2	S30V60T	30	119	360	600	150	1.1	30	10	-	-	-

Three Terminal Type													
Package			Absolute Maximum Ratings					Electrical Characteristics				Based on AEC-Q101	Automotive
JEDEC Code JEITA Code House Name	Fig.	Type No.	I _F (AV) [A]	Conditions T _C [°C]	I _{FSM} [A]	V _{RRM} [V]	T _J [°C]	V _F (max) [V]	Conditions I _F [A]	I _R (max) V _R =V _{RRM} [μA]	V _{ESD} (typ) [kV]		
TO-247AD - MTO-3PV	K6	S30V80V	30	131	450	800	150	1.1	30	10	-	-	○

Array

Surface Mount													
Package			Absolute Maximum Ratings					Electrical Characteristics				Based on AEC-Q101	Automotive
JEDEC Code JEITA Code House Name	Fig.	Type No.	I _F (AV) [A]	Conditions T _C [°C]	I _{FSM} [A]	V _{RRM} [V]	T _J [°C]	V _F (max) [V]	Conditions I _F [A]	I _R (max) V _R =V _{RRM} [μA]	V _{ESD} (typ) [kV]		
- - 1NA	C6-2	S1NAD80	3	102 *	110	800	150	1.05	0.75	10	-	-	-
- - SC-83 similar STO-220	H1-5	DF5VD60	5	140	140	600	150	1.05	2.50	10	-	-	-
		DF15VD60	15	127	190	600	150	1.05	7.50	10	-	-	-
	H1-7	DF16VC60R	16	124	190	600	150	1.05	8.00	10	-	-	-

* : Tl

Diode Module





Package			Absolute Maximum Ratings					Electrical Characteristics				Based on AEC-Q101	Automotive
JEDEC Code JEITA Code House Name	Fig.	Type No.	I _F (AV) [A]	Conditions T _C [°C]	I _{FSM} [A]	V _{RRM} [V]	T _J [°C]	V _F (max) [V]	Conditions I _F [A]	I _R (max) V _R =V _{RRM} [μA]	V _{ESD} (typ) [kV]		
- - D30VC	E2	D30VC60	30	124	300	600	150	1.05	15	10	-	-	-



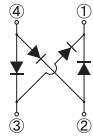

BRIDGE DIODES

Bridge Diodes are suitable for the rectification of commercial voltage.

Variations are available for various packaging as well as high voltage (Max 1600V), high IFSM, low VF, and low noise.

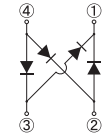
Small Bridge Diodes

Surface Mount							
Package	JEDEC Code JEITA Code House Name	Fig.	I _{F(AV)} [A]	V _{RRM} [V]			Remarks
				600	800	1000	
	TO-269AA	C2-1	0.8	S1ZB60	S1ZB80		
	1Z						
	SOPA-4	C1	1		D1UBA80		
		C4	1	S1NB60	S1NB80		
	1N						
		C6-1	1		S1NBB80		
	1NA		1.5	S1NBC60	S1NBC80		
		C8	1	S1WB(A)60 S1WB(A)60B	S1WB(A)80		
	1W		2		S2WB(A)80		

THD (Through Hole Device)							
Package	JEDEC Code JEITA Code House Name	Fig.	I _{F(AV)} [A]	V _{RRM} [V]			Remarks
				600	800	1000	
		C3	0.8	S1ZB60	S1ZB80		
	1Z						
		C5	1	S1NB60	S1NB80		
	1N						
		C7	1		S1NBB80		
	1NA		1.5	S1NBC60	S1NBC80		
		C9	1	S1WB(A)60 S1WB(A)60B	S1WB(A)80		
	1W		2		S2WB(A)80		

Small Bridge Diodes

Surface Mount													
Package		Type No.	Spec. Code	Absolute Maximum Ratings					Electrical Characteristics			UL	Automotive
JEDEC Code JEITA Code House Name	Fig.			I _{F(AV)} [A]	Conditions T _a [°C]	I _{FSM} [A]	V _{RRM} [V]	T _j [°C]	V _F (max) [V]	Conditions I _F [A]	I _r (max) V _R =V _{RRM} [μA]		
TO-269AA	C2-1	S1ZB60	-7072	0.8	25	30	600	150	1.05	0.4	10	-	-
1Z		S1ZB80	-7072	0.8	25	30	800	150	1.05	0.4	10	-	-
	C1	D1UBA80	-7062	1	25	30	800	150	0.95	0.4	10	-	-
	C4	S1NB60	-7062	1	25	30	600	150	1.05	0.5	10	-	-
1N		S1NB80	-7062	1	25	30	800	150	1.05	0.5	10	-	-
	C6-1	S1NBB80	-7062	1	26	50	800	150	1.05	0.5	10	-	-
		S1NBC60	-7062	1.5	105 *	60	600	150	1.05	0.75	10	-	-
1NA		S1NBC80	-7062	1.5	105 *	60	800	150	1.05	0.75	10	-	-
	C8	S1WB(A)60	-7062	1	25	30	600	150	1.00	0.5	10	-	-
		S1WB(A)60B	-7062	1	25	50	600	150	1.00	0.5	10	-	-
		S1WB(A)80	-7062	1	25	30	800	150	1.00	0.5	10	-	-
1W		S2WB(A)80	-7062	2	112 *	50	800	-40 to 150	1.05	1	10	-	-

* : TL









THD (Through Hole Device)													
Package		Type No.	Spec. Code	Absolute Maximum Ratings					Electrical Characteristics			UL	Automotive
JEDEC Code JEITA Code House Name	Fig.			I _{F(AV)} [A]	Conditions T _a [°C]	I _{FSM} [A]	V _{RRM} [V]	T _j [°C]	V _F (max) [V]	Conditions I _F [A]	I _r (max) V _R =V _{RRM} [μA]		
	C3	S1ZB60	-7101	0.8	25	30	600	150	1.05	0.4	10	-	-
1Z		S1ZB80	-7101	0.8	25	30	800	150	1.05	0.4	10	-	-
	C5	S1NB60	-7101	1	25	30	600	150	1.05	0.5	10	-	-
1N		S1NB80	-7101	1	25	30	800	150	1.05	0.5	10	-	-
	C7	S1NBB80	-7101	1	26	50	800	150	1.05	0.5	10	-	-
		S1NBC60	-7101	1.5	105 *	60	600	150	1.05	0.75	10	-	-
1NA		S1NBC80	-7101	1.5	105 *	60	800	150	1.05	0.75	10	-	-
	C9	S1WB(A)60	-7101	1	25	30	600	150	1.00	0.5	10	-	-
		S1WB(A)60B	-7101	1	25	50	600	150	1.00	0.5	10	-	-
		S1WB(A)80	-7101	1	25	30	800	150	1.00	0.5	10	-	-
1W		S2WB(A)80	-7101	2	112 *	50	800	-40 to 150	1.05	1	10	-	-

* : TL

BRIDGE DIODES

BRIDGE DIODES

SIP (Single In-line Package) Bridge Diodes

THD (Through Hole Device)							
Package	JEDEC Code JEITA Code House Name	Fig.	I _{F(AV)} [A]	V _{RRM} [V]			Remarks
				600	800	1000	
 24.0 × 13.8 × 3.1(mm)	— — D3K	D1	2		UD2KB80		
			3		UD3KB80		
			4		UD4KB80		
			6		UD6KBA80		
			8		UD8KBA80		
 24.5 × 20.0 × 3.5(mm)	— — 2S	D2	1.5	D2SBA60 D2SB60			
			2	D2SB60A			
 25.2 × 25.0 × 4.2(mm)	— — JB	D5	6	D6JBB60V	D6JBB80V		
			8	D8JBB60V	D8JBB80V		
			10	D10JBB60V	D10JBB80V		
 32.5 × 25.0 × 4.6(mm)	— — 3S	D3	4	D3SBA60 D3SB60 D4SB60L	D3SB80 D4SB80		
			10	D10XB60 D10XB60H	D10XB80		
 29.4 × 29.0 × 4.6(mm)	— — JA	D6	15	D15JAB60V	D15JAB80V		
			25	D25JAB60V	D25JAB80V		
 37.5 × 30.0 × 4.6(mm)	— — 5S	D4	6	D5SBA60 D5SB60 D6SB60L	D5SB80 D6SB80		
			15	D15XB60 D15XB60H	D15XB80	D15XB100	
			20	D20XB60	D20XB80		
			25	D25XB60	D25XB80	D25XB100	
 47.0 × 45.7 × 7.5(mm)	— — TSB(4pin)	D7	50		D50XB80		
			 47.0 × 45.7 × 7.5(mm)	— — JC(4pin)	50		

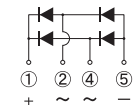
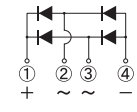

■ : New product

DIP (Dual In-line Package) Bridge Diode

Package	JEDEC Code JEITA Code House Name	Fig.	I _{F(AV)} [A]	V _{RRM} [V]			Remarks
				600	800	1000	
 47.0 × 45.7 × 7.5(mm)	— — JH	D10-1	70		D70JHB80V		

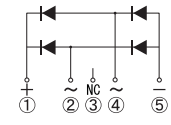

SIP (Single In-line Package) Bridge Diodes

THD (Through Hole Device)												
Package		Type No.	Absolute Maximum Ratings					Electrical Characteristics			UL	Automotive
JEDEC Code JEITA Code House Name	Fig.		I _F (AV) [A]	Conditions T _C [°C]	I _{FSM} [A]	V _{RRM} [V]	T _J [°C]	V _F (max) [V]	Conditions I _F [A]	I _R (max) V _R =V _{RRM} [μA]		
— — D3K	D1	UD2KB80	2	143	62	800	150	1.05	1	10	UL	—
		UD3KB80	3	140	90	800	150	1.05	1.5	10	UL	—
		UD4KB80	4	138	135	800	150	1.00	2	10	UL	—
		UD6KBA80	6	131	135	800	150	1.05	3	10	UL	—
		UD8KBA80	8	126	165	800	150	1.05	4	10	UL	—
— — 2S	D2	D2SBA60	1.5	25 *1	60	600	150	1.05	0.75	10	—	—
		D2SB60	1.5	25 *1	80	600	150	1.05	0.75	10	—	—
		D2SB60A	2	115 *2	120	600	150	0.95	1	10	—	—
— — JB	D5	D6JBB60V	6	131	100	600	150	1.05	3	10	UL	—
		D6JBB80V	6	131	100	800	150	1.05	3	10	UL	—
		D8JBB60V	8	130	130	600	150	1.05	4	10	UL	—
		D8JBB80V	8	130	130	800	150	1.05	4	10	UL	—
		D10JBB60V	10	129	150	600	150	1.05	5	10	UL	—
— — 3S	D3	D3SBA60	4	108	80	600	150	1.05	2	10	UL	—
		D3SB60	4	108	120	600	150	1.05	2	10	UL	—
		D4SB60L	4	111	150	600	150	0.95	2	10	UL	—
		D3SB80	4	108	120	800	150	1.05	2	10	UL	—
		D4SB80	4	108	150	800	150	0.95	2	10	UL	—
		D10XB60	10	100	120	600	150	1.10	5	10	UL	—
		D10XB60H	10	112	170	600	150	1.05	5	10	UL	—
		D10XB80	10	100	120	800	150	1.10	5	10	UL	—
		D15JAB60V	15	110	200	600	150	1.05	7.5	10	UL	—
		D15JAB80V	15	110	200	800	150	1.05	7.5	10	UL	—
— — JA	D6	D25JAB60V	25	107	350	600	150	1.05	12.5	10	UL	—
		D25JAB80V	25	107	350	800	150	1.05	12.5	10	UL	—
		D5SBA60	6	111	120	600	150	1.05	3	10	UL	—
		D5SB60	6	110	170	600	150	1.05	3	10	UL	—
		D6SB60L	6	112	170	600	150	1.05	3	10	UL	—
		D5SB80	6	110	170	800	150	1.05	3	10	UL	—
		D6SB80	6	110	170	800	150	1.05	3	10	UL	—
		D15XB60	15	100	200	600	150	1.10	7.5	10	UL	—
		D15XB60H	15	107	240	600	150	1.05	7.5	10	UL	—
		D15XB80	15	100	200	800	150	1.10	7.5	10	UL	—
		D15XB100	15	110	200	1000	150	1.10	7.5	10	UL	—
		D20XB60	20	87	240	600	150	1.10	10	10	UL	—
		D20XB80	20	87	240	800	150	1.10	10	10	UL	—
		D25XB60	25	98	350	600	150	1.05	12.5	10	UL	■
		D25XB80	25	98	350	800	150	1.05	12.5	10	UL	■
D25XB100	25	106	350	1000	150	1.05	12.5	10	UL	—		
■ D35XB80	35	93	550	800	-55 to 150	1.05	17.5	10	UL	—		
— — TSB(4pin)	D7	D50XB80	50	95	600	800	150	1.05	25	10	UL	—
		D50JCB80V	50	94	600	800	150	1.05	25	10	UL	■







■ : New product *1 : Ta *2 : Tl ■ : Please contact us. UL : UL recognized (UL File No. E142422)

DIP (Dual In-line Package) Bridge Diode

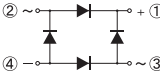



THD (Through Hole Device)												
Package		Type No.	Absolute Maximum Ratings					Electrical Characteristics			UL	Automotive
JEDEC Code JEITA Code House Name	Fig.		I _F (AV) [A]	Conditions T _C [°C]	I _{FSM} [A]	V _{RRM} [V]	T _J [°C]	V _F (max) [V]	Conditions I _F [A]	I _R (max) V _R =V _{RRM} [μA]		
— — JH	D10-1	D70JHB80V	70	99	500	800	-55 to 150	1.1	35	10	—	—

BRIDGE DIODES

SQIP (Square In-line Package) Bridge Diodes

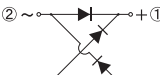



Package	JEDEC Code JEITA Code House Name	Fig.	I _{F(AV)} [A]	V _{RRM} [V]			Remarks
				600	800	1000	
 13.0 × 13.0 × 27.5(mm)	— S2VB	E3	2	S2VB60			
 17.0 × 17.0 × 32.5(mm)	— S4VB	E4	4	S4VB60			
 25.0 × 25.0 × 32.5(mm)	— S5VB	E5	6	S5VB60			
 22.0 × 22.0 × 32.5(mm)	— S10VB	E6	10	S10VB60			
 26.5 × 26.5 × 25.0(mm)	— S15VB	E7	15	S15VB60			
 32.0 × 32.0 × 25.0(mm)	— S25VB	E8	25	S25VB60	S25VB80		
 36.0 × 36.0 × 24.0(mm)	— S50VB	E9	50	S50VB60	S50VB80		

Input/Output In-line Terminal Type

Package	JEDEC Code JEITA Code House Name	Fig.	I _{F(AV)} [A]	V _{RRM} [V]			Remarks
				600	800	1000	
 17.0 × 17.0 × 31.0(mm)	— S3WB	E10	2.3	S3WB60			
 22.5 × 22.5 × 32.5(mm)	— S10WB	E11	10	S10WB60			
 26.5 × 26.5 × 32.5(mm)	— S15WB	E12	15	S15WB60			
 32.5 × 32.5 × 32.5(mm)	— S20WB	E13	20	S20WB60	S20WB80		

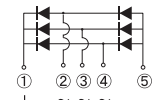
3 Phase Bridge Diodes

THD (Through Hole Device)

Package	JEDEC Code JEITA Code House Name	Fig.	I _{F(AV)} [A]	V _{RRM} [V]			Remarks
				800	1200	1600	
 47.0 × 45.7 × 7.5(mm)	— TSB(5pin)	D8	30	D30XT80			
			45	D45XT80		D45XT160	
 47.0 × 45.7 × 7.5(mm)	— JC(5pin)		30		D30JCT120V		
			45		D45JCT120V	D45JCT160V	
 47.0 × 45.7 × 7.5(mm)	— JF	D9	75	D75JFT80V			
 47.0 × 45.7 × 7.5(mm)	— JH	D10-2	100	D100JHT80V	D100JHT120V	 D100JHT160V	

 : New product

SQIP (Square In-line Package) Bridge Diodes

Package		Fig.	Type No.	Absolute Maximum Ratings				Electrical Characteristics			UL	Automotive
JEDEC Code JEITA Code House Name	I _{F(AV)} [A]			Conditions T _C [°C]	I _{FSM} [A]	V _{RRM} [V]	T _J [°C]	V _F (max) [V]	Conditions I _F [A]	I _R (max) V _R =V _{RRM} [μA]		
— S2VB	E3	S2VB60	2 *1	40	40	600	150	1.05	1	10	—	—
— S4VB	E4	S4VB60	4	40	80	600	150	1.05	2	10	—	—
— S5VB	E5	S5VB60	6	40	200	600	150	1.05	3	10	—	—
— S10VB	E6	S10VB60	10	40	200	600	150	1.05	5	10	—	—
— S15VB	E7	S15VB60	15	83 *2	200	600	150	1.05	7.5	10	—	—
— S25VB	E8	S25VB60	25	85 *2	400	600	150	1.05	12.5	10	—	—
— S25VB80		S25VB80	25	85 *2	400	800	150	1.05	12.5	10	—	—
— S50VB	E9	S50VB60	50	95 *2	500	600	150	1.05	25	10	—	—
— S50VB80		S50VB80	50	95 *2	500	800	150	1.05	25	10		—

*1 : Without heatsink *2 : T_C  : UL recognized (UL File No. E142422)











Input/Output In-line Terminal Type

Package		Fig.	Type No.	Absolute Maximum Ratings				Electrical Characteristics			UL	Automotive
JEDEC Code JEITA Code House Name	I _{F(AV)} [A]			Conditions T _C [°C]	I _{FSM} [A]	V _{RRM} [V]	T _J [°C]	V _F (max) [V]	Conditions I _F [A]	I _R (max) V _R =V _{RRM} [μA]		
— S3WB	E10	S3WB60	2.3	40 *	120	600	150	1.05	2	10	—	—
— S10WB	E11	S10WB60	10	74	170	600	150	1.05	5	10	—	—
— S15WB	E12	S15WB60	15	77	200	600	150	1.05	7.5	10	—	—
— S20WB	E13	S20WB60	20	76	500	600	150	1.05	10	10	—	—
— S20WB80		S20WB80	20	76	500	800	150	1.05	10	10		—

* : T_a  : UL recognized (UL File No. E142422)

3 Phase Bridge Diodes

THD (Through Hole Device)





Package		Fig.	Type No.	Absolute Maximum Ratings				Electrical Characteristics			UL	Automotive	
JEDEC Code JEITA Code House Name	I _{F(AV)} [A]			Conditions T _C [°C]	I _{FSM} [A]	V _{RRM} [V]	T _J [°C]	V _F (max) [V]	Conditions I _F [A]	I _R (max) V _R =V _{RRM} [μA]			
— TSB(5pin)	D8	D8	D30XT80	30	117	300	800	150	1.05	10	10		—
			D45XT80	45	101	400	800	150	1.05	15	10		—
			D45XT160	45	97	330	1600	150	1.05	15	100		—
			D30JCT120V	30	116	300	1200	150	1.05	10	10		—
			D45JCT120V	45	99	450	1200	150	1.05	15	10		—
— JC(5pin)	D8	D8	D45JCT160V	45	97	450	1600	150	1.05	15	10		—
			D9	D75JFT80V	75	109	400	800	150	1.05	25	10	—
— JH	D10-2	D10-2	D100JHT80V	100	99	500	800	-55 to 150	1.10	35	10		—
			D100JHT120V	100	92	450	1200	-55 to 150	1.17	35	10		—
			 D100JHT160V	100	92	540	1600	-55 to 150	1.15	35	10		—

 : New product  : UL recognized (UL File No. E142422)

BRIDGE DIODES

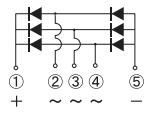

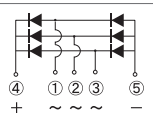
Series	Feature
S	Evenly balanced Vf and Ir
N	Low Vf, High Voltage
K	Low Vf

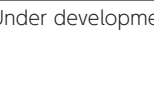
3 Phase Bridge Diodes

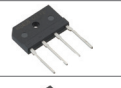
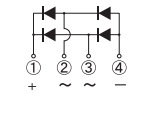
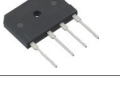

Package	JEDEC Code JEITA Code House Name	Fig.	If(AV) [A]	VRRM [V]			Remarks
				600	800	1600	
 36.0 × 36.0 × 24.0(mm)	-	SVT	E15	10	S10VT60	S10VT80	
				15	S15VT60	S15VT80	
				20	S20VT60	S20VT80	
				30	S30VT60	S30VT80	
 36.0 × 36.0 × 23.0(mm)	-	SVTA	E14	10	S10VTA60	S10VTA80	
				15	S15VTA60	S15VTA80	
				20	S20VTA60	S20VTA80	
				30	S30VTA60	S30VTA80	
 89.0 × 50.0 × 16.6(mm)	-	MG038	F7	150		MG038B150080A ★ MG038D150160A	
				200		MG038A200080A ★ MG038C200160A	

■ : New product ★ : Under development

High Speed Bridge Diodes (SBD)

THD (Through Hole Device)							
Package	JEDEC Code JEITA Code House Name	Fig.	If(AV) [A]	VRRM [V]			Remarks
				40	60	200	
 32.5 × 25.0 × 4.6(mm)	-	D3	4	D4SBS4	D4SBS6	D4SBN20	
			10	D10SBS4			
			15		D15XBS6		
 37.5 × 30.0 × 4.6(mm)	-	D4	6			D6SBN20	
			15			D15XBN20	
			20		D20XBS6		
			30			D30XBN20	

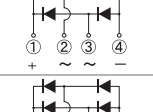
High Speed Bridge Diodes (FRD)

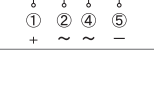
THD (Through Hole Device)							
Package	JEDEC Code JEITA Code House Name	Fig.	If(AV) [A]	VRRM [V]			Remarks
				200	400	1000	
 32.5 × 25.0 × 4.6(mm)	-	D3	4	D4SBL20U			
 47.0 × 45.7 × 7.5(mm)	-	D7	30			D30JCB100K	

3 Phase Bridge Diodes

Package		Type No.	Absolute Maximum Ratings					Electrical Characteristics			UL	Automotive
JEDEC Code JEITA Code House Name	Fig.		If (AV) [A]	Conditions Tc [°C]	IfSM [A]	VRRM [V]	Tj [°C]	Vf (max) [V]	Conditions If [A]	Ir (max) Vr=VRRM [μA]		
-	SVT	S10VT60	10	137	170	600	150	1.05	3.5	10	-	-
		S10VT80	10	137	150	800	150	1.05	3.5	10	-	-
		S15VT60	15	132	200	600	150	1.05	5	10	-	-
		S15VT80	15	132	200	800	150	1.05	5	10	-	-
		S20VT60	20	128	300	600	150	1.05	7	10	-	-
		S20VT80	20	128	300	800	150	1.05	7	10	-	-
		S30VT60	30	121	400	600	150	1.05	10	10	-	-
		S30VT80	30	121	400	800	150	1.05	10	10	UL	-
		S30VT160	30	116	350	1600	150	1.05	10	100	-	-
-	SVTA	S10VTA60	10	137	170	600	150	1.05	3.5	10	-	-
		S10VTA80	10	137	150	800	150	1.05	3.5	10	-	-
		S15VTA60	15	132	200	600	150	1.05	5	10	-	-
		S15VTA80	15	132	200	800	150	1.05	5	10	-	-
		S20VTA60	20	128	300	600	150	1.05	7	10	-	-
		S20VTA80	20	128	300	800	150	1.05	7	10	-	-
		S30VTA60	30	121	400	600	150	1.05	10	10	-	-
		S30VTA80	30	121	400	800	150	1.05	10	10	-	-
		S30VTA160	30	116	350	1600	150	1.05	10	100	-	-
-	MG038	MG038B150080A	150	125	2350	800	150	1.05	67	10	UL	-
		★ MG038D150160A	150	125	2350	1600	150	1.05	50	10	to be certified	-
		MG038A200080A	200	125	2750	800	150	1.05	67	10	UL	-
		★ MG038C200160A	200	125	2750	1600	150	1.05	50	10	to be certified	-

■ : New product ★ : Under development UL : UL recognized (UL File No. E142422)

High Speed Bridge Diodes (SBD)

THD (Through Hole Device)													
Package		Type No.	Absolute Maximum Ratings					Electrical Characteristics			UL	Automotive	Remarks
JEDEC Code JEITA Code House Name	Fig.		If (AV) [A]	Conditions Tc [°C]	IfSM [A]	VRRM [V]	Tj [°C]	Vf (max) [V]	Conditions If [A]	Ir (max) Vr=VRRM [μA]			
-	3S	D4SBS4	4	116	60	40	150	0.55	2	2mA	-	-	S series
		D4SBS6	4	114	60	60	150	0.62	2	2mA	-	-	S series
		D4SBN20	4	103	60	200	150	0.90	2	1.5	-	-	N series
		D10SBS4	10	67	100	40	150	0.55	5	3.5mA	-	-	S series
		D15XBS6	15	59	150	60	150	0.63	7.5	6.0mA	-	-	S series
-	5S	D6SBN20	6	110	120	200	150	0.90	3	2	-	-	N series
		D15XBN20	15	106	200	200	150	0.90	7.5	5	-	-	N series
		D20XBS6	20	100	200	60	150	0.63	10	8.0mA	-	-	S series
		D30XBN20	30	91	350	200	150	0.90	15	10	-	-	N series

High Speed Bridge Diodes (FRD)

THD (Through Hole Device)													
Package		Type No.	Absolute Maximum Ratings					Electrical Characteristics			UL	Automotive	Remarks
JEDEC Code JEITA Code House Name	Fig.		If (AV) [A]	Conditions Tc [°C]	IfSM [A]	VRRM [V]	Tj [°C]	Vf (max) [V]	Conditions If [A]	Ir (max) Vr=VRRM [μA]			
-	3S	D4SBL20U	4	108	80	200	150	0.98	2	10	-	-	
-	JC(4pin)	D30JCB100K	30	90	450	1000	150	1.90	15	10	UL	○	K series

UL : UL recognized (UL File No. E142422)

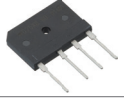
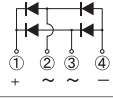

BRIDGE DIODES

Low Vf Bridge Diodes

THD (Through Hole Device)							
Package	JEDEC Code JEITA Code House Name	Fig.	If(AV) [A]	VRRM [V]			Remarks
				600	800	1000	
 37.5 × 30.0 × 4.6(mm)	— — 5S	D4	15	LL15XB60			
			25	LL25XB60			

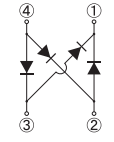
Low Noise Bridge Diodes

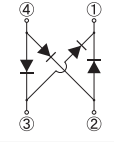
Surface Mount							
Package	JEDEC Code JEITA Code House Name	Fig.	If(AV) [A]	VRRM [V]			Remarks
				600	800	1000	
 10.6 × 10.2 × 3.1(mm)	— — 1W	C8	1.1	LN1WBA60			

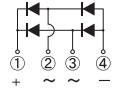
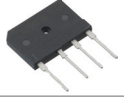
THD (Through Hole Device)							
Package	JEDEC Code JEITA Code House Name	Fig.	If(AV) [A]	VRRM [V]			Remarks
				600	800	1000	
 6.2 × 10.2 × 3.0(mm)	— — 1W	C9	1.1	LN1WBA60			
 32.5 × 25.0 × 4.6(mm)	— — 3S	D3	4	LN4SB60			
 37.5 × 30.0 × 4.6(mm)	— — 5S	D4	6	LN6SB60			
			15	LN15XB60 LN15XB60H			
			25	LN25XB60			

Low Vf Bridge Diodes

THD (Through Hole Device)													
Package		Type No.	Absolute Maximum Ratings					Electrical Characteristics				UL	Automotive
JEDEC Code JEITA Code House Name	Fig.		If (AV) [A]	Conditions Tc [°C]	IfSM [A]	VRRM [V]	Tj [°C]	Vf (max) [V]	Conditions If [A]	Ir (max) Vr=VRRM [μA]	trr (max) [μs]		
—	D4	LL15XB60	15	124	200	600	150	0.90	7.5	10	3	UL	—
5S		LL25XB60	25	113	300	600	150	0.92	12.5	10	3	UL	■

■ : Please contact us. UL : UL recognized (UL File No. E142422)

Low Noise Bridge Diodes

Surface Mount-THD (Through Hole Device)														
Package		Type No.	Absolute Maximum Ratings					Electrical Characteristics				UL	Automotive	Remarks
JEDEC Code JEITA Code House Name	Fig.		If (AV) [A]	Conditions Tc [°C]	IfSM [A]	VRRM [V]	Tj [°C]	Vf (max) [V]	Conditions If [A]	Ir (max) Vr=VRRM [μA]	trr (max) [μs]			
— — 1W	C8(SMD) C9(DIP)	LN1WBA60	1.1	25 *	50	600	150	1.00	0.55	10	5	—	—	SMD-7072 DIP-7101
— — 3S	D3	LN4SB60	4	111	150	600	150	0.95	2	10	5	UL	—	
— — 5S	D4	LN6SB60	6	111	170	600	150	1.05	3	10	5	UL	—	
		LN15XB60	15	100	200	600	150	1.10	7.5	10	5	—	—	
		LN15XB60H	15	106	290	600	150	1.05	7.5	10	5	—	—	
		LN25XB60	25	85	350	600	150	1.05	12.5	10	5	—	—	

* : Ta UL : UL recognized (UL File No. E142422)









BRIDGE DIODES

SCHOTTKY BARRIER DIODES

Schottky Barrier Diodes are diodes using a barrier at the junction of a metal and the semiconductor. These are very suitable rectification devices featuring high speed and a low Vf diode.

Series	Feature
S	Evenly balanced Vf and Ir
M	Evenly balanced Low Vf and Ir
N	High Voltage
H	Ultra Low Vf, Tj=125°C guaranteed
J	Low Ir
SL	Ultra Low Ir, Tj=175°C guaranteed
Y	Evenly balanced Vf and Low Ir

Single

Surface Mount											
Package	JEDEC Code JEITA Code House Name	Fig.	If (AV) [A]	VRRM[V]						Remarks	
				30	40	45	60	80	100	150	
	DO-219AB similar SC-109 G1F	B1-1	1	DG1M3 DG1H3	DG1S4		DG1S6		DG1J10A		① ← ②
			1.4					DG1N15A			
			1.5	DG1M3A DG1H3A		DG1S6A					
	DO-219AA similar M1F	B2	1.2				M1FS6				
			1.3		M1FS4						
			1.5		M1FJ4						
			1.7	M1FH3							
	DO-214AC 1F	B3-1	1						D1FJ10		
			1.1		D1FS4		D1FS6				
			1.5		D1FS4A						
			2		D1FT4 D1FJ4		D1FT6	D1FJ8	D1FT10		
			2.5				D1FS6A				
	SC-110B CE	B5-1	3		D3CE4S		D3CE6S			D3CE15ST	
			5		D5CE4S						
	DO-214AA similar M2F	B6	6	M2FH3 M2FM3							
	SC-63 E-pack	B9-1	1.5				D2FS6				
			1.6		D2FS4						
			2.6		D3FS4A						
	SC-63 E-pack	G1-2	3		DE3S4M		DE3S6M				②④ ③
			5		DE5S4M		DE5S6M				
	TO-277A similar FY	G4	5			D5FY4R5ST D5FY4R5SY	D5FY6ST D5FY6SY		D5FY10ST D5FY10SY	D5FY15ST	① ②③
			10		D10FY4R5ST D10FY4R5SY	D10FY6ST D10FY6SY		D10FY10ST D10FY10SY	D10FY15ST		
			15		D15FY4R5ST D15FY4R5SY	D15FY6ST D15FY6SY		D15FY10ST D15FY10SY	D15FY15ST		
	TO-252AA similar FR	G5	15		D15FR4ST						① ②④ ③
			20		D20FR4ST	N D20FR4R5S					





N : New product

Single

Surface Mount															
Package	JEDEC Code JEITA Code House Name	Fig.	Type No.	VRRM [V]	If (AV) [A]	Conditions Tc [°C]	IFSM [A]	Tj [°C]	Vf (max) [V]	Conditions If [A]	Ir (max) Vr=VRRM [mA]	Ct (typ) [pF]	Based on AEC-Q101	Automotive	Series
DO-219AB similar SC-109 G1F	B1-1		DG1M3	30	1	27 *1	20	150	0.46	0.7	0.05	36	○	○	M series
			DG1H3	30	1	113 *2	20	125	0.36	0.7	1	37	—	○	H series
			DG1S4	40	1	36 *1	30	150	0.55	0.7	0.8	37	○	○	S series
			DG1S6	60	1	128 *2	30	150	0.58	0.7	1	32	○	○	S series
			DG1J10A	100	1	125 *2	30	150	0.82	1	0.1	43	—	○	J series
			DG1N15A	150	1.4	65 *1	30	150	0.88	1.4	0.05	32	○	○	N series
			DG1M3A	30	1.5	37 *1	30	150	0.46	1.5	0.05	70	○	○	M series
			DG1H3A	30	1.5	107 *2	30	125	0.36	1.5	1	70	○	○	H series
DO-219AA similar M1F	B2		DG1S6A	60	1.5	122 *2	40	150	0.53	1	0.05	43	○	○	S series
			M1FS6	60	1.2	25 *1	40	150	0.58	1.1	1	53	○	○	S series
			M1FS4	40	1.33	25 *1	30	150	0.55	1.1	0.8	50	○	○	S series
			M1FJ4	40	1.5	31 *1	30	150	0.63	1.5	0.05	65	○	○	J series
DO-214AC 1F	B3-1		M1FH3	30	1.7	25 *1	30	-55 to 125	0.36	1.5	1	80	—	—	H series
			M1FM3	30	3	100	30	150	0.46	1.5	0.05	80	○	○	M series
			D1FJ10	100	1	52 *1	50	150	0.72	1	0.2	63	○	○	J series
			D1FS4	40	1.1	51 *1	30	150	0.55	1.1	1	65	○	○	S series
			D1FS6	60	1.1	38 *1	40	150	0.58	1.1	1	50	○	○	S series
			D1FS4A	40	1.5	28 *1	60	150	0.48	1.5	2	95	○	○	S series
			D1FT4	40	2	143 *2	60	175	0.74	2	5μA	63	○	○	SL series
			D1FJ4	40	2	117 *2	50	150	0.61	2	0.2	96	○	○	J series
			D1FT6	60	2	141 *2	60	175	0.78	2	5μA	53	○	○	SL series
			D1FJ8	80	2	110	30	150	0.74	1.5	0.2	40	—	○	Y series
			D1FT10	100	2	136 *2	50	175	0.86	2	5μA	40	○	○	SL series
			D1FS6A	60	2.5	103 *2	60	150	0.57	2.5	0.2	80	○	○	S series
			D1FH3	30	3	95	60	125	0.36	3	2	130	—	—	H series
			D1FT4A	40	3	127 *2	90	175	0.74	3	8μA	93	○	○	SL series
			D1FT6A	60	3	125 *2	90	175	0.78	3	8μA	78	○	○	SL series
			D1FJ8A	80	3	100	30	150	0.74	3	0.4	70	—	○	Y series
SC-110B CE	B5-1		D1FT10A	100	3	116 *2	60	175	0.86	3	8μA	60	○	○	SL series
			D1FT15A	150	3	116 *2	60	175	0.88	3	8μA	52	○	○	SL series
			D1FM3	30	5	83	90	150	0.46	3	0.1	130	○	○	M series
			D3CE4S	40	3	106 *2	80	150	0.52	3	0.3	97	—	○	S series
			D3CE6S	60	3	112 *2	100	150	0.58	3	0.3	110	○	○	S series
DO-214AA similar M2F	B6		D3CE15ST	150	3	136 *2	80	175	0.88	3	8μA	52	○	○	SL series
			D5CE4S	40	5	94 *2	120	-55 to 150	0.52	5	0.5	157	—	○	S series
SC-63 E-pack	B9-1		M2FH3	30	6	70	110	125	0.36	6	4	240	—	—	H series
			M2FM3	30	6	99	120	150	0.46	6	0.2	240	○	○	M series
			D2FS6	60	1.5	31 *1	60	150	0.58	2	2	120	—	○	S series
			D2FS4	40	1.6	34 *1	60	150	0.55	1.6	2.5	150	—	○	S series
TO-277A similar FY	G4		D3FS4A	40	2.6	34 *1	150	150	0.45	2.6	5	340	○	○	S series
			D3FS6	60	3	87 *2	80	150	0.58	3	2.5	130	—	○	S series
			D3FJ10	100	3	92 *2	100	150	0.74	3	0.4	143	—	○	J series
			DE3S4M	40	3	121	70	150	0.55	3	2.5	150	—	—	S series
			DE3S6M	60	3	117	80	150	0.58	3	2.5	130	—	—	S series
			DE5S4M	40	5	101	80	150	0.55	5	3.5	180	—	—	S series
			DE5S6M	60	5	96	90	150	0.58	5	4.5	200	—	—	S series
			DE10S3L	30	10	124	250	150	0.45	8	10	640	—	—	S series
TO-252AA similar FR	G5		D5FY4R5ST	45	5	165 *2	240	-55 to 175	0.74	5	15μA	187	○	○	SL series
			D5FY4R5SY	45	5	138 *2	220	-55 to 150	0.59	5	0.2	155	○	○	Y series
			D5FY6ST	60	5	164 *2	210	-55 to 175	0.78	5	15μA	148	○	○	SL series
			D5FY6SY	60	5	138 *2	210	-55 to 150	0.67	5	0.2	170	○	○	Y series
			D5FY10ST	100	5	162 *2	210	-55 to 175	0.86	5	15μA	104	○	○	SL series
			D5FY10SY	100	5	132 *2	130	-55 to 150	0.8	5	0.2	141	○	○	Y series
			D5FY15ST	150	5	162 *2	210	-55 to 175	0.88	5	15μA	92	○	○	SL series
			D10FY4R5ST	45	10	155 *2	250	-55 to 175	0.74	10	30μA	330	○	○	SL series
			D10FY4R5SY	45	10	126 *2	290	-55 to 150	0.59	10	0.4	302	○	○	Y series
			D10FY6ST	60	10	154 *2	230	-55 to 175	0.78	10	30μA	263	○	○	SL series
			D10FY6SY	60	10	127 *2	250	-55 to 150	0.67	10	0.4	262	○	○	Y series
			D10FY10ST	100	10	152 *2	230	-55 to 175	0.86	10	30μA	185	○	○	SL series
			D10FY10SY	100	10	118 *2	260	-55 to 150	0.8	10	0.4	253	○	○	Y series
			D10FY15ST	150	10	149 *2	230	-55 to 175	0.88	10	30μA	159	○	○	SL series
			D15FY4R5ST	45	15	145 *2	270	-55 to 175	0.74	15	40μA	398	○	○	SL series
			D15FY4R5SY	45	15	116 *2	310	-55 to 150	0.59	15	0.5	410	○	○	Y series
	D15FY6ST	60	15	143 *2	250	-55 to 175	0.78	15	40μA	345	○	○	SL series		
	D15FY6SY	60	15	117 *2	280	-55 to 150	0.67	15	0.5	345	○	○	Y series		
	D15FY10ST	100	15	141 *2	250	-55 to 175	0.86	15	40μA	242	○	○	SL series		
	D15FY10SY	100	15	114 *2	280	-55 to 150	0.83	15	0.5	297	○	○	Y series		
	D15FY15ST	150	15	138 *2	230	-55 to 175	0.88	15	40μA	209	○	○	SL series		
TO-252AA similar FR	G5		D15FR4ST	40	15	152	250	-55 to 175	0.74	15	40μA	398	○	■	SL series
			D20FR4ST	40	20	149	400	-55 to 175	0.74	20	60μA	600	○	■	SL series

SCHOTTKY BARRIER DIODES

Single

Axial						
Package	JEDEC Code JEITA Code House Name	Fig.	I _{F(AV)} [A]	V _{RRM} [V]		Remarks
				40	60	
 3.0 x φ 2.6(mm)	— AX057	A1	1	D1NS4	D1NS6	
 5.0 x φ 4.0(mm)	— AX078	A4-1	2	D2S4M	D2S6M	
 7.0 x φ 4.4(mm)	— AX14	A7	3	D3S4M	D3S6M	

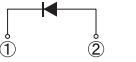
Two Terminal Type							
Package	JEDEC Code JEITA Code House Name	Fig.	I _{F(AV)} [A]	V _{RRM} [V]			Remarks
				40	60	90	
 28.5 x 10.0 x 4.5(mm)	— SC-91 FTO-220G	J4	5	SG5S4M	SG5S6M	SG5S9M	

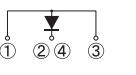
Three Terminal Type								
Package	JEDEC Code JEITA Code House Name	Fig.	I _{F(AV)} [A]	V _{RRM} [V]				Remarks
				40	60	90	150	
 41.0 x 16.0 x 5.0(mm)	TO-247AD — MTO-3PV	K7-2	40				S40T15V	
			90				S90T15V	

Single

Axial														
Package		Type No.	Absolute Maximum Ratings					Electrical Characteristics				Based on AEC-Q101	Automotive	Series
JEDEC Code JEITA Code House Name	Fig.		V _{RRM} [V]	I _{F(AV)} [A]	Conditions T _a [°C]	I _{FSM} [A]	T _J [°C]	V _F (max) [V]	Conditions I _F [A]	I _R (max) V _R =V _{RRM} [mA]	C _t (typ) [pF]			
—	A1	D1NS4	40	1	59	30	150	0.55	1	0.8	50	—	—	S series
AX057		D1NS6	60	1	46	30	150	0.58	1	1	53	—	—	S series
—	A4-1	D2S4M	40	2	122 *1	60	150	0.55	2	2	95	—	—	S series
AX078		D2S6M	60	2	119 *1	60	150	0.58	2	2	90	—	—	S series
—	A7	D3S4M	40	3	63	80	150	0.55	3	3.5	150	—	—	S series
AX14		D3S6M	60	3	133 *1	80	150	0.58	3	2.5	130	—	—	S series

*1 : T_J





Two Terminal Type														
Package		Type No.	Absolute Maximum Ratings					Electrical Characteristics				Based on AEC-Q101	Automotive	Series
JEDEC Code JEITA Code House Name	Fig.		V _{RRM} [V]	I _{F(AV)} [A]	Conditions T _c [°C]	I _{FSM} [A]	T _J [°C]	V _F (max) [V]	Conditions I _F [A]	I _R (max) V _R =V _{RRM} [mA]	C _t (typ) [pF]			
—	J4	SG5S4M	40	5	131	150	150	0.52	5	0.5	157	—	—	S series
SC-91		SG5S6M	60	5	130	120	150	0.56	5	0.5	165	—	—	S series
FTO-220G		SG5S9M	90	5	124	90	150	0.75	5	0.5	140	—	—	S series

Three Terminal Type														
Package		Type No.	Absolute Maximum Ratings					Electrical Characteristics				Based on AEC-Q101	Automotive	Series
JEDEC Code JEITA Code House Name	Fig.		V _{RRM} [V]	I _{F(AV)} [A]	Conditions T _c [°C]	I _{FSM} [A]	T _J [°C]	V _F (max) [V]	Conditions I _F [A]	I _R (max) V _R =V _{RRM} [mA]	C _t (typ) [pF]			
TO-247AD	K7-2	S40T15V	150	40	131	700	150	0.92	40	0.12	595	—	○	N series
MTO-3PV		S90T15V	150	90	122	1400	150	0.95	90	0.35	1690	—	○	N series

SCHOTTKY BARRIER DIODES

SCHOTTKY BARRIER DIODES

Center Tap, Common Cathode

Surface Mount											
Package	JEDEC Code JEITA Code House Name	Fig.	IF (AV) [A]	VRRM[V]						Remarks	
				30	40	60	90	100	120	150	
 9.5 × 6.6 × 2.65(mm)	— SC-63 E-pack	G1-1	5	DE5SC3ML	DE5SC4M	DE5SC6M					
			10	DE10SC3L	DE10SC4						
 9.5 × 6.6 × 2.65(mm)	TO-252AB similar SC-63 FE	G3-1	6		D6FEC4ST			D6FEC10ST	D6FEC12ST	D6FEC15ST	
			10		DF10SC4M	DF10SC6	DF10SC9			DF10NC15	
 13.2 × 10.2 × 4.7(mm)	— SC-83 similar STO-220	H1-1	15		DF15SC4M			DF15JC10		DF15NC15	
			20		DF20SC4M			DF20JC10		DF20NC15	
			25			DF25SC6M					
			30	DF30SC3ML	DF30JC4 DF30SC4M	DF30JC6		DF30JC10		DF30NC15	
 13.2 × 10.2 × 4.6(mm)	— SC-83 similar FD	H2-2	10					D10FDC10ST			
			20					D20FDC10ST		D20FDC15ST	
			30		D30FDC4S			D30FDC10ST		D30FDC15ST	
			40					D40FDC10ST		D40FDC15ST	

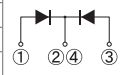

Center Tap, Common Cathode





Surface Mount														
Package		Type No.	Absolute Maximum Ratings					Electrical Characteristics				Based on AEC-Q101	Automotive	Series
JEDEC Code JEITA Code House Name	Fig.		VRRM	IF (AV)	Conditions Tc	IFSM	Tj	Vf (max)	Conditions If	Ir (max) Vr=VRRM	Ct (typ)			
			[V]	[A]	[°C]	[A]	[°C]	[V]	[A]	[mV]	[pF]			
— SC-63 E-pack	G1-1	DE5SC3ML	30	5	110	90	150	0.45	2.5	3.5	190	—	■	S series
		DE5SC4M	40	5	101	80	150	0.55	2.5	3.5	150	—	■	S series
		DE5SC6M	60	5	92	80	150	0.58	2.5	2.5	130	—	■	S series
		DE10SC3L	30	10	124	100	150	0.45	4	5	290	—	■	S series
		DE10SC4	40	10	132	100	150	0.55	5	3.5	210	—	■	S series
TO-252AB similar SC-63 FE	G3-1	D6FEC4ST	40	6	158	90	175	0.74	3	8μA	93	○	○	SL series
		D6FEC10ST	100	6	154	100	175	0.86	3	8μA	60	○	○	SL series
		D6FEC12ST	120	6	154	100	175	0.87	3	8μA	60	○	○	SL series
		D6FEC15ST	150	6	154	100	175	0.88	3	8μA	52	○	○	SL series
		DF10SC4M	40	10	125	100	150	0.55	5	3.5	180	—	—	S series
— SC-83 similar STO-220	H1-1	DF10SC6	60	10	132	150	150	0.58	5	4.5	260	—	—	S series
		DF10SC9	90	10	131	150	150	0.75	5	3	185	—	—	S series
		DF10NC15	150	10	123	100	150	0.88	5	0.2	110	—	—	N series
		DF15SC4M	40	15	129	150	150	0.55	7.5	5	340	—	—	S series
		DF15JC10	100	15	126	150	150	0.86	7.5	0.6	200	—	—	J series
		DF15NC15	150	15	126	150	150	0.88	7.5	0.3	155	—	—	N series
		DF20SC4M	40	20	122	230	150	0.55	10	7.5	390	—	—	S series
		DF20SC9M	90	20	111	200	150	0.75	10	10	370	—	—	S series
		DF20JC10	100	20	121	200	150	0.86	10	0.7	260	—	—	J series
		DF20NC15	150	20	121	200	150	0.88	10	0.4	200	—	—	N series
		DF25SC6M	60	25	115	300	150	0.58	12.5	10	490	—	—	S series
		DF30SC3ML	30	30	119	350	150	0.48	15	10	820	—	—	S series
		DF30JC4	40	30	115	250	150	0.61	15	0.7	560	—	—	J series
		DF30SC4M	40	30	112	360	150	0.55	15	10	590	—	—	S series
		DF30JC6	60	30	108	250	150	0.69	15	0.7	490	—	—	J series
		DF30JC10	100	30	116	300	150	0.86	15	1	390	—	—	J series
		DF30NC15	150	30	115	300	150	0.88	15	0.5	300	—	—	N series
		DF40SC3L	30	40	112	400	150	0.45	15	17	1200	—	—	S series
		DF40SC4	40	40	106	350	150	0.55	20	14	860	—	—	S series
		— SC-83 similar FD	H2-2	D10FDC10ST	100	10	158	150	175	0.86	5	15μA	104	○
D20FDC10ST	100			20	119	250	150	0.86	10	30μA	185	○	○	N series
D20FDC15ST	150			20	118	250	150	0.88	10	30μA	159	—	○	N series
D30FDC4S	40			30	114	300	150	0.55	15	1.5	415	○	○	S series
D30FDC10ST	100			30	108	300	150	0.86	15	40μA	242	—	○	N series
D30FDC15ST	150			30	107	300	150	0.88	15	40μA	209	—	○	N series
D40FDC10ST	100			40	105	400	150	0.86	20	60μA	360	—	○	N series
D40FDC15ST	150			40	103	400	150	0.88	20	60μA	315	—	○	N series

■ : Please contact us.

SCHOTTKY BARRIER DIODES

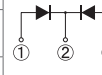
SCHOTTKY BARRIER DIODES

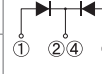
Center Tap, Common Cathode

Three Terminal Type														
Package	JEDEC Code JEITA Code House Name	Fig.	IF (AV) [A]	VRRM[V]								Remarks		
				15	30	40	60	90	100	120	150	600		
 28.5 × 10.0 × 4.5(mm)	SC-91 FTO-220G	J9	8			SG8SC4M								
			10		SG10SC3LM	SG10SC4M	SG10SC6M	SG10SC9M				SG10TC15M		
			15		SG15SC4M	SG15SC6M								
			20		SG20SC3LM	SG20SC4M	SG20JC6M SG20SC6M	SG20SC9M	SG20TC10M	SG20TC12M	SG20TC15M			
			30		SG30SC3LM	SG30SC4M	SG30JC6M SG30SC6M		SG30TC10M	SG30TC12M	SG30TC15M			
			40						SG40TC10M	SG40TC12M				
 41.0 × 16.0 × 5.0(mm)	TO-247AD MTO-3PT	K5-2	20					S20SC9MT						
			30			S30SC4MT	S30SC6MT				S30TC15T			
			40	S40HC1R5T										
 41.0 × 16.0 × 5.0(mm)	TO-247AD MTO-3PV	K7-1	60								S60JC10V			
				S60HC1R5T	S60HC3T S60SC3LT	S60SC4MT	S60SC6MT							

Center Tap, Common Cathode

Three Terminal Type														
JEDEC Code JEITA Code House Name	Fig.	Type No.	VRRM [V]	IF (AV) [A]	Conditions Tc [°C]	IFSM [A]	Tj [°C]	Vf (max) [V]	Conditions If [A]	Ir (max) Vr=VRRM [mA]	Ct (typ) [pF]	Based on AEC-Q101	Automotive	Series
SC-91 FTO-220G	J9	SG8SC4M	40	8	155	80	175	0.56	4.0	0.3	100	-	-	S series
		SG10SC3LM	30	10	136	150	150	0.45	4.0	5	310	-	-	S series
		SG10SC4M	40	10	150	150	175	0.52	5.0	0.5	157	-	-	S series
		SG10SC6M	60	10	145	140	175	0.56	5.0	0.5	165	-	-	S series
		SG10SC9M	90	10	139	150	175	0.75	5.0	0.5	140	-	-	S series
		SG10TC15M	150	10	153	120	175	0.88	5.0	15μA	92	-	-	SL series
		SG15SC4M	40	15	117	150	150	0.52	7.5	0.8	230	-	-	S series
		SG15SC6M	60	15	113	180	150	0.61	7.5	0.6	185	-	-	S series
		SG20SC3LM	30	20	124	250	150	0.45	8.0	9	570	-	-	S series
		SG20SC4M	40	20	115	200	150	0.52	10.0	1.1	315	-	-	S series
		SG20JC6M	60	20	106	200	150	0.69	10.0	0.1	250	-	-	J series
		SG20SC6M	60	20	107	200	150	0.61	10.0	0.8	250	-	-	S series
		SG20SC9M	90	20	112	200	150	0.75	10.0	1	245	-	-	S series
		SG20TC10M	100	20	140	200	175	0.86	10.0	30μA	185	-	-	SL series
		SG20TC12M	120	20	137	200	175	0.87	10.0	30μA	175	-	-	SL series
		SG20TC15M	150	20	136	200	175	0.88	10.0	30μA	159	-	-	SL series
		SG30SC3LM	30	30	117	350	150	0.45	12.5	15	960	-	-	M series
		SG30SC4M	40	30	101	300	150	0.55	15.0	1.5	415	-	-	S series
		SG30JC6M	60	30	90	250	150	0.69	15.0	0.15	325	-	-	J series
		SG30SC6M	60	30	100	300	150	0.61	15.0	1.2	385	-	-	S series
		SG30TC10M	100	30	126	300	175	0.86	15.0	40μA	242	-	-	SL series
		SG30TC12M	120	30	122	300	175	0.87	15.0	40μA	228	-	-	SL series
		SG30TC15M	150	30	122	300	175	0.88	15.0	40μA	209	-	-	SL series
		SG40TC10M	100	40	116	350	175	0.86	20.0	60μA	362	-	-	SL series
		SG40TC12M	120	40	112	350	175	0.87	20.0	60μA	336	-	-	SL series
		S20SC9MT	90	20	136	200	150	0.75	10.0	1	245	-	-	S series
		S30SC4MT	40	30	132	300	150	0.55	15.0	1.5	410	-	-	S series
		S30SC6MT	60	30	129	300	150	0.61	15.0	1.2	385	-	-	S series
		S30TC15T	150	30	128	300	150	0.88	15.0	40μA	209	-	-	N series
		S40HC1R5T	15	40	111	450	125	0.41	20.0	10	960	-	-	H series
S60HC1R5T	15	60	110	600	125	0.41	30.0	15	1400	-	-	H series		
S60HC3T	30	60	112	650	125	0.40	30.0	20	1100	-	-	H series		
S60SC3LT	30	60	138	650	150	0.48	30.0	25	1600	-	-	S series		
S60SC4MT	40	60	127	500	150	0.55	30.0	3	790	-	-	S series		
S60SC6MT	60	60	121	470	150	0.67	30.0	2	640	-	-	S series		
TO-247AD MTO-3PV	K7-1	S60JC10V	100	60	118	500	150	0.95	30.0	0.2	695	-	○	J series



SCHOTTKY BARRIER DIODES

SCHOTTKY BARRIER DIODES

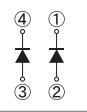
Array

Surface Mount						
Package	JEDEC Code JEITA Code House Name	Fig.	I _{F(AV)} [A]	V _{RRM} [V]		Remarks
				40	60	
 7.0 × 4.7 × 2.6(mm)	TO-269AA - 1Z	C2-2	1.2	S1ZAS4		

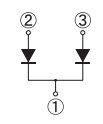
Diode Module

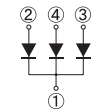
Surface Mount						
Package	JEDEC Code JEITA Code House Name	Fig.	I _{F(AV)} [A]	V _{RRM} [V]		Remarks
				40	60	
 43.0 × 27.0 × 21.0(mm)	- - Module	F1	120	D120SC4M	D120SC6M	
240			D240SC4M	D240SC6M		
 43.0 × 27.0 × 21.0(mm)		F3-1	180	D180SC4M	D180SC6M	
360			D360SC4M	D360SC6M		

Array

Surface Mount														
Package		Type No.	Absolute Maximum Ratings					Electrical Characteristics				Based on AEC-Q101	Automotive	Series
JEDEC Code JEITA Code House Name	Fig.		V _{RRM} [V]	I _{F(AV)} [A]	Conditions T _a [°C]	I _{FSM} [A]	T _J [°C]	V _F (max) [V]	Conditions I _F [A]	I _R (max) V _R =V _{RRM} [mA]	C _t (typ) [pF]			
TO-269AA - 1Z	C2-2	S1ZAS4	40	1.2	47	40	150	0.55	1	1	65	-	-	S series

Diode Module

Surface Mount														
Package		Type No.	Absolute Maximum Ratings					Electrical Characteristics				Based on AEC-Q101	Automotive	Series
JEDEC Code JEITA Code House Name	Fig.		V _{RRM} [V]	I _{F(AV)} [A]	Conditions T _c [°C]	I _{FSM} [A]	T _J [°C]	V _F (max) [V]	Conditions I _F [A]	I _R (max) V _R =V _{RRM} [mA]	C _t (typ) [pF]			
- - Module	F1	D120SC4M	40	120	90	800	125	0.58	60	40	2.1	-	-	S series
		D120SC6M	60	120	85	800	125	0.67	60	40	2.2	-	-	S series
		D240SC4M	40	240	77	1600	125	0.6	120	80	4.2	-	-	S series
		D240SC6M	60	240	71	1600	125	0.67	120	80	4.4	-	-	S series
	F3-1	D180SC4M	40	180	83	800	125	0.58	60	40	2.1	-	-	S series
		D180SC6M	60	180	78	800	125	0.67	60	40	2.2	-	-	S series
		D360SC4M	40	360	64	1600	125	0.6	120	80	4.2	-	-	S series
		D360SC6M	60	360	58	1600	125	0.67	120	80	4.4	-	-	S series

SCHOTTKY BARRIER DIODES



FAST RECOVERY DIODES

Fast Recovery Diodes are high speed type PN junction rectifying devices.



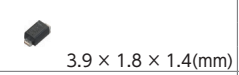

These diodes for the switching of power supply are suitable for use in household appliances, OA apparatuses, and FA apparatuses.

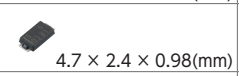
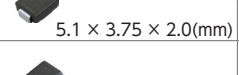
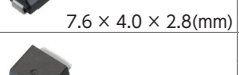
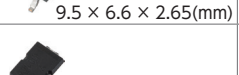
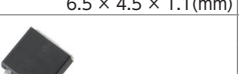
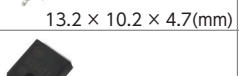
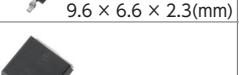
Series	Feature
K	Low Vf
ML	Low Vf, Low trr, Soft Recovery
US	Ultra Fast, Soft Recovery
A	Ultra Fast, Low Vf

Single

Surface Mount											
Package	JEDEC Code JEITA Code House Name	Fig.	If (AV) [A]	VRRM[V]						Remarks	
				200	400	600	700	1000	1200		
	DO-219AA similar M1F	B2	1			M1FK60					
			1.1	M1FL20U							
			1.5	M1FL40U							
	DO-214AC 1F	B3-1	0.8			D1FK60	D1FK70				
			1					D1FK100	D1FK120P D1FK120		
			1.1	D1FL20U							
	SC-110B CE	B5-1	3	D3CE20LUS		D3CE60K					① ← → ②
			1.5	M2FL20U							
			3	M3FL20U							
	DO-214AA similar M2F	B6	1.3		D2FL40						
			1.5	D2FL20U		D2FK60					
			2.1			D3FK60					
	SC-63 E-pack	G1-5	3	DE3L20UA							① ④ ② ③ N.C.
			5			DE5L60U DE5L60A					
	TO-277A similar FY	G4	5			D5FY60K					① ② ③
	SC-83 similar STO-220	H1-2	8			DF8L60US					① ② ④ ③
			10			DF10L60					
			20			DF20L60 DF20L60U					
	TO-252AA similar FR	G5	10			D10FR60LA					① ② ④ ③
			15			D15FR60LA					
	SC-83 similar FD	H2-1	8			D8FD60LUS					① ② ④ ③
			20			D20FD60LU					
			30			D30FD60K					

■ : New product

Axial											
Package	JEDEC Code JEITA Code House Name	Fig.	If (AV) [A]	VRRM[V]						Remarks	
				200	400	600	700	1000			
	AX057	A1	0.8			D1NF60 D1NK60					
			1	D1NL20U	D1NL40U				D1NK100		
	AX078	A4-1	1.5	D2L20U							① ← → ②
			2		D2L40U						
	AX10	A5-1	1.5	S2L20U		S2L60					
			2		S2L40U					S2K100	
	AX14	A7	2.2			S3L60					
			3	S3L20U	S3L40U	S3K60					

FAST RECOVERY DIODES

Single

Surface Mount															
JEDEC Code JEITA Code House Name	Fig.	Type No.	Absolute Maximum Ratings					Electrical Characteristics					Based on AEC-Q101	Automotive	Series
			VRRM [V]	If (AV) [A]	Conditions Tc [°C]	IfSM [A]	Tj [°C]	Vf (max) [V]	Conditions If [A]	Ir (max) Vr=VRRM [μA]	trr (max) [ns]				
DO-219AA similar M1F	B2	M1FK60	600	1	116 *1	15	150	1.5	1	10	75	—	○	K series	
		M1FL20U	200	1.1	25 *2	30	150	0.98	1.1	10	35	○	○	—	
		M1FL40U	400	1.5	139	30	175	1.2	1	10	25	■	○	—	
DO-214AC 1F	B3-1	D1FK60	600	0.8	29 *2	20	150	1.3	0.8	10	75	○	○	K series	
		D1FK70	700	0.8	32 *2	25	150	1.3	0.8	10	400	○	○	—	
		D1FK100	1000	1	97 *1	20	150	2.1	1	10	75	○	○	K series	
		D1FK120P	1200	1	79 *1	18	-55 to 150	3.0	1	10	85	○	■	K series	
		D1FK120	1200	1	75 *1	20	150	3.0	1	10	120	—	■	K series	
		D1FL20U	200	1.1	25 *2	20	150	0.98	1.1	10	35	○	○	—	
		D1FL40U	400	1.5	103 *1	30	150	1.2	1	10	25	○	○	—	
SC-110B CE	B5-1	D3CE20LUS	200	3	105 *1	60	-55 to 150	0.98	3	10	25	○	○	—	
		D3CE60K	600	3	78 *1	50	150	1.45	3	10	80	○	○	K series	
DO-214AA similar M2F	B6	M2FL20U	200	1.5	31 *2	50	150	0.92	1.5	10	35	—	○	—	
		M3FL20U	200	3	75 *1	75	150	0.95	3	10	35	○	○	—	
— 2F	B9-1	D2FL40	400	1.3	25 *2	40	150	1.3	1.3	10	50	—	—	—	
		D2FL20U	200	1.5	25 *2	50	150	0.98	1.5	10	35	○	○	—	
		D2FK60	600	1.5	101 *1	40	150	1.3	1.5	10	75	—	○	K series	
SC-63 E-pack	G1-5	D3FK60	600	2.1	93 *1	120	150	1.2	2.1	10	75	—	○	K series	
		DE3L20UA	200	3	137	60	150	0.98	3	10	35	—	■	—	
		DE5L60U	600	5	91	60	150	3.0	5	25	25	—	—	—	
DE5L60A	600	5	119	60	150	2.0	5	10	50	—	■	—			
TO-277A similar FY	G4	D5FY60K	600	5	130 *1	200	-55 to 150	1.25	5	10	95	—	■	K series	
SC-83 similar STO-220	H1-2	DF8L60US	600	8	66	60	150	3.6	8	50	25	—	—	US series	
		DF10L60	600	10	105	100	150	1.9	10	10	50	—	—	—	
		DF20L60	600	20	84	170	150	1.9	20	25	70	—	—	—	
		DF20L60U	600	20	93	160	150	3.0	20	25	35	—	—	—	
TO-252AA similar FR	G5	D10FR60LA	600	10	110	140	-55 to 150	2.1	10	10	28	○	○	A series	
		D15FR60LA	600	15	95	220	-55 to 150	2.1	15	10	30	○	○	A series	
SC-83 similar FD	H2-1	D8FD60LUS	600	8	120	60	175	3.6	8	50	25	—	○	US series	
		D20FD60LU	600	20	93	160	150	3.0	20	25	35	○	○	—	
		D30FD60K	600	30	102	300	150	1.7	30	10	95	—	■	K series	







■ : New product *1 : Tl *2 : Ta ■ : Please contact us.

Axial															
JEDEC Code JEITA Code House Name	Fig.	Type No.	Absolute Maximum Ratings					Electrical Characteristics					Based on AEC-Q101	Automotive	Series
			VRRM [V]	If (AV) [A]	Conditions Ta [°C]	IfSM [A]	Tj [°C]	Vf (max) [V]	Conditions If [A]	Ir (max) Vr=VRRM [μA]	trr (max) [ns]				
AX057	A1	D1NF60	600	0.8	25	50	150	1.3	0.8	10	400	—	—	—	
		D1NK60	600	0.8	26	35	150	1.3	0.8	10	75	—	—	K series	
		D1NL20U	200	1	25	25	150	0.98	1	10	35	—	—	—	
		D1NL40U	400	1	137 *1	50	150	1.25	1	10	25	—	—	—	
		D1NK100	1000	1	127 *1	30	150	2.1	1	10	75	—	—	K series	
AX078	A4-1	D2L20U	200	1.5	125 *1	40	150	0.98	1.5	10	35	—	—	—	
		D2L40U	400	2	108 *1	80	150	1.25	2	10	35	—	—	—	
AX10	A5-1	S2L20U	200	1.5	25	50	150	0.98	1.5	10	35	—	—	—	
		S2L60	600	1.5	125 *1	50	150	1.5	1.5	10	50	—	—	—	
		S2L40U	400	2	120 *1	100	150	1.25	2	10	35	—	—	—	
AX14	A7	S2K100	1000	2	91 *1	65	150	2.1	2	10	75	—	—	K series	
		S3L60	600	2.2	132 *1	60	150	1.5	2.2	10	50	—	—	—	
		S3L20U	200	3	128 *1	60	150	0.98	2.1	10	35	—	—	—	
		S3L40U	400	3	126 *1	150	150	1.25	3	10	35	—	—	—	
S3K60	600	3	123 *1	120	150	1.3	3	10	100	—	—	K series			

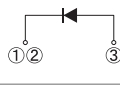
*1 : Tl

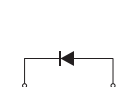

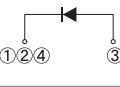

FAST RECOVERY DIODES

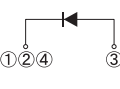
Single

Two Terminal Type								
Package	JEDEC Code JEITA Code House Name	Fig.	IF(AV) [A]	VRRM[V]			Remarks	
				200	400	600		
 28.5 × 10.0 × 4.5(mm)	- SC-91A FTO-220	J1	3			SF3L60U		
			5			SF5L60U		
			10			SF10L60U		
			20			SF20L60U		
 28.5 × 10.0 × 4.5(mm)	- SC-91 FTO-220AG	J3	3			SF3K60M		
			5		SF5L40UM	SF5K60M		
			8			SF8K60USM		SF8K60M
			10			SF10K60M		SF10L60MVM
						SF10L60MSM		SF10L60MSM
			20			SF20K60M		SF20L60MVM
 28.5 × 10.0 × 4.5(mm)	- SC-91 FTO-220G	J4	5		SG5L20USM			
			10		SG10L20USM			
 41.0 × 16.0 × 5.0(mm)	TO-247AD - MTO-3PT	K2	20			S20K60T		
			30			S30K60T		

Three Terminal Type							
Package	JEDEC Code JEITA Code House Name	Fig.	IF(AV) [A]	VRRM[V]			Remarks
				600	1000	1200	
 41.0 × 16.0 × 5.0(mm)	TO-247AD - MTO-3PV	K6	20		S20K100V		
			30	S30K60V	S30K100V		

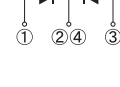
Center Tap, Common Cathode

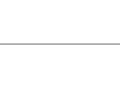
Surface Mount								
Package	JEDEC Code JEITA Code House Name	Fig.	IF(AV) [A]	VRRM[V]				Remarks
				200	300	400	600	
 9.5 × 6.6 × 2.65(mm)	- SC-63 E-pack	G1-1	5				DE5LC20U	
			10	DF10LC20U	DF10LC30			
 13.2 × 10.2 × 4.7(mm)	- SC-83 similar STO-220	H1-1	20	DF20LC20US	DF20LC30			
			20	D20FDC20L	D20FDC20LUS			
 13.2 × 10.2 × 4.6(mm)	- SC-83 similar FD	H2-2	20					

Single

Two Terminal Type															
Package		Type No.	Absolute Maximum Ratings					Electrical Characteristics					Based on AEC-Q101	Automotive	Series
JEDEC Code JEITA Code House Name	Fig.		VRRM [V]	IF (AV) [A]	Conditions Tc [°C]	IFSM [A]	Tj [°C]	Vf (max) [V]	Conditions IF [A]	Ir (max) Vr=VRRM [μA]	ttrr (max) [ns]				
- SC-91A FTO-220	J1	SF3L60U	600	3	115	40	150	3.00	3	25	20	-	-	-	
		SF5L60U	600	5	96	60	150	3.00	5	25	25	-	-	-	
		SF10L60U	600	10	85	120	150	3.00	10	25	25	-	■	-	
		SF20L60U	600	20	68	180	150	3.00	20	25	35	-	■	-	
- SC-91 FTO-220AG	J3	SF3K60M	600	3	132	90	150	1.45	3	10	80	-	-	K series	
		SF5L40UM	400	5	121	100	150	1.25	5	10	30	-	■	-	
		SF5K60M	600	5	119	120	150	1.50	5	10	85	-	■	K series	
		SF8K60USM	600	8	70	60	150	3.60	8	50	25	-	-	US series	
		SF8K60M	600	8	108	150	150	1.50	8	10	90	-	■	K series	
		SF10K60M	600	10	106	180	150	1.50	10	10	95	-	-	K series	
		SF10L60MVM	600	10	119	200	150	1.10	10	10	115	-	-	ML series	
		SF10L60MSM	600	10	110	160	150	1.37	10	10	60	-	-	ML series	
		SF20K60M	600	20	96	240	150	1.50	20	10	95	-	-	K series	
		SF20L60MVM	600	20	106	250	150	1.10	20	10	130	-	-	ML series	
SC-91 FTO-220G	J4	SG5L20USM	200	5	125	90	150	0.96	5	10	25	-	-	-	
TO-247AD	K2	S20K60T	600	20	121	300	150	1.50	20	10	95	-	-	K series	
MTO-3PT		S30K60T	600	30	123	450	150	1.50	30	10	100	-	-	K series	

■ : Please contact us.

Three Terminal Type															
Package		Type No.	Absolute Maximum Ratings					Electrical Characteristics					Based on AEC-Q101	Automotive	Series
JEDEC Code JEITA Code House Name	Fig.		VRRM [V]	IF (AV) [A]	Conditions Tc [°C]	IFSM [A]	Tj [°C]	Vf (max) [V]	Conditions IF [A]	Ir (max) Vr=VRRM [μA]	ttrr (max) [ns]				
TO-247AD - MTO-3PV	K6	S20K100V	1000	20	127	550	150	2.10	20	10	120	-	○	K series	
		S30K60V	600	30	108	450	150	1.50	30	10	100	-	○	K series	
		S30K100V	1000	30	116	600	150	2.10	30	10	120	-	○	K series	







Center Tap, Common Cathode

Surface Mount															
Package		Type No.	Absolute Maximum Ratings					Electrical Characteristics					Based on AEC-Q101	Automotive	Series
JEDEC Code JEITA Code House Name	Fig.		VRRM [V]	IF (AV) [A]	Conditions Tc [°C]	IFSM [A]	Tj [°C]	Vf (max) [V]	Conditions IF [A]	Ir (max) Vr=VRRM [μA]	ttrr (max) [ns]				
- SC-63 E-pack	G1-1	DE5LC20U	200	5	81	50	150	0.98	2.5	10	35	-	■	-	
- SC-83 similar STO-220	H1-1	DF10LC20U	200	10	127	80	150	0.98	5	10	35	-	-	-	
		DF10LC30	300	10	124	80	150	1.30	5	25	30	-	-	-	
		DF20LC20US	200	20	125	180	150	0.96	10	10	25	-	-	-	
- SC-83 similar FD	H2-2	DF20LC30	300	20	124	180	150	1.30	10	25	30	-	-	-	
		D20FDC20L	200	20	113	100	175	1.20	10	10	30	○	○	-	
		D20FDC20LUS	200	20	125	180	150	0.96	10	10	25	-	○	-	

■ : Please contact us.

FAST RECOVERY DIODES

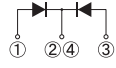
Center Tap, Common Cathode

Three Terminal Type								
Package	JEDEC Code JEITA Code House Name	Fig.	IF(AV) [A]	VRRM[V]				Remarks
				200	300	400	600	
 28.5 × 10.0 × 4.5(mm)	SC-91 FTO-220AG	J8-1	5			SF5LC40UM		
			10			SF10LC40UM	SF10KC60M	
			20		SF20LC30M	SF20KC60M		
 28.5 × 10.0 × 4.5(mm)	SC-91 FTO-220G	J9	5	SG5LC20USM				
			10	SG10LC20USM				
			20	SG20LC20USM				
 41.0 × 16.0 × 5.0(mm)	TO-247AD MTO-3PT	K5-2	20	S20LC20UST	S20LC30T	S20LC40UT	S20LC60UST	
 41.0 × 16.0 × 5.0(mm)	TO-247AD MTO-3PV	K7-1	20			S20LC40UV	S20LC60USV	

Center Tap, Common Cathode





Three Terminal Type		Type No.	Absolute Maximum Ratings					Electrical Characteristics					Based on AEC-Q101	Automotive	Series
JEDEC Code JEITA Code House Name	Fig.		VRRM [V]	IF (AV) [A]	Conditions Tc [°C]	IFSM [A]	Tj [°C]	Vf (max) [V]	Conditions If [A]	Ir (max) Vr=VRRM [μA]	ttr (max) [ns]				
SC-91 FTO-220AG	J8-1	SF5LC40UM	400	5	132	80	150	1.25	2.5	10	30	-	-	-	
		SF10LC40UM	400	10	120	100	150	1.25	5	10	30	-	-	-	
		SF10KC60M	600	10	109	120	150	1.50	5	10	85	-	■	K series	
		SF20LC30M	300	20	107	250	150	1.30	10	25	30	-	-	-	
SC-91 FTO-220G	J9	SF20KC60M	600	20	97	180	150	1.50	10	10	95	-	■	K series	
		SG5LC20USM	200	5	133	70	150	0.96	2.5	10	25	-	-	-	
		SG10LC20USM	200	10	122	90	150	0.96	5	10	25	-	-	-	
TO-247AD MTO-3PT	K5-2	SG20LC20USM	200	20	95	150	150	0.96	10	10	25	-	-	-	
		S20LC20UST	200	20	126	120	150	0.96	10	10	25	-	-	-	
		S20LC30T	300	20	124	220	150	1.30	10	25	30	-	-	-	
TO-247AD MTO-3PV	K7-1	S20LC40UT	400	20	123	130	150	1.25	10	10	30	-	-	-	
		S20LC60UST	600	20	63	60	150	3.60	10	50	25	-	-	-	
		S20LC40UV	400	20	123	200	150	1.25	10	10	30	-	○	-	
		S20LC60USV	600	20	65	60	150	3.60	10	50	25	-	○	-	

■ : Please contact us.

THYRISTORS

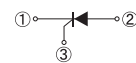

The Thyristor, in its normal state, will block an applied voltage in either direction, but when an appropriate current pulse is applied to the gate, current will flow through the anode to the cathode thus turning on power to the load circuit. The Thyristor has a planar passivation, and is available in both the general reverse-blocking type and the type without reverse voltage. The Thyristor without reverse voltage is suitable for a circuit limiting inrush current.

Thyristors

Package	 10.0 × 6.6 × 2.3(mm)	 28.5 × 10.0 × 4.5(mm)
JEDEC Code JEITA Code House Name	TO-252AA - FB	SC-91 FTO-220AG
Fig.	G2-2	J8-5
Internal Circuit		
$I_T(AV)$ [A]	3	5
V_{DRM} [V]	400	KC3FB40H
	600	KC5FB40H KC5FB60H KC5FB60HR KC5FB60HRT
	800	 KC5SF60HRT
		 KC8SF80

 : New product

Thyristors

Package		Type No.	Absolute Maximum Ratings					Electrical Characteristics					Based on AEC-Q101	Automotive	
JEDEC Code JEITA Code House Name	Fig.		V_{DRM} [V]	V_{RRM} [V]	$I_T(AV)$ [A]	Conditions T_c [°C]	I_{TSM} [A]	T_J [°C]	$V_{TM(max)}$ [V]	Conditions I_{TM} [A]	$V_{GT(max)}$ [V]	$I_{GT(max)}$ [μA]			$I_H(max)$ [mA]
TO-252AA - FB	G2-2	KC3FB40H	400	400	3	111	40	-40 to 125	1.4	4	0.8	100	5	-	-
		KC5FB40H	400	400	5	101	65	-40 to 125	1.6	10	0.8	200	typ.1	-	-
		KC5FB60H	600	600	5	98	90	-40 to 125	1.8	15	0.8	100	5	-	-
		KC5FB60HR	600	-	5	98	90	-40 to 125	1.8	15	0.8	100	5	-	-
SC-91 FTO-220AG	J8-5	 KC5SF60HRT	600	-	5	127	82	-40 to 150	1.8	15	0.8	100	5	-	-
		 KC8SF80	800	800	8	130	120	-40 to 150	1.5	20	1.0	15mA	100	-	-

 : New product



SIDACs

SIDAC series are semiconductor devices energized by the addition of a specific voltage. They are commonly used for switching devices or pulse generating devices.

Bi-directional (K1V series)

- Features
 1. Symmetrical characteristics.
 2. Operating directly from the AC mains, and can be used in all kinds of pulse generating circuits.
 3. The glass passivation ensures high reliability.



- Applications
 1. Pulse generation : gas igniters,HID(high intensity discharge)lamp drive circuit,etc.
 2. AC switching : drive circuit for switching power supplies,voltage detecting circuits,etc.
 3. Over voltage protection : AC line surge protection,capacitor rupture prevention,etc.

Package			
JEDEC Code	DO-214AC	—	—
JEITA Code	—	—	—
House Name	1F	AX06	AX10
Fig.	B4-3	A2-1	A5-3
Internal Circuit	①—N—②		
V _{DRM} [V]	5	K1VZL09	
	15	K1VZL20	
	90	K1V(A)10 K1V(A)11 K1V(A)12	K1V10 K1V11 K1V12
	115	K1V(A)16	K1V14
	180		K1V22 K1V24 K1V26
	270		K1V22(W) K1V24(W) K1V26(W) K1V36(W) K1V38(W)

Uni-directional (G1V series)

- Features
 1. Uni-directional characteristics.
 2. Smaller package than bi-directional SIDAC.
 3. Switching operation from DC power for pulse generation.
 4. The glass passivation ensures high reliability.

- Applications
 1. Pulse generation : gas igniters,negative ion generators, HID(high intensity discharge) lamp drive circuit,etc.
 2. Over voltage protection : DC line surge protection.

Package			
JEDEC Code	DO-214AC	—	—
JEITA Code	—	—	—
House Name	1F	AX06	AX078
Fig.	B3-3	A2-3	A4-3
Internal Circuit	①— —②		
V _{DRM(A)} [V]	70	G1VL8C	G1V(A)8C
	90	G1VL10C	G1V(A)10C
	100		G1V(A)12C
	110		G1V(A)13C
	115		G1V(A)15C
	120	G1VL15C	G1V(A)14C
	170	G1VL20C	G1V(A)20C
	210	G1VL22C G1VL24C	

Bi-directional (K1V series)

Surface Mount		Type No.	Absolute Maximum Ratings					Electrical Characteristics						Automotive	
JEDEC Code	Fig.		V _{DRM}	I _T	Conditions	T _{stg}	T _J	V _{BO}	I _{DRM}	Conditions	I _{BO}	I _H	V _T		Conditions
JEITA Code	House Name	[V]	[A]	T _L [°C]	[°C]	[°C]	[V]	[μA]	V _D [V]	[mA]	[mA]	[V]	I _T [A]		
DO-214AC	B4-3	K1VZL09	5	0.5	110	-40 to 125	125	8 to 12	5	5	20	20	1.2	0.5	—
1F		K1VZL20	15	0.5	110	-40 to 125	125	18 to 22	5	15	20	20	1.2	0.5	—

Axial		Type No.	Absolute Maximum Ratings							Electrical Characteristics						Automotive
JEDEC Code	Fig.		V _{DRM}	I _T	Conditions	I _{TSM}	I _{TRM}	Conditions	dit/dt	T _J	V _{BO}	I _H	V _T	Conditions	R _S	
JEITA Code	House Name	[V]	[A]	T _L [°C]	[A]	[A]	f [Hz]	[A/μs]	[°C]	[V]	[mA]	[V]	I _T [A]	[kΩ]		
—	AX06	K1V(A)10	90	1	109	16	60	60	50	125	95 to 113	50	1.6	1	0.1	—
		K1V(A)11	90	1	109	16	60	60	50	125	104 to 118	50	1.6	1	0.1	—
		K1V(A)12	90	1	109	16	60	60	50	125	110 to 125	50	1.6	1	0.1	—
—	A5-3	K1V10	90	1	112	20	80	60	80	125	95 to 113	50	1.5	1	0.1	—
		K1V11	90	1	112	20	80	60	80	125	104 to 118	50	1.5	1	0.1	—
		K1V12	90	1	112	20	80	60	80	125	110 to 125	50	1.5	1	0.1	—
		K1V14	115	1	109	20	80	60	80	125	125 to 150	30	1.5	1	0.1	—
		K1V22	180	1	108	20	50	60	80	125	200 to 230	20	1.5	1	0.1	—
		K1V24	180	1	108	20	50	60	80	125	220 to 250	20	1.5	1	0.1	—
	AX10	K1V26	180	1	108	20	50	60	80	125	240 to 270	20	1.5	1	0.1	—
		K1V22(W)	180	1	91	16	50	60	80	125	200 to 230	50	3	1	0.1	—
		K1V24(W)	180	1	91	16	50	60	80	125	220 to 250	50	3	1	0.1	—
		K1V26(W)	180	1	91	16	50	60	80	125	240 to 265	50	3	1	0.1	—
A6	K1V36(W)	270	1	92	13	40	60	50	125	340 to 380	50	3	1	0.1	—	
	K1V38(W)	270	1	92	13	40	60	80	125	360 to 400	50	3	1	0.1	—	

Uni-directional (G1V series)

Surface Mount		Type No.	Absolute Maximum Ratings					Electrical Characteristics					Automotive		
JEDEC Code	Fig.		V _{DRM(A)}	I _T	Conditions	I _{TRM}	Conditions	dit/dt	T _J	V _{BO}	I _H	V _T		Conditions	
JEITA Code	House Name	[V]	[A]	T _L [°C]	[A]	f [Hz]	[A/μs]	[°C]	[V]	[mA]	[V]	I _T [A]			
DO-214AC	1F	B3-3	G1VL8C	70	1	98	80	60	150	125	75 to 90	100	1.5	1	—
			G1VL10C	90	1	98	150	60	150	125	95 to 110	100	1.5	1	—
			G1VL15C	120	1	98	120	60	150	125	142 to 157	60	1.5	1	—
			G1VL20C	170	1	98	120	60	150	125	190 to 210	60	1.5	1	—
			G1VL22C	190	1	98	280	5	150	125	210 to 230	60	1.5	1	—
			G1VL24C	190	1	98	280	5	150	150	230 to 250	60	1.5	1	—

Axial		Type No.	Absolute Maximum Ratings					Electrical Characteristics					Automotive		
JEDEC Code	Fig.		V _{DRM(A)}	I _T	Conditions	I _{TRM}	Conditions	dit/dt	T _J	V _{BO}	I _H	V _T		Conditions	
JEITA Code	House Name	[V]	[A]	T _L [°C]	[A]	f [Hz]	[A/μs]	[°C]	[V]	[mA]	[V]	I _T [A]			
—	AX06	A2-3	G1V(A)8C	70	1	98	80	60	80	125	75 to 90	100	1.5	1	—
			G1V(A)10C	90	1	98	80	60	80	125	95 to 110	60	1.5	1	—
			G1V(A)12C	100	1	98	80	60	80	125	110 to 130	60	1.5	1	—
			G1V(A)13C	110	1	98	80	60	80	125	120 to 138	60	1.5	1	—
			G1V(A)14C	120	1	98	80	60	80	125	130 to 150	60	1.5	1	—
			G1V(A)15C	115	1	98	80	60	80	125	142 to 157	60	1.5	1	—
—	AX078	A4-3	G1V(B)20C	170	1	102	120	60	220	150	190 to 210	60	1.5	1	—
			G1V(B)22C	190	1	98	160	60	220	125	210 to 230	60	1.5	1	—
			G1V(B)24C	210	1	102	120	60	220	150	230 to 250	60	1.5	1	—



TRIACs

TRIACs are bidirectional Thyristors.

Our TRIACs are easy to use for motor and heater controls due to balanced gate sensitivity and (di/dt)_c.

Our lineup ranges from V_{DRM}=600 to 800V, I_{T(RMS)}=3 to 20A.

TRIACs (Triode for Alternating Current)

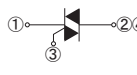
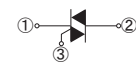
Package	 10.0 × 6.6 × 2.3(mm)	 28.5 × 10.0 × 4.5(mm)
JEDEC Code JEITA Code House Name	TO-252AA - FB	SC-91 FTO-220AG
Fig.	G2-3	J8-4
Internal Circuit		
V _{DRM} [V]	600	
I _{T(RMS)} [A]	3 5 8 12 16 20	Ⓝ KD3SF60E Ⓝ KD3SF60 Ⓝ KD5SF60 Ⓝ KD8SF60 Ⓝ KD12SF60 Ⓝ KD16SF60 Ⓝ KD20SF60

Ⓝ : New product

TRIACs (Triode for Alternating Current)

Surface Mount		Type No.	Absolute Maximum Ratings			Electrical Characteristics						Based on AEC-Q101	Automotive
JEDEC Code JEITA Code House Name	Fig.		I _T (RMS) [A]	V _{DRM} [V]	T _J [°C]	V _{TM} (max) [V]	Conditions I _{TM} [A]	V _{GT} (max) (I, II, III)* [V]	I _{GT} (max) (I, II, III)* [mA]	(dv/dt) _c (T _J =150°C, V _D =2/3V _{DRM}) [V/μs]	Conditions (di/dt) _c [A/ms]		
TO-252AA - FB	G2-3	Ⓝ KD3FB60	3	600	-40 to 150	1.7	4.5	1.5	15	1	-1.5	-	-

Ⓝ : New product * : Operation mode IV is not guaranteed.

Two Terminal Type		Type No.	Absolute Maximum Ratings			Electrical Characteristics						Based on AEC-Q101	Automotive
JEDEC Code JEITA Code House Name	Fig.		I _T (RMS) [A]	V _{DRM} [V]	T _J [°C]	V _{TM} (max) [V]	Conditions I _{TM} [A]	V _{GT} (max) (I, II, III)* [V]	I _{GT} (max) (I, II, III)* [mA]	(dv/dt) _c (T _J =150°C, V _D =2/3V _{DRM}) [V/μs]	Conditions (di/dt) _c [A/ms]		
SC-91 FTO-220AG	J8-4	Ⓝ KD3SF60E	3	600	-40 to 150	1.5	4.5	1.5	10	-	-	-	-
		Ⓝ KD3SF60	3	600	-40 to 150	1.5	4.5	1.5	20	1	-1.5	-	-
		Ⓝ KD5SF60	5	600	-40 to 150	1.8	7	1.5	20	1	-2.5	-	-
		Ⓝ KD8SF60	8	600	-40 to 150	1.6	12	1.5	30	1	-4.0	-	-
		Ⓝ KD12SF60	12	600	-40 to 150	1.6	20	1.5	30	1	-6.0	-	-
		Ⓝ KD16SF60	16	600	-40 to 150	1.5	25	1.5	30	1	-8.0	-	-
Ⓝ KD20SF60	20	600	-40 to 150	1.4	30	1.5	30	1	-10.0	-	-		

Ⓝ : New product * : Operation mode IV is not guaranteed.

Operation Mode	Terminal Characteristics		
	① T1	②④ T2	③ G
I	-	+	+
II	-	+	-
III	+	-	-
IV	+	-	+

TRIACs



SURGE ABSORBERS

Surge Absorbers are semiconductor devices of the Thyristor type that turns on when triggered by their rated voltage. They are commonly used for lightning surge protection in communications equipment.

Thyristor Surge Suppressors

- Features
 1. Bi-directional or uni-directional characteristics.
 2. High speed response.
 3. Large surge current capacity.
 4. Repetitive use against surges is possible.

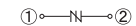
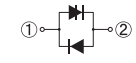

- Applications
 1. Lightning surge adsorption for communications circuits.
 2. Lightning surge adsorption for transmitters and switchboards.
 3. Surge protection for ISDN terminals.

Series	KL Series	KU Series	KP Series	
Package	 5.0 × 2.5 × 2.0(mm)	 5.1 × 3.75 × 2.0(mm)	 7.6 × 4.0 × 2.8(mm)	
JEDEC Code JEITA Code House Name	DO-214AC - 1F	DO-214AA similar - M2F	- - 2F	
Fig.	B4-3	B7 B8	B9-4	
Internal Circuit				
Off-state Voltage V ₀ [V]	5	KL3Z07		
	15	KL3Z18		
	58	KL3L07		
	63		KU10L08	
	70		KU4F8	
	90		KU10NU11	
	92			KP20NU11 KP40NU11
	100		KU4F12	
	115		KU10NU13	
	120	KL3N14	KU10N14 KU15N14	
	175	KL3R20		
	180			KP40RU22
	190		KU10R23NS KU10R27NS	
	220		KU10R29NS	
250		KU5S31NS KU10S31NS KU10S35NS		
275				

Varistor

- Features
 1. Bi-directional surge absorption is possible.
 2. Low junction capacitance.

- Applications
 1. Telephone set surge absorption.
 2. Digital communications circuit surge absorption.
 3. ISDN terminal surge absorption.

Package	 5.0 × 2.5 × 2.0(mm)
JEDEC Code JEITA Code House Name	DO-214AC - 1F
Fig.	B4-1
Internal Circuit	
V _{F2} [V]	2.75 ± 0.25
	VR-61F1

Thyristor Surge Suppressors

Package		Type No.	Absolute Maximum Ratings				Electrical Characteristics			UL	Automotive
JEDEC Code JEITA Code House Name	Fig.		I _{TSM} [A]	Conditions [μs]	V _{DRM} [V]	T _j [°C]	V _{BO} (min) [V]	I _H (min) [mA]	C _t (max) [pF]		
DO-214AC - 1F	B4-3	KL3Z07	30	10/1000	5	125	5.5 *1	50	-	-	-
		KL3Z18	30	10/1000	15	125	15.5 *1	50	-	-	-
		KL3L07	30	10/1000	58	125	65	100	90	-	-
		KL3N14	30	10/1000	120	125	130	100	50	-	-
		KL3R20	30	10/1000	175	125	180	100	30	-	-
DO-214AA similar - M2F	B7	KU10L08	100	10/1000	63	125	70	100	180	UL*	-
		KU4F8	40	10/1000	70	125	75	100	100	-	-
	B8	KU10NU11	100	10/1000	60	125	100	150	-	-	-
		KU4F12	40	10/1000	100	125	110	100	100	-	-
	B7	KU10NU13	100	10/1000	60	125	120	100	-	-	-
		KU10N14	100	10/1000	120	125	125	100	140	UL*	-
		KU15N14	150	10/1000	120	125	125	100	110	UL*	-
		KU10R23NS	100	10/1000	190	125	290 *2	100	90	-	-
		KU10R27NS	100	10/1000	220	125	320 *2	100	70	UL*	-
		KU10R29NS	100	10/1000	250	125	400 *2	100	70	UL*	-
-	B9-4	KU5S31NS	50	10/1000	275	125	420 *2	150	70	-	-
		KU10S31NS	100	10/1000	275	125	420 *2	100	90	UL*	-
		KU10S35NS	100	10/1000	275	125	450 *2	100	90	-	-
		KP20NU11	325	10/700	60	125	100	150	295 *3	-	-
-	2F	KP40NU11	500	10/700	60	125	100	150	485 *3	-	-
		KP40RU22	500	10/700	60	125	195	100	285 *3	-	-

*1 : V_{BR} *2 : V_{CL(max)} *3 : typ. UL* : UL497B recognized (UL File No.E183905)

Varistor

Package		Type No.	Absolute Maximum Ratings			Electrical Characteristics		Automotive
JEDEC Code JEITA Code House Name	Fig.		I _{F(RMS)} [mA]	I _{FSM} [A]	T _j [°C]	V _{F1} [V]	Conditions I _F [mA]	
DO-214AC - 1F	B4-1	VR-61F1	370	7.5	150	2.3 ± 0.25	1	-

TVS (Transient Surge Suppressor)

TVSs are low voltage PN junction type devices.

These devices utilize technologically stable glass passivation (an in-house design) with a structural advantage that brings high resistance against heat and humidity.

They are available with a voltage range between 12 to 320V and peak pulse power from 200 to 8000W.

TVS (Transient Voltage Suppressor)

- Features
 - 1.High speed response.
 - 2.Absorption energy tolerance capacity.
 - 3.Narrow clamping voltage width.

- Applications
 - 1.IC protection for telephones.
 - 2.IC protection against abnormal voltage.
 - 3.Protection for load dump noise.

Peak pulse power	200W		600W	2000W		6000 ~ 8000W (Load Dump Surge Protecting)		
Package								
JEDEC Code JEITA Code House Name	DO-219AB similar SC-109 G1F	DO-214AC — 1F	DO-214AC — 1F	DO-214AC — 1F	DO-214AC — 2F	DO-214AC — MCP	DO-214AC similar STO-220	TO-263AB — FZ
Fig.	B1-2	B3-2	B4-2	B5-2	B9-5	B10	E1	H1-6
Internal Circuit								
VBR (typ) [V]	12.5	ST02-12G1	ST04-12F1					
	14	ST02-14G1	ST04-14F1				ST80-14MF	
	16	ST02-16G1	ST04-16F1					
	18	ST02-18G1	ST04-18F1	DL04-18F1	ST06-18CE			
	20	ST02-20G1	ST04-20F1					
	24	ST02-24G1	ST04-24F1					
	27	ST02-27G1	ST04-27F1		ST06-27CE	ST20-27F2	ST70-27MF	ST70-27F
	30	ST02-30G1	ST04-30F1		ST06-30CE	ST20-30F2	ST70-30MF	
	33	ST02-33G1	ST04-33F1	DL04-33F1	ST06-33CE	ST20-33F2		
	36	ST02-36G1	ST04-36F1	DL04-36F1	ST06-36CE	ST20-36F2		
	39	ST02-39G1	ST04-39F1		ST06-39CE			
	40							ST60-40MF
	43	ST02-43G1	ST03-43F1					
	47	ST02-47G1	ST03-47F1			ST20-47F2		
	48							ST60-48MF
	58	ST02-58G1	ST03-58F1					
	68		ST03-68F1					
	75		ST02-75F1					
	82		ST02-82F1					
	100		ST02-100F1					
120		ST02-120F1						
145		ST02-140F1						
170		ST02-170F1						
200		ST02-200F1						
240		ST03-240F1						
280		ST02-280F1						
320		ST02-320F1						

■ : New product

TVS (Transient Voltage Suppressor)

JEDEC Code JEITA Code House Name	Fig.	Type No.	Absolute Maximum Ratings			Electrical Characteristics					Based on AEC-Q101	Automotive		
			Prsm [W]	Tj [°C]	Vr (DC) [V]	Vbr (min) [V]	Vbr (max) [V]	Conditions Ir [mA]	Ir (max) [μA]	Conditions Vr [V]				
DO-219AB similar SC-109 G1F	B1-2	ST02-12G1	200	-55 to 175	9	11.5	13.5	5	5	9	○	○		
		ST02-14G1	200	-55 to 175	12.8	13.5	15	5	5	12.8	○	○		
		ST02-16G1	200	-55 to 175	13.6	14.4	17.6	5	5	13.6	○	○		
		ST02-18G1	200	-55 to 175	13	16.8	19.1	5	5	13	○	○		
		ST02-20G1	200	-55 to 175	16	18.8	22	5	5	16	○	○		
		ST02-24G1	200	-55 to 175	20	22	25.6	5	5	20	○	○		
		ST02-27G1	200	-55 to 175	23	25.1	28.9	2	5	23	○	○		
		ST02-30G1	200	-55 to 175	24	28	32	2	5	24	○	○		
		ST02-33G1	200	-55 to 175	25	31	35	2	5	25	○	○		
		ST02-36G1	200	-55 to 175	27	34	38	2	5	27	○	○		
		ST02-39G1	200	-55 to 175	30	37	41	2	5	30	○	○		
		ST02-43G1	200	-55 to 175	33	40	45	2	5	33	○	○		
		ST02-47G1	195	-55 to 175	37	42	52	2	5	37	■	○		
		ST02-58G1	175	-55 to 175	45	52	64	2	5	45	○	○		
DO-214AC — 1F	B3-2	ST04-12F1	400	-55 to 175	9	11.5	13.5	1	5	9	○	○		
		ST04-14F1	400	-55 to 175	12.8	13.5	15	1	5	12.8	○	○		
		ST04-16F1	400	-55 to 175	13.6	14.4	17.6	1	5	13.6	○	○		
		ST04-18F1	400	-55 to 175	15.3	16.8	19.1	1	5	15.3	○	○		
		ST04-20F1	400	-55 to 175	16	18.8	21.2	1	5	16	○	○		
		ST04-24F1	400	-55 to 175	20	22.8	25.6	1	5	20	○	○		
		ST04-27F1	400	-55 to 175	23	24.3	29.7	1	5	23	○	○		
		ST04-30F1	400	-55 to 175	24	28	32	1	5	24	○	○		
		ST04-33F1	400	-55 to 175	25	31	35	1	5	25	○	○		
		ST04-36F1	400	-55 to 175	27	34	38	1	5	27	○	○		
		ST04-39F1	400	-55 to 175	30	37	41	1	5	30	○	○		
		ST03-43F1	300	-55 to 150	33	40	45	1	5	33	○	○		
		ST03-47F1	300	-55 to 150	37	42	52	1	5	37	○	○		
		ST03-58F1	300	-55 to 150	45	52	64	1	5	45	○	○		
		ST03-68F1	300	-55 to 150	58	64.4	71.2	1	5	58	○	○		
		ST02-75F1	200	-55 to 150	61	70	79	1	5	61	○	○		
		ST02-82F1	200	-55 to 150	67	74	90	1	5	67	○	○		
		ST02-100F1	200	-55 to 150	80	90	110	1	5	80	○	○		
		ST02-120F1	200	-55 to 150	100	110	130	1	5	33	■	○		
		ST02-140F1	200	-55 to 150	120	130	160	1	5	120	■	○		
		ST02-170F1	200	-55 to 150	145	155	185	1	5	145	■	○		
		ST02-200F1	200	-55 to 150	170	185	215	1	5	170	■	○		
		ST03-240F1	310	-55 to 175	200	220	250	1	5	200	■	○		
		ST02-280F1	200	-55 to 175	230	250	300	1	5	230	○	○		
		ST02-320F1	150	-55 to 175	260	300	350	1	5	260	○	○		
		DO-214AC — 1F	B4-2	DL04-18F1	400	-55 to 150	13	16.8	19.1	5	5	13	○	○
				DL04-33F1	400	-55 to 175	25	31	35	1	5	25	○	○
				DL04-36F1	400	-55 to 175	27	34	38	1	5	27	○	○
— SC-110B CE	B5-2	ST06-18CE	600	-55 to 175	13	16.8	19.1	1	5	13	○	○		
		ST06-27CE	600	-55 to 175	23	25	29	1	5	23	○	○		
		ST06-30CE	600	-55 to 175	24	28	32	1	5	24	○	○		
		ST06-33CE	600	-55 to 175	25	31	35	1	5	25	○	○		
		ST06-36CE	600	-55 to 175	27	34	38	1	5	27	○	○		
		ST06-39CE	600	-55 to 175	30	37	41	1	5	30	○	○		
— — 2F	B10	ST20-47F2	1700	-55 to 175	37	42	52	1	5	37	○	○		
		ST20-27F2	2000	-55 to 175	23	24.3	29.7	1	5	23	○	○		
		ST20-30F2	2000	-55 to 175	24	28	32	1	5	24	—	○		
		ST20-33F2	2000	-55 to 175	25	31	35	1	5	25	○	○		
— — MCP	E1	ST80-14MF	8000	-40 to 150	12	13	15	1	10	12	—	○		
		ST70-27MF	7000	-40 to 150	23	24.3	29.7	1	5	23	—	○		
		ST70-30MF	7000	-40 to 150	26	27.5	33	1	5	26	—	○		
		ST60-40MF	6000	-40 to 150	32	36.5	44	1	5	32	—	○		
		ST60-48MF	6000	-40 to 150	40	43.2	54	1	5	40	—	○		
— SC-83 similar STO-220 TO-263AB — FZ	H1-6	ST70-27F	7000	-40 to 150	23	24.3	29.7	1	5	23	—	○		
		ST70-27FZ	7000	-55 to 175	23	25	29	1	5	23	○	○		





■ : New product ■ : Please contact us.

TVS (Transient Surge Suppressor)

Power Clampers

- Features
- 1.High speed response.
 - 2.Absorption energy tolerance capacity.
 - 3.Narrow clamping voltage width.
 - 4.Reverse blocking type.

- Application 1.Snubber circuit in the primary side of switch-mode power supplies.

Package			
	7.6 × 4.0 × 2.8(mm)	5.0 × φ 4.0(mm)	7.0 × φ 4.4(mm)
JEDEC Code	—	—	—
JEITA Code	—	—	—
House Name	2F	AX078	AX10
Fig.	B9-3	A4-2	A5-2
Internal Circuit			
V _{BR} (typ) [V]	82	ST02D-82	ST03D-82
	145	ST02D-140F2	ST03D-140
	170	ST02D-170F2	ST03D-170
	200	ST02D-200	ST03D-200
	240		ST03DH-240
	280		★ ST02DH-280
	320		★ ST02DH-320

★ : Under development

Power Clampers

Surface Mount		Type No.	Absolute Maximum Ratings				Electrical Characteristics						Automotive
Package			PrSM [W]	T _J [°C]	V _{RM} (max) [V]		ZD			Di			
JEDEC Code	JEITA Code				ZD	Di	V _{BR} (min) [V]	V _{BR} (max) [V]	Conditions I _R [mA]	I _R (max) [μA]	I _R (max) [μA]	Conditions V _R [V]	
—	2F	B9-3	200	-40 to 150	120	600	130	160	1	5	5	600	—
—	2F	B9-3	200	-40 to 150	145	600	155	185	1	5	5	600	—

Axial		Type No.	Absolute Maximum Ratings				Electrical Characteristics						Automotive
Package			PrSM [W]	T _J [°C]	V _{RM} (max) [V]		ZD			Di			
JEDEC Code	JEITA Code				ZD	Di	V _{BR} (min) [V]	V _{BR} (max) [V]	Conditions I _R [mA]	I _R (max) [μA]	I _R (max) [μA]	Conditions V _R [V]	
—	AX078	A4-2	200	-40 to 150	67	600	74	90	1	5	5	600	—
—	AX078	A4-2	200	-40 to 150	120	600	130	160	1	5	5	600	—
—	AX078	A4-2	200	-40 to 150	145	600	155	185	1	5	5	600	—
—	AX078	A4-2	200	-40 to 150	170	600	185	215	1	5	5	600	—
—	AX10	A5-2	300	-40 to 150	67	600	74	90	1	5	5	600	—
—	AX10	A5-2	300	-40 to 150	120	600	130	160	1	5	5	600	—
—	AX10	A5-2	300	-40 to 150	145	600	155	185	1	5	5	600	—
—	AX10	A5-2	300	-40 to 150	170	600	185	215	1	5	5	600	—
—	AX10	A5-2	300	-40 to 150	200	1000	220	250	1	5	10	1000	—
—	AX10	A5-2	300	-40 to 150	230	1000	250	300	1	5	10	1000	—
—	AX10	A5-2	300	-40 to 150	260	1000	300	350	1	5	10	1000	—

★ : Under development

POWER MOSFETs

The EETMOS series offer world-class performance applying a trench-gate structure with an optimized layout hence lowered Qg.

Series	Feature
EETMOS2	Evenly balanced Ron and Qg
EETMOS3/3Z	Low Ron, Low Qg
EETMOS4	Ultra Low Ron, Low Qg

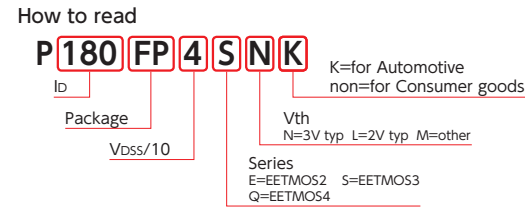

EETMOS Series (Nch Single)

Surface Mount		JEDEC Code JEITA Code House Name	Fig.	Id [A]	V _{DSS} [V]					Remarks					
Package	Id [A]				40	60	75	100	120						
6.0 × 4.9 × 1.0(mm)	LA	G6	15							P15LA12SL					
			18							P18LA12SL					
			19							P19LA10SL					
			23							P23LA10SL					
			25							P25LA12SL					
			30							P30LA10SL					
			56	P56LA4SN											
			6.05 × 5.30 × 1.05(mm)	MO-235B similar LF	G7	25								P25LF12SLK P25LF12SL P25LF12SNK P25LF12SN	
						32								P32LF10SLK P32LF10SL P32LF10SNK P32LF10SN	
						38	P38LF6QLK P38LF6QNK								
40										P40LF12SLK P40LF12SL P40LF12SNK P40LF12SN					
46						P46LF7R5SLK P46LF7R5SL P46LF7R5SNK P46LF7R5SN									
50								P50LF10SLK P50LF10SL P50LF10SNK P50LF10SN							
64		P64LF6QLK P64LF6QL P64LF6QNK P64LF6QN													
70	P70LF4QLK P70LF4QNK														
72						P72LF7R5SLK P72LF7R5SL P72LF7R5SNK P72LF7R5SN									
98		P98LF6QLK P98LF6QL P98LF6QNK P98LF6QN													
105	P105LF4QLK P105LF4QL P105LF4QNK P105LF4QN P140LF4QLK P140LF4QL P140LF4QNK P140LF4QN														
10.0 × 6.6 × 2.3(mm)	TO-252AA FB	G2-1				8							P8B10SB		
						16		P16B6SB							
						20							P20B12SN P20B12SL		
						24	P24B4SB								
			25		P25B6EB										
			26							P26B10SL P26B10SN P30B10EL					
			30												
			32							P32B12SN					
			40		P40B6SL										
			54	P54B4SN											
60	P60B4EL P60B4SN	P60B6EL P60B6EN P60B6SN													





N : New product

EETMOS Series (Nch Single)

Surface Mount		JEDEC Code JEITA Code House Name	Fig.	Type No.	Absolute Maximum Ratings					Electrical Characteristics					Based on AEC-Q101	Automotive	Series	
Package	Id [A]				V _{DSS} [V]	I _D [A]	I _{DP} [A]	P _T [W]	T _{ch} [°C]	R _{DS(ON)} (typ) [mΩ]	R _{DS(ON)} (max) [mΩ]	C _{iss} (typ) [pF]	Q _g (typ) [nC]	V _{th} (typ) [V]				R _{th(j-c)} (max) [°C/W]
LA	G6			P56LA4SN	40	56	168	99	-55 to 150	4.5	5.7	1680	38	3.0	1.26	-	-	EETMOS3
				P19LA10SL	100	19	57	83	-55 to 150	28	35	1730	38	2.0	1.5	-	-	EETMOS3
				P23LA10SL	100	23	69	99	-55 to 150	23	29	2080	46	2.0	1.26	-	-	EETMOS3
				P30LA10SL	100	30	90	142	-55 to 150	16.8	21.0	2890	61	2.0	0.88	-	-	EETMOS3
				P15LA12SL	120	15	45	83	-55 to 150	40	50	1735	38.5	2.0	1.5	-	-	EETMOS3
				P18LA12SL	120	18	54	99	-55 to 150	35	44	2090	47	2.0	1.26	-	-	EETMOS3
				P25LA12SL	120	25	75	142	-55 to 150	24	30	2900	61	2.0	0.88	-	-	EETMOS3
				P70LF4QLK	40	70	210	123	-55 to 175	3.6	4.5	2360	49	2.0	1.21	○	○	EETMOS4
				P70LF4QNK	40	70	210	123	-55 to 175	3.9	4.9	1890	38	3.0	1.21	○	○	EETMOS4
				P105LF4QLK	40	105	315	168	-55 to 175	2.1	2.7	4090	76	2.0	0.89	○	○	EETMOS4
MO-235B similar LF	G7			P105LF4QL	40	105	315	168	-55 to 175	2.1	2.7	4090	76	2.0	0.89	-	-	EETMOS4
				P105LF4QNK	40	105	315	168	-55 to 175	2.2	2.8	3400	62	3.0	0.89	○	○	EETMOS4
				P140LF4QLK	40	140	560	217	-55 to 175	1.17	1.42	6630	122	2.0	0.69	○	○	EETMOS4
				P140LF4QL	40	140	560	217	-55 to 175	1.17	1.42	6630	122	2.0	0.69	-	-	EETMOS4
				P140LF4QNK	40	140	560	217	-55 to 175	1.22	1.48	5530	96	3.0	0.69	○	○	EETMOS4
				P140LF4QN	40	140	560	217	-55 to 175	1.22	1.48	5530	96	3.0	0.69	-	-	EETMOS4
				P38LF6QLK	60	38	114	123	-55 to 175	7.9	9.9	2340	49	2.0	1.21	○	○	EETMOS4
				P38LF6QNK	60	38	114	123	-55 to 175	8.3	10.4	1875	35	3.0	1.21	○	○	EETMOS4
				P64LF6QLK	60	64	192	168	-55 to 175	4.5	5.7	4260	77	2.0	0.89	○	○	EETMOS4
				P64LF6QL	60	64	192	168	-55 to 175	4.5	5.7	4260	77	2.0	0.89	-	-	EETMOS4
				P64LF6QNK	60	64	192	168	-55 to 175	4.5	5.7	3540	61	3.0	0.89	○	○	EETMOS4
				P64LF6QN	60	64	192	168	-55 to 175	4.5	5.7	3540	61	3.0	0.89	-	-	EETMOS4
				P98LF6QLK	60	98	392	217	-55 to 175	2.5	3.2	6770	126	2.0	0.69	○	○	EETMOS4
				P98LF6QL	60	98	392	217	-55 to 175	2.5	3.2	6770	126	2.0	0.69	-	-	EETMOS4
				P98LF6QNK	60	98	392	217	-55 to 175	2.6	3.3	5650	96	3.0	0.69	○	○	EETMOS4
				P98LF6QN	60	98	392	217	-55 to 175	2.6	3.3	5650	96	3.0	0.69	-	-	EETMOS4
				P46LF7R5SLK	75	46	138	168	175	8.2	10.3	2890	61	2.0	0.89	○	○	EETMOS3
				P46LF7R5SL	75	46	138	168	-55 to 175	8.2	10.3	2890	61	2.0	0.89	-	-	EETMOS3
				P46LF7R5SNK	75	46	138	168	175	8	10	2380	48	3.0	0.89	○	○	EETMOS3
				P46LF7R5SN	75	46	138	168	-55 to 175	8	10	2380	48	3.0	0.89	-	-	EETMOS3
				P72LF7R5SLK	75	72	288	217	175	4.6	5.8	4870	100	2.0	0.69	○	○	EETMOS3
				P72LF7R5SL	75	72	288	217	-55 to 175	4.6	5.8	4870	100	2.0	0.69	-	-	EETMOS3
				P72LF7R5SNK	75	72	288	217	175	4.5	5.7	4080	78	3.0	0.69	○	○	EETMOS3
				P72LF7R5SN	75	72	288	217	-55 to 175	4.5	5.7	4080	78	3.0	0.69	-	-	EETMOS3
				P32LF10SLK	100	32	96	168	175	15.7	19.7	2890	61	2.0	0.89	○	○	EETMOS3
				P32LF10SL	100	32	96	168	-55 to 175	15.7	19.7	2890	61	2.0	0.89	-	-	EETMOS3
				P32LF10SNK	100	32	96	168	175	14.4	18.0	2430	48	3.0	0.89	○	○	EETMOS3
				P32LF10SN	100	32	96	168	-55 to 175	14.4	18.0	2430	48	3.0	0.89	-	-	EETMOS3
				P50LF10SLK	100	50	200	217	175	9.0	11.3	4900	102	2.0	0.69	○	○	EETMOS3
				P50LF10SL	100	50	200	217	-55 to 175	9.0	11.3	4900	102	2.0	0.69	-	-	EETMOS3
P50LF10SNK	100	50	200	217	175	8.3	10.4	4130	80	3.0	0.69	○	○	EETMOS3				
P50LF10SN	100	50	200	217	-55 to 175	8.3	10.4	4130	80	3.0	0.69	-	-	EETMOS3				
P25LF12SLK	120	25	75	168	175	23	29	2930	61	2.0	0.89	○	○	EETMOS3				
P25LF12SL	120	25	75	168	-55 to 175	23	29	2930	61	2.0	0.89	-	-	EETMOS3				
P25LF12SNK	120	25	75	168	175	21	27	2430	48	3.0	0.89	○	○	EETMOS3				
P25LF12SN	120	25	75	168	-55 to 175	21	27	2430	48	3.0	0.89	-	-	EETMOS3				
P40LF12SLK	120	40	160	217	175	13.0	16.3	5000	102	2.0	0.69	○	○	EETMOS3				
P40LF12SL	120	40	160	217	-55 to 175	13.0	16.3	5000	102	2.0	0.69	-	-	EETMOS3				
P40LF12SNK	120	40	160	217	175	12.3	15.4	4075	80	3.0	0.69	○	○	EETMOS3				
P40LF12SN	120	40	160	217	-55 to 175	12.3	15.4	4075	80	3.0	0.69	-	-	EETMOS3				
TO-252AA FB	G2-1			P24B4SB	40	24	72	20	-55 to 150	14.8	18.5	645	16.5	2.0	6.28	-	-	EETMOS3
				P54B4SN	40	54	162	44	-55 to 150	5.0	6.3	1650	36	3.0	2.84	-	-	EETMOS3
				P60B4EL	40	60	240	62.5	-55 to 150	3.3	4.2	2900	57	2.0	2	-	-	EETMOS2
				P60B4SN	40	60	180	62.5	-55 to 150	3.2	4.0	2830	59	3.0	2	-	-	EETMOS3
				P16B6SB	60	16	48	20	-55 to 150	29	37	655	17	2.0	6.28	-	-	EETMOS3
				P25B6EB	60	25	70	35	-55 to 150	23	29	785	14.5	2.0	3.55	-	-	EETMOS2
				P40B6SL	60	40	120	44	-55 to 150	9.5	12.0	2050	43	2.0	2.84	-	-	EETMOS3
				P60B6EL	60	60	240	62.5	-55 to 150	6.1	7.7	2920	55	2.0	2	-	-	EETMOS2
				P60B6EN	60	60	240	62.5	-55 to 150	6.4	8.0	2550	44	3.0	2	-	-	EETMOS2
				P60B6SN	60	60	180	62.5	-55 to 150	5.3	6.7	2780	55	3.0	2	-	-	EETMOS3
				P8B10SB	100	8	24	20	-55 to 150	75	94	665	16.5	2.0	6.28	-	-	EETMOS3



POWER MOSFETs

EETMOS Series (Nch Single)

Surface Mount														
Package	JEDEC Code JEITA Code House Name	Fig.	Id [A]	V _{DS} [V]							Remarks			
				40	50	55	60	75	100	120	150			
	TO-252AB similar SC-63 FE	G3-2	8						P8FE10SBK					
			12											
			14						P12FE7R5SBK					
			20								P20FE12SLK			
			22	P22FE4SBK										
			26											
	TO-263AB - FG	H4	30	P30FE4SLK					P30FE6SLK	P30FE7R5SLK				
			32									P32FG15SL		
			80						P80FG6EAL	P80FG7R5EN				
			85						P85FG6EAL					
	TO-263AB-1 - FH	H3	80		P80FH5ENK									
			100	P100FH4ENK										
	SC-83 similar FP	H5	70								P70FP12SNK			
			88							P88FP10SNK		P88FP10SN		
			100									P100FP12SNK		
			126									P126FP10SNK		
			153						P153FP6SNK				P153FP6SN	
			168								P168FP7R5SNK		P168FP7R5SN	
			175	P175FP4SNK										
			180	P180FP4SNK							P180FP6SNK		P180FP4SN	
			180	P180FP4SNK							P180FP6SN			
				TO-263SC - FZ-7p	H7	211	P211FZ4QMKA							
240	P240FZ4QLA													

 : New product

THD (Through Hole Device)

THD (Through Hole Device)														
Package	JEDEC Code JEITA Code House Name	Fig.	Id [A]	V _{DS} [V]							Remarks			
				40	50	60	70	75	100	120				
	SC-91 FTO-220AG	J8-2	22							P22F10SN				
			32								P32F12SN			
			34						P34F6EL					
			40								P40F10SN	P40F12SN		
			42						P42F6EN					
			50									P50F10SN		
			55						P55F6EN					
			66										P66F7R5SNK	
	TO-220AB SC-46 FA	J5	70		P70F5EN						P66F7R5SNK			
			82								P70F7R5EN			
			86						P86F6SN				P82F7R5SN	
			100										P100FA7R5EN	

 : New product

EETMOS Series (Nch Single)

Surface Mount																
Package		Fig.	Type No.	Absolute Maximum Ratings					Electrical Characteristics					Based on AEC-Q101	Automotive	Series
JEDEC Code JEITA Code House Name				V _{DS} [V]	I _D [A]	I _{DP} [A]	P _T [W]	T _{ch} [°C]	R _{DS(ON)} (typ) [mΩ] V _{GS} =10V	R _{DS(ON)} (max) [mΩ] V _{GS} =10V	C _{ISS} (typ) [pF]	Q _G (typ) [nC]	V _{th} (typ) [V]			
TO-252AB similar SC-63 FE	G3-2	P22FE4SBK	40	22	66	24	-55 to 175	15.2	19.0	645	16.5	2.0	6.2	○	○	EETMOS3
		P30FE4SLK	40	30	90	44	-55 to 175	6.3	8.0	2020	44	2.0	3.4	○	○	EETMOS3
		P14FE6SBK	60	14	42	24	-55 to 175	31	39	655	16.3	2.0	6.2	○	○	EETMOS3
		P30FE6SLK	60	30	90	44	-55 to 175	10.9	13.8	2050	43	2.0	3.4	○	○	EETMOS3
		P12FE7R5SBK	75	12	36	24	-55 to 175	40	50	660	16.6	2.0	6.2	○	○	EETMOS3
		P30FE7R5SLK	75	30	90	44	-55 to 175	14.1	17.8	2020	45	2.0	3.4	○	○	EETMOS3
		P8FE10SBK	100	8	24	24	-55 to 175	79	99	665	16.5	2.0	6.2	○	○	EETMOS3
		P26FE10SLK	100	26	78	44	-55 to 175	24	30	1975	43	2.0	3.4	○	○	EETMOS3
		P20FE12SLK	120	20	60	44	-55 to 175	35	44	2110	46	2.0	3.4	○	○	EETMOS3
		TO-263AB - FG	H4	P90FG5R5SL	55	90	360	128	150	3.0	3.8	5130	106	2.0	0.97	-
P94FG5R5SL	55			94	376	156	150	2.5	3.2	7170	140	2.0	0.8	-	-	EETMOS3
P80FG6EAL	60			80	320	128	150	3.6	4.9	4700	90	2.0	0.97	-	-	EETMOS2
P85FG6EAL	60			85	340	156	150	3.2	4.3	5700	105	2.0	0.8	-	-	EETMOS2
P80FG7R5EN	75			80	320	128	150	5.1	6.4	4100	67	3.0	0.97	-	-	EETMOS2
P32FG15SL	150			32	96	100	150	3.2	4.0	3530	72	2.0	1.25	-	-	EETMOS3
TO-263AB-1 - FH	H3	P100FH4ENK	40	100	400	175	150	1.6	2.0	5500	100	3.0	0.71	-	○	EETMOS2
		P80FH5ENK	50	80	320	128	150	3.0	3.8	4000	70	3.0	0.97	-	○	EETMOS2
SC-83 similar FP	H5	P175FP4SNK	40	175	700	178	175	1.3	1.6	5900	116	3.0	0.84	○	○	EETMOS3
		P175FP4SN	40	175	700	178	175	1.3	1.6	5900	116	3.0	0.84	-	-	EETMOS3
		P180FP4SNK	40	180	720	238	175	0.95	1.15	9220	160	3.0	0.63	■	○	EETMOS3
		P180FP4SN	40	180	720	238	175	0.95	1.15	9220	160	3.0	0.63	-	-	EETMOS3
		P153FP6SNK	60	153	612	178	175	2.4	3.0	5850	105	3.0	0.84	■	○	EETMOS3
		P153FP6SN	60	153	612	178	175	2.4	3.0	5850	105	3.0	0.84	-	-	EETMOS3
		P180FP6SNK	60	180	720	238	175	1.6	2.0	9380	158	3.0	0.63	■	○	EETMOS3
		P180FP6SN	60	180	720	238	175	1.6	2.0	9380	158	3.0	0.63	-	-	EETMOS3
		P168FP7R5SNK	75	168	672	238	-55 to 175	2.2	2.8	9600	155	3.0	0.63	■	○	EETMOS3
		P168FP7R5SN	75	168	672	238	175	2.2	2.8	9600	155	3.0	0.63	-	-	EETMOS3
		P88FP10SNK	100	88	352	178	-55 to 175	6.1	7.6	6100	108	3.0	0.84	■	○	EETMOS3
		P88FP10SN	100	88	352	178	175	6.1	7.6	6100	108	3.0	0.84	-	-	EETMOS3
		P126FP10SNK	100	126	504	238	175	3.8	4.8	9500	160	3.0	0.63	■	○	EETMOS3
		P126FP10SN	100	126	504	238	175	3.8	4.8	9500	160	3.0	0.63	-	-	EETMOS3
		P70FP12SNK	120	70	280	178	-55 to 175	8.9	11.1	6100	109	3.0	0.84	■	○	EETMOS3
		P70FP12SN	120	70	280	178	175	8.9	11.1	6100	109	3.0	0.84	-	-	EETMOS3
P100FP12SNK	120	100	400	238	175	5.6	7.0	9600	164	3.0	0.63	■	○	EETMOS3		
P100FP12SN	120	100	400	238	175	5.6	7.0	9600	164	3.0	0.63	-	-	EETMOS3		
TO-263SC - FZ-7p	H7	P211FZ4QMKA	40	211	752	178	175	1.10	1.38	8550	145	4.0	0.84	-	-	EETMOS4
		P240FZ4QLA	40	240	720	178	-55 to 175	1.03	1.29	9675	171	2.0	0.84	-	-	EETMOS4
		P240FZ4QNKA	40	240	720	178	-55 to 175	1.07	1.34	7915	133	3.0	0.84	○	○	EETMOS4

 : New product  : Please contact us.

THD (Through Hole Device)

THD (Through Hole Device)																
Package		Fig.	Type No.	Absolute Maximum Ratings					Electrical Characteristics					Based on AEC-Q101	Automotive	Series
JEDEC Code JEITA Code House Name				V _{DS} [V]	I _D [A]	I _{DP} [A]	P _T [W]	T _{ch} [°C]	R _{DS(ON)} (typ) [mΩ] V _{GS} =10V	R _{DS(ON)} (max) [mΩ] V _{GS} =10V	C _{ISS} (typ) [pF]	Q _G (typ) [nC]	V _{th} (typ) [V]			
SC-91 FTO-220AG	J8-2	P70F5EN	50	70	280	53	150	2.7	3.2	5500	100	3.0	2.35	-	-	EETMOS2
		P34F6EL	60	34	136	35	-55 to 150	9.0	11.0	1960	41	2.0	3.55	-	-	EETMOS2
		P42F6EN	60	42	168	40	150	6.7	8.4	2540	47	3.0	3.12	-	-	EETMOS2
		P55F6EN	60	55	220	44	150	4.4	5.5	4100	73	3.0	2.84	-	-	EETMOS2
		P86F6SN	60	86	344	58	150	2.4	3.0	9380	181	3.0	2.15	-	-	EETMOS3
		P66F7R5SNK	75	66	264	51	-55 to 150	4.0	5.0	6070	115	3.0	2.45	-	○	EETMOS3
		P66F7R5SN	75	66	264	51	150	4.0	5.0	6070	115	3.0	2.45	-	-	EETMOS3
		P70F7R5EN	75	70	280	53	150	3.8	4.8	5720	105	3.0	2.35	-	-	EETMOS2
		P82F7R5SN	75	82	328	58	-55 to 150	3.0	3.8	9600	168	3.0	2.15	-	-	EETMOS3
		P22F10SN	100	22	66	35	150	2.2	2.8	1700	34	3.0	3.55	-	-	EETMOS3
		P40F10SN	100	40	160	44	150	8.5	10.7	4500	92	3.0	2.84	-	-	EETMOS3
		P50F10SN	100	50	200	51	150	6.9	8.7	5880	114	3.0	2.45	-	-	EETMOS3
		P32F12SN	120	32	128	44	150	12.4	15.5	4540						



POWER MOSFETs

The Hi-PotMOS series are MOSFETs with a high breakdown strength, and they are 100% screened using di/dt & avalanche testing.

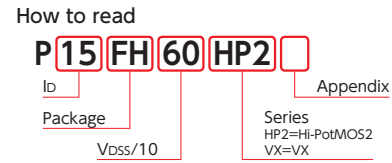
Series	Feature
HP2 (Hi-PotMOS2)	High breakdown resistance, Avalanche rated, di/dt inspection(all parts)
VX	Automotive qualified, Avalanche rated, di/dt inspection(all parts), High Breakdown resistance





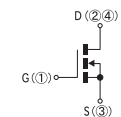

HP2 • VX Series (Nch Single)

Surface Mount										
Package	JEDEC Code JEITA Code House Name	Fig.	Id [A]	V _{DSS} [V]					Remarks	
				250/280/300	400	500/525	600	900		
	TO-252AA - FB	G2-1	0.5							
			1			P1B52HP2		P0R5B60HP2		
			1.5			P1R5B40HP2				
			2					P2B60HP2F		
			2.5			P2R5B52HP2F				
			3			P3B28HP2				
			4				P4B40HP2		P4B60HP2F	
			5					P5B52HP2		
			6			P6B28HP2	P6B40HP2	P6B52HP2		
			8			P8B28HP2				
9			P9B30HP2F	P9B40HP2						
10			P10B28HP2							
	TO-252AB similar SC-63 FE	G3-2	1						P1FE90VX3	
			2						P2FE60VX5K	
	TO-263AB-1 - FH	H3	3						★ P3FH90VX3	
			5						★ P5FH90VX3	
			7						P7FH60HP2	
			15					P15FH60HP2		
			20					P20FH50HP2		
			36					P36FH28HP2		



■ : New product ★ : Under development

THD (Through Hole Device)

Package	JEDEC Code JEITA Code House Name	Fig.	Id [A]	V _{DSS} [V]					Remarks	
				280	400	500	600	900		
	- SC-91 FTO-220AG	J8-2	3						P3F60HP2	
			4						★ P4F90VX3	
			5			P5F50HP2		P5F60HP2		
			6			P5F50HP2F				
			6			P6F50HP2				
			7							★ P7F90VX3
			8			P8F28HP2		P8F50HP2		
			10				P10F50HP2	P10F60HP2		
			12					P12F60HP2		
			13			P13F28HP2		P13F50HP2		
			15				P15F50HP2	P15F60HP2	P15F60HP2F	
			17			P17F28HP2				
			20					P20F50HP2		
			21			P21F28HP2				
26			P26F28HP2							
36			P36F28HP2							
	- SC-91 FTO-220A	J7-2	23						P23F40HP2FM	
	TO-247AD - MTO-3P	K4-2	85						P85W28HP2F	
					TO-247AD - MTO-3PV	K7-4	30			

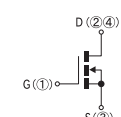
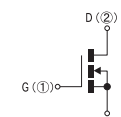

★ : Under development

HP2 • VX Series (Nch Single)

Surface Mount																
JEDEC Code JEITA Code House Name	Fig.	Type No.	Absolute Maximum Ratings				Electrical Characteristics						Body Diode trr (typ) [ns]	Based on AEC-Q101	Automotive	Series
			V _{DSS} [V]	I _D [A]	P _T [W]	T _{ch} [°C]	R _{DS(ON)} (typ) [Ω]	R _{DS(ON)} (max) [Ω]	C _{iss} [pF]	Q _g [nC]	V _{th} [V]	R _{th(j-c)} [°C/W]				
TO-252AA - FB	G2-1	P3B28HP2	280	3	35	150	1.7	2.0	120	3.6	3.75	3.55	-	-	-	HP2
		P6B28HP2	280	6	35	150	0.66	0.85	240	5.7	3.75	3.55	-	-	-	HP2
		P8B28HP2	280	8	54	150	0.38	0.50	400	9.8	3.75	2.31	-	-	-	HP2
		P8B30HP2	300	8	54	150	0.42	0.50	400	9.8	3.75	2.31	-	-	-	HP2
		■ P9B30HP2F	300	9	54	-55 to 150	0.44	0.55	402	14.0	4.5 *1	2.31	72	-	-	HP2
		P10B28HP2	280	10	70	150	0.30	0.40	500	11.4	3.75	1.78	-	-	-	HP2
		P1R5B40HP2	400	1.5	35	150	4.2	5.0	120	3.9	3.75	3.55	-	-	-	HP2
		P4B40HP2	400	4	35	150	1.54	1.90	245	6.5	3.75	3.55	-	-	-	HP2
		P6B40HP2	400	6	54	150	0.84	1.05	400	10	3.75	2.31	-	-	-	HP2
		P9B40HP2	400	9	40	150	0.65	0.80	575	14.5	3.75	3.12	-	-	-	HP2
		P1B52HP2	525	1	35	150	6.0	7.2	125	4.3	3.75	3.55	-	-	-	HP2
		P2R5B52HP2F	525	2.5	35	150	2.5	3.2	240	6.7	3.25	3.55	52	-	-	HP2
		P5B52HP2	525	5	54	150	1.4	1.7	400	10.5	3.75	2.31	-	-	-	HP2
		P6B52HP2	525	6	70	150	1.10	1.35	520	15	3.75	1.78	-	-	-	HP2
		P0R5B60HP2	600	0.5	35	150	8.3	10.0	120	4.3	3.75	3.55	-	-	-	HP2
		P2B60HP2F	600	2	35	150	3.4	4.2	240	6.8	3.25	3.55	52	-	-	HP2
		P4B60HP2F	600	4	70	150	1.6	1.9	520	13	3.25	1.78	75	-	-	HP2
		TO-252AB similar SC-63 FE	G3-2	P1FE90VX3	900	1	36	-55 to 150	9.5	14.0	193	10.8	3.5	3.4	-	○
P6FE25VX5K	250			6	27	150	0.58	0.70	250	10	3.75	4.62	-	-	○	VX
P2FE60VX5K	600			2	27	150	3.4	4.2	247	12	3.75	4.62	-	-	○	VX
TO-263AB-1 - FH	H3	P36FH28HP2	280	36	175	150	0.08	0.12	1730	35	3.75	0.71	-	-	-	HP2
		P20FH50HP2	500	20	175	150	0.29	0.36	1735	40	3.75	0.71	-	-	-	HP2
		★ P3FH90VX3	900	3	128	-55 to 150	2.8	3.4	600	22	4.0 *1	0.97	-	■	○	VX
		★ P5FH90VX3	900	5	175	-55 to 150	1.2	1.5	1380	41	4.0 *1	0.71	-	■	○	VX
		P7FH60HP2	600	7	128	150	0.88	1.05	810	19	3.75	0.97	-	-	-	HP2
		P15FH60HP2	600	15	175	150	0.41	0.49	1750	37	3.75	0.71	-	-	-	HP2

■ : New product ★ : Under development *1 : max. ■ : Please contact us.

THD (Through Hole Device)

THD (Through Hole Device)																		
JEDEC Code JEITA Code House Name	Fig.	Type No.	Absolute Maximum Ratings				Electrical Characteristics						Body Diode trr (typ) [ns]	Based on AEC-Q101	Automotive	Series		
			V _{DSS} [V]	I _D [A]	P _T [W]	T _{ch} [°C]	R _{DS(ON)} (typ) [Ω]	R _{DS(ON)} (max) [Ω]	C _{iss} [pF]	Q _g [nC]	V _{th} [V]	R _{th(j-c)} [°C/W]						
- SC-91 FTO-220AG	J8-2	P8F28HP2	280	8	52.5	-55 to 150	0.38	0.5	400	9.8	3.75	2.38	-	-	-	HP2		
		P13F28HP2	280	13	65	150	0.23	0.3	630	15	3.75	1.92	-	-	-	HP2		
		P17F28HP2	280	17	79	150	0.17	0.23	830	19.5	3.75	1.58	-	-	-	HP2		
		P21F28HP2	280	21	85	150	0.13	0.18	1000	20.5	3.75	1.47	-	-	-	HP2		
		P26F28HP2	280	26	90	150	0.11	0.15	1200	24.5	3.75	1.39	-	-	-	HP2		
		P36F28HP2	280	36	95	150	0.08	0.12	1730	35	3.75	1.32	-	-	-	HP2		
		P5F50HP2	500	5	52.5	150	1.3	1.6	400	10.5	3.75	2.38	-	-	-	HP2		
		P5F50HP2F	500	5	52.5	150	1.38	1.65	405	10.5	3.25	2.38	70	-	-	HP2		
		P6F50HP2	500	6	62.5	150	1.00	1.25	500	12.5	3.75	2.00	-	-	-	HP2		
		P8F50HP2	500	8	65	150	0.8	1.0	610	15	3.75	1.92	-	-	-	HP2		
		P10F50HP2	500	10	79	-55 to 150	0.60	0.75	820	20	3.75	1.58	-	-	-	HP2		
		P13F50HP2	500	13	85	150	0.48	0.60	1050	25	3.75	1.47	-	-	-	HP2		
		P15F50HP2	500	15	90	150	0.4	0.5	1340	27	3.75	1.39	-	-	-	HP2		
		P20F50HP2	500	20	95	150	0.29	0.36	1735	40	3.75	1.32	-	-	-	HP2		
		P3F60HP2	600	3	52.5	150	1.92	2.30	400	10	3.75	2.38	-	-	-	HP2		
		P4F60HP2	600	4	62.5	150	1.5	1.8	505	12.5	3.75	2.00	-	-	-	HP2		
		P5F60HP2	600	5	65	150	1.17	1.40	615	15	3.75	1.92	-	-	-	HP2		
		P7F60HP2	600	7	79	150	0.88	1.05	810	19	3.75	1.58	-	-	-	HP2		
		P10F60HP2	600	10	85	150	0.67	0.80	1040	23	3.75	1.47	-	-	-	HP2		
		P12F60HP2	600	12	90	150	0.56	0.67	1230	26.5	3.75	1.39	-	-	-	HP2		
		P15F60HP2	600	15	95	-55 to 150	0.41	0.49	1750	37	3.75	1.32	-	-	-	HP2		
		P15F60HP2F	600	15	95	-55 to 150	0.44	0.53	1720	34	3.25	1.32	88	-	-	HP2		
		★ P4F90VX3	900	4	79	150	2.8	3.6	595	21	4.0 *1	1.58	-	-	-	VX		
		★ P7F90VX3	900	7	95	150	1.2	1.7	1375	42	4.0 *1	1.32	-	-	-	VX		
		- SC-91 FTO-220A	J7-2	P23F40HP2FM	400	23	104	150	0.17	0.24	1620	40	3.25	1.2	68	-	-	HP2
		- TO-247AD - MTO-3P	K4-2	P85W28HP2F	280	85	310	-55 to 150	0.035	0.045	4440	90	3.45	0.4	76	-	-	HP2
		- TO-247AD - MTO-3PV	K7-4	P30W60HP2V	600	30	310	-55 to 150	0.185	0.23	3935	70						

POWER MODULES

Power Modules include combinations of various power semiconductors. They are easy to design, reduce the number of components needed in the device, are suitable for device downsizing, and mitigate heat-dissipation concerns. At Shindengen, a multitude of packages allow us to meet customer needs of MOSFET, diodes, and other products. Semi customizable support and customizable package design support are available.

Transfer Type Package Sample

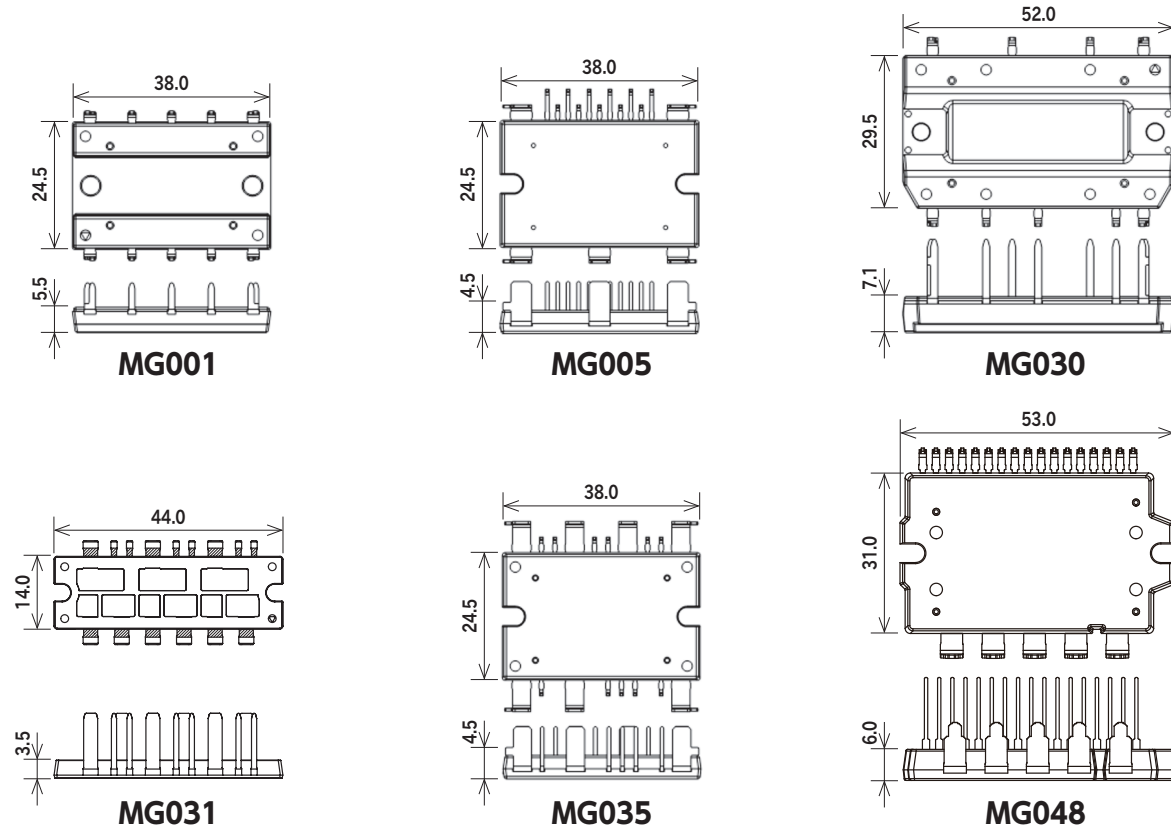

Potting Type Package Sample

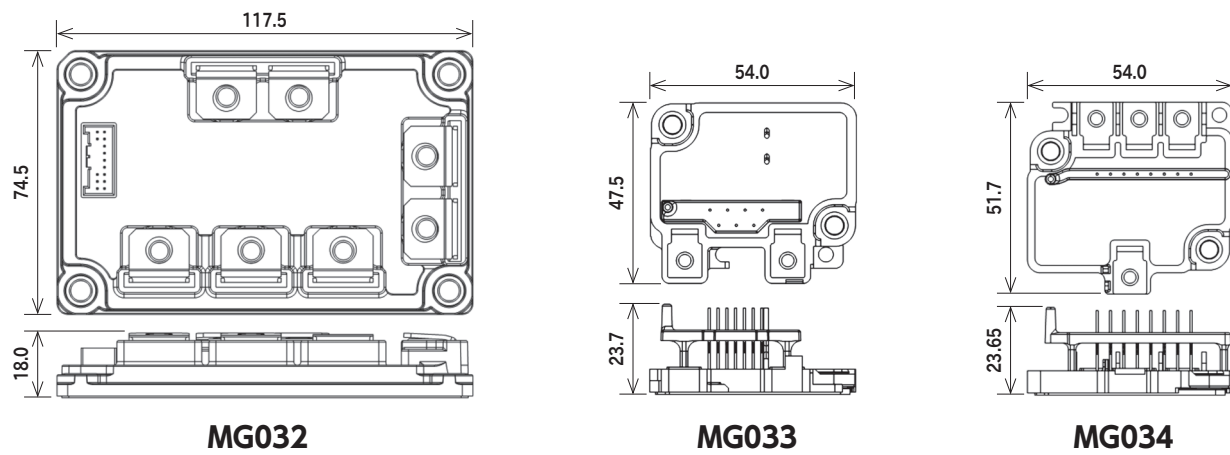

CB Module Series

Type No.	Package		Converter Diode				Brake IGBT				Brake FRD				UL	Automotive				
			Absolute Maximum Ratings		Electric Characteristics		Absolute Maximum Ratings		Electric Characteristics		Absolute Maximum Ratings		Electric Characteristics							
	JEDEC Code	JEITA Code	Fig.	V _{RRM} [V]	I _F (AV) [A]	Conditions T _C [°C]	V _F (max) [V]	Conditions I _F [A]	V _{CES} [V]	I _c [A]	V _{CE} (sat) (typ) [V]	Conditions I _c [A]	V _{RRM} [V]	I _F (AV) [A]			Conditions T _C [°C]	V _F (max) [V]	Conditions I _F [A]	t _{rr} (max) [ns]
MG020200	-	-	F4	600	20.0	137	1.05	7.0	600	28.0	2.10	15.0	600	3.0	137	1.65	3.0	50	UL	-
MG020201	-	MG001		600	30.0	136	1.05	10.0	600	30.0	2.00	30.0	600	3.0	137	1.65	3.0	50	UL	-

UL : UL recognize (UL File No.E142422)

Equivalent Circuit Schematic

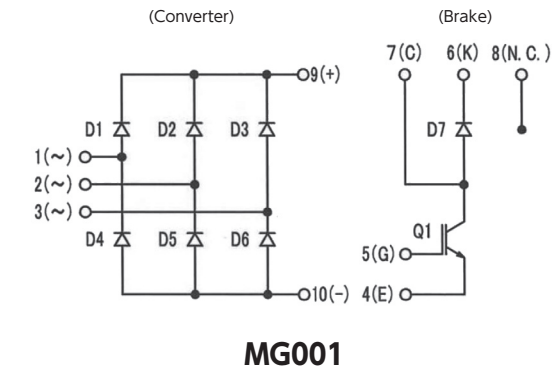

INV Module Series

Type No.	Package		Absolute Maximum Ratings					Electrical Characteristics					UL	Automotive			
			V _{DSS} [V]	I _D [A]	I _{DP} [A]	P _T [W]	T _{ch} [°C]	R _{DS(ON)} (typ) [mΩ]	R _{DS(ON)} (max) [mΩ]	C _{iss} (typ) [pF]	Q _g (typ) [nC]	V _{th} (typ) [V]			R _{th(j-c)} (max) [°C/W]		
MG032A4207R5A	-	-	F6	75	420	840	500	150	-	0.98	80120	505	3.0	0.25	-	○	
MG032B420010A	-	MG032		100	420	840	500	150	0.99	1.37	91800	500	3.0	0.25	-	○	
MG031B090004A	-	-	F5	40	90	360	125	175	2.34	3.20	4180	76	2.0	1.2	-	○	
MG031E120004A	-	-		40	120	480	125	175	2.44	3.10	3540	68	3.0	1.2	-	■	
MG031G148004A	-	-		40	148	592	154	175	1.75	2.20	5330	96	3.0	0.97	-	○	
MG031L080006A	-	-		60	80	320	125	175	4.47	5.60	3570	65	3.0	1.2	-	■	
MG031N110006A	-	MG031		60	110	440	154	175	3.0	3.8	5630	94	3.0	0.97	-	■	
MG031MC148004A	-	-		40	148	592	154	175	1.75	2.20	5330	96	3.0	0.97	-	■	
MG031MD110006A	-	-		60	110	440	154	175	3.1	3.9	5630	94	3.0	0.97	-	■	
MG048A150004A	-	-		F8	40	150	600	147	150	2.1	2.7	5900	111	3.0	0.85	-	■
MG048B100006A	-	MG048			60	100	400	147	150	2.82	3.92	8186	136	3.0	0.85	-	■

■ : New product ★ : Under development ■ : Please contact us.

Equivalent Circuit Schematic

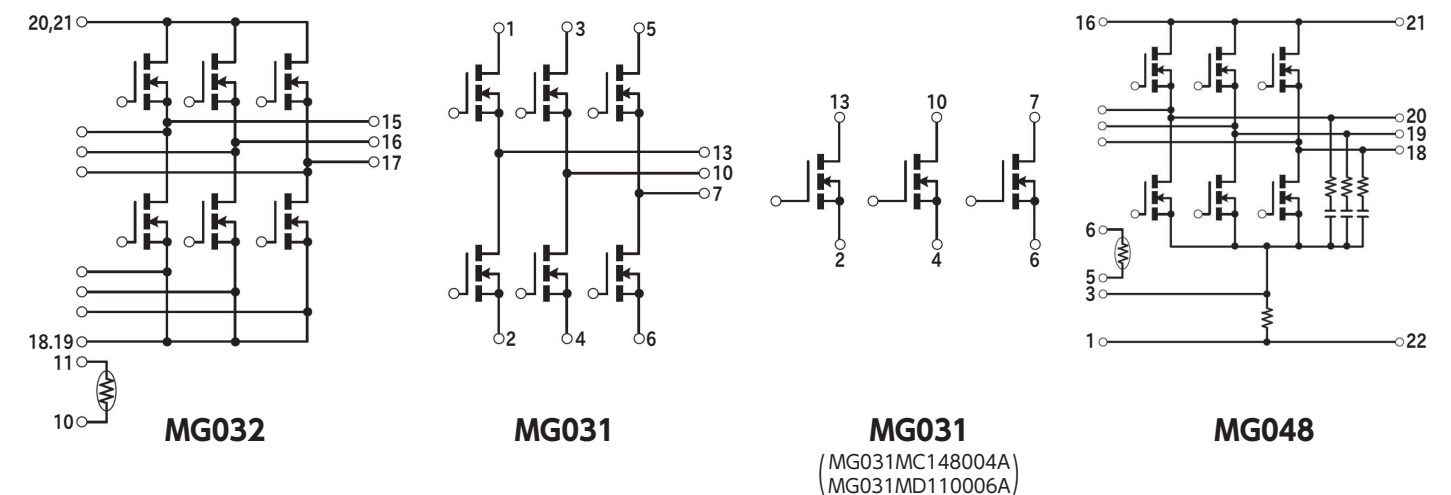

POWER ICs

Line up

IC for LED Lighting

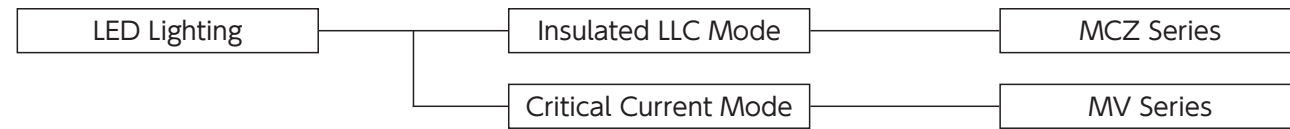

IC for Power Supply

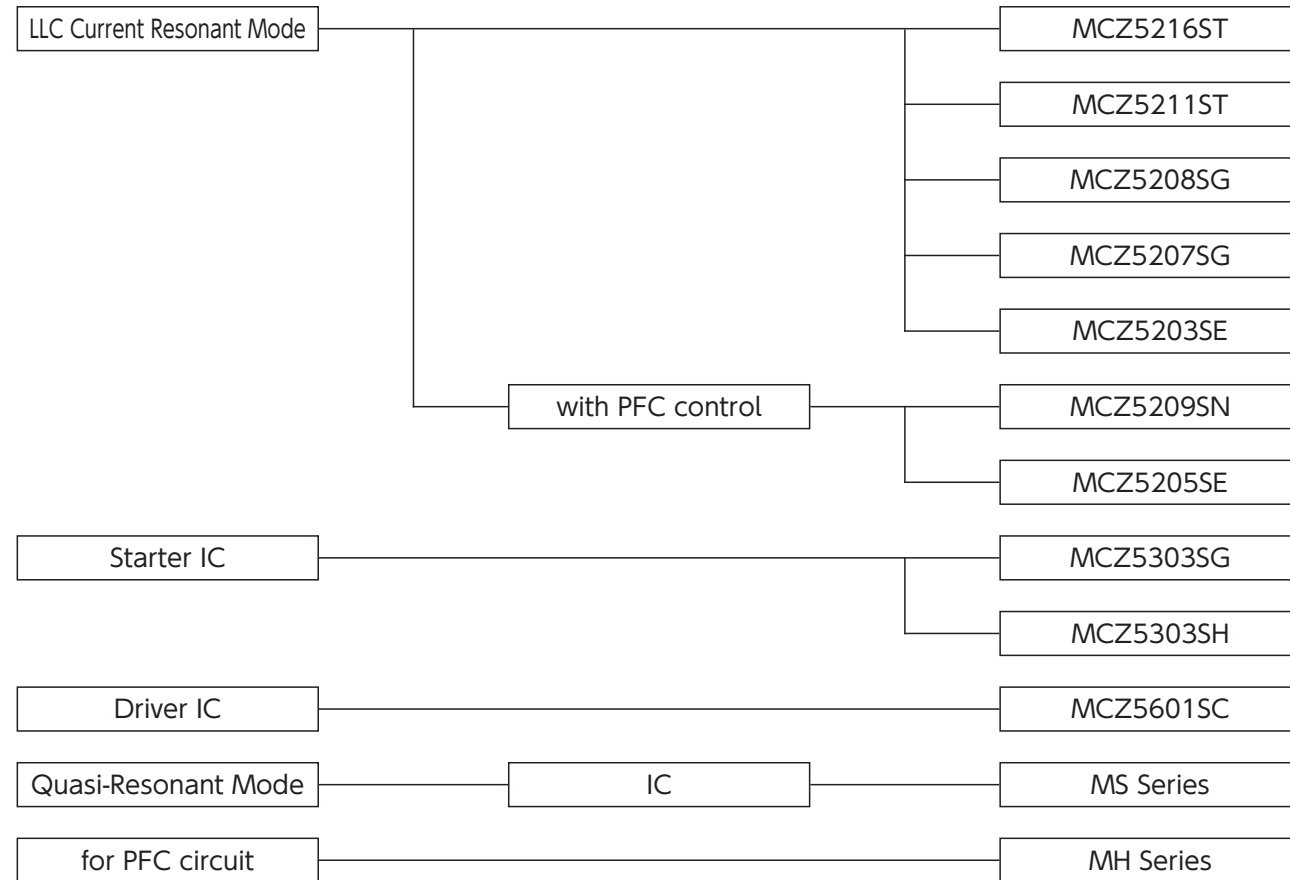



IC for LED Lighting

Critical Current Mode Power Supply ICs for LED Lighting : MV Series

- Outline The MV series has a specialized function for LED lighting with PWM & Linear dimming that operates Critical Current Mode without auxiliary winding. On and off width modulation function allows for smooth deep dimming of 1% or less.

MV Series

Critical Current Mode Power Supply ICs for LED Lighting												
Package		Type No.	HV Startup	Vcc [V]	Output	ON/OFF	Built-in Regulator Voltage [V]	Linear Dimming	PWM Dimming	Automotive		
JEDEC Code JEITA Code House Name	Fig.											
	-	SOP8J	L2	MV1001SC	Yes	9 to 16	1ch	-	-	-	-	
				MV1002SC	No						-	
				MV1011SC	Yes						-	
				MV1012SC	No						-	
	-	SOP16	L5	MV2002SG	No	10 to 16	2ch	Cont. by REF Voltage	3.3	Yes	Yes	-
				MV2052SG	No				5		-	

POWER ICs

IC for Power Supply

LLC Current Resonant Mode Controller ICs for Bridge Converter : MCZ Series

Outline The MCZ series is an advanced symmetric LLC current resonant mode controller for bridge converters. Symmetric LLC resonant converter applications are greatly expanding due to their extremely high efficiency and low noise characteristics.

Starter ICs with Built-in Burst Function : MCZ5303

Outline A dedicated IC that provides a low power consumption start-up for circuits without an IC. Low power consumption standby is possible due to the ON/OFF Control IC with burst function. It is especially effective when used in conjunction with the LLC current resonance power supply.

High/Low Side Driving IC

Outline A driving IC for MOSFET and IGBT power devices. With built-in high-withstand voltage components, it can be used for a variety of uses such as inverter and power supply, etc.





Low Power Standby Quasi-Resonant Power Supply ICs : MS Series

Outline The MS series consumes much less power in standby mode than conventional MR series. The ICs incorporate various functions to make it more user-friendly and easier to design a power supply with fewer external components.

PFC ICs : MH Series



Outline The MH series is a PFC circuit control IC which enables multistage interleave. An efficient, high power operation is possible by utilizing a slave IC composed of multistage interleave and a master IC that can be used alone.

MCZ Series

LLC Current Resonant Mode Controller ICs for Bridge Converter																											
Package		Fig.	Type No.	Type	HV Startup	High-side Drive	Vcc (max) [V]	Vin Sensing	Burst Mode	Maximum Frequency [kHz]	X-cap. discharge	Capacitive Mode Protection	Over Voltage Protection	Over Current Protection	Automotive												
JEDEC Code	JEITA Code															House Name											
	-	L6	★ MCZ5216ST	LLC Current Resonant Mode	Yes	Yes	35	Yes	Yes	500	Yes	Yes	Latch	Timer Latch	-												
	-		MCZ5211ST	LLC Current Resonant Mode	Yes				Yes	500	No				-												
	-	L8	MCZ5209SN	LLC Current Resonant Mode with PFC Control	Yes				Yes	35	Yes				Yes	300	No	Yes	Latch	Timer Latch	-						
	-		MCZ5207SG	LLC Current Resonant Mode	No										Yes	300	No				-						
	-	L5	MCZ5208SG	LLC Current Resonant Mode	No										Yes	35	Yes				Yes	500	No	Yes	Latch	Timer Latch	-
	-		MCZ5205SE	LLC Current Resonant Mode with PFC Control	No																No	300	No				-
	-	L7	MCZ5205SE	LLC Current Resonant Mode with PFC Control	No	Yes	35	Yes				No	300	No							Yes	Latch	Timer Latch				-
	-		MCZ5203SE	LLC Current Resonant Mode	No							No	300	No													-

★ : New product

Starter ICs with Built-in Burst Function

Package		Fig.	Type No.	Vin Applied Voltage [V]	Vcc Output Voltage [V]	HV Startup	Vin Sensing	Burst Mode	Automotive
JEDEC Code	JEITA Code								
	-	L5	MCZ5303SG	95 to 450	18.5(typ)	Yes	Yes	Yes	-
	-		MCZ5303SH				No	No	-
	-	L3	MCZ5303SH						



High/Low Side Driver ICs

Package		Fig.	Type No.	Output	High-side Floating Supply Voltage [V]	Vcc (max) [V]	Input/Output Channel	Vcc_UVLO [V]	VBS_UVLO [V]	Typ. Output Current		Automotive
JEDEC Code	JEITA Code									House Name	Source [mA]	
	-	L2	★ MCZ5601SC	High-side/Low-side	600	22	2/2	8.2 to 9.0	7.2 to 8.0	400	400	-

★ : New product

MS Series

Low Power Standby Quasi-Resonant Power Supply ICs

Package		Fig.	Type No.	Vin [V]	Vcc [V]	Over Voltage Protection	Over Current Protection	Stand-by Operation	Bottom Skip	Automotive
JEDEC Code	JEITA Code									
	-	L3	★ MS1007SH	95 to 450	11 to 21	Auto restart	Auto restart	Auto Burst Mode	1 skip	-
	-		MS1004SH					Auto Burst Mode/ S-Stby Mode	2 skip	-
	-		MS1003SH					Auto Burst Mode/ S-Stby Mode	1 skip	-
	-	L4	MS1006SK	11 to 24	Vcc Latch	Timer Latch 2sec. (typ)	Auto Burst Mode/ UT-Stby Mode	2 skip	-	
	-		MS1005SK				Auto Burst Mode/ UT-Stby Mode	1 skip	-	











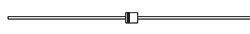

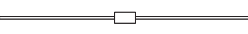
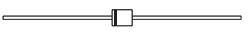
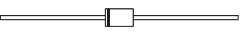
★ : Under development

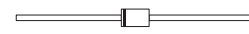
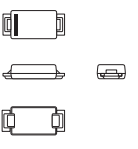
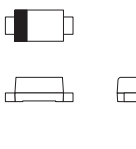
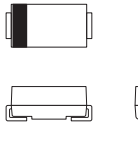
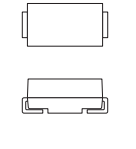
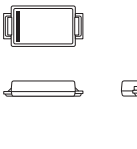
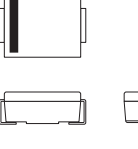
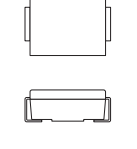
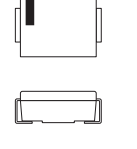
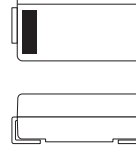
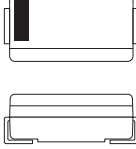
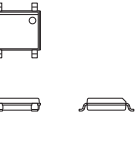
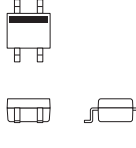
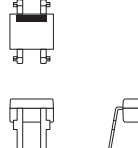
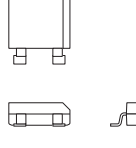
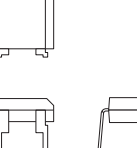
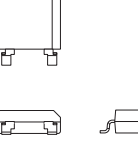
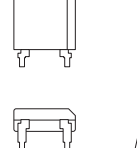
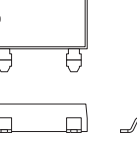
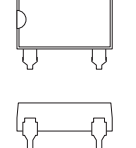
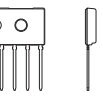
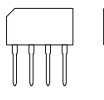
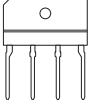
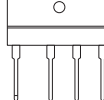
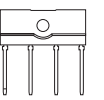
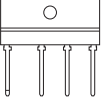
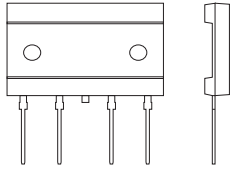
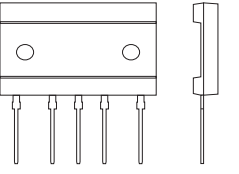
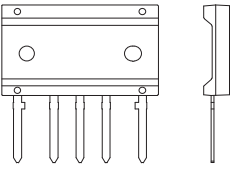
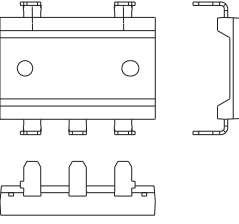
MH Series

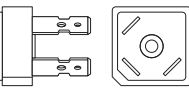
PFC ICs

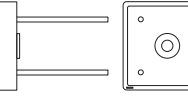
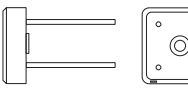
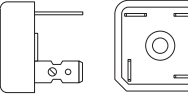
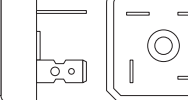
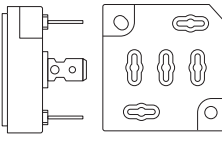
Package		Fig.	Type No.	Type	Operation Mode	Vin Sensing	Vcc [V]	Zero Current Detection	Diodes Short Protection	FB Open Short Protection	Over Voltage Protection	Automotive
JEDEC Code	JEITA Code											
	-	L2	MH2501SC	Critical Current Mode	Master	Unnecessary	13 to 23	Auxiliary Winding	Yes	Yes	Yes	-
	-		MH2511SC	Synchronizes with Master IC	Slave		11 to 23	-	No	No	No	-

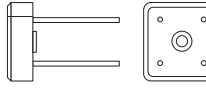
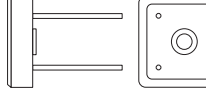
PACKAGE LIST

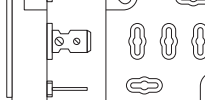
	1	2	3	4	5		6	7	8	9	10
A	A1 Package:AX057 	A2 Package:AX06 	A3 Package:AX06 	A4 Package:AX078 	A5 Package:AX10 		A6 Package:AX10 	A7 Package:AX14 			
B	B1 Package:DO-219AB similar <small>GE</small> 	B2 Package:DO-219AA <small>ME</small> 	B3 Package:DO-214AC <small>IE</small> 	B4 Package:DO-214AC <small>IE</small> 	B5 Package:SC-110B <small>CE</small> 		B6 Package:DO-214AA similar <small>ME</small> 	B7 Package:DO-214AA similar <small>ME</small> 	B8 Package:DO-214AA similar <small>ME</small> 	B9 Package:2F 	B10 Package:2F 
C	C1 Package:SOPA-4 	C2 Package:TO-269AA <small>IZ(SMD)</small> 	C3 Package:1Z(DIP) 	C4 Package:1N(SMD) 	C5 Package:1N(DIP) 		C6 Package:1NA(SMD) 	C7 Package:1NA(DIP) 	C8 Package:1W(SMD) 	C9 Package:1W(DIP) 	
D	D1 Package:D3K 	D2 Package:2S 	D3 Package:3S 	D4 Package:5S 	D5 Package:JB 		D6 Package:JA 	D7 Package:TSB(4pin),JC(4pin) 	D8 Package:TSB(5pin),JC(5pin) 	D9 Package:JF 	D10 Package:JH 
E	E1 Package:MCP 	E2 Package:D30VC 	E3 Package:S2VB 	E4 Package:S4VB 	E5 Package:S5VB 		E6 Package:S10VB 	E7 Package:S15VB 	E8 Package:S25VB 	E9 Package:S50VB 	E10 Package:S3WB 
	11	12	13	14	15						
E	E11 Package:S10WB 	E12 Package:S15WB 	E13 Package:S20WB 	E14 Package:SVTA 	E15 Package:SVT 						

PACKAGE LIST

PACKAGE LIST

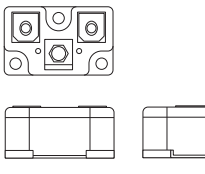
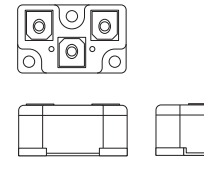
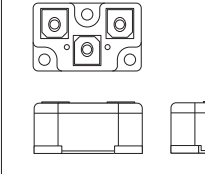
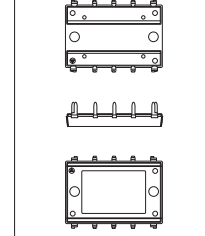
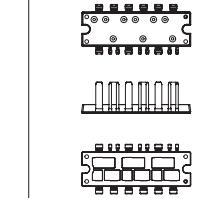
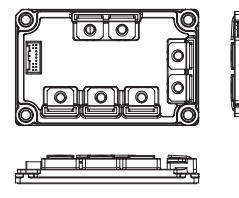
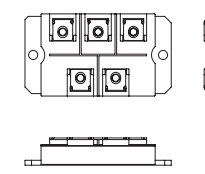
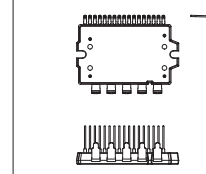
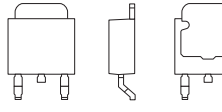
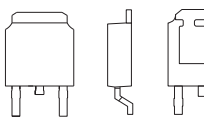
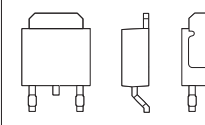
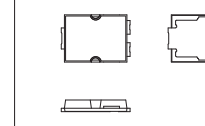
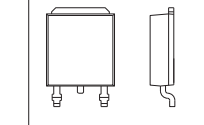
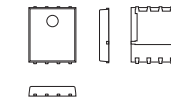
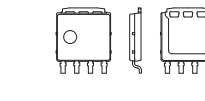
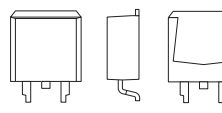
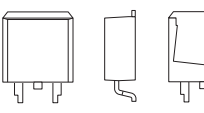
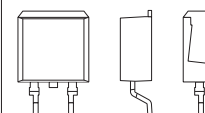
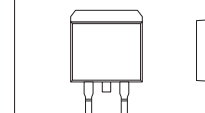
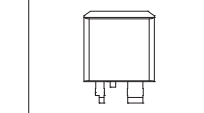
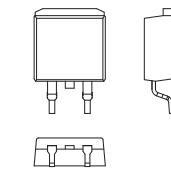
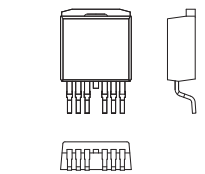
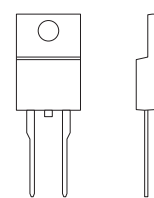
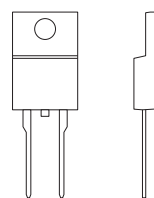
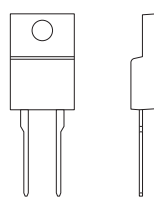
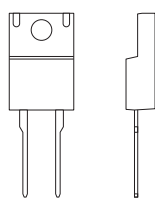
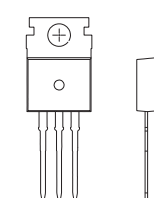
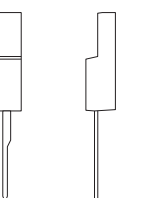
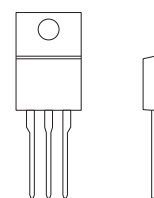
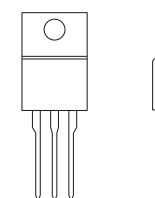
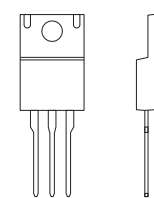
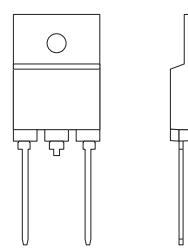
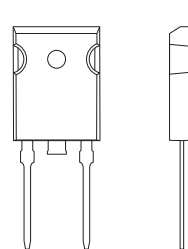
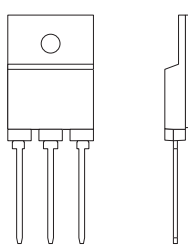
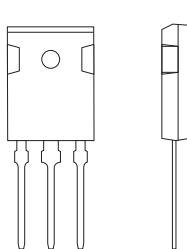
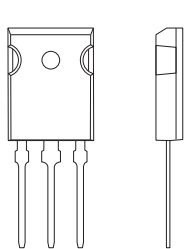
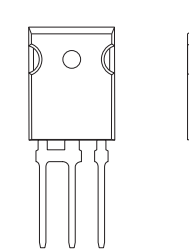
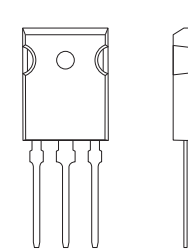
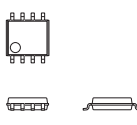
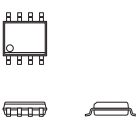
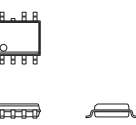
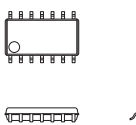
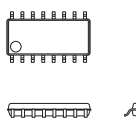
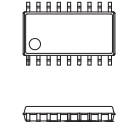
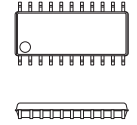
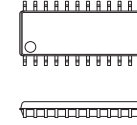
	1	2	3	4	5	6	7	8	9	10
F	F1 Package:Module 	F2 Package:Module 	F3 Package:Module 	F4 Package:MG001 	F5 Package:MG031 	F6 Package:MG032 	F7 Package:MG038 	F8 Package:MG048 		
G	G1 Package:SC-63 Epack 	G2 Package:TO-252AA EB 	G3 Package:TO-252AB similar EB 	G4 Package:DO-277A similar EZ 	G5 Package:TO-252AA similar EB 	G6 Package:LA 	G7 Package:MO-235B similar LE 			
H	H1 Package:SC-83 similar STQ-220 	H2 Package:SC-83 similar EB 	H3 Package:TO-263AB-1 EB 	H4 Package:TO-263AB EZ 	H5 Package:SC-83 similar EB 	H6 Package:TO-263AB EZ 	H7 Package:TO-263-SC EZ-2R 			
J	J1 Package:SC-91A FTO-220(2pin) 	J2 Package:SC-91 FTO-220A(2pin) 	J3 Package:SC-91 FTO-220AG(2pin) 	J4 Package:SC-91 FTO-220S(2pin) 	J5 Package:TO-220AB EA 	J6 Package:SC-91A FTO-220(3pin) 	J7 Package:SC-91 FTO-220A(3pin) 	J8 Package:SC-91 FTO-220AG(3pin) 	J9 Package:SC-91 FTO-220G(3pin) 	
K	K1 Package:SC-93 FTO-3P(2pin) 	K2 Package:TO-247AD MTO-3P(2pin) 	K3 Package:SC-93 FTO-3P(3pin) 	K4 Package:TO-247AD MTO-3P(3pin) 	K5 Package:TO-247AD MTO-3P(3pin) 	K6 Package:TO-247AD MTO-3P 	K7 Package:TO-247AD MTO-3P 			
L	L1 Package:SOP8 	L2 Package:SOP8J 	L3 Package:SOP8/7J 	L4 Package:SOP14 	L5 Package:SOP16 	L6 Package:SOP18 	L7 Package:SOP22 	L8 Package:SOP24 		

OUTLINE DIMENSIONS

[Unit:mm]

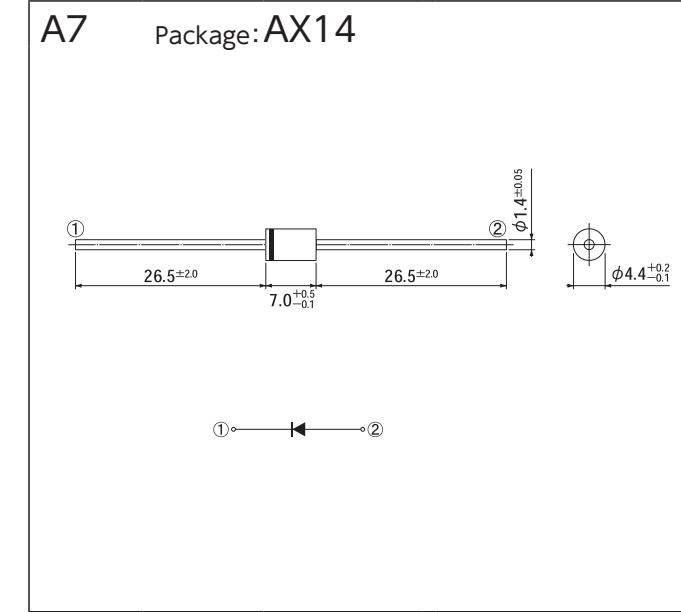
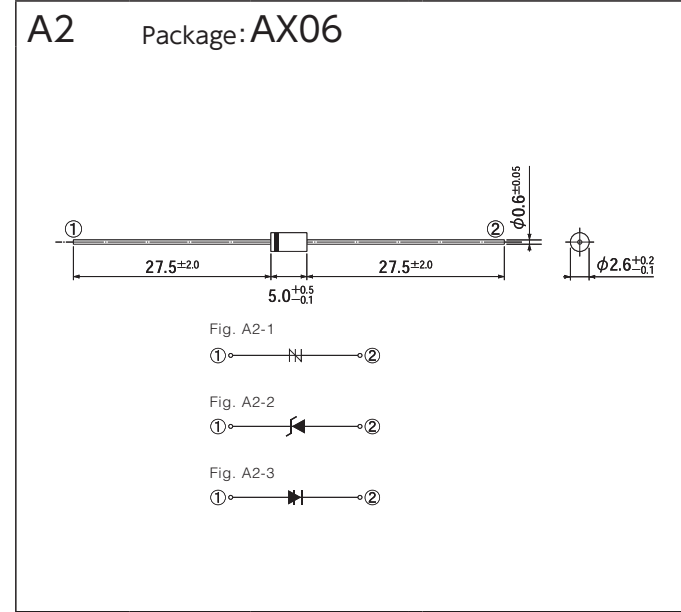
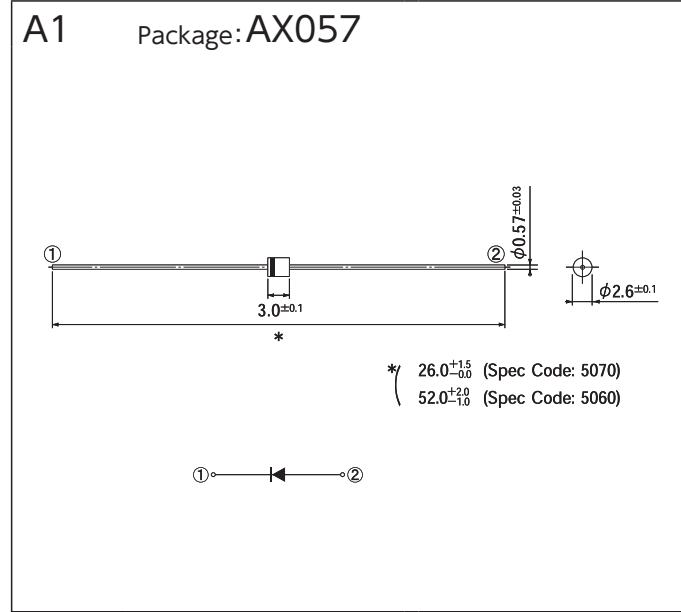

[Unit:mm]

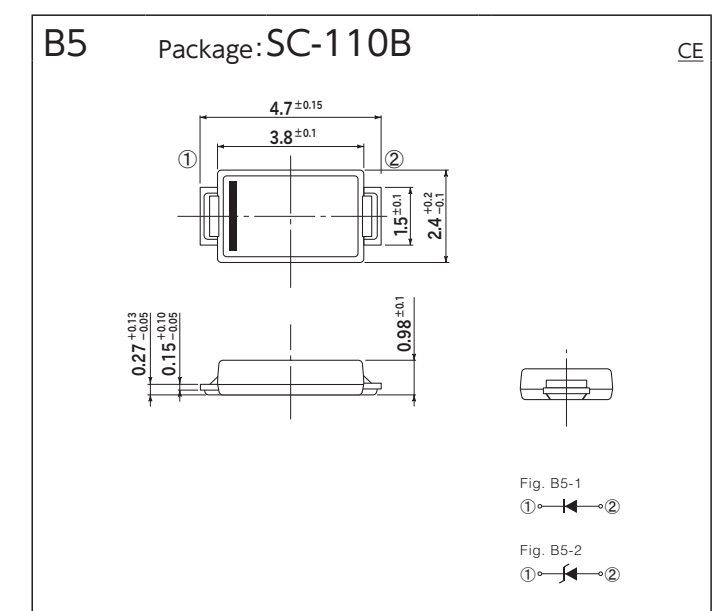
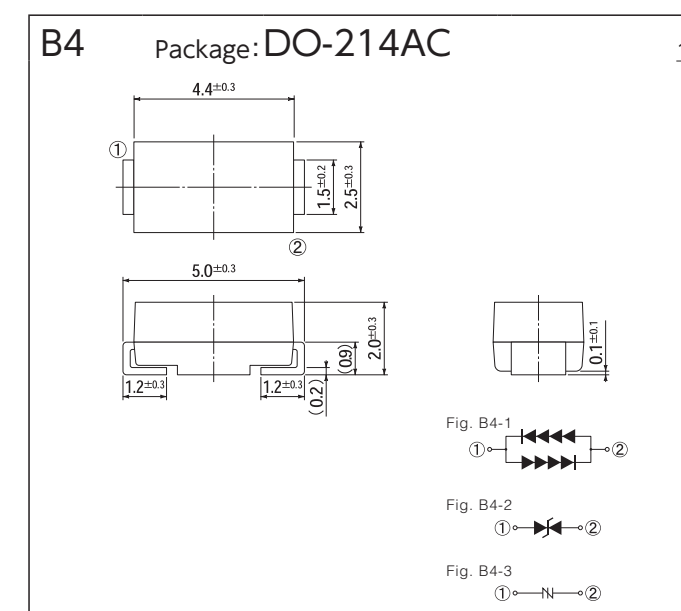
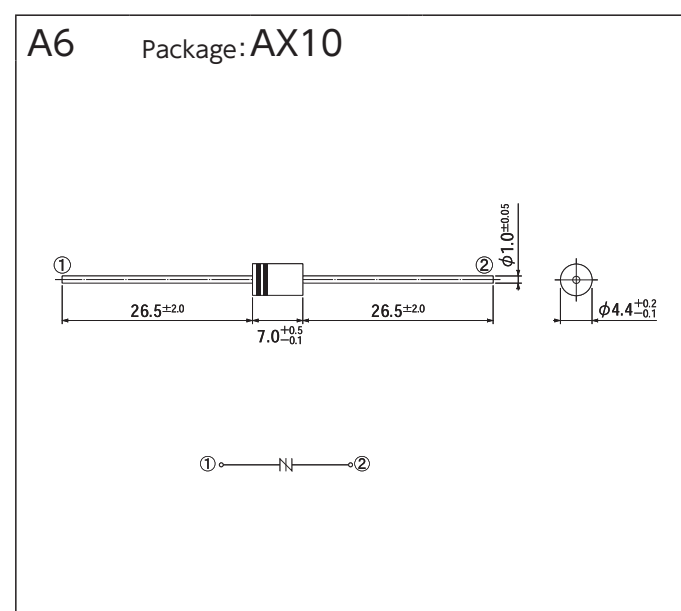
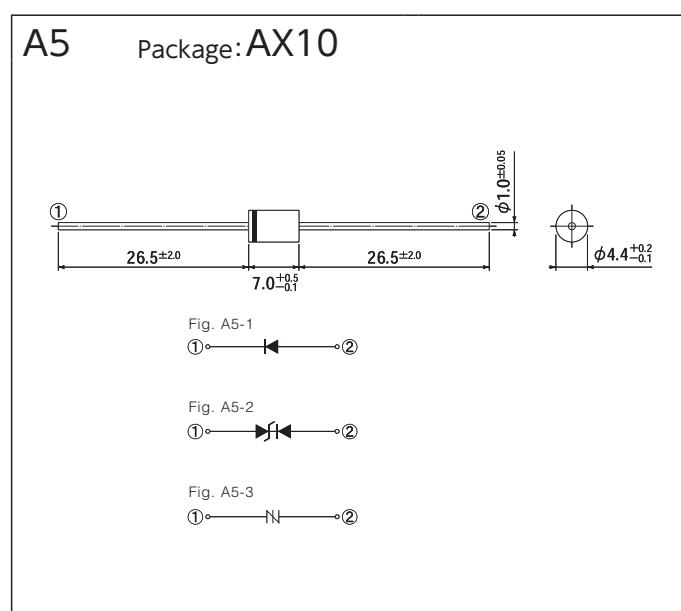
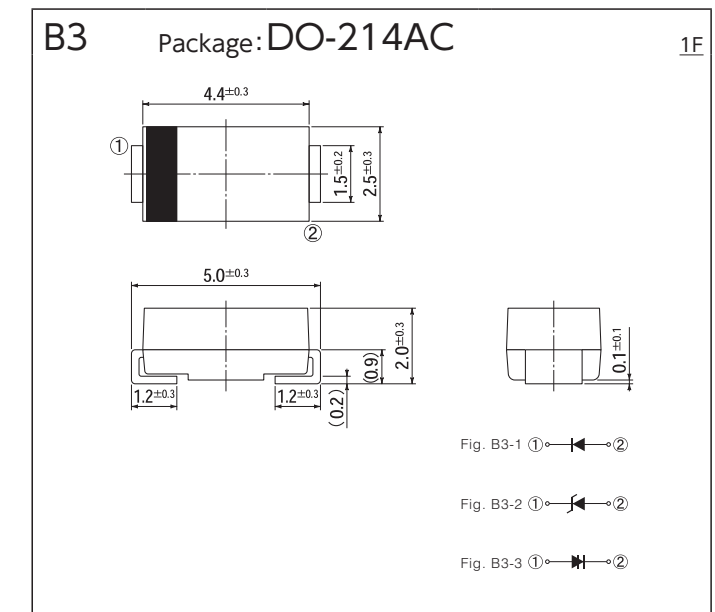
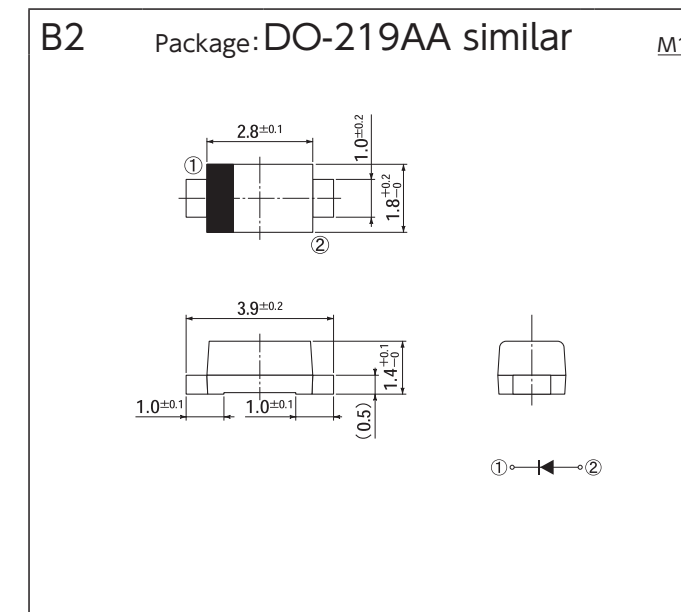
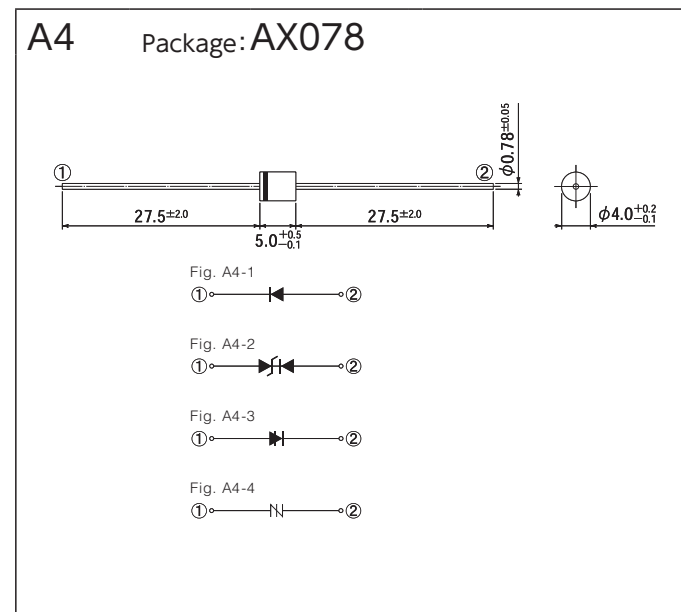
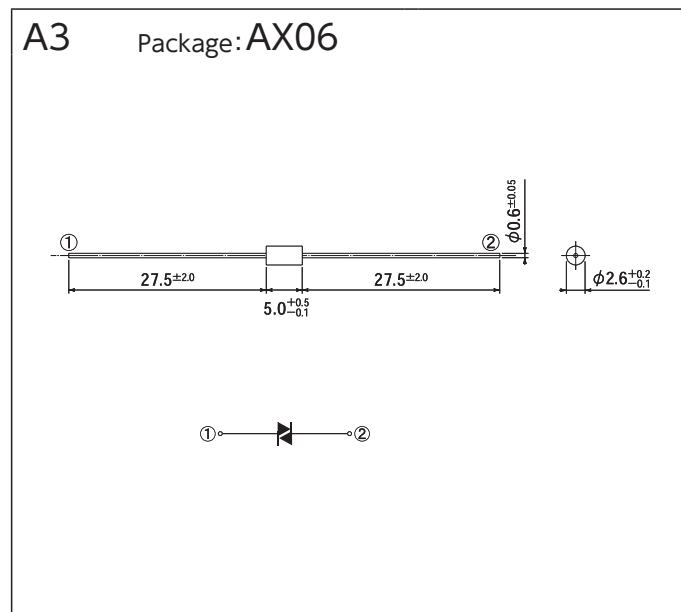
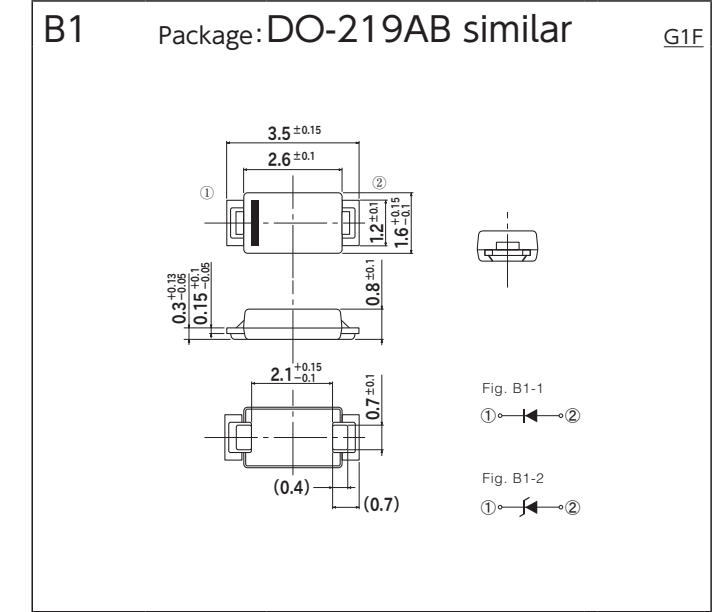

OUTLINE DIMENSIONS

OUTLINE DIMENSIONS

[Unit:mm]

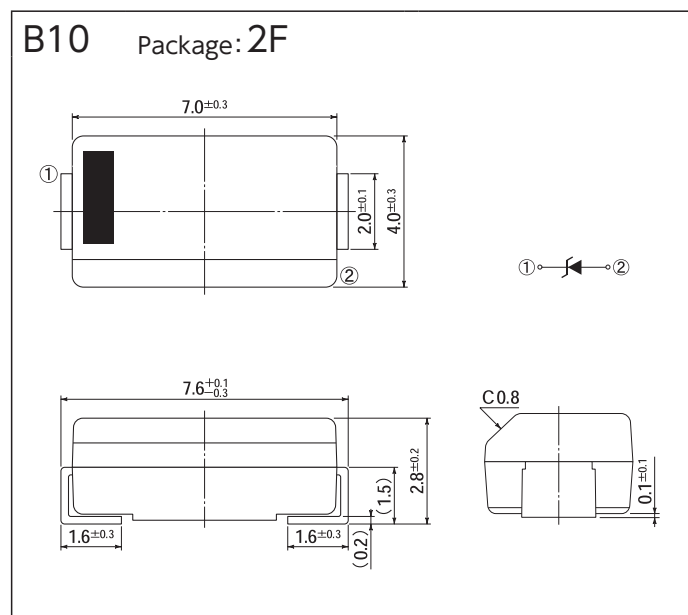
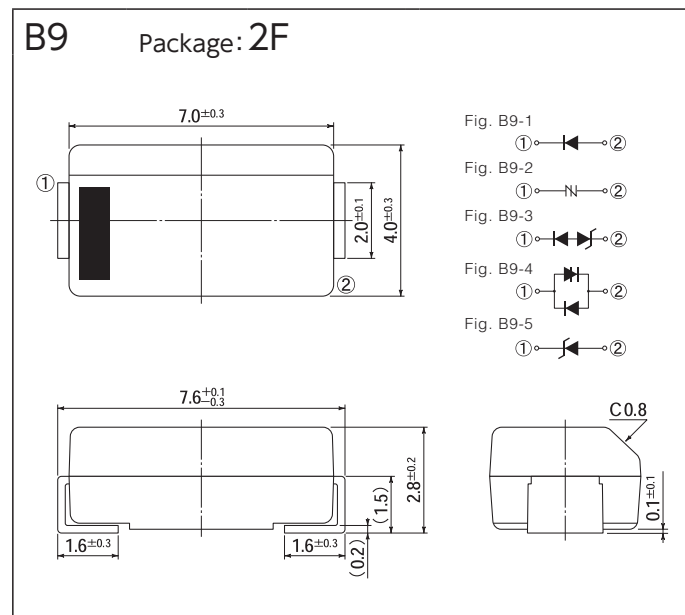
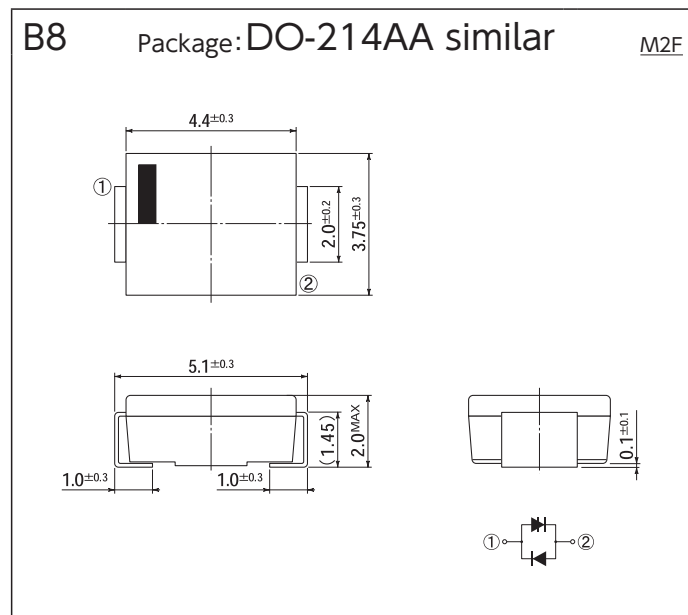
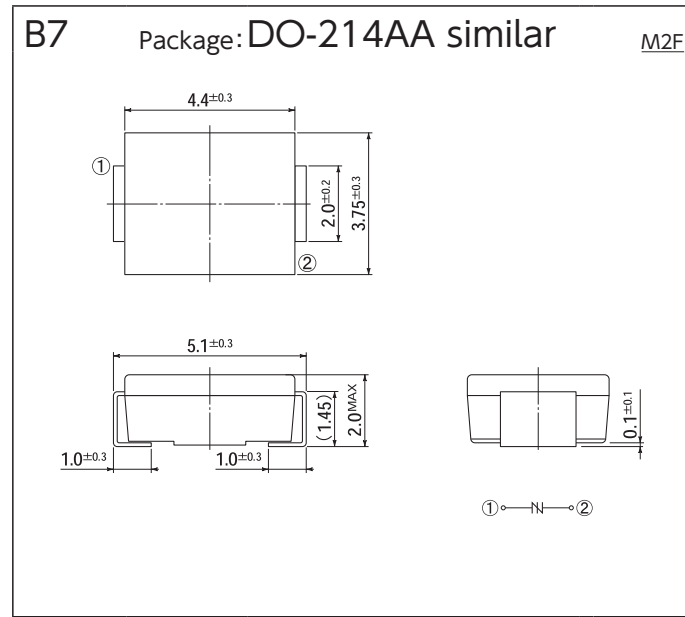
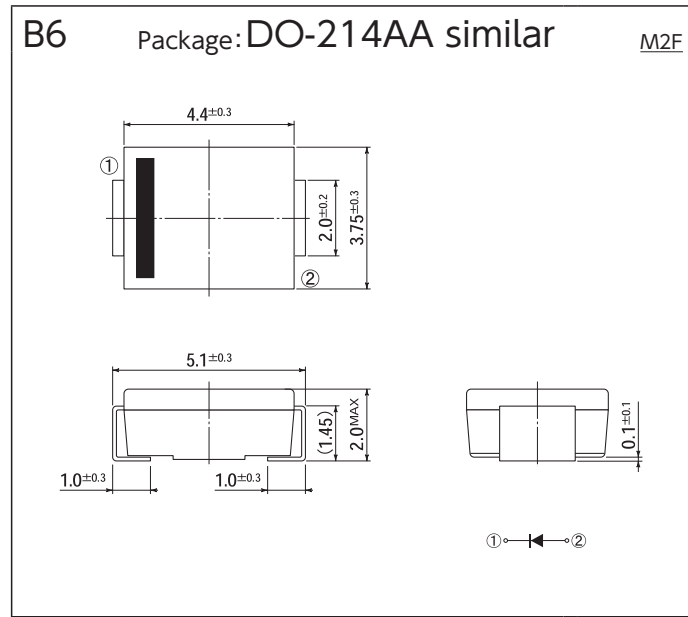

[Unit:mm]

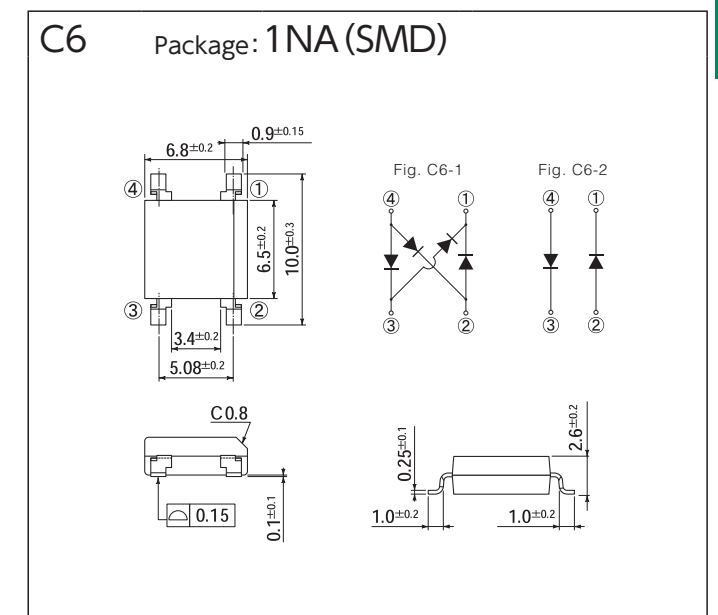
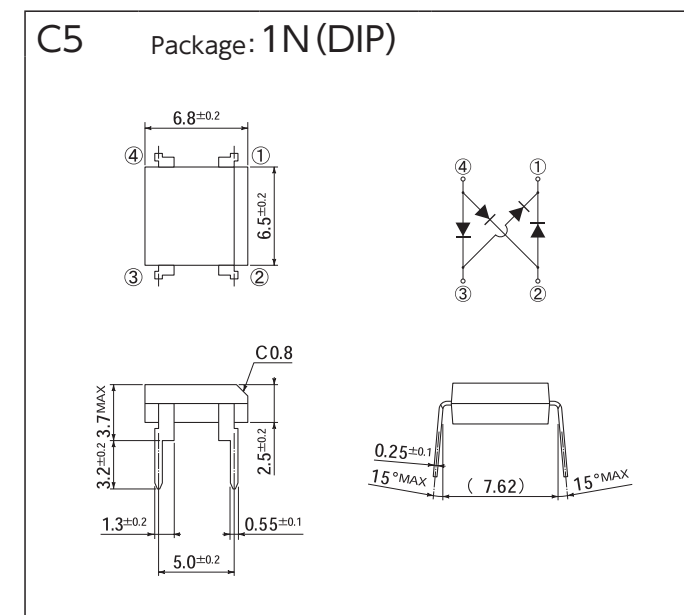
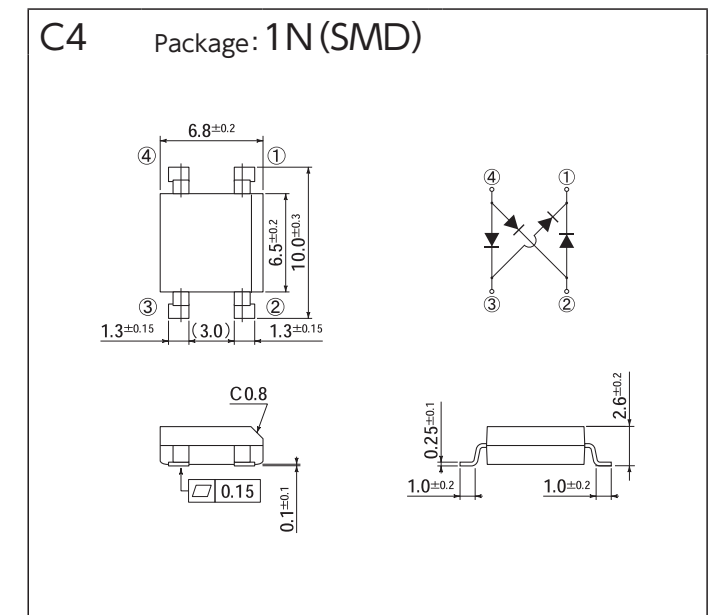
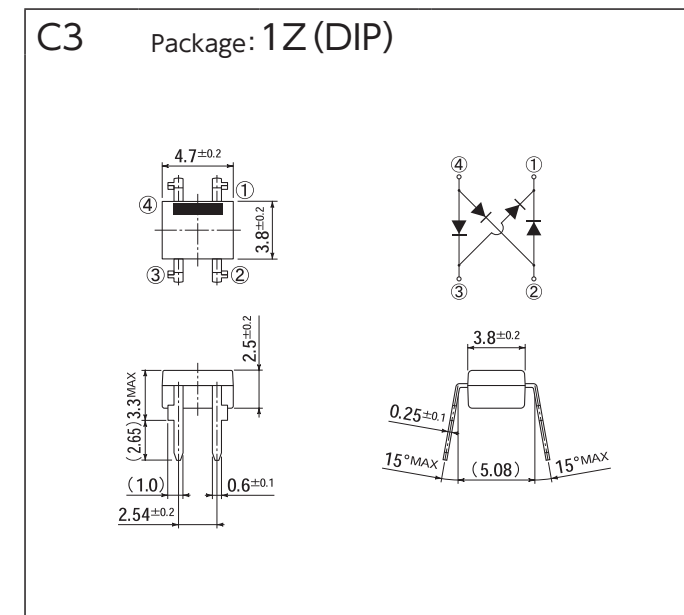
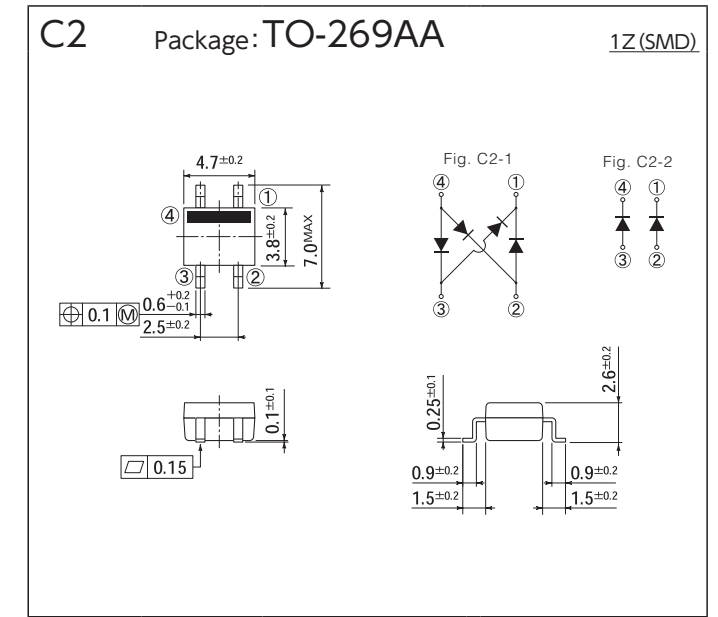
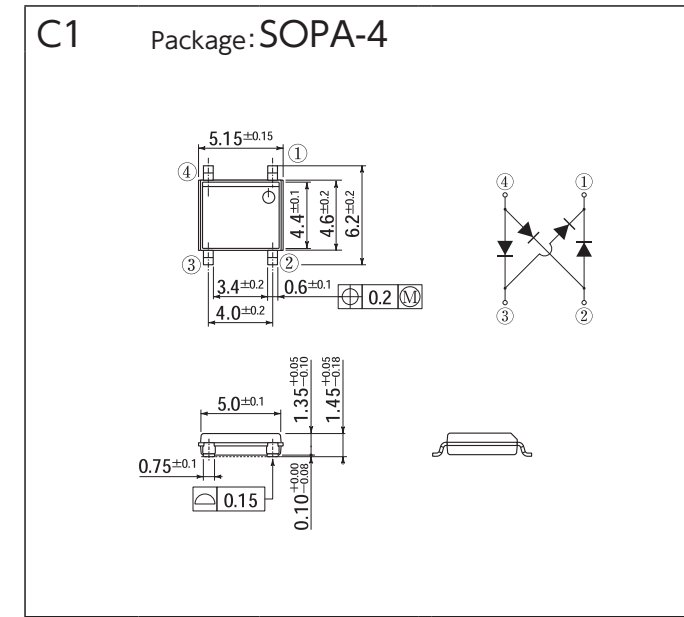

OUTLINE DIMENSIONS

[Unit:mm]

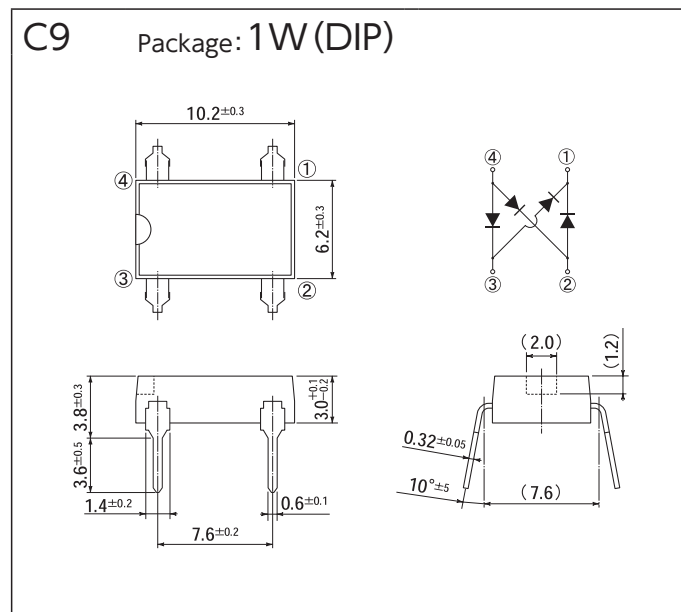
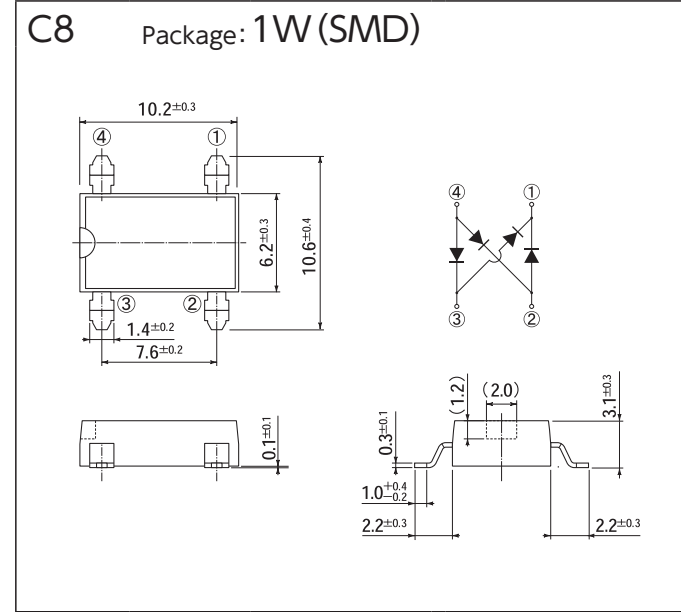
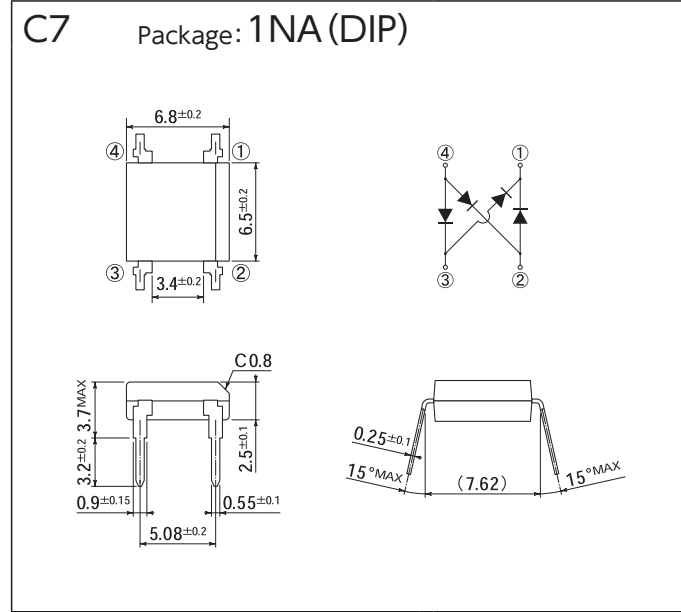

[Unit:mm]

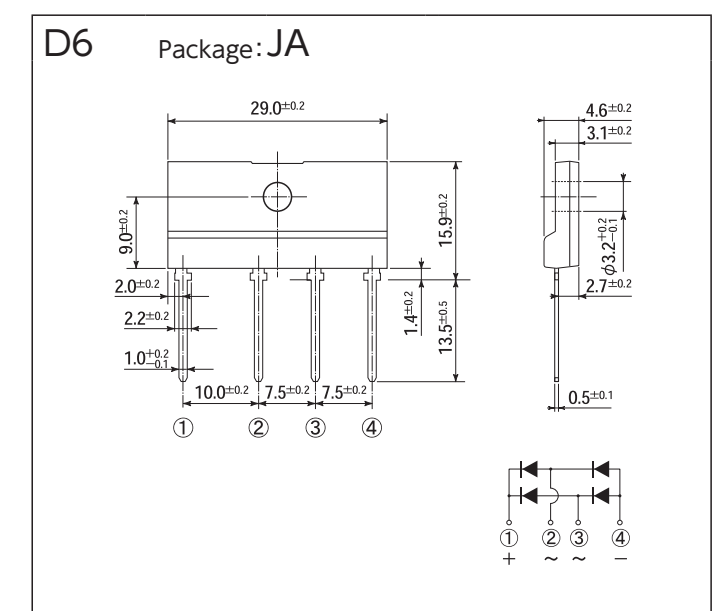
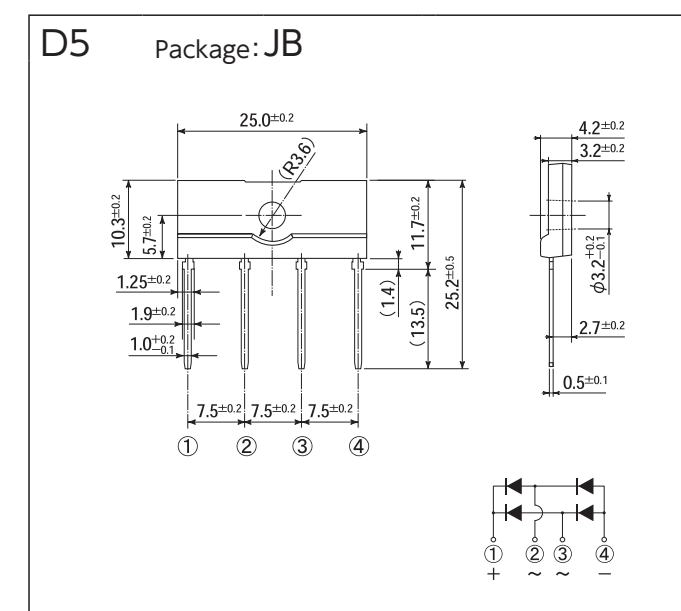
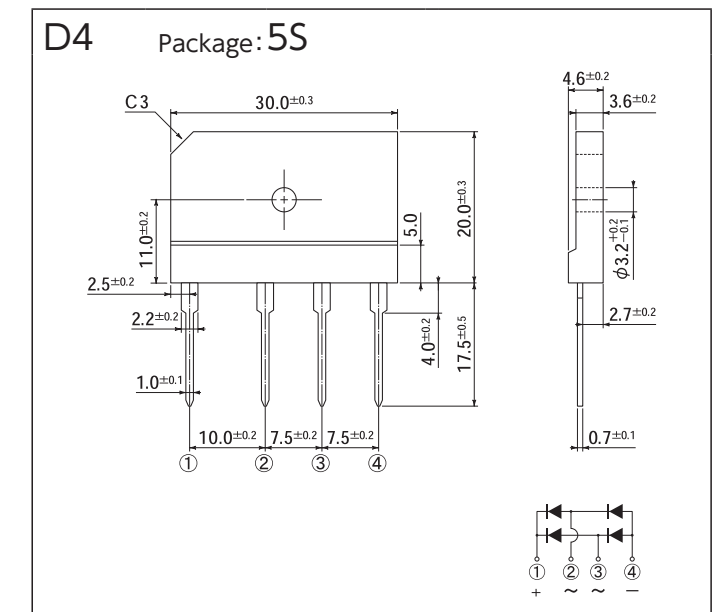
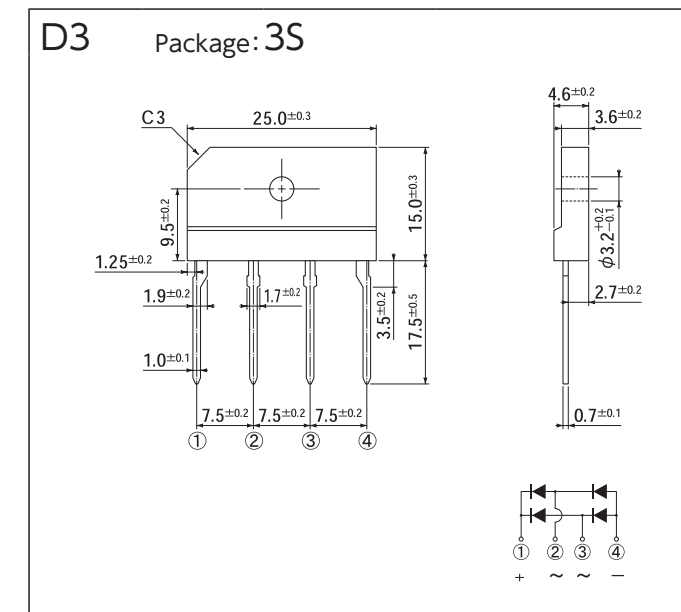
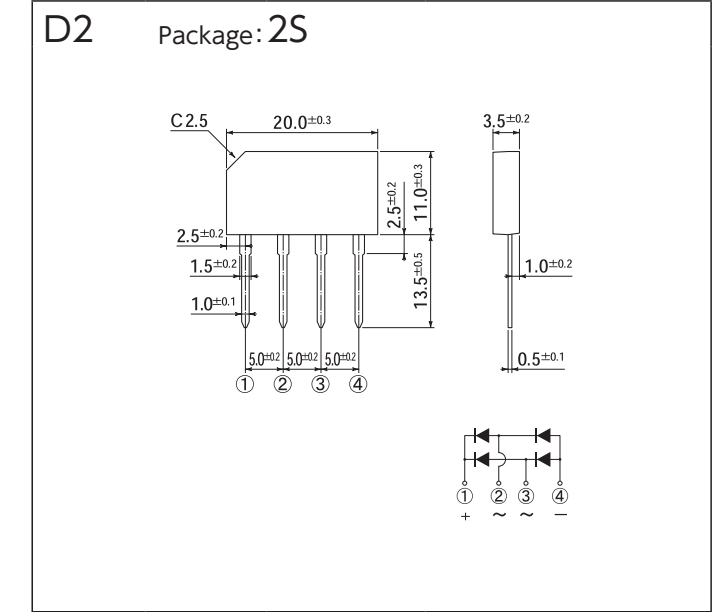
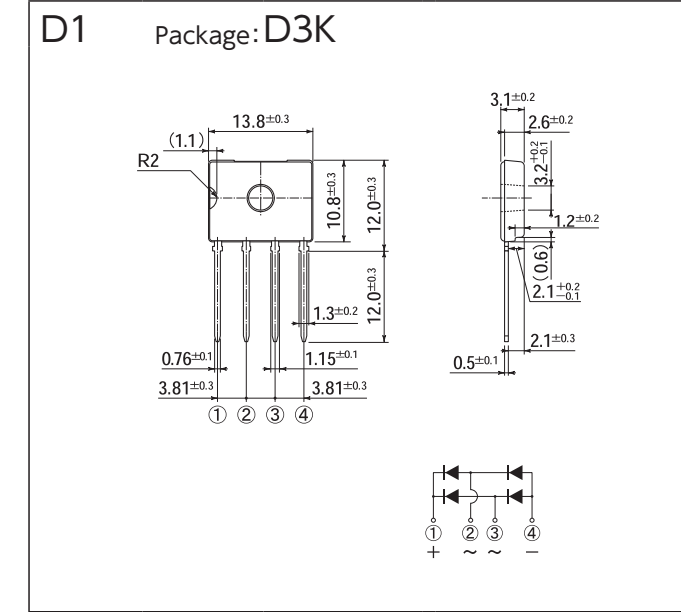

OUTLINE DIMENSIONS

[Unit:mm]

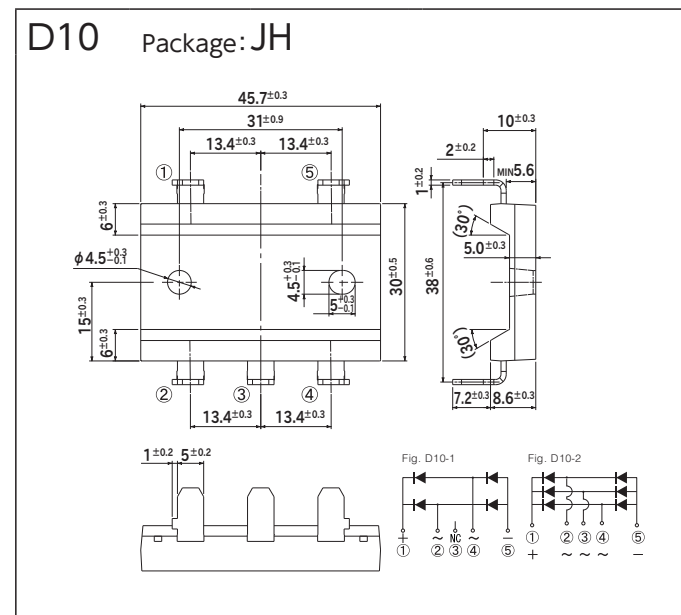
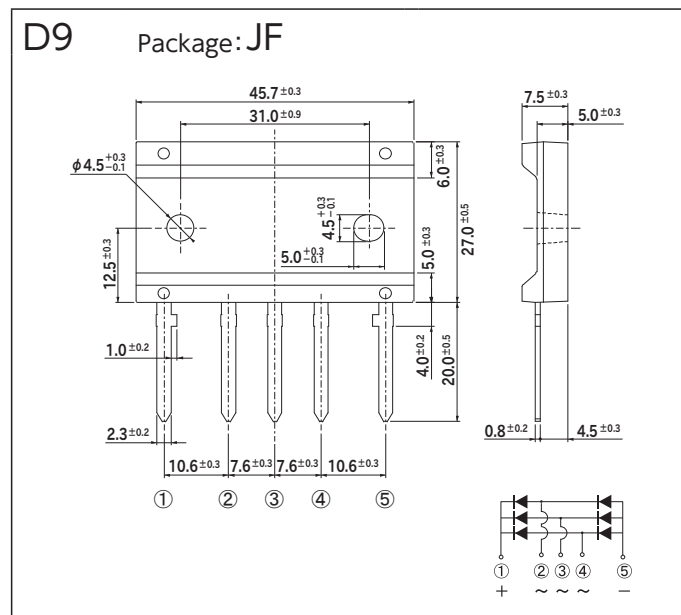
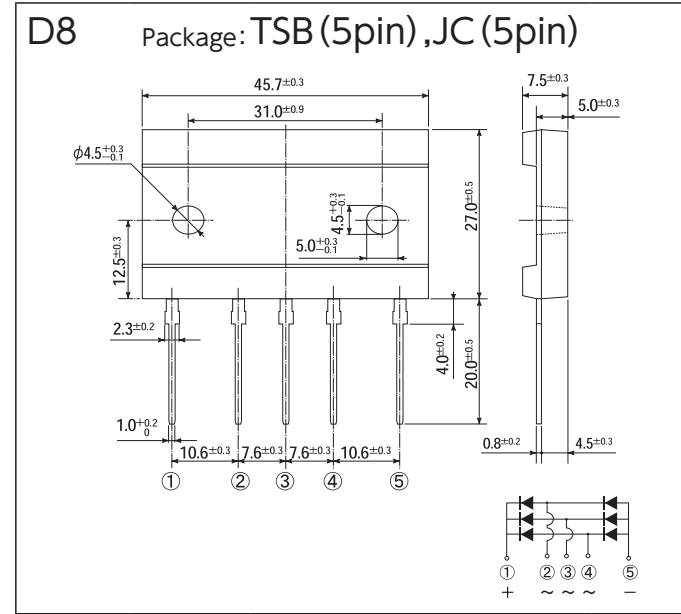
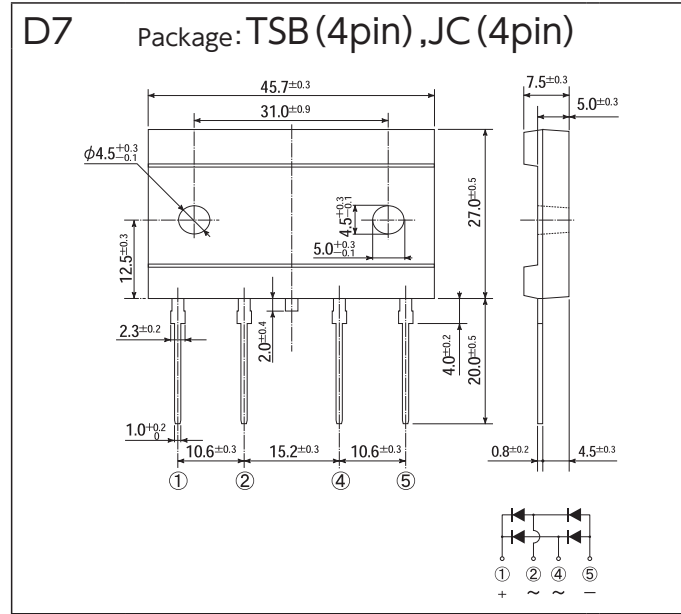

[Unit:mm]

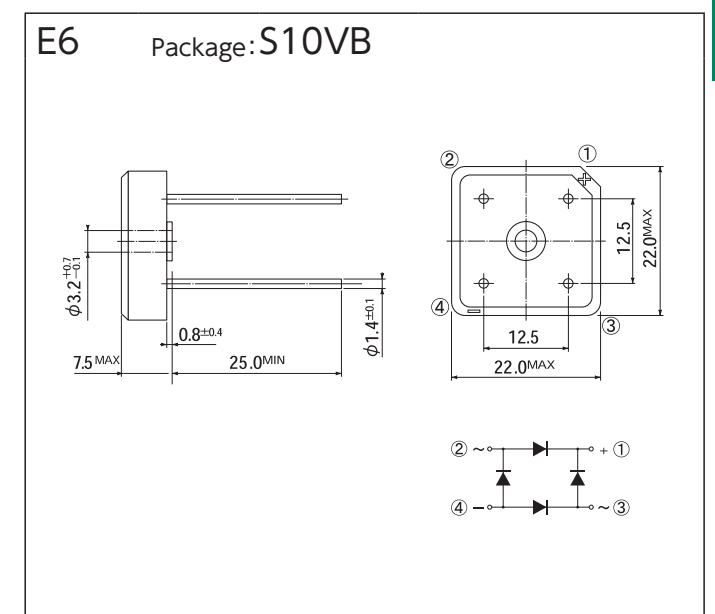
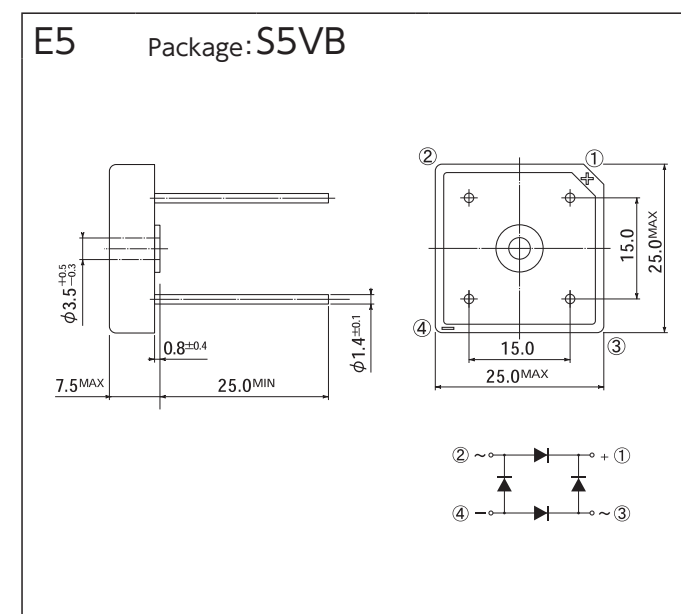
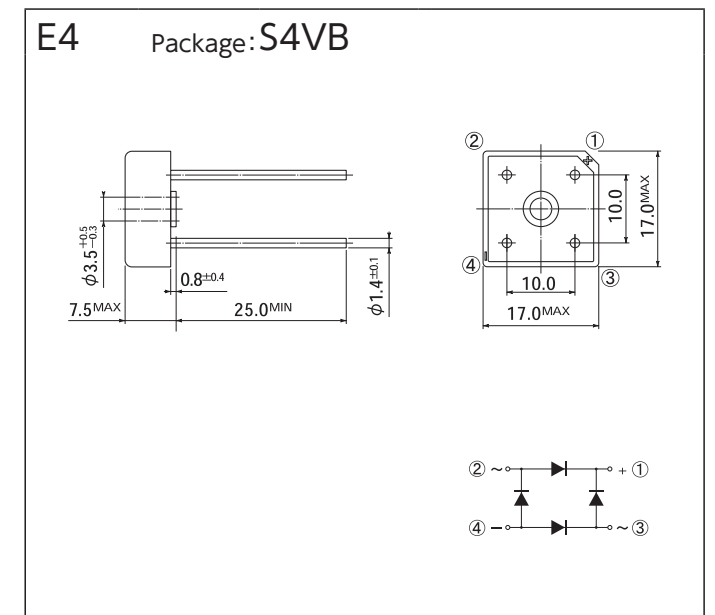
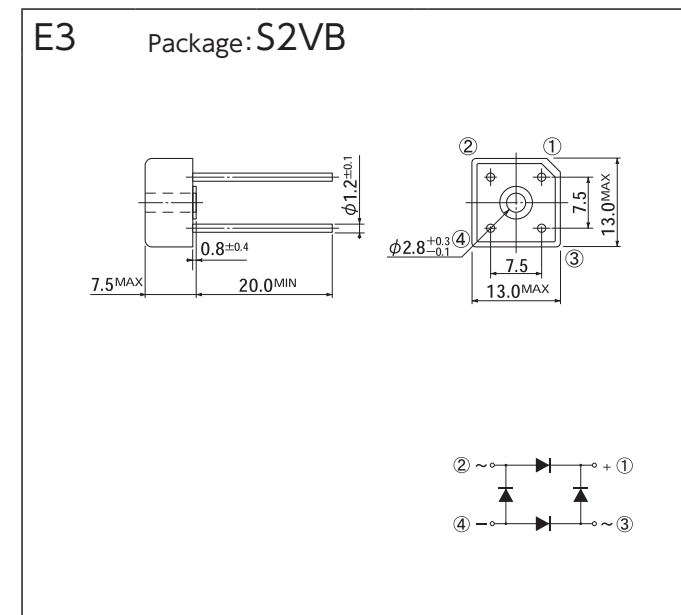
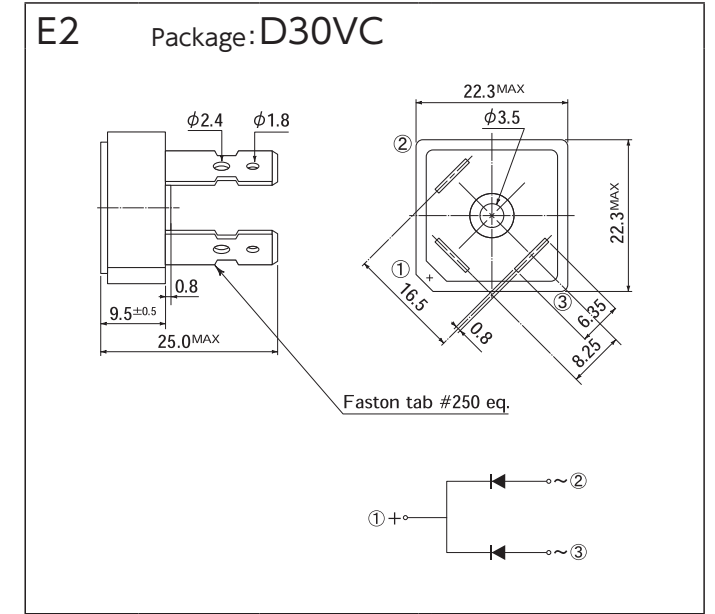
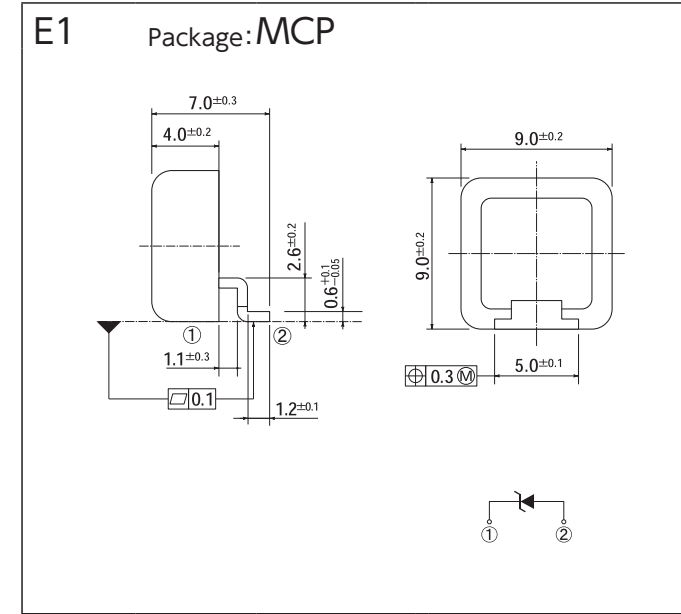

OUTLINE DIMENSIONS

OUTLINE DIMENSIONS

[Unit:mm]

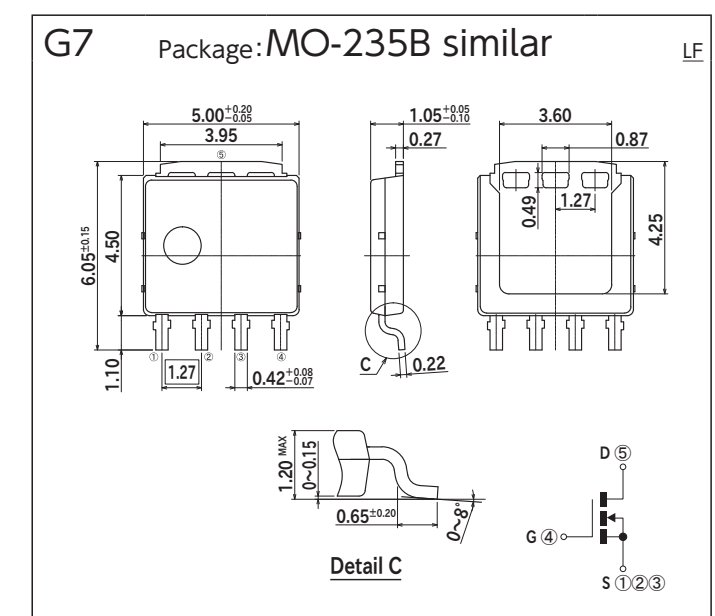
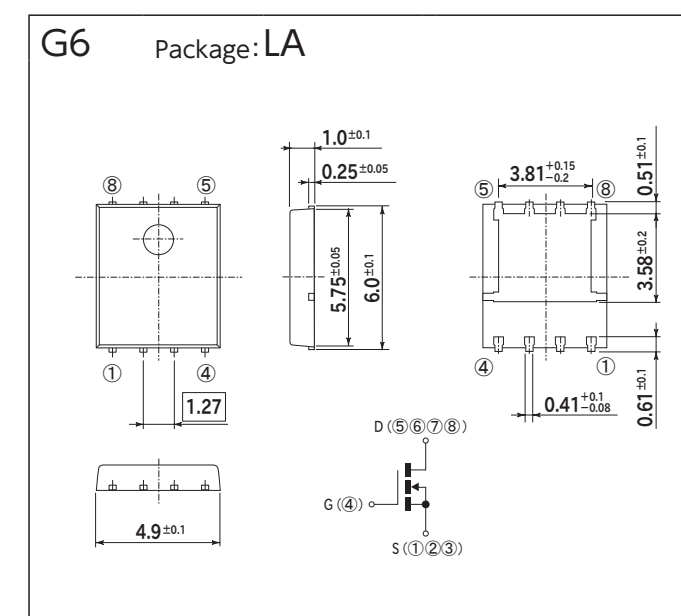
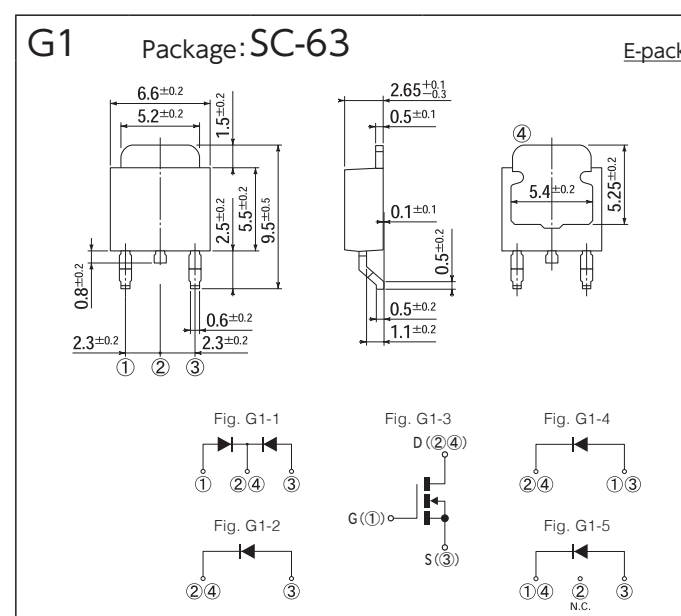
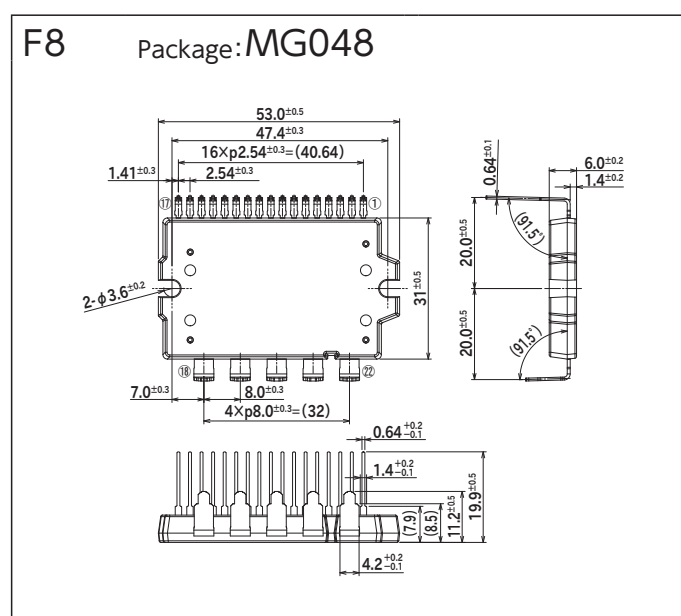
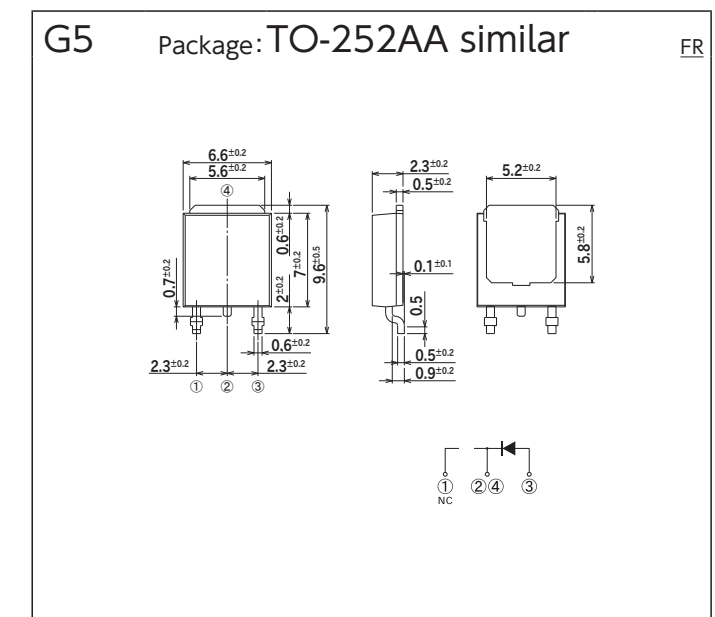
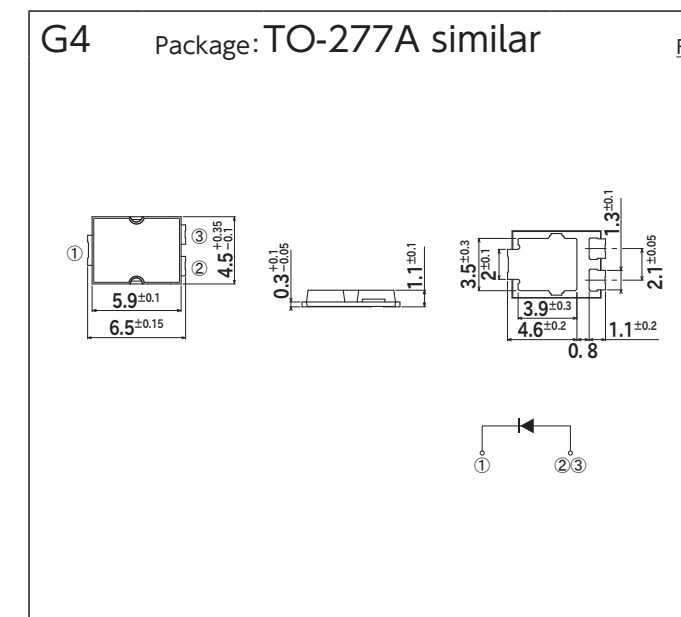
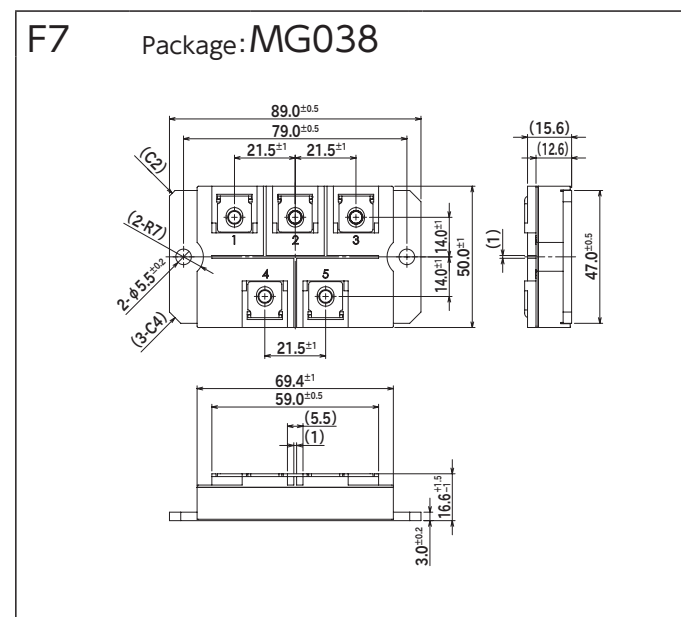
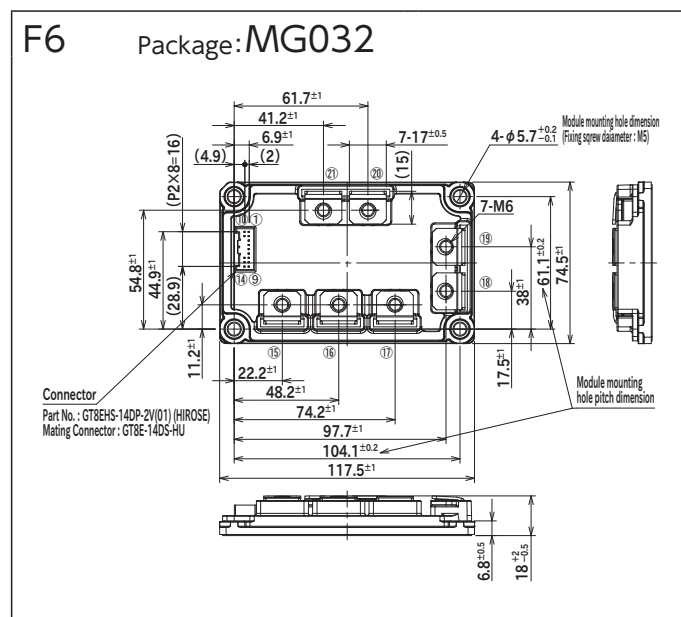
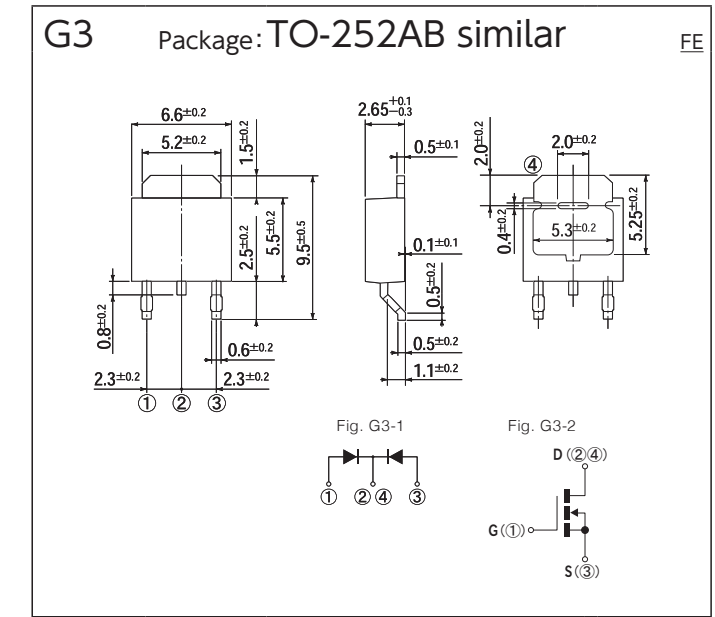
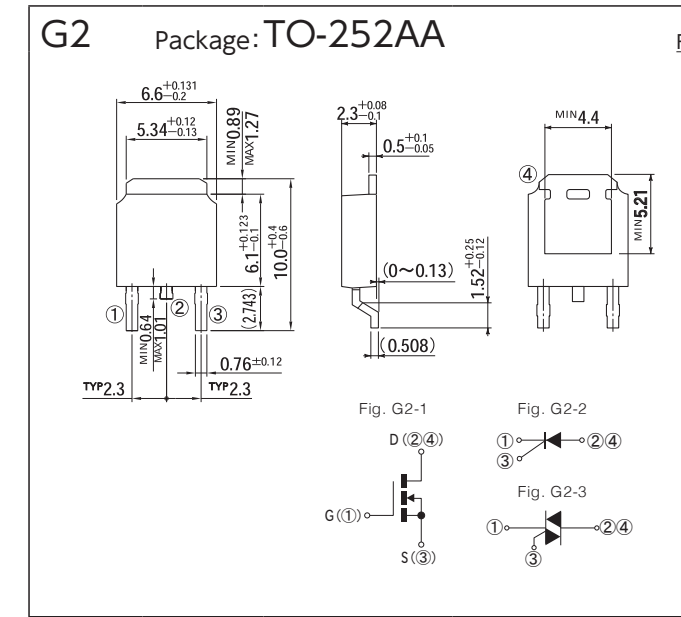
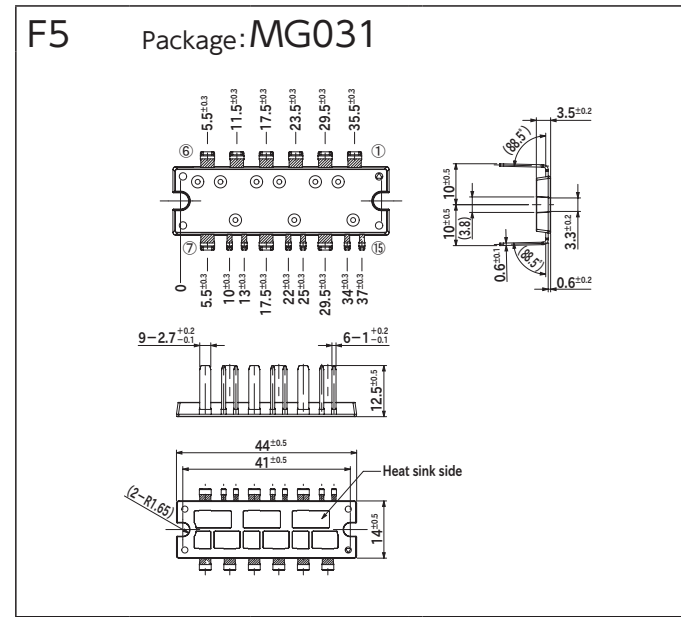
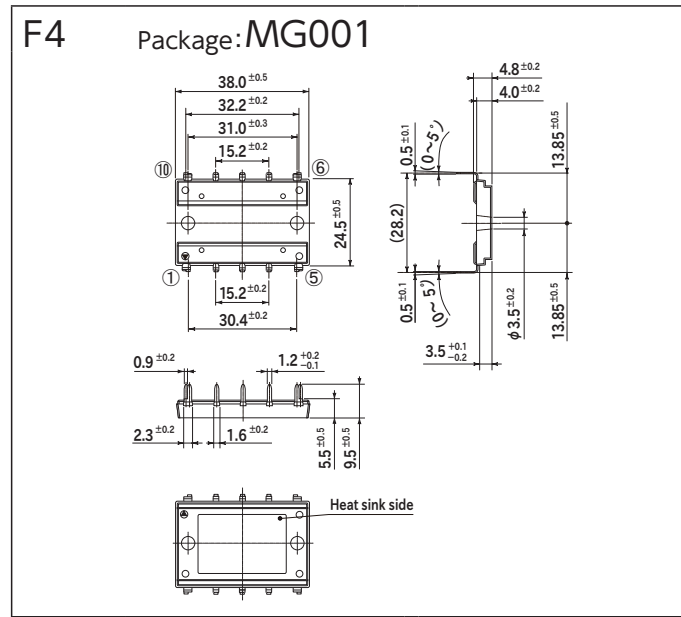

OUTLINE DIMENSIONS

[Unit:mm]

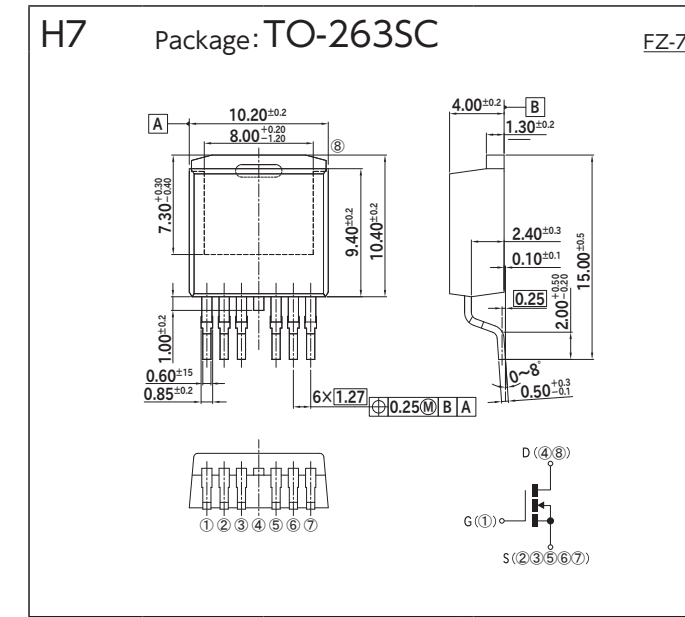
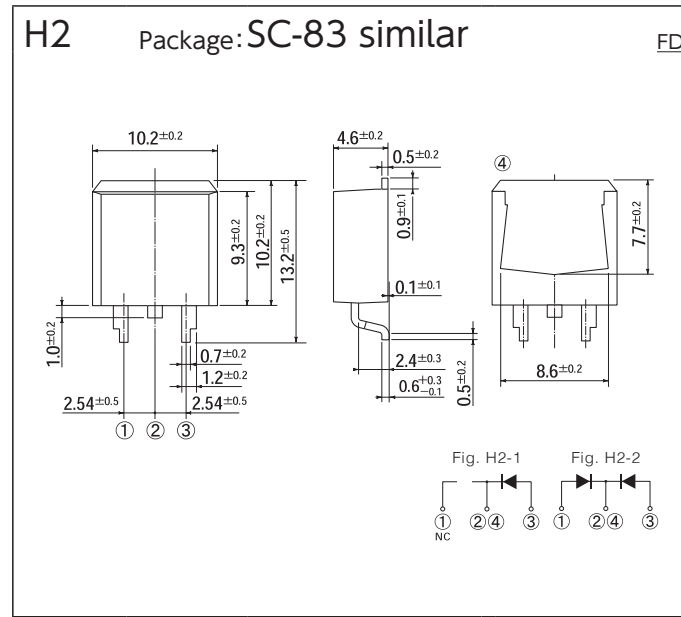
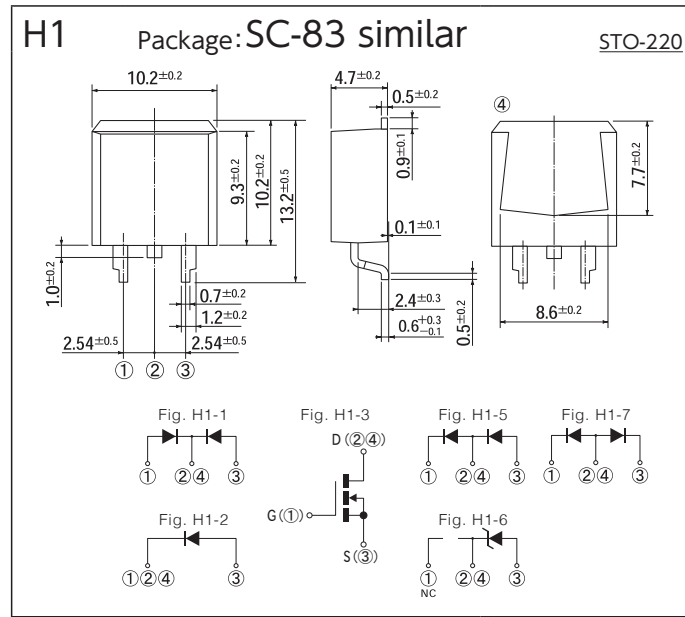

[Unit:mm]

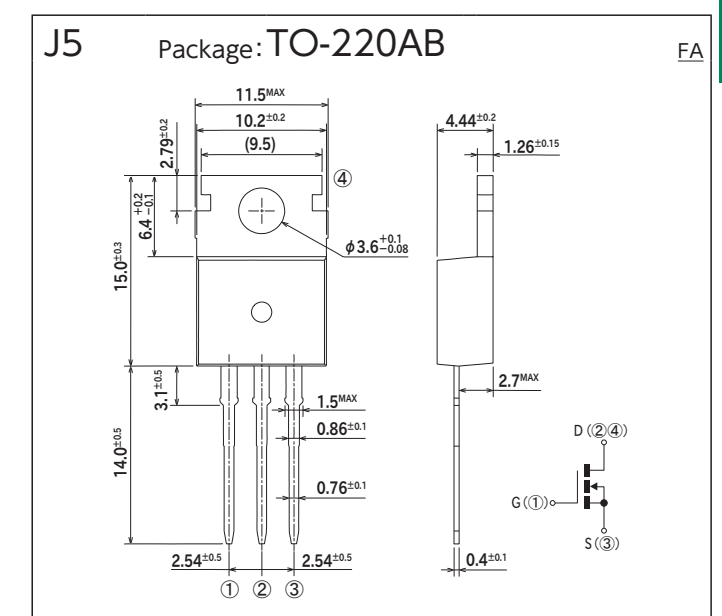
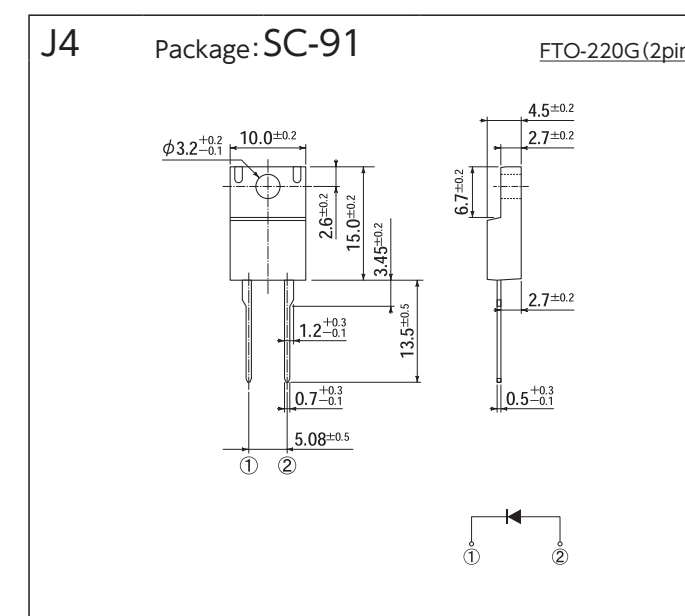
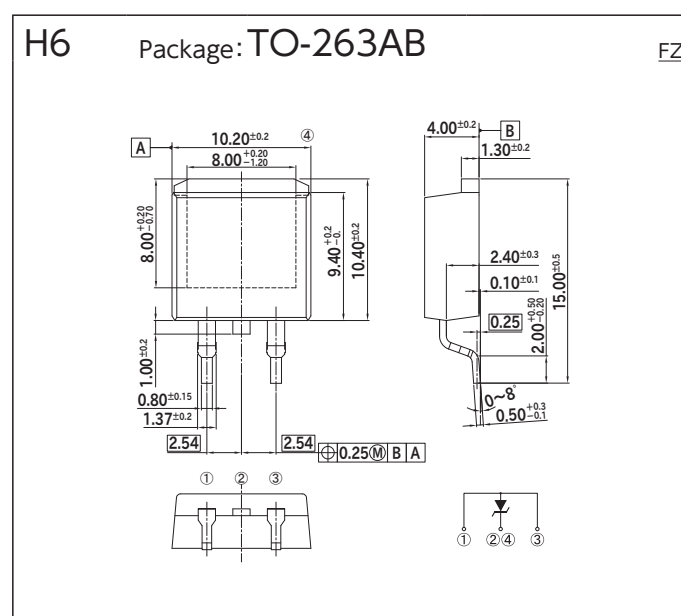
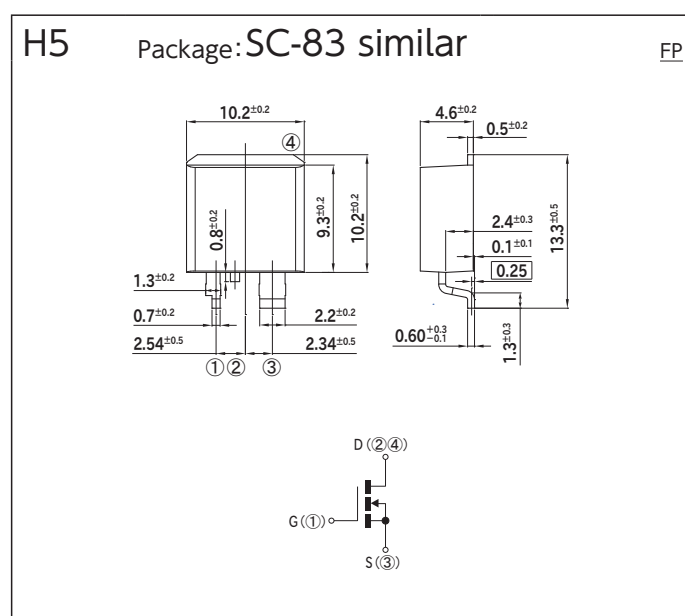
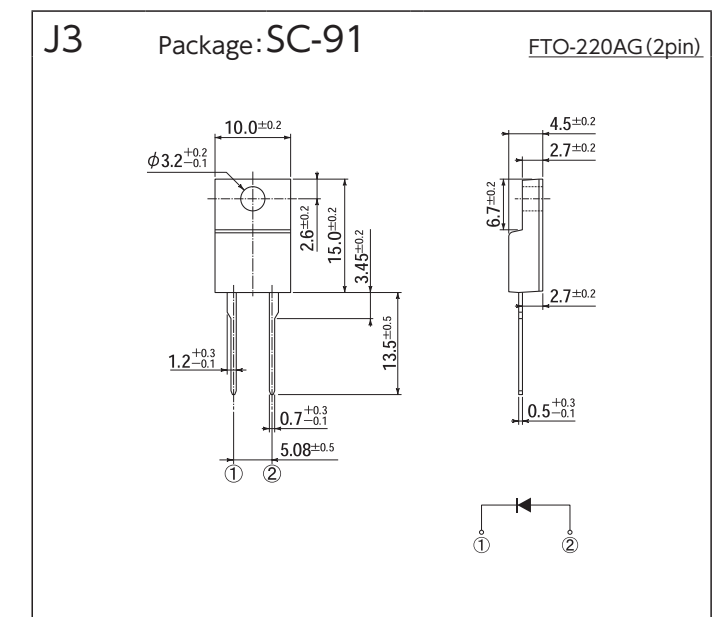
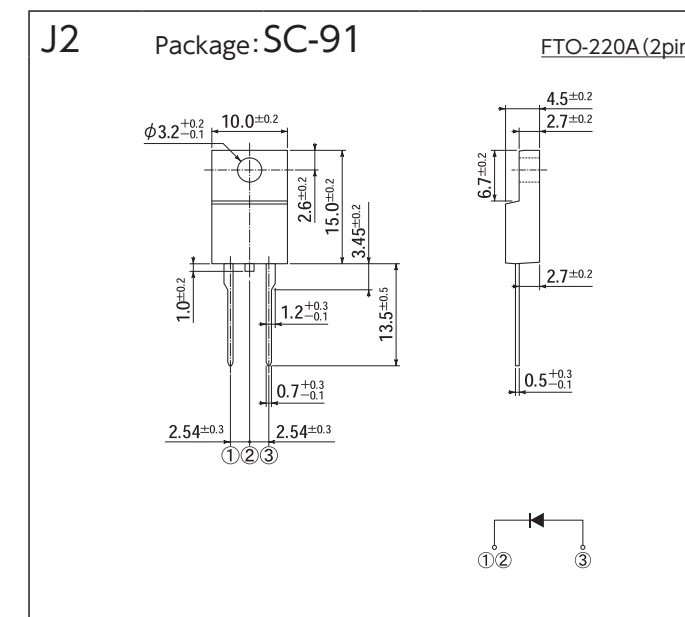
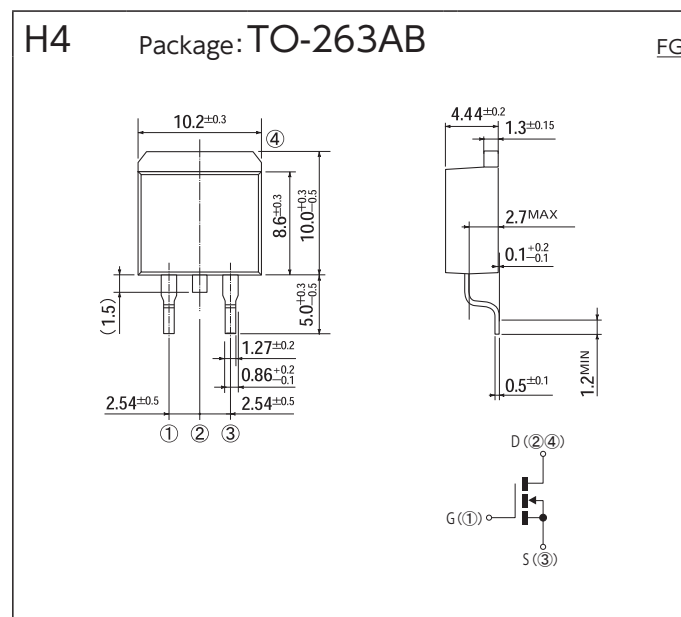
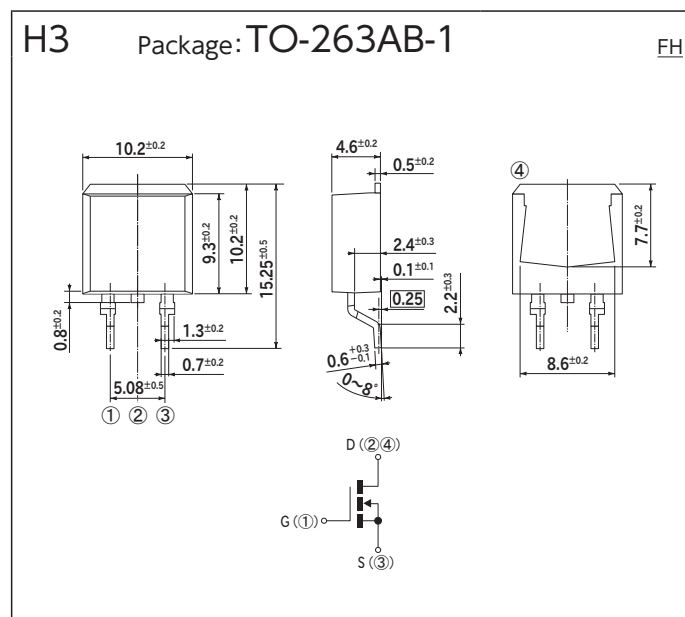
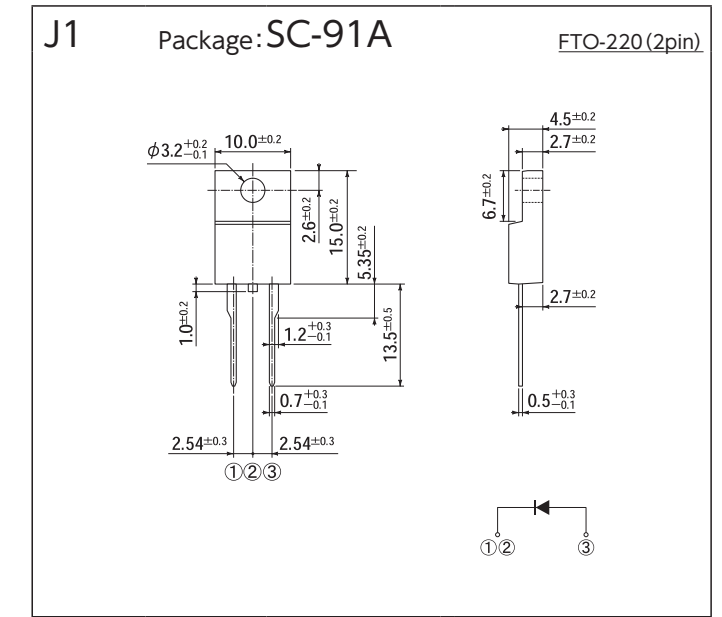

OUTLINE DIMENSIONS

[Unit:mm]

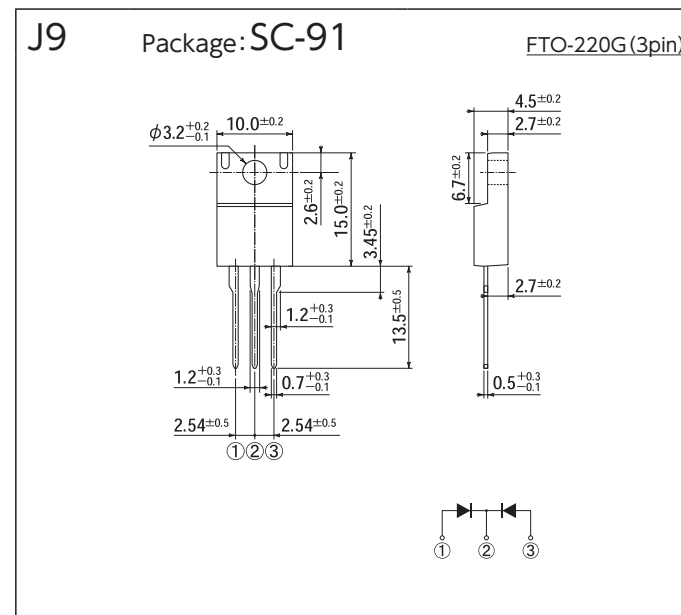
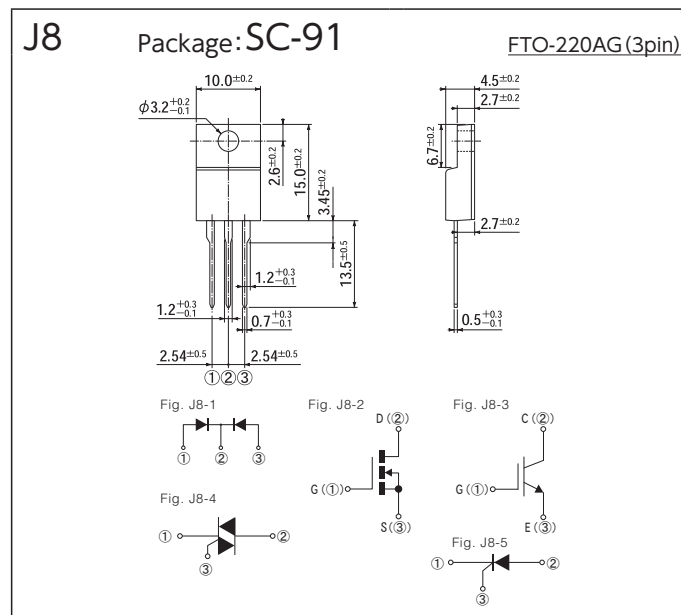
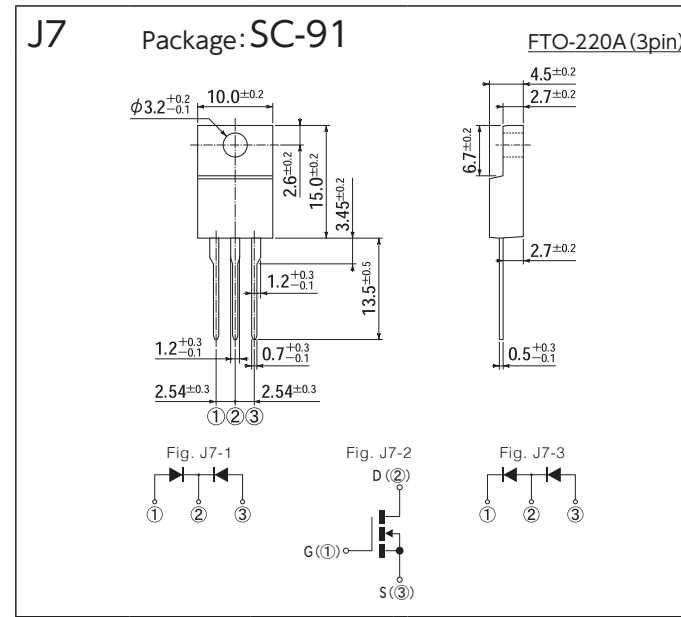
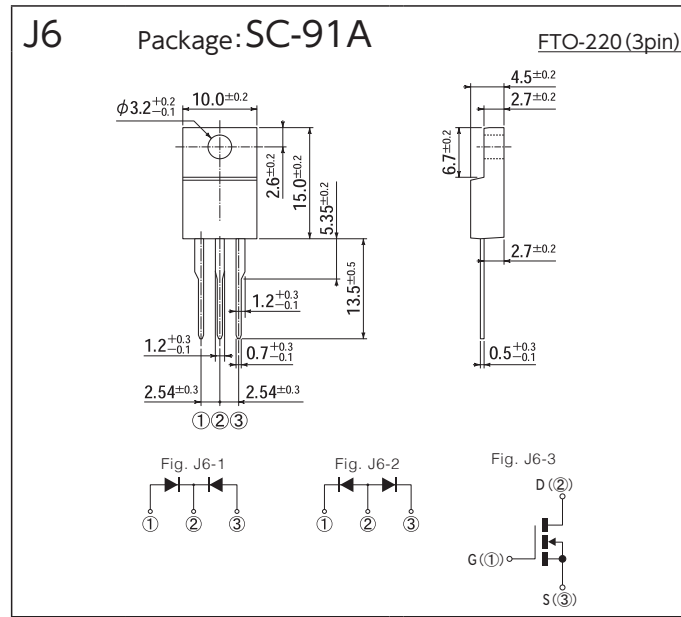

[Unit:mm]

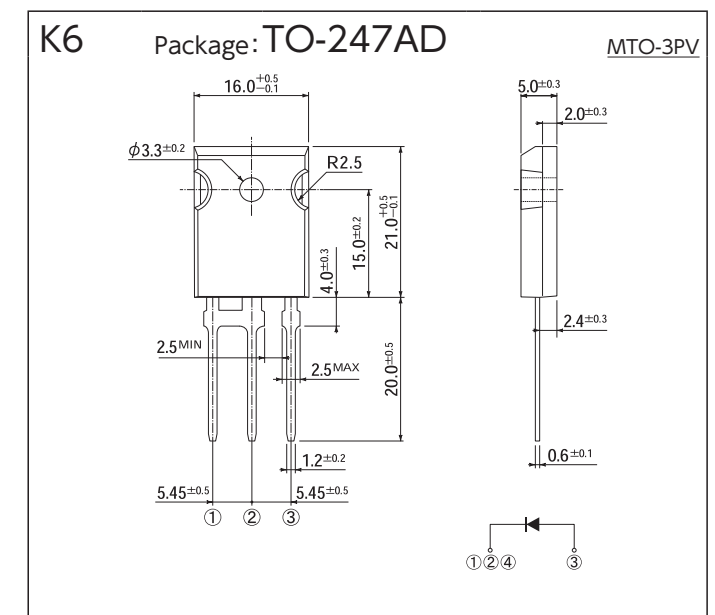
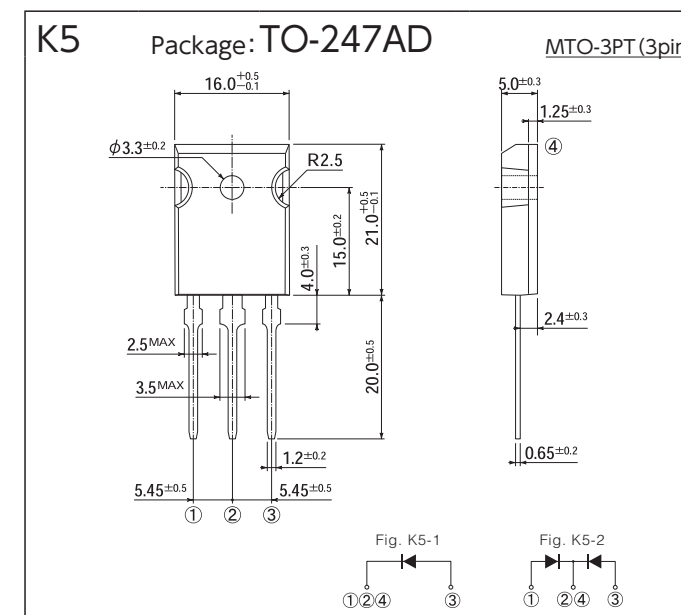
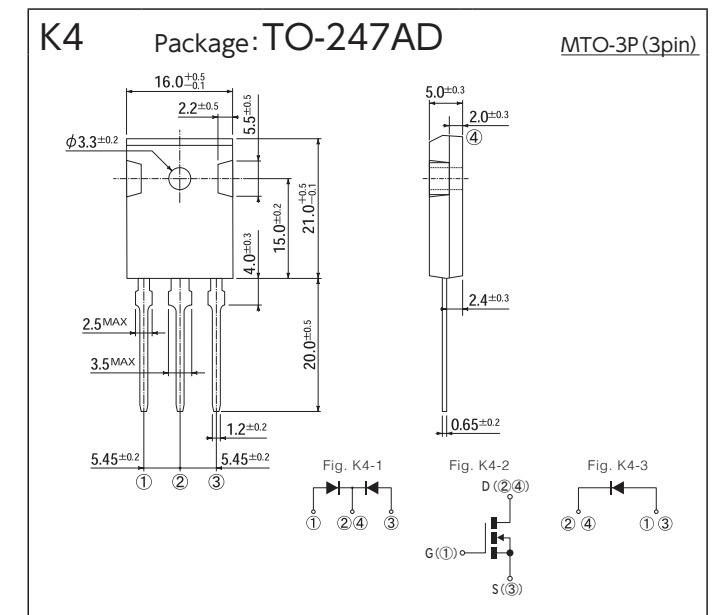
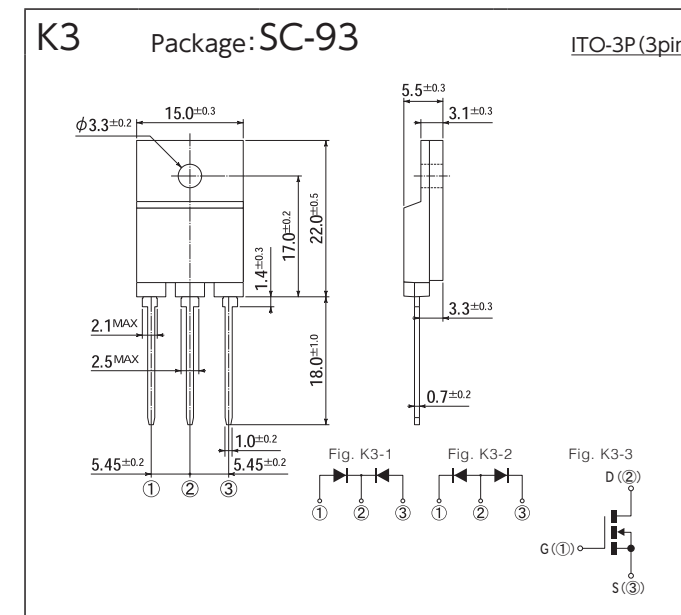
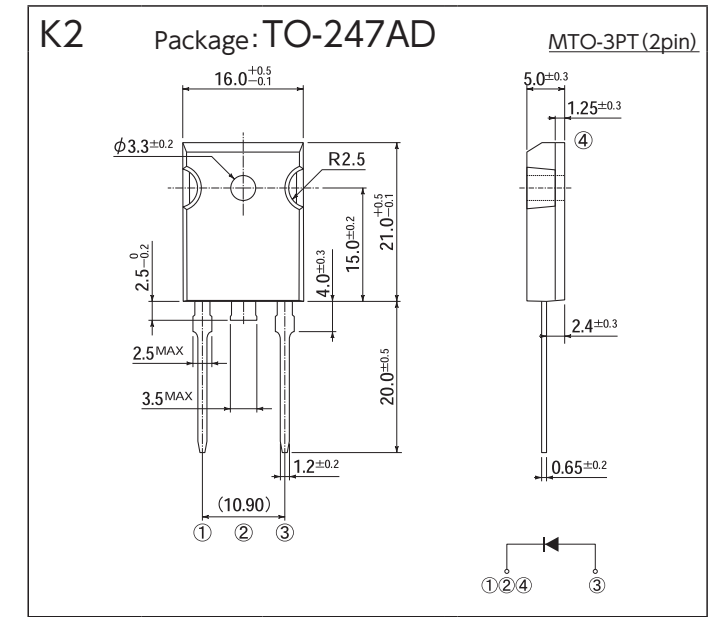
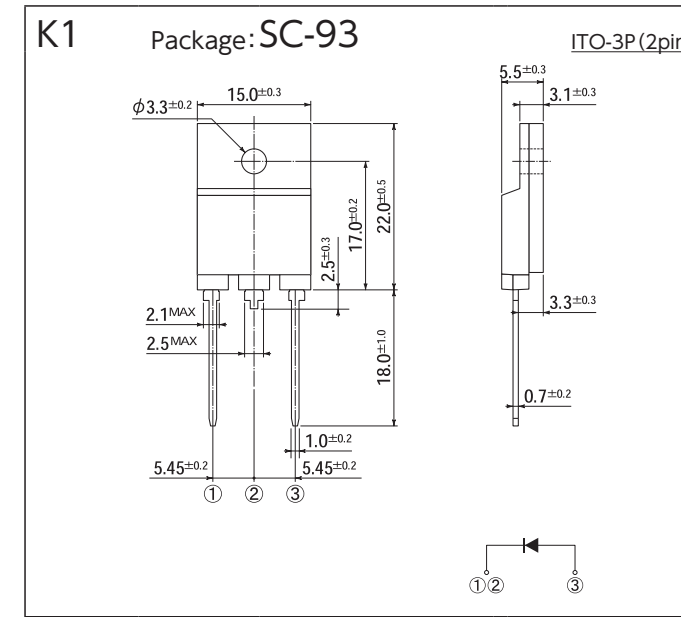

OUTLINE DIMENSIONS

[Unit:mm]

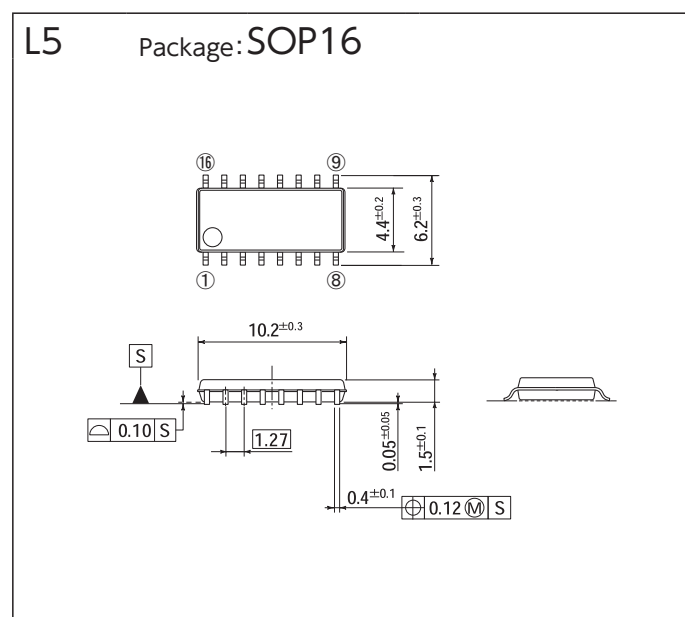
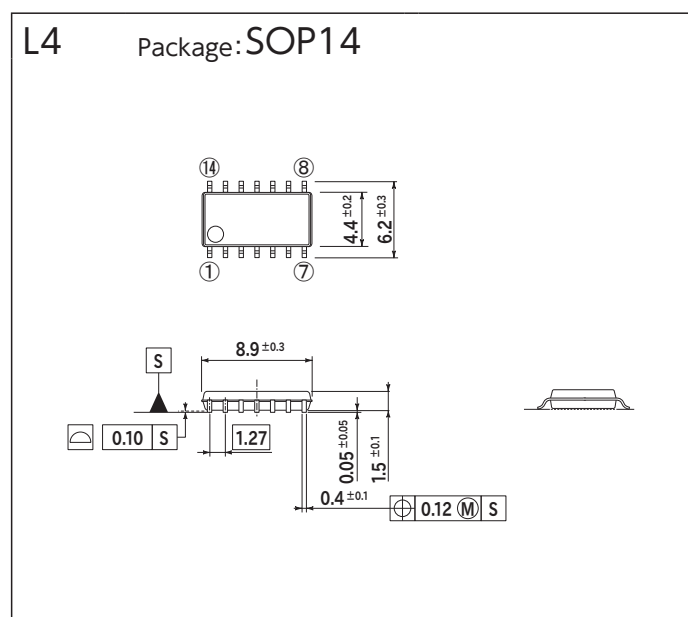
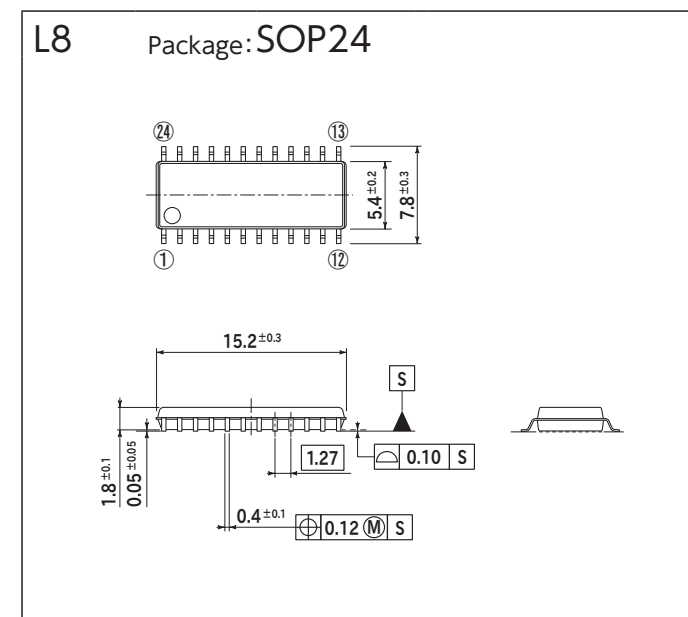
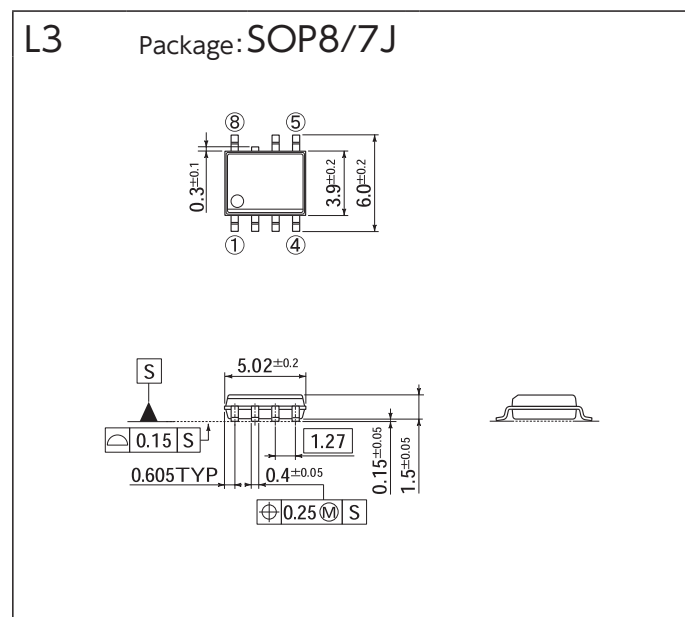
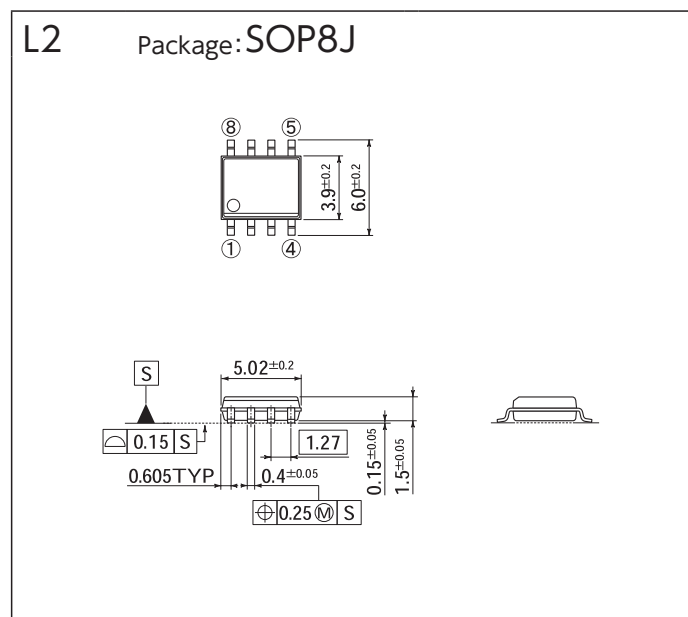
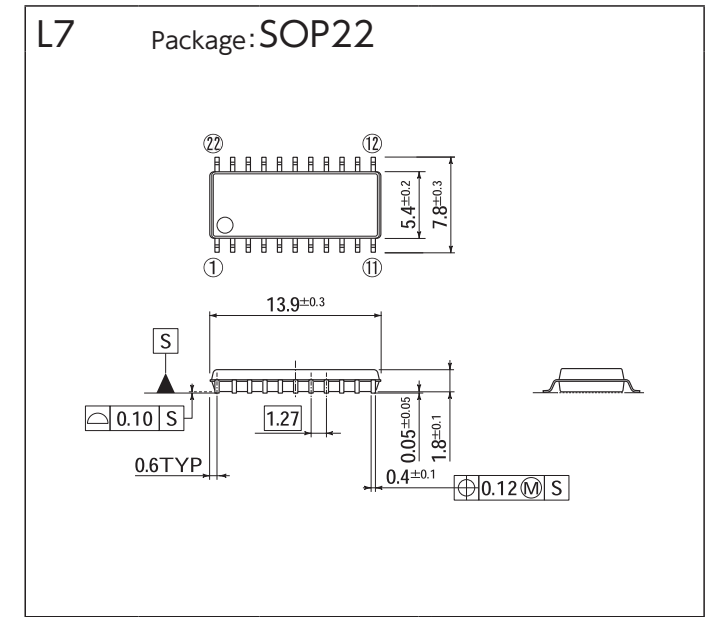
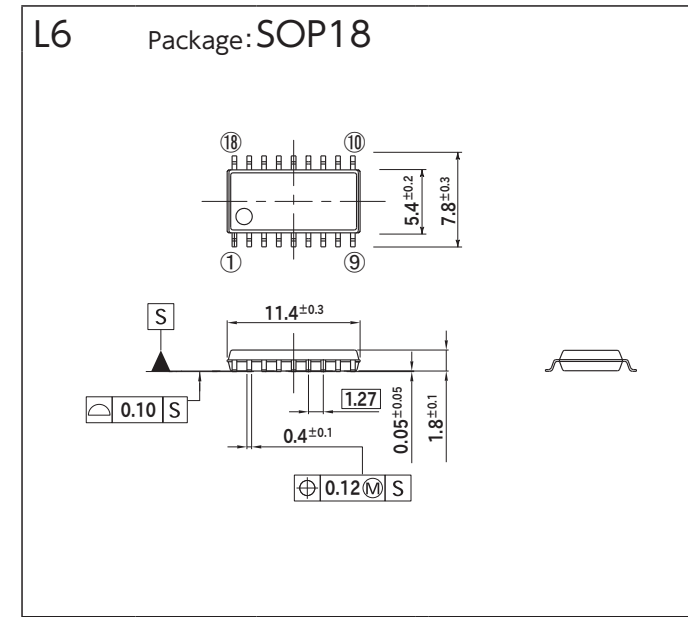
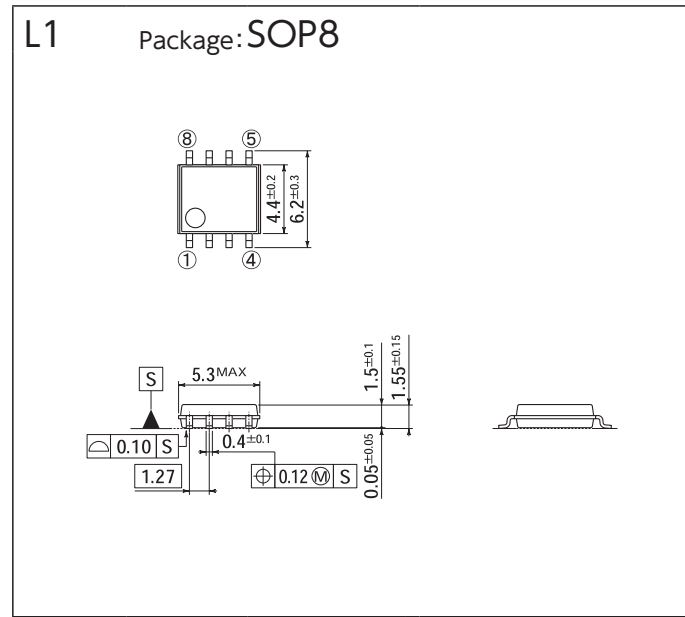
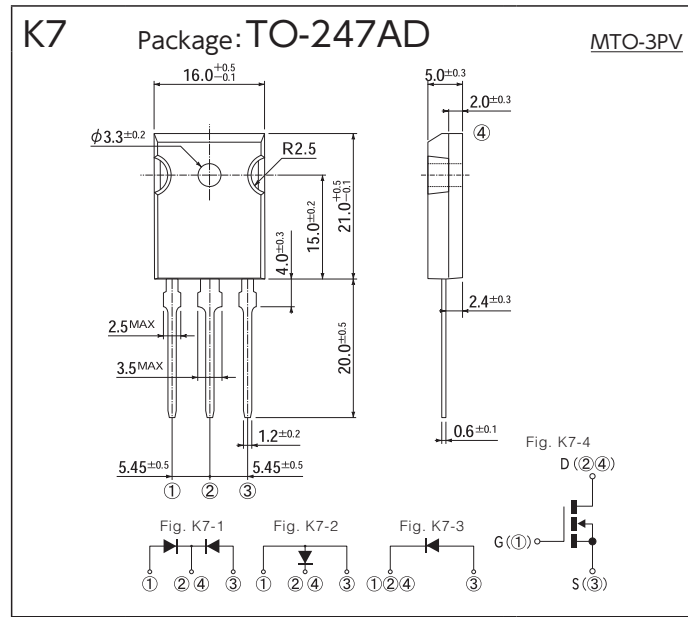

OUTLINE DIMENSIONS

PACKING SPECIFICATION

Order Quantity & Packing Dimensions List

Please make your order: 'more than Inner Box Quantities' and 'a multiple of each Packing Unit'

Package			Fig.	Spec Code	Terminal Plating	Weight (aprx.)	MSL	Remarks	Quantity	Inner Box			Standard Packing			Packing Box (mm)		
JEDEC Package Code	JEITA Code	House Name								Method	Quantity (Pcs./Box)	Pcs./Box	Weight (kg)	L	W	H		
-	-	AX057	A1	-5060	Sn	190mg	-		4,000	Tape, Ammo-Pack	52mm	4,000	32,000	7.5	330	280	270	
				-5070				Standard	3,000	Tape, Ammo-Pack	26mm	3,000	36,000	6.2	340	275	230	
				-7000					200	Bulk		200	20,000	5.9	480	355	230	
-	-	AX06	SIDAC	A2	Sn-Bi	210mg	-		4,000	Tape, Ammo-Pack	52mm	4,000	64,000	14.0	325	325	420	
				-7061					4,000	Tape&Reel, Diameter 300 φ	52mm	4,000	20,000	6.3	325	325	420	
				-7070					3,000	Tape, Ammo-Pack	26mm	3,000	72,000	15.7	325	325	420	
				-7000					200	Bulk		200	16,000	7.9	480	355	230	
-	-	AX078	TVS SIDAC	A4	Sn-Bi	390mg	-		2,000	Tape, Ammo-Pack	52mm	2,000	32,000	14.7	325	325	420	
				-7060					1,500	Tape, Ammo-Pack	26mm	1,500	18,000	7.2	325	325	260	
				-7070					200	Bulk		200	16,000	7.9	480	355	230	
			Diodes		Sn		-		2,000	Tape, Ammo-Pack	52mm	2,000	16,000	7.5	325	325	260	
				-5060					1,500	Tape, Ammo-Pack	26mm	1,500	18,000	7.2	325	325	260	
				-5070					200	Bulk		200	16,000	11.1	480	355	230	
-	-	AX10	TVS SIDAC	A5	Sn-Bi	640mg	-		1,200	Tape, Ammo-Pack	52mm	1,200	18,000	14.4	325	325	420	
				-7060					2,500	Tape&Reel, Diameter 300 φ	52mm	2,500	12,500	10.8	325	325	420	
				-7061					200	Bulk		200	16,000	11.1	480	355	230	
			Diodes		Sn		-		1,200	Tape, Ammo-Pack	52mm	1,200	9,600	7.3	325	325	260	
				-5060					2,500	Tape&Reel, Diameter 300 φ	52mm	2,500	12,500	10.8	325	325	420	
				-5061					200	Bulk		200	16,000	17.5	480	355	230	
-	-	AX14		A7	Sn	1.1g	-		1,200	Tape, Ammo-Pack	52mm	1,200	9,600	11.2	325	325	260	
				-5060					2,500	Tape&Reel, Diameter 300 φ	52mm	2,500	10,000	13.0	350	355	350	
				-5061					100	Magazine		100	15,000	2.3	545	145	110	
DO-219AB similar	SC-109	G1F	SMD	B1	Sn	12mg	1		4,000	Tape&Reel, Diameter 180 φ		24,000	48,000	1.6	180	205	210	
DO-219AA similar	-	M1F	SMD	B2	Sn	25mg	1		2,500	Tape&Reel, Diameter 180 φ		15,000	75,000	4.5	405	210	220	
				-5103					100	Magazine		100	15,000	2.3	545	145	110	
DO-214AC	-	1F	SMD	B3	Sn	60mg	1		2,000	Tape&Reel, Diameter 180 φ		8,000	40,000	4.1	340	195	205	
				-5053					7,500	Tape&Reel, Diameter 330 φ		45,000	90,000	10.8	395	245	395	
				-5073					3,000	Tape&Reel, Diameter 180 φ		12,000	24,000	1.6	180	205	210	
-	SC-110B	CE	SMD	B5	Sn	30mg	-		1,000	Tape&Reel, Diameter 180 φ		4,000	20,000	3.4	340	195	205	
DO-214AA similar	-	M2F	SMD	B6	Sn	75mg	1		4,000	Tape&Reel, Diameter 180 φ		4,000	48,000	8.6	395	245	395	
				-5063					1,000	Tape&Reel, Diameter 330 φ		4,000	48,000	8.6	395	245	395	
				-5073					60	Magazine		60	18,000	5.2	545	145	110	
-	-	2F	SMD	B9	Sn	180mg	1		750	Tape&Reel, Diameter 180 φ		3,000	15,000	4.2	340	195	205	
				-5103					3,000	Tape&Reel, Diameter 180 φ		3,000	36,000	9.2	395	245	395	
				-5063					1,000	Tape&Reel, Diameter 330 φ		1,000	20,000	3.6	340	195	205	
				-5073					1,000	Tape&Reel, Diameter 180 φ		1,000	20,000	3.6	340	195	205	
-	-	SOPA-4	SMD	C1	Sn-Bi	90mg	1		100	Magazine		100	15,000	3.2	545	145	110	
				-7102					750	Tape&Reel, Diameter 180 φ		3,000	15,000	4.0	340	195	205	
TO-269AA	-	1Z	SMD	C2	Sn-Bi	130mg	1		750	Tape&Reel, Diameter 180 φ		3,000	15,000	4.0	405	210	220	
				-7062					3,000	Tape&Reel, Diameter 330 φ		3,000	15,000	4.6	340	340	120	
				-7072					100	Magazine		100	10,000	2.1	545	145	110	
-	-		THD	C3					70	Magazine		70	5,600	4.1	545	145	100	
				-7102					1,000	Tape&Reel, Diameter 250 φ		1,000	10,000	5.5	275	285	295	
-	-	1N	SMD	C4	Sn-Bi	290mg	1		70	Magazine		70	5,600	4.1	545	145	100	
				-7062					1,000	Tape&Reel, Diameter 250 φ		1,000	10,000	5.5	275	285	295	
				-7101					70	Magazine		70	5,600	4.1	545	145	100	
-	-	1NA	SMD	C6	Sn-Bi	290mg	1		1,000	Tape&Reel, Diameter 250 φ		1,000	10,000	5.5	275	285	295	
				-7102					70	Magazine		70	5,600	4.1	545	145	100	
				-7062					1,000	Tape&Reel, Diameter 250 φ		1,000	10,000	5.5	275	285	295	
				-7101					70	Magazine		70	5,600	4.1	545	145	100	
-	-	1W	SMD	C8	Sn-Bi	500mg	1		50	Magazine		50	4,000	4.4	545	145	110	
				-7102					1,000	Tape&Reel, Diameter 330 φ		3,000	6,000	5.5	395	245	395	
				-7072					2,000	Tape&Reel, Diameter 380 φ		2,000	10,000	7.8	395	245	395	
				-7101					50	Magazine		50	4,000	4.4	545	145	110	
-	-	D3K	THD	D1	Sn-Bi	1.5g	-		500	Bulk		500	2,500	4.0	210	188	200	
-	-	2S	THD	D2	Sn-Bi	2.1g	-		100	Bulk		500	6,000	14.4	410	380	170	
-	-	3S	THD	D3	Sn-Bi	3.9-4.5g	-		50	Bulk		250	2,000	9.5	310	285	196	
-	-	5S	THD	D4	Sn-Bi	6.3-7.5g	-		50	Bulk		250	2,000	14.5	330	330	215	
-	-	JB	THD	D5	Sn-Bi	2.7g	-		250	Bulk		250	2,000	7.4	287	301	169	
-	-	JA	THD	D6	Sn-Bi	4.5g	-		250	Bulk		250	2,000	9.0	327	329	185	
-	-	TSB	THD (4pin)	D7	Sn-Bi	20g	-		100	Bulk		100	400	9.8	351	269	164	
			THD (5pin)	D8														
-	-	JC	THD (4pin)	D7	Sn-Bi	20g	-		40	Tray		40	200	5.6	503	356	135	
			THD (5pin)	D8														
-	-	JF	THD	D9	Sn-Bi	25g	-		40	Tray		40	200	5.6	503	356	135	
-	-	JH	THD	D10	Sn-Bi	31g	-		40	Tray		40	200	5.6	503	356	135	
-	-	MCP	SMD	E1	Ni	1.9g	1		300	Tape&Reel, Diameter 255 φ		300	1,500	5.0	280	275	190	
				-4062					600	Tape&Reel, Diameter 330 φ		600	1,800	5.5	335	345	110	
				-4072														

Exterior packaging is an example. Depending on the quantity ordered, the number of incoming, outline and weight may change.

Please make your order: 'more than Inner Box Quantities' and 'a multiple of each Packing Unit'

Package			Fig.	Spec Code	Terminal Plating	Weight (aprx.)	MSL	Remarks	Quantity	Inner Box			Standard Packing			Packing Box (mm)		
JEDEC Package Code	JEITA Code	House Name								Method	Quantity (Pcs./Box)	Pcs./Box	Weight (kg)	L	W	H		
-	-	D30VC	THD	E2	-4000	Ag	12g	-	100	Tray		100	500	7.0	375	285	160	
-	-	S2VB	THD	E3	-5000	Sn-Ag-Cu	3.0g	-	100	Tray		100	1,000	3.6	265	255	170	
-	-	S4VB	THD	E4	-5000	Sn-Ag-Cu	5.2g	-	100	Tray		100	1,000	5.9	315	285	220	
-	-	S5VB	THD	E5	-5000	Sn-Ag-Cu	9.1g	-	100	Tray		100	1,000	10.4	415	285	300	
-	-	S10VB	THD	E6	-5000	Sn-Ag-Cu	8.0g	-	100	Tray		100	1,000	9.3	375	285	270	
-	-	S15VB	THD	E7	-4000	Ag	16g	-	100	Tray		100	500	9.0	415	285	180	
-	-	S25VB	THD	E8	-4000	Ag	21g	-	60	Bulk		60	300	7.0	335	205	165	
-	-	S50VB	THD	E9	-4000	Ag	28g	-	50	Tray		50	200	6.2	335	205	165	
-	-	S3WB	THD	E10	-5000	Sn-Ag-Cu	5.1g	-	100	Tray		100	1,000	6.1				

NOTES

How to Order

1. Indication of Spec. Code when ordering

Please specify the Spec. Code when ordering semiconductors.
For the Spec. Code, Please refer to as follows and "PACKING SPECIFICATION".

Example Ordering THD type of S1ZB60
S1ZB60-7101

2. Spec Code

The code specifies each packing form, lead forming and terminal plate material.
Please refer to "PACKING SPECIFICATION".

Example 5 0 0 0

- 5 : Terminal forming
 - 0 : Straight terminal
 - 1 to 9 : Each number shows type of form
- 0 : Packing form
 - 0 : Standard
 - In case of surface mounting devices
 - 5, 6 : Small reel
 - 7 : Large reel
 - In case of axial device
 - 6 : Lead length 52mm (T52)
 - 7 : Lead length 26mm (T26)
- 0 : Minimum packing unit
 - 0 : Bulk, tray or taping
 - 1 : Magazine
 - 5 : Tray
 - 6 : Packed (FTO-220 Package)
- 0 : Terminal plate material
 - 3 : Ni/Pd/Au, Sn-Ag
 - 4 : Ni, Ag
 - 5 : Sn-Ag-Cu, Sn, Ag, Sn-Cu
 - 6 : Sn
 - 7 : Sn-Bi

Outline of Packing Form

1. Minimum packing unit

- Bulk : The form in which parts are inserted into plastic bags or cardboard boxes.
- Tray : The form in which parts are inserted in to containers made of resin.



- Magazine : The form in which parts are inserted into resin cartridges designated for automatic inserters.



- Taping
 - Reel (Surface mounting devices)



- Box (Axial devices)



2. Packing Box Dimensions

See the following pages for the dimensions of each cardboard box.

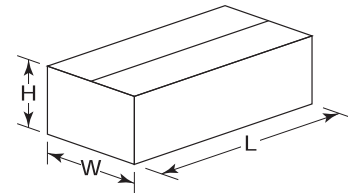

About AEC-Q101 & Automotive Grade

1. AEC-Q101

These products are AEC-Q101 compliant.

2. Automotive Grade

These products are produced on a designated production line qualified for internal automotive standards.

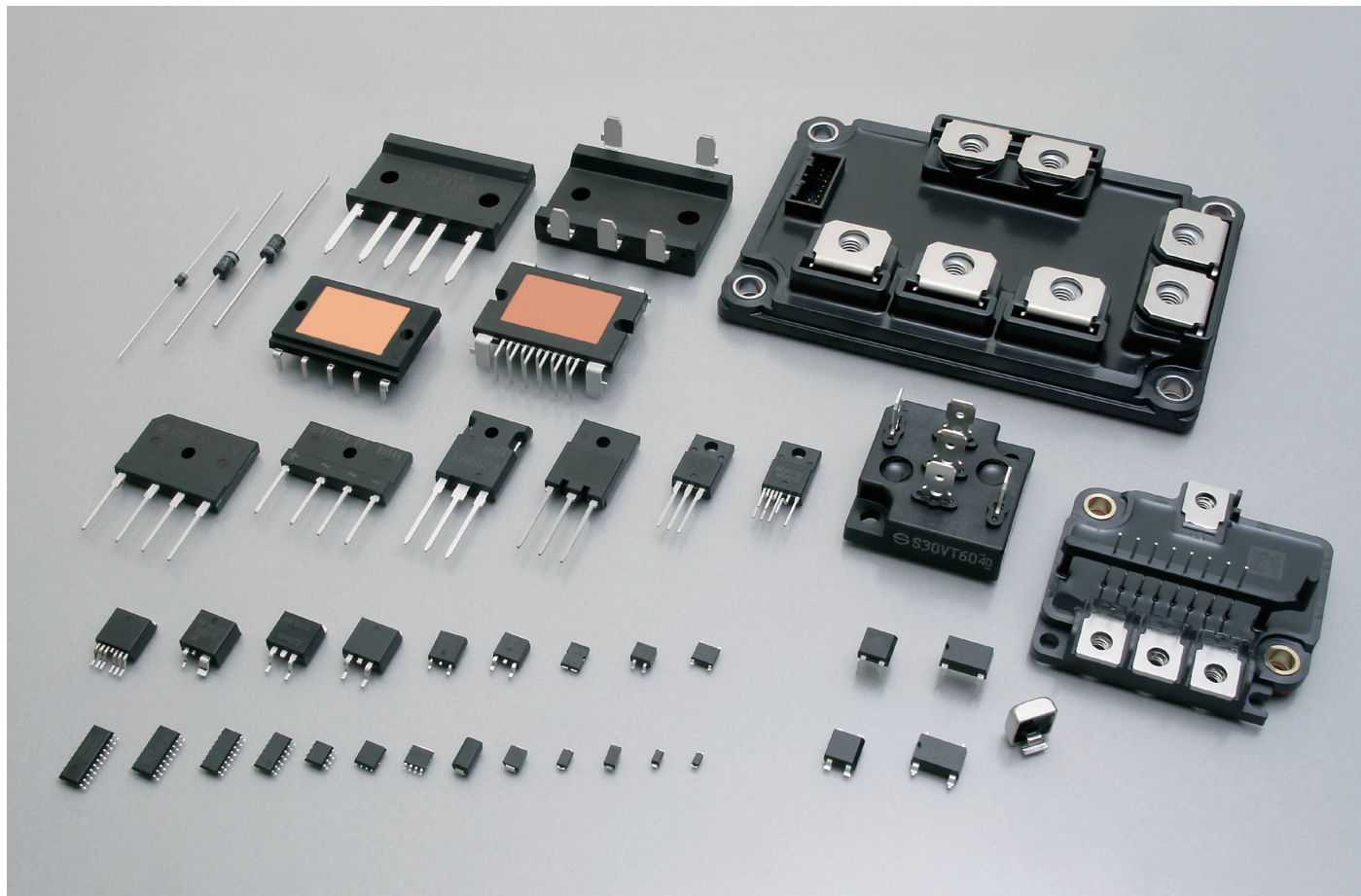

Notes

- ⚠ If you wish to use any such product, please be sure to refer to the specifications issued by Shindengen.
- ⚠ All products described or contained herein are designed with a quality level intended for use in standard applications requiring an ordinary level of reliability. If these products are to be used in equipment or devices for special or specific applications requiring an extremely high grade of quality or reliability in which failures or malfunctions of products may directly affect human life or health, a local Shindengen office must be contacted in advance to confirm that the intended use of the product is appropriate. Shindengen products are grouped into the following three applications according to the quality grade.
 - Standard applications
Computers, office automation and other office equipment, communication terminals, test and measurement equipment, audio/visual equipment, amusement equipment, consumer electronics, machine tools, personal electronic equipment, industrial equipment, etc.
 - Special applications
Transportation equipment (vehicles, ships, etc.), trunk-line communication equipment, traffic signal control systems, anti-disaster/crime systems, safety equipment, medical equipment, etc.
 - Specific applications
Nuclear reactor control systems, aircraft, aerospace equipment, submarine repeaters, life support equipment and systems, etc.
- ⚠ Although Shindengen continuously endeavors to enhance the quality and reliability of its products, customers are advised to consider and take safety measures in their design, such as redundancy, fire containment and anti-failure, so that personal injury, fires, or societal damages can be prevented.
- ⚠ Please note that all information described or contained herein is subject to change without notice due to product upgrades and other reasons. When buying Shindengen products, please contact the Company's offices or distributors to obtain the latest information.
- ⚠ Shindengen shall not bear any responsibility with regards to damages or infringement of any third-party patent rights and other intellectual property rights incurred due to the use of information on this website.
- ⚠ The information and materials on this website neither warrant the use of Shindengen's or any third party's patent rights and other intellectual property rights, nor grant license to such rights.
- ⚠ In the event that any product described or contained herein falls under the category of strategic products controlled under the Foreign Exchange and Foreign Trade Control Law of Japan, exporting of such products shall require an export license from the Japanese government in accordance with the above law.
- ⚠ No reprinting or reproduction of the materials on this website, either in whole or in part, is permitted without proper authorization from Shindengen.

SALES OFFICES

U.S.A.

Shindengen America, Inc. www.shindengen.com/

2333 Waukegan Road Suite250, Bannockburn, IL.60015. U.S.A
Phone:+1-847-444-1363 FAX:+1-847-444-0654

Europe

Shindengen UK Ltd. www.shindengen.co.eu/

Head Office

Unit 1, 1 Tapper Walk, King's Cross, London, N1C 4AQ U.K.
Phone:+44-20-3829-6980 FAX:+44-20-3725-6855

German Branch

Prinzenallee 1, 40549 Düsseldorf, Germany
Phone:+49-211-5206-590 FAX:+49-211-4986-499

Asia

Shindengen Singapore PTE Ltd.

750d, Chai Chee Road, #05-01,
Viva Business Park, Singapore 469004
Phone:+65-6445-0082 FAX:+65-6445-6089

Shindengen (H.K.) Co., Ltd.

Head Office

Suite 2006B, 20/F., Exchange Tower, 33 Wang Chiu Road,
Kowloon Bay, HK
Phone:+852-2317-1884 FAX:+852-2314-8561

Taiwan Representative Office

20FL, No.85, Sec.1, Jhongsiao E. Road, Taipei, 10049,
Taiwan, R.O.C.
Phone:+886-2-2321-3990 FAX:+886-2-2358-3991

Shindengen (SHANGHAI) Electric Co., Ltd.

Room1506, Sheng GaoInt'l Building, 137 Xian Xia Road,
Chang Ning, Shanghai, China
Phone:+86-21-6270-8000 FAX:+86-21-6270-0419

Shindengen Electric Mfg. Co., Ltd.

Seoul Office

B701-4. 230, Simin-daero, Dongan-gu, Anyang-si,
Gyeonggi-do, 14067 Korea
Phone:+82-31-385-1431 FAX:+82-31-385-1430

Japan

Shindengen Electric MFG. Co., Ltd. www.shindengen.co.jp/

Head Office

New-Ohtemachi Bldg., 2-2-1, Ohtemachi, Chiyoda-ku,
Tokyo 100-0004, Japan
Phone:+81-3-3279-4431 FAX:+81-3-3279-6478

Osaka Branch Office

Minami Senba Heart Bldg., 2-3-2, Minami-Senba,
Chuo-ku, Osaka City, Osaka 542-0081, Japan
Phone:+81-6-6264-7770 FAX:+81-6-6260-1222

Nagoya Branch Office

Nagoya Daiichi Bldg., 1-19-24, Nishiki, Naka-ku,
Nagoya City, Aichi 460-0003, Japan
Phone:+81-52-221-1361 FAX:+81-52-201-4780

Hamamatsu branch

Hamamatsu Daiichi Seimei Nittsu Bldg., 110-5, Itaya-cho,
Naka-ku, Hamamatsu City, Shizuoka 430-0928, Japan
Phone:+81-53-450-3800 FAX:+81-53-450-3801

Utsunomiya Sales Office

Flora Bldg., 1-9-15 Higashi Syukugou Utsunomiya City,
Tochigi 321-0953, Japan
Phone:+81-28-637-3615 FAX:+81-28-637-3115

- All specifications are subject to change without notice.
- Please consult us for the latest specifications before you order.
- Please use this products after reading manual well.

• Printed January 2020

This catalog includes the products which might be subject to the foreign exchange and foreign trade laws.

Package Outline

* = Similar Package

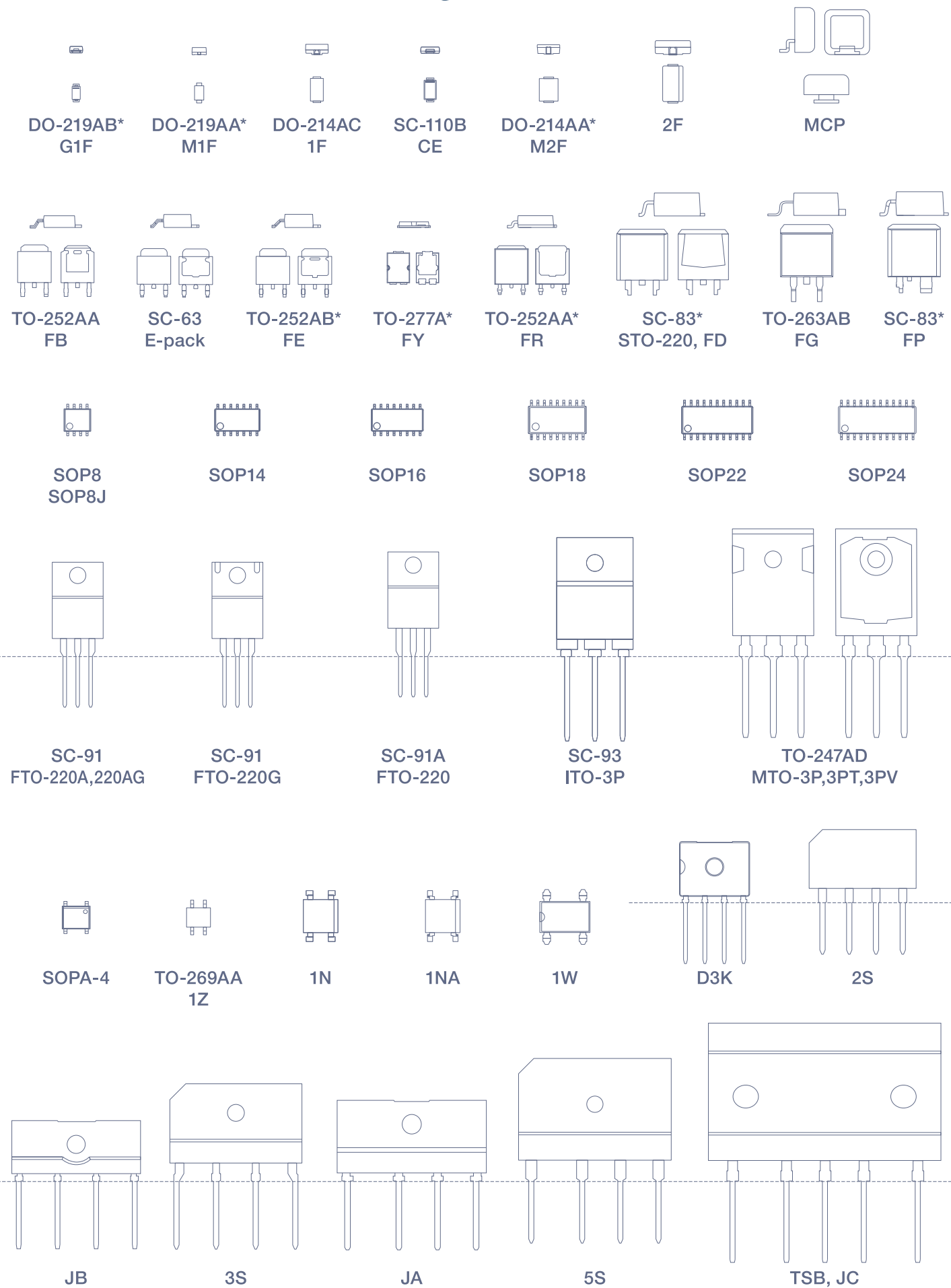

Semiconductor Product Catalog

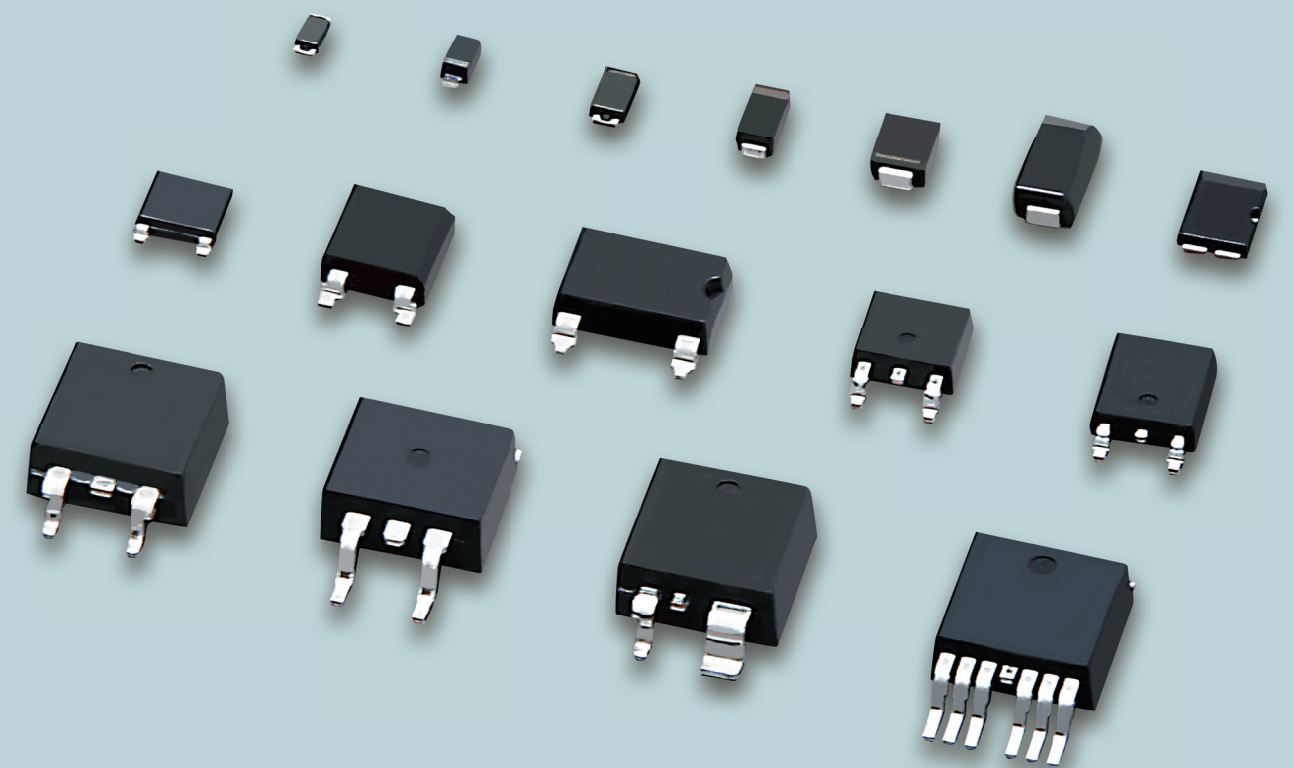

Shindengen Electric Manufacturing Co., Ltd.
www.shindengen.co.jp



CAT.NO.F072-13

1901-3500(1)

ShinDengen
 New power. Your power.

X-ON Electronics

Largest Supplier of Electrical and Electronic Components

Click to view similar products for [Zener Diodes](#) category:

Click to view products by [Shindengen](#) manufacturer:

Other Similar products are found below :

[RKZ13B2KG#P1](#) [DL5234B](#) [1N4682](#) [1N4691](#) [1N4693](#) [1N4732A](#) [1N4733A-TR](#) [1N4736A](#) [1N4750A](#) [1N4759ARL](#) [1N5241B](#) [1N5365B](#)
[1N5369B](#) [1N747A](#) [1N959B](#) [1N964B](#) [1N966B](#) [1N968B](#) [1N972B](#) [NTE149A](#) [NTE5116A](#) [NTE5121A](#) [NTE5147A](#) [NTE5152A](#) [NTE5155A](#)
[NTE5164A](#) [JANS1N4974US](#) [1N4692](#) [1N4700](#) [1N4702](#) [1N4704](#) [1N4711](#) [1N4714](#) [1N4737A](#) [1N4745ARL](#) [1N4752A](#) [1N4752ARL](#)
[1N4760ARL](#) [1N5221B](#) [1N5236B](#) [1N5241BTR](#) [1N5242BTR](#) [1N5350B](#) [1N5352B](#) [1N961BRR1](#) [1N964BRL](#) [RKZ5.1BKU#P6](#)
[3SMAJ5950B-TP](#) [3SMBJ5925B-TP](#) [TDZTR24](#)