

# S12H RELAY

SHORI

## ◆ Features

- Heavy duty 40A general purpose power relays.
- Optional for open frame, dust cover, sealed type and with and without quick terminal on top ,etc.
- High insulation type Dielectric strength type available.
- Ideal for HVAC, UPS & power supply, home appliances.



## ◆ Coil Data [at 20°C]

Rated voltage ( V )	Coil Resistance ±10% (Ω)	Rated Current ±10% (mA)	Pick up Voltage (Max)	Drop out Voltage (Min)	Max continuous Voltage	Power consumption At rated Voltage
5	27	186	75% of rated voltage	10% of rated voltage	130% Max of Rated voltage	Approx.0.93W
6	40	155				
9	97	93				
12	155	77				
15	256	59				
18	380	47				
24	660	36				
48	2560	18				
110	13450	8				

## ◆ Contact Rating

Load type	1A	1B	1C	
			NO	NC
Resistive load	40A 277VAC	30A 277VAC	40A 277VAC	30A 277VAC
	30A 28VDC	20A 28VDC	30A 28VDC	20A 28VDC

## ◆ Type List

Terminal style	Contact form	Designation(provided with)	
		Open type	Sealed type washable
PCB terminal	1A (SPNO)	S12H-PA-12	S12H-PAS-12
	1B (SPNC)	S12H-PB-12	S12H-PBS-12
	1C(SPDT)	S12H-PC-12	S12H-PCS-12

# S12H RELAY

## SHORI

### ◆ Ordering information

S12H - P C S - 12  
 1 2 3 4 5

1. S12H -- Basic series designation
2. P -- PCB terminal
3. A -- Single pole normally open  
 B -- Single pole normally closed  
 C -- Single pole double throw
4. S -- Sealed type washable  
 Blank -- Open type
5. 12 -- Coil Voltage (5V~110V)

### ◆ Specification

Contact material	Ag Alloy	
Contact resistance	50 mΩ Max	
Operate time	15 ms Max	
Release time	10 ms Max	
Insulation resistance	100 MΩ Min. (DC 500V)	
Dielectric strength	Between open contact : AC 1500V ,50/60Hz 1 min.	
	Between contact and coil : AC 1500V, 50/60Hz 1 min.	
Vibration resistance	Operating extremes	10~50Hz, amplitude 1.5 mm
	Damage limits	10~50Hz, amplitude 1.5 mm
Shock resistance	Operating extremes	10G
	Damage limits	100G
Life expectancy	Mechanical	10,000,000 operations (frequency 18,000 operations/hr)
	Electrical	100,000 operations (frequency 1,200 operations/hr)
Operating ambient temperature	-30~+85°C (no freezing)	
Weight	Approx. 25g	

### ◆ Safety Approval

Certified	UL/CUL	TUV
File No.	E188091	

# S12H RELAY

SHORI

## ◆ Safety Approval Rating (UL/CUL)

PAS	PBS	PCS	
		NO	NC
40A 277VAC	30A 277VAC	40A 277VAC	30A 277VAC
30A 28VDC	20A 28VDC	30A 28VDC	20A 28VDC
2HP 277VAC	2HP 240VAC	2HP 277VAC	2HP 240VAC
1HP 120VAC	1HP 120VAC	1HP 120VAC	1HP 120VAC
1800W/120VAC Tungsten	240W/120VAC Tungsten	1800W/120VAC Tungsten	240W/120VAC Tungsten

## ◆ Outline dimensions

### ➤ S12H Open type

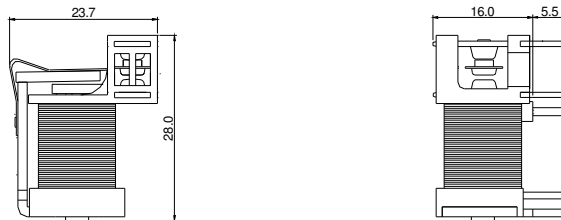

### ➤ S12H (P) type

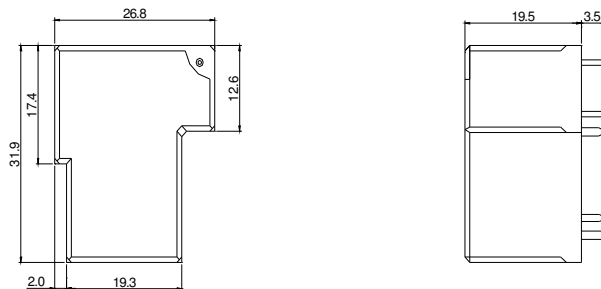

### ➤ S12H (F) type

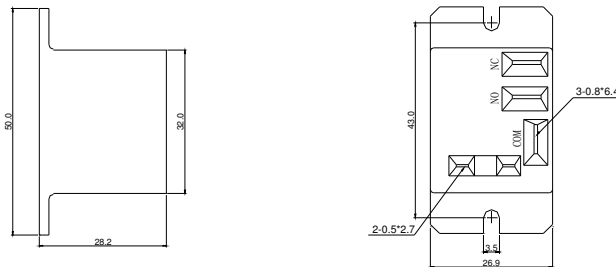

### ➤ S12H (Q) type

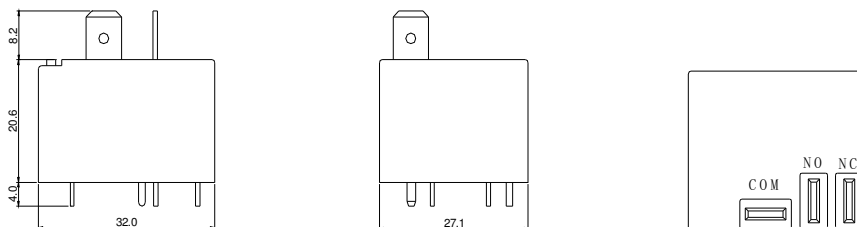

# S12H RELAY

## SHORI

### ◆ Wiring Diagram

S12H(P) BOTTOM VIEW

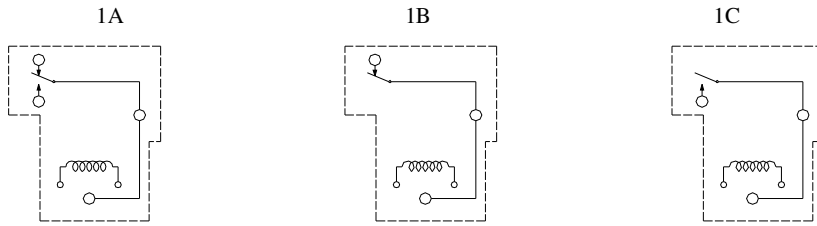

### ◆ PC BOARD LAYOUT

BOTTOM VIEW

S12H(P) type

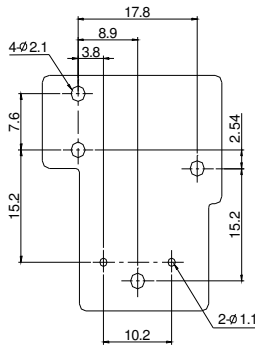

S12H(Q) type

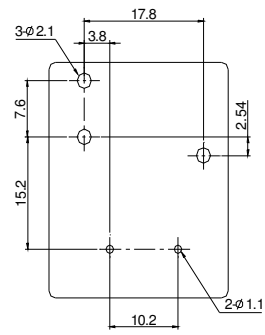

### ◆ Engineering Data

Coil temperature rise

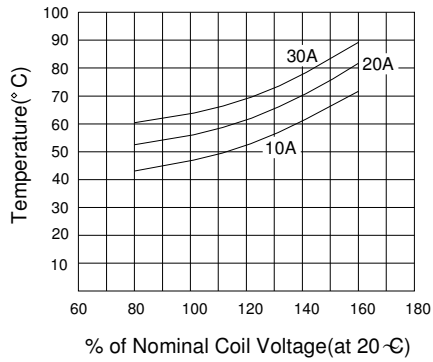

Coil temperature rise

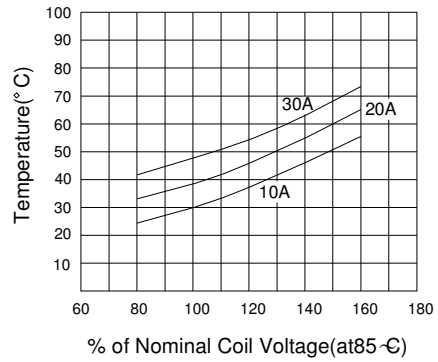

Life expectancy

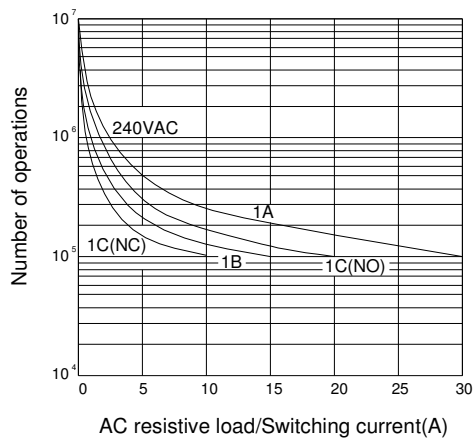

Operate time/Release time

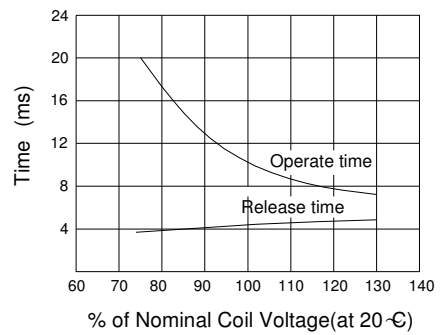

## X-ON Electronics

Largest Supplier of Electrical and Electronic Components

*Click to view similar products for [General Purpose Relays](#) category:*

*Click to view products by [Shori](#) manufacturer:*

Other Similar products are found below :

[APF30318](#) [JVN1AF-4.5V-F](#) [PCN-105D3MHZ](#) [5JO-10000S-SIL](#) [5JO-1000CD-SIL](#) [5JO-400CD-SIL](#) [LY2S-AC220/240](#) [LYQ20DC12](#)  
[6031007G](#) [6131406HQ](#) [6-1393099-3](#) [6-1393099-8](#) [6-1393122-4](#) [6-1393123-2](#) [6-1393767-1](#) [6-1393843-7](#) [6-1415012-1](#) [6-1419102-2](#) [6-](#)  
[1423698-4](#) [6-1608051-6](#) [6-1608067-0](#) [6-1616170-6](#) [6-1616248-2](#) [6-1616282-3](#) [6-1616348-2](#) [6-1616350-1](#) [6-1616350-8](#) [6-1616358-7](#) [6-](#)  
[1616359-9](#) [6-1616360-9](#) [6-1616931-6](#) [6-1617039-1](#) [6-1617052-1](#) [6-1617090-2](#) [6-1617090-5](#) [6-1617347-5](#) [6-1617353-3](#) [6-1617801-8](#) [6-](#)  
[1617802-2](#) [6-1618107-9](#) [6-1618248-4](#) [M83536/1-027M](#) [CX-4014](#) [MAHC-5494](#) [MAVCD-5419-6](#) [703XCX-120A](#) [7-1393100-5](#) [7-1393111-7](#)  
[7-1393144-5](#) [7-1393767-8](#)