

D		E		F	
版次 (Ed)	变更摘要 (Change The Content)	日期 (Date)	序号 (NO.)	品名 (Name)	材质 (Material)
0	新产品发行 (New Product Launch)	2017/09/06	①	2.00 F型卧式2代WTB胶芯 2.00 Pitch R/A Wire To Board Housing (H=5.2)	LCP UL94V-0 本色 Natural
			②	2.00 F型卧式2代WTB端子 2.00 Pitch R/A Wire To Board Terminal (H=5.2)	铜合金/表面镀锡 Copper Alloy/ Tin Plating
			③	2.00 F型卧式WTB焊片 2.00 Pitch R/A Wire To Board Fitting Nail (H=5.6)	铜合金/表面镀锡 Copper Alloy/ Tin Plating

N-0.5±0.03 (SQ) 2.00±0.15 (PITCH)

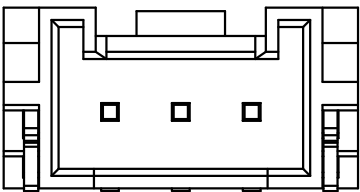
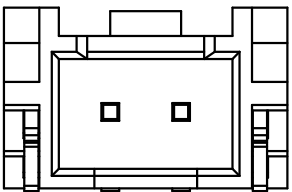
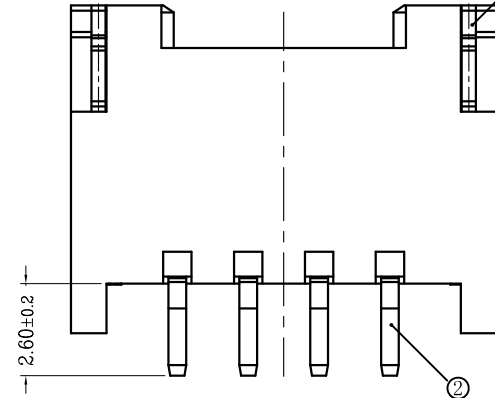
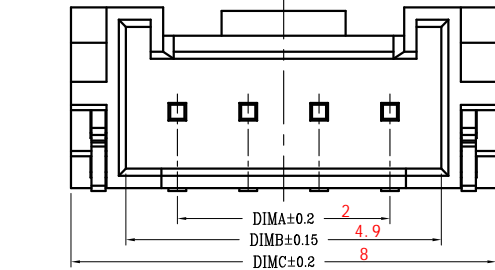
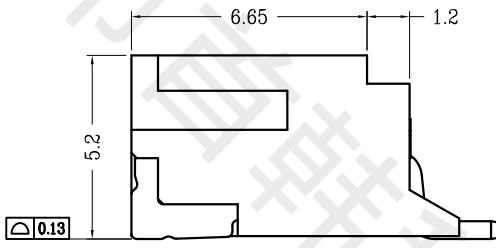
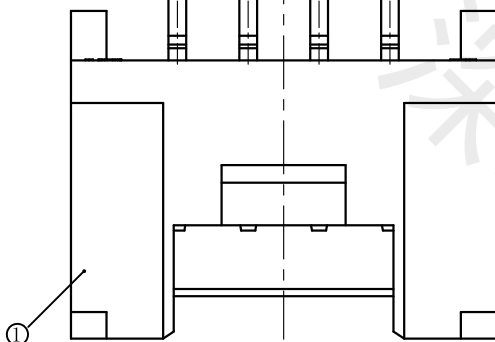
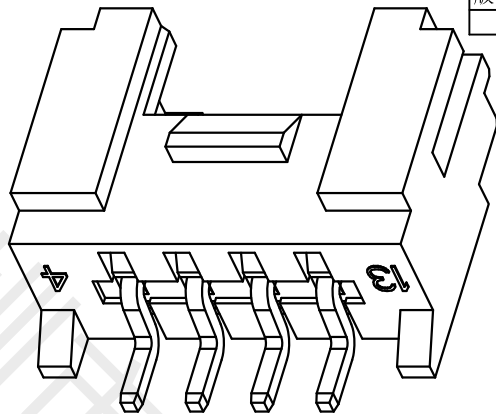

2 PIN 结构样式  
(Structural style)

3 PIN 结构样式  
(Structural style)

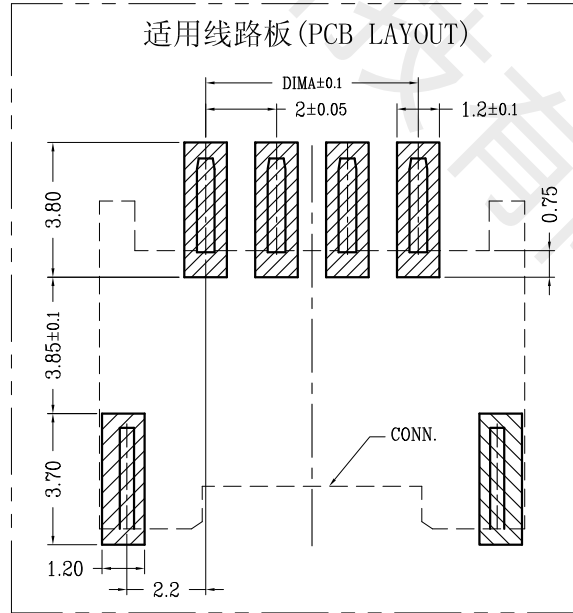

技术指标 (Technical Index):

- 塑件表面应光洁、无毛边、无明显收缩、缺陷、裂纹等现象。  
(The surface of the plastic parts should be smooth, no rough edges, no obvious shrinkage, defects, cracks and other phenomena)
- 温度范围 (Temperature range): -40° C ~ +85° C.
- 额定电压 (Rated voltage): 100V, AC.
- 接触电阻 (Contact resistance):  
≤55mΩ (Initial) per contact, ≤25mΩ Change allowed.
- 绝缘电阻 (Insulation resistance): ≥1000MΩ.
- 产品料号 (Product material No.):

WT200FW-\*\*\* \*-2\*

20	胶芯有LOGO:WD (Housing with LOGO:WD)
2W	胶芯无LOGO (Housing without LOGO)

NO OF CKT (产品PIN数)      Packing (包装方式)

Plating (电镀方式):  
1: 端子全金 (Terminal G/F OVER ALL)  
4: 端子全亮锡 (Terminal all bright tin)

Packing (包装方式):  
T: TUBE管装  
R: TAPE & REEL卷装

CKT	DIM A	DIM B	DIM C
2	2.00	4.90	8.00
3	4.00	6.90	10.00
4	6.00	8.90	12.00
5	8.00	10.90	14.00
6	10.00	12.90	16.00
7	12.00	14.90	18.00
8	14.00	16.90	20.00
9	16.00	18.90	22.00
10	18.00	20.90	24.00
11	20.00	22.90	26.00
12	22.00	24.90	28.00
13	24.00	26.90	30.00
14	26.00	28.90	32.00
15	28.00	30.90	34.00
16	30.00	32.90	36.00
17	32.00	34.90	38.00
18	34.00	36.90	40.00
19	36.00	38.90	42.00
20	38.00	40.90	44.00



一般公差 (TOLERANCE)  
X ±0.50    .XX ±0.10  
X ±0.20    .XXX ±0.05  
ANGLES    ±1°

首韩 SHOUHAN 深圳市首韩科技有限公司

品名 (TITLE)	针座		制图 (DR)	李春风
料号 (DWG.NO)	2.0-2P WTDK		校对 (CHKD)	钟华华
比例 (SCALE)	1:1	单位 (UNITS)	mm	审核 (APPD)
张数 (SHEET)	1 OF 1	尺寸 (SIZE)	A4	罗孝金
REV	A			



深圳市首韩科技有限公司

SHENZHEN SHOUHAN TECHNOLOGY CO., LTD

Tel: 0755-27597601 Fax: 0755-27597491

# 承 认 书

## SPECIFICATION FOR APPROVAL

客 户 Customer:

\_\_\_\_\_

产品名称 Project:

针座

\_\_\_\_\_

规格型号 Part No:

2.0-2P WTDK

\_\_\_\_\_

### 贵公司承认印 Approval signatures

料 号/Part No.	签 章/Signatures

日期 Date:

拟制/Drawn	李春风	
审核/Check	钟华华	
批准/Approved	罗孝金	

## 1、SCOPE: (适用范围)

1.1 This specification covers production and inspection of Connector.

本规范内容适用于本公司普通系列型条形连接器（针座）产品的生产与检验。

## 2、USE CONDITION: (使用条件)

### 2.1 Ambient temperature Range:-25℃~+105℃

环境温度：-40℃~+85℃

### 2.2 Applicable Wire Sizes:AWG#28~#32

适用线规：AWG#28~#32

### 2.3 Applicable PC board thickness:0.6~1.2mm

适用PC板厚度：0.6~1.2 mm

## 3、Appearance and Dimension: (外观及尺寸)

### 3.1 Appearance:Product surface without defect、dirt、crack、and mechanical damang, Contact without rust,plating not oxidized and not peeled.

产品表面不应有对制品有害的缺陷、污垢、裂痕及机械损伤；接触件无锈蚀、镀层氧化、脱落等现象。

### 3.2 Dimension:According to drawings

外形尺寸：依照附图

### 3.3 Exchangable:Exchangable with same specification products.

互换性：相同规格应能互换

## 4、Material: (以图纸要求为准)

### 材 料

P/N 零件名称	Type 类 型	Material 材 料	Finish 表面处理	Explain 说 明
Terminal 端子	Contact 插 簧	Phosphor bronze 锡青磷铜 厚 0.15mm	Tin Plating:3~4 μ m 镀锡: 3~4 μ m	RoHS Compliant
Housing 孔 座	Plastic 塑 壳	Nylon66 UL94V-0	Color:White 颜色: 白色	
Opening Wafer 开口针座	Contact 插 针	Phosphor bronze 锡青磷铜 厚 0.30mm	Tin Plating:3~4 μ m 镀锡: 3~4 μ m	
	Plastic 塑 壳	Nylon46 UL94V-0	Color: Beige 颜色: 米色	
Lips Wafer 闭口针座	Contact 插 针	Phosphor bronze 锡青磷铜 厚 0.30mm	Gold Plating:3~4 μ " m 镀金: 3~4 μ " m	
	Plastic 塑 壳	PBT UL94V-0	Color: White 颜色: 白色	
Tiepian Wafer 卧贴针座 立贴针座	Contact 插 针	Phosphor bronze 锡青磷铜 厚 0.30mm	Tin Plating:3~4 μ m 镀锡: 3~4 μ m	
	Solder tabs 焊护耳	Phosphor bronze 锡青磷铜 厚 0.25mm	Tin Plating:3~4 μ m 镀锡: 3~4 μ m	
	Plastic 塑 壳	Nylon46 UL94V-0	Color: Beige 颜色: 米色	

## 5、Electrical Performance:

电气性能

N0. 序号	Ltem 项目	Requirement 技术要求
5.1	Voltage Rated 额定电压	100V AC DC
5.2	Current Rated 额定电流	2A AC DC
5.3	Contact Resistance 接触电阻	$\leq 55 \text{ m}\Omega$
5.4	Insulation Resistance 绝缘电阻	$\geq 1000 \text{ M}\Omega$
5.5	Dielectric Strength 耐压	$\geq 200\text{V AC/minute}$

## 6、Mechanical Performance:

机械性能

N0. 序号	Ltem 项目	Requirement 技术要求
6.1	Male contact Retention force PIN 针固定力	$\geq 15\text{N}$ per pin
6.2	Female contact Retention force 端子固定力	$\geq 15\text{N}$ per pin
6.3	Plug-in force 插入力	$\leq 3\text{N}$ per pin
6.4	Plug-out force 拔出力	$\geq 0.5\text{N}$ per pin

## 7、Endurance Characteristics:

环境性能

N0. 序号	Ltem 项目	Requirement 技术要求
7.1	Soldering rest 可焊性	Time: $2.5 \pm 0.5\text{S}$ 时间: $2.5 \pm 0.5\text{S}$  Temperature: $260 \pm 5^\circ\text{C}$ 温度: $260 \pm 5^\circ\text{C}$  Area of Soldering: $\geq 95\%$ 焊锡面积: $\geq 95\%$

7.2	Resistance to soldering Heat 耐焊接热	<p>Time:5±1S 时间:5±1S</p> <p>Temperature:260±5℃ 温度: 260±5℃</p> <p>Appearance:NO Damage 外观: 无损坏</p>
7.3	Heat test 耐热性	<p>Time:96h 时间: 96 小时</p> <p>Temperature:+85±3℃ 温度: +85±3℃</p> <p>Appearance:NO Damage 外观: 无损坏</p> <p>Contact resistance: ≤20 mΩ 接触电阻: ≤20 mΩ</p>
7.4	Cold test 耐冷性	<p>Time:48h 时间: 48 小时</p> <p>Temperature:-25±3℃ 温度: -25±3℃</p> <p>Appearance:NO Damage 外观: 无损坏</p> <p>Contact resistance: ≤20 mΩ 接触电阻: ≤20 mΩ</p>
7.5	Temperature Cycling 温度循环	<p>Low temperature:-25±3℃ 低温: -25±3℃</p> <p>High temperature:85±3℃ 高温: 85±3℃</p> <p>For 5 cycles. test after keeping in Normal Condition for 30 min. 5 次循环后, 放置在正常环境中 30 分钟, 在进行测试</p> <p>Appearance: NO Damage 外观: 无损坏</p> <p>Contact resistance: ≤20 mΩ 接触电阻: ≤20 mΩ</p>

7.6	Invariab lenes humidity 恒定湿热	<p>Temperature: <math>60 \pm 2^{\circ}\text{C}</math> 温度: <math>60 \pm 2^{\circ}\text{C}</math></p> <p>Relative humidity: 90%-96% RH 相对湿度: 90%-96% RH</p> <p>Tim: 96h 时间: 96 小时</p> <p>Appearance: NO Damage 外观: 无损坏</p> <p>Contact resistance: <math>\leq 20 \text{ m}\Omega</math> 接触电阻: <math>\leq 20 \text{ m}\Omega</math></p> <p>Insulation Resistance: <math>\geq 100 \text{ M}\Omega</math> 绝缘电阻: <math>\geq 100 \text{ M}\Omega</math></p>
7.7	Salt Spray 盐雾试验	<p>Salt concentration: <math>5 \pm 1\%</math> 浓度: <math>5 \pm 1\%</math></p> <p>Temperature: <math>35 \pm 2^{\circ}\text{C}</math> 温度: <math>35 \pm 2^{\circ}\text{C}</math></p> <p>Tim: <math>16 \pm 2\text{h}</math> 时间: <math>16 \pm 2</math> 小时</p> <p>After salt is removed by running wafer and A drop is removed ,it is measured.</p> <p>把试验样品从试验箱顶悬挂下来,采用浓度 (<math>5 \pm 1</math>) %的氯化钠溶液,连续雾化 16 小时,试验后用流动的蒸馏水轻轻洗去表面沉积物,在常温常驻湿条件下恢复 1-2 小时,外观无损伤</p> <p>Appearance: NO Damage 外观: 无损坏</p> <p>Contact resistance: <math>\leq 20 \text{ m}\Omega</math> 接触电阻: <math>\leq 20 \text{ m}\Omega</math></p>

## 8、Packaging Transportation Storage

包装、运输、贮存

### 8.1 Packaging

包装

- (1) **The packing of plastic inner is the plastic bag,the packing of inner terminal is panel mounting attach material packing, marked with product name, specification model, quantity, date in produced.**

塑件内包装为塑料袋，端子内包装为盘装带料包装，装（贴）入合格证，注明产品名称、规格型号、数量生产日期

- (2) **Exterior package is carton, facing the packing list, the packing list marked with product name, specification model, quantity, date of dispatch.**

外包装为纸箱，贴装箱单、装箱单上注明产品名称、规格型号、数量、出货日期

- (3) **The product in the box must not rock.**

产品在箱内不晃动

### 8.2 Transportation

运输

**Allow for any way transportation, can't get wet and mechanical in jury.**

允许用任何方式运输，勿淋湿及机械性损伤

### 8.3 Storage

贮存

**The connector of packing finished should be in the ambient temperature between-10℃ to+40℃, Relative humidity≤80%. To store in storehouse does not have acidic, alkaline air and other corrosive gas in the ambient air.**

包装完毕的连接器应在环境温度为-10℃~+40℃，相对湿度≤80%，周围空气中没有酸性，碱性及其它腐蚀性气体的库房中贮存

## X-ON Electronics

Largest Supplier of Electrical and Electronic Components

*Click to view similar products for [Headers & Wire Housings](#) category:*

*Click to view products by [SHOU](#) manufacturer:*

Other Similar products are found below :

[57102-F02-18ULF](#) [58102-G61-06LF](#) [582553-1](#) [009176003701906](#) [01.001.5753.1](#) [0050291907](#) [02.125.8002.8](#) [609-3404](#) [61062-3](#)  
[CSU011177004](#) [622-0430](#) [622-3653LF](#) [63453-116](#) [636-1030](#) [636-1427](#) [636-3427](#) [636-4007](#) [641938-9](#) [65495-038](#) [65692-001LF](#) [65781-018](#)  
[65781-047](#) [65817-010LF](#) [65817-015LF](#) [66207-023LF](#) [67095-007LF](#) [67601157](#) [68631-112](#) [699319-000](#) [M90C108951C](#) [70.362.1628.0](#) [70-](#)  
[4210](#) [70-4226B](#) [70-4853B](#) [707-5028](#) [71.350.2428.0](#) [71961-016LF](#) [733-134](#) [733-162](#) [754199-000](#) [760-3052](#) [80.063.4001.1](#) [800-90-001-10-](#)  
[001000](#) [801-43-002-10-013000](#) [801-43-006-10-002000](#) [803-41-018-10-001000](#) [803-43-024-10-001000](#) [803-93-012-10-001000](#) [8-1437020-4](#)  
[819-22-004-30-001101](#)