



深圳市首韩科技有限公司

SHENZHEN SHOUHAN TECHNOLOGY CO., LTD

Tel: 0755-27597601 Fax: 0755-27597491

承 认 书

SPECIFICATION FOR APPROVAL

客 户 Customer:

产品名称 Project:

贴片电感

规格型号 Part No:

CY75-470UH

贵公司承认印 Approval signatures

料 号/Part No.	签 章/Signatures

日期 Date:

拟制/Drawn	李春风	
审核/Check	钟华华	
批准/Approved	罗孝金	

1.Features

- ①. High performance (Isat) realize by metal dust core.
- ②. Low profile: Thickness max.2.0~5.0mm.
- ③. Low loss and low resistance.
- ④. Capable of corresponding high frequency 1MHz~5MHz.
- ⑤. Ultra low buzz noise, due to composite construction.
- ⑥. The products contain no lead and also support lead-free soldering.

2.Applications area

Ideally used in NB/Desktop/server/Graphic card, LCD TV/Projector, etc as DC-DC Converter.

3. Externl Dimensions (unit: mm)

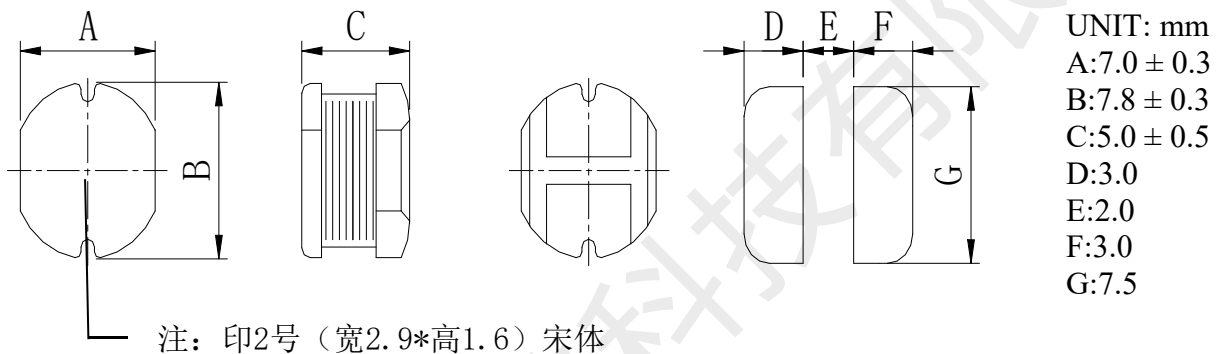

4. Product Code

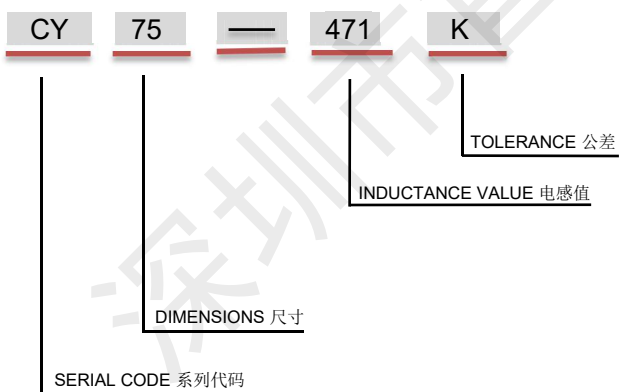

Code 代码	Tolerance 公差
J	±5%
K	±10%
L	±15%
M	±20%
P	±25%
N	±30%

- 电感值 Inductance Value
 (1R0:1.0uH; 100: 10uH; 101:100uH)



5. Electrical Characteristics

CY75 type

PART No.	NOMINAL INDUCTANCE (μ H)	Test Freq. (kHz/v)	DCR (Ω)MAX	IDC (A)MAX
CY75-1R0N	1.0	100/0.25	13.00m	5.20
CY75-2R7M	2.7	100/0.25	16.90m	4.60
CY75-3R3M	3.3	100/0.25	19.50m	4.00
CY75-3R9M	3.9	100/0.25	23.40m	4.00
CY75-4R7M	4.7	100/0.25	26.00m	3.80
CY75-5R6M	5.6	100/0.25	27.30m	3.10
CY75-6R8M	6.8	100/0.25	32.50m	2.80
CY75-8R2M	8.2	100/0.25	39.00m	2.52
CY75-100K	10	100/0.25	41.60m	2.31
CY75-120K	12	100/0.25	49.40m	2.00
CY75-150K	15	100/0.25	71.50m	1.81
CY75-180K	18	100/0.25	84.50m	1.59
CY75-220K	22	100/0.25	91.00m	1.50
CY75-270K	27	100/0.25	106.60m	1.28
CY75-330K	33	100/0.25	119.60m	1.20
CY75-390K	39	100/0.25	149.50m	1.08
CY75-470K	47	100/0.25	175.50m	1.05
CY75-560K	56	100/0.25	208.00m	930m
CY75-680K	68	100/0.25	234.00m	830m
CY75-820K	82	100/0.25	273.00m	780m
CY75-101K	100	100/0.25	325.00m	730m
CY75-121K	120	100/0.25	390.00m	650m
CY75-151K	150	100/0.25	520.00m	580m
CY75-181K	180	100/0.25	598.00m	510m
CY75-221K	220	100/0.25	793.00m	480m
CY75-271K	270	100/0.25	884.00m	400m
CY75-331K	330	100/0.25	1.13	390m
CY75-391K	390	100/0.25	1.30	350m
CY75-471K	470	100/0.25	1.68	330m
CY75-561K	560	100/0.25	1.90	300m
CY75-681K	680	100/0.25	2.47	270m
CY75-821K	820	100/0.25	2.86	250m

• Notes

1. All test data is referenced to 25 °C ambient

2. Operating temperature range - 55 °C to + 125 °C
3. Irms (A):DC current (A) that will cause an approximate ΔT of 40 °C(reference ambient temperature is 25 °C)
4. Isat(A):DC current (A) that will cause L0 to drop approximately 30 %
5. The part temperature (ambient + temp rise) should not exceed 125 °C under worst case operating conditions.
Circuit design, component placement, PWB trace size and thickness, airflow and other cooling provisions all affect the part temperature. Part temperature should be verified in the end application.
6. Absolute maximum voltage 30VDC

6. Minimum Packaging and storage

• 包装 Packing

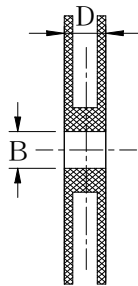
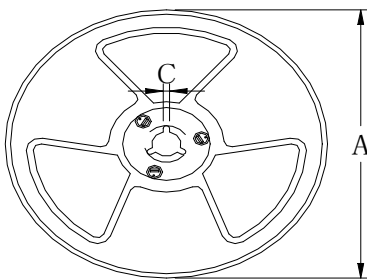

规格 尺寸	13"	7"
A	$\Phi 330 \pm 2.0$	$\Phi 178 \pm 2.0$
B	$\Phi 90 \pm 2.0$	
C	2.3	
D	21.5	1000/盘

• Tape Carrier Packaging:

Type	Standard Quantity (pcs/reel)	Type	Standard Quantity (pcs/reel)
CY43SX	2000	CY75SX	1000
CY53SX	2000	CY77SX	600
CY54SX	1500	CY105SX	1000
CY73SX	1000	CY106SX	800

• Tearing Off Force

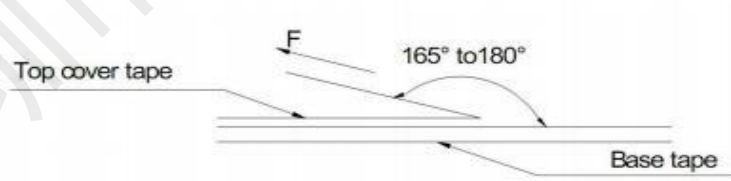

The force for tearing off cover tape is 15 to 60 grams in the arrow direction under the following conditions

Room Temp. ()°C	Room Humidity (%)	Room atm (hPa)	Tearing Speed mm/min
5~35	45~85	860~1060	300

• Application Notice

Storage Conditions To maintain the solderability of terminal electrodes:

1. Temperature and humidity conditions: Less than 30°C and 70% RH.
2. Recommended products should be used within 6 months form the time of delivery.
3. The packaging material should be kept where no chlorine or sulfur exists in the air.

Transportation

1. Products should be handled with care to avoid damage or contamination from perspiration and skin oils .
2. The use of tweezers or vacuum pick up is strongly recommended for individual components. Bulk handling should ensure that abrasion and mechanical shock are minimized.

X-ON Electronics

Largest Supplier of Electrical and Electronic Components

Click to view similar products for [Fixed Inductors](#) category:

Click to view products by [SHOU](#) manufacturer:

Other Similar products are found below :

[CR32NP-100KC](#) [CR54NP-470LC](#) [70F224AI](#) [MGDQ4-00004-P](#) [MHQ1005P10NJ](#) [MHQ1005P1N0S](#) [MHQ1005P2N4S](#) [MHQ1005P3N6S](#)
[MHQ1005P5N1S](#) [MHQ1005P8N2J](#) [PE-53601NL](#) [PE-53602NL](#) [PG0936.113NLT](#) [9220-20](#) [9310-16](#) [PM06-2N7](#) [PM06-39NJ](#) [A01TK](#)
[1206CS-471XJ](#) [HC2-R47-R](#) [HC8-1R2-R](#) [HCF1305-3R3-R](#) [1206CS-151XG](#) [RCH664NP-140L](#) [RCH664NP-4R7M](#) [RCP1317NP-391L](#)
[RCR110DNP-331L](#) [DH2280-4R7M](#) [DS1608C-106](#) [B10TJ](#) [B82498B3101J000](#) [ELJ-RE27NJF2](#) [1812CS-153XJ](#) [1812CS-183XJ](#) [1812CS-](#)
[223XJ](#) [1812LS-104XJ](#) [1812LS-105XJ](#) [1812LS-124XJ](#) [1812LS-154XJ](#) [1812LS-223XJ](#) [1812LS-224XJ](#) [1812LS-563XJ](#) [1812LS-683XJ](#)
[1812LS-824XJ](#) [NIN-FB101JTR110F](#) [NIN-FB471JTR62F](#) [NIN-FC1R5JTR220F](#) [NIN-HCR15JTRF](#) [NIN-HCR33JTRF](#) [NIN-HDR22JTRF](#)