



深圳市首韩科技有限公司

SHENZHEN SHOUHAN TECHNOLOGY CO., LTD

Tel: 0755-27597601 Fax: 0755-27597491

承 认 书

SPECIFICATION FOR APPROVAL

客 户 Customer:

产品名称 Project:

电感

规格型号 Part No:

CYH74-100UH

贵公司承认印 Approval signatures

料 号/Part No.	签 章/Signatures

日期 Date:

拟制/Drawn	李春风	
审核/Check	钟华华	
批准/Approved	罗孝金	

1.Features

- ①. High performance (Isat) realize by metal dust core.
- ②. Low profile: Thickness max.2.0~5.0mm.
- ③. Low loss and low resistance.
- ④. Capable of corresponding high frequency 1MHz~5MHz.
- ⑤. Ultra low buzz noise, due to composite construction.
- ⑥. The products contain no lead and also support lead-free soldering.

2.Applications area

Ideally used in NB/Desktop/server/Graphic card, LCD TV/Projector, etc as DC-DC Converter.

3. Externl Dimensions (unit: mm)

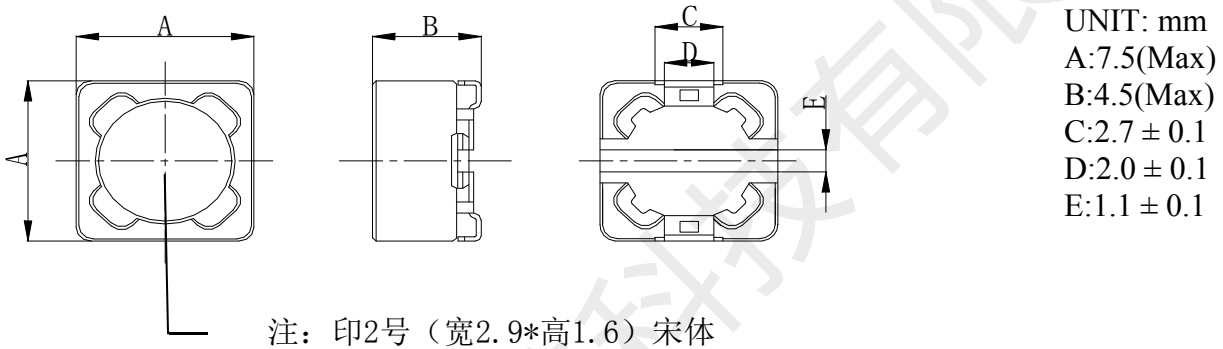

4. Product Code

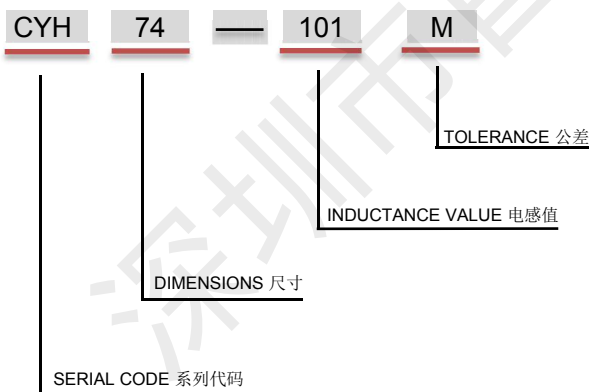

Code 代码	Tolerance 公差
J	±5%
K	±10%
L	±15%
M	±20%
P	±25%
N	±30%

- 电感值Inductance Value
(1R0:1.0uH; 100: 10uH; 101:100uH)

5. Electrical Characteristics

CYH74 type

PART No.	NOMINAL INDUCTANCE (μ H)	Test Freq. (kHz/v)	DCR (Ω)MAX	IDC (A)MAX
CYH74-1R0N	1.0	100/0.25	36.4m	5.00
CYH74-1R5N	1.5	100/0.25	20.8m	4.60
CYH74-2R2N	2.2	100/0.25	24.7m	4.40
CYH74-3R3N	3.3	100/0.25	29.2m	3.90
CYH74-3R9N	3.9	100/0.25	32.5m	3.30
CYH74-4R7N	4.7	100/0.25	39m	3.05
CYH74-6R8N	6.8	100/0.25	45.5m	2.90
CYH74-100M	10	100/0.25	65m	2.00
CYH74-120M	12	100/0.25	70.2m	1.90
CYH74-150M	15	100/0.25	78m	1.70
CYH74-180M	18	100/0.25	110.5m	1.55
CYH74-220M	22	100/0.25	126.1m	1.40
CYH74-270M	27	100/0.25	140.4m	1.30
CYH74-330M	33	100/0.25	176.8m	1.10
CYH74-390M	39	100/0.25	226.2m	1.03
CYH74-470M	47	100/0.25	260m	900m
CYH74-560M	56	100/0.25	286m	820m
CYH74-680M	68	100/0.25	338m	774m
CYH74-820M	82	100/0.25	364m	700m
CYH74-101M	100	100/0.25	403m	680m
CYH74-121M	120	100/0.25	546m	650m
CYH74-151M	150	100/0.25	689m	590m
CYH74-181M	180	100/0.25	767m	570m
CYH74-221M	220	100/0.25	1.24	470m
CYH74-271M	270	100/0.25	1.30	450m
CYH74-331M	330	100/0.25	1.52	425m
CYH74-391M	390	100/0.25	1.77	375m
CYH74-471M	470	100/0.25	2.60	330m
CYH74-561M	560	100/0.25	2.80	290m
CYH74-681M	680	100/0.25	3.05	260m
CYH74-102M	1000	100/0.25	6.00	180m

• **Notes**

1. All test data is referenced to 25 °C ambient
2. Operating temperature range - 55 °C to + 125 °C
3. Irms (A):DC current (A) that will cause an approximate ΔT of 40 °C(reference ambient temperature is 25 °C)
4. Isat(A):DC current (A) that will cause L0 to drop approximately 30 %
5. The part temperature (ambient + temp rise) should not exceed 125 °C under worst case operating conditions.
Circuit design, component placement, PWB trace size and thickness, airflow and other cooling provisions all affect the part temperature. Part temperature should be verified in the end application.
6. Absolute maximum voltage 30VDC

6. Minimum Packaging and storage

• **包装 Packing**

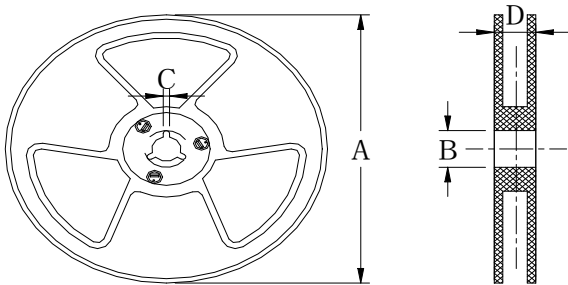

规格 尺寸	13"	7"
A	$\Phi 330 \pm 2.0$	$\Phi 178 \pm 2.0$
B	$\Phi 90 \pm 2.0$	
C	2.3	
D	21.5	1000/盘

• **Tape Carrier Packaging:**

Type	Standard Quantity (pcs/reel)	Type	Standard Quantity (pcs/reel)
CYH73	1000	CYH127	500
CYH74	1000	CYH129	500
CYH125	500		

• **Tearing Off Force**

The force for tearing off cover tape is 15 to 60 grams in the arrow direction under the following conditions

Room Temp. ()°C	Room Humidity (%)	Room atm (hPa)	Tearing Speed mm/min
5~35	45~85	860~1060	300

• **Application Notice**

Storage Conditions To maintain the solderability of terminal electrodes:

1. Temperature and humidity conditions: Less than 30°C and 70% RH.
2. Recommended products should be used within 6 months form the time of delivery.
3. The packaging material should be kept where no chlorine or sulfur exists in the air.

Transportation

1. Products should be handled with care to avoid damage or contamination from perspiration and skin oils.
2. The use of tweezers or vacuum pick up is strongly recommended for individual components. Bulk handling should ensure that abrasion and mechanical shock are minimized.

X-ON Electronics

Largest Supplier of Electrical and Electronic Components

Click to view similar products for [Fixed Inductors](#) category:

Click to view products by [SHOU](#) manufacturer:

Other Similar products are found below :

[CR32NP-100KC](#) [CR54NP-470LC](#) [70F224AI](#) [MGDQ4-00004-P](#) [MHQ1005P10NJ](#) [MHQ1005P1N0S](#) [MHQ1005P2N4S](#) [MHQ1005P3N6S](#)
[MHQ1005P5N1S](#) [MHQ1005P8N2J](#) [PE-53601NL](#) [PE-53602NL](#) [PG0936.113NLT](#) [9220-20](#) [9310-16](#) [PM06-2N7](#) [PM06-39NJ](#) [A01TK](#)
[1206CS-471XJ](#) [HC2-R47-R](#) [HC8-1R2-R](#) [HCF1305-3R3-R](#) [1206CS-151XG](#) [RCH664NP-140L](#) [RCH664NP-4R7M](#) [RCP1317NP-391L](#)
[RCR110DNP-331L](#) [DH2280-4R7M](#) [DS1608C-106](#) [B10TJ](#) [B82498B3101J000](#) [ELJ-RE27NJF2](#) [1812CS-153XJ](#) [1812CS-183XJ](#) [1812CS-](#)
[223XJ](#) [1812LS-104XJ](#) [1812LS-105XJ](#) [1812LS-124XJ](#) [1812LS-154XJ](#) [1812LS-223XJ](#) [1812LS-224XJ](#) [1812LS-563XJ](#) [1812LS-683XJ](#)
[1812LS-824XJ](#) [NIN-FB101JTR110F](#) [NIN-FB471JTR62F](#) [NIN-FC1R5JTR220F](#) [NIN-HCR15JTRF](#) [NIN-HCR33JTRF](#) [NIN-HDR22JTRF](#)