

SPECIFICATIONS

- 1、 Current Rating: 1A AC, DC
- 2、 Voltage Rating: 125V AC, DC
- 3、 Temperature Range: -25°C ~ +85°C
- 4、 Contact Resistance: 20mΩ Max
- 5、 Insulation Resistance: 100MΩ Min
- 6、 Withstanding Voltage: 500V AC/minute
- 7、 Material: PA66, UL94V-0

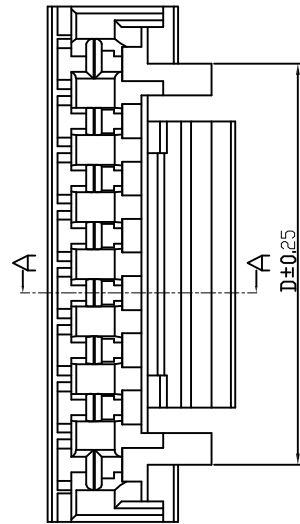
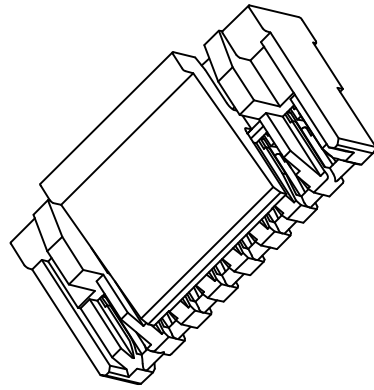
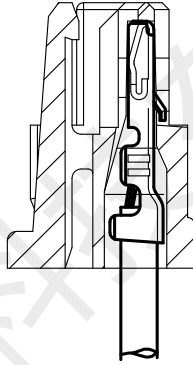
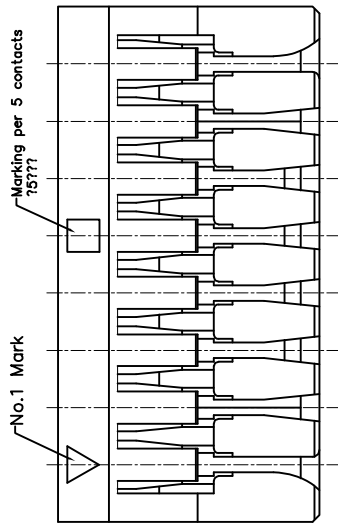
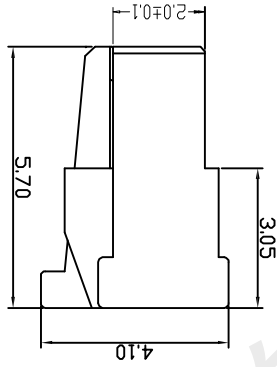
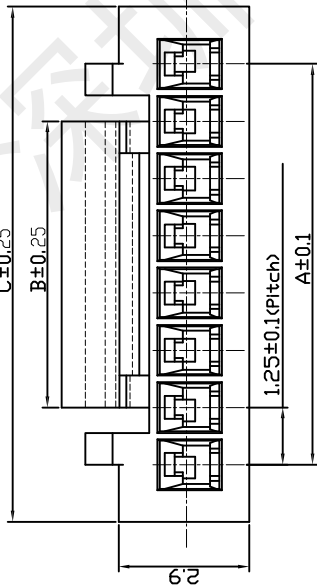

孔位 Poles	尺寸 (mm)			
	A	B	C	D
2Y	1.25	2.00	3.75	—
3Y	2.50	3.20	5.00	—
4Y	3.75	4.00	6.25	—
5Y	5.00	4.00	7.50	—
6Y	6.25	6.25	8.75	—
7Y	7.50	6.25	10.00	—
8Y	8.75	6.25	11.25	8.75
9Y	10.00	6.25	12.50	9.75
10Y	11.25	8.20	13.75	11.00
11Y	12.50	8.20	15.00	11.00
12Y	13.75	8.20	16.25	11.00
13Y	15.00	8.20	17.50	11.00
14Y	16.25	8.20	18.75	11.00
15Y	17.50	8.20	20.00	11.00

GENERAL TOLERANCE	DRAWING	制图	李春风	料号	GH1.25-12Y	版本	A
	X.±0.25	审核	钟德华	加名	压线端子胶壳	REV.	1/1
.X±0.20	CHECK	核准	罗孝金	TITLE		SHEET	
.XX±0.15	APPROVAL	单位		客户料号			
.XXX±0.10	UNITS	MM		CUTL. NO.			
		SCALE	1:1				



深圳市首韩科技有限公司



深圳市首韩科技有限公司

SHENZHEN SHOUHAN TECHNOLOGY CO., LTD

Tel: 0755-27597601 Fax: 0755-27597491

承 认 书

SPECIFICATION FOR APPROVAL

商品编码 Part Code:

产品名称 Project:

压线端子胶壳

规格型号 Part No:

GH1.25-12Y

贵公司承认印 Approval signatures

料号/Part No.	签章/Signatures

日期 Date:

拟制/Drawn	李春风	
审核/Check	钟华华	
批准/Approved	罗孝金	

1、SCOPE: (适用范围)

1.1 This specification covers production and inspection of Connector.

本规范内容适用于本公司普通系列型条形连接器（针座）产品的生产与检验。

2、USE CONDITION: (使用条件)

2.1 Ambient temperature Range:-25℃~+85℃

环境温度：-25℃~+85℃

2.2 Applicable Wire Sizes:AWG#28

适用线规：AWG#28

2.3 Applicable PC board thickness:1.2~1.6mm

适用PC板厚度：1.2~1.6 mm

3、Appearance and Dimension: (外观及尺寸)

3.1 Appearance:Product surface without defect、dirt、crack、and mechanical damang, Contact without rust,plating not oxidized and not peeled.

产品表面不应有对制品有害的缺陷、污垢、裂痕及机械损伤；接触件无锈蚀、镀层氧化、脱落等现象。

3.2 Dimension:According to drawings

外形尺寸：依照附图

3.3 Exchangable:Exchangable with same specification products.

互换性：相同规格应能互换

4、Material:

材料 (以图纸为准)

P/N 零件名称	Type 类型	Material 材料	Finish 表面处理	Explain 说明
Terminal 端子	Contact 插簧	Phosphor bronze 锡青磷铜 厚 0.15mm	Tin Plating:3~4 μ m 镀锡: 3~4 μ m	RoHS Compliant
Housing 孔座	Plastic 塑壳	PA66 UL94V-0	Color:White 颜色: 白色	
Opening Wafer 开口针座	Contact 插针	Phosphor bronze 锡青磷铜 厚 0.30mm	Tin Plating:3~4 μ m 镀锡: 3~4 μ m	
	Plastic 塑壳	Nylon46 UL94V-0	Color: Beige 颜色: 米色	
Lips Wafer 闭口针座	Contact 插针	Phosphor bronze 锡青磷铜 厚 0.30mm	Gold Plating:3~4 μ " m 镀金: 3~4 μ " m	
	Plastic 塑壳	PBT UL94V-0	Color: White 颜色: 白色	
Tiepian Wafer 卧贴针座 立贴针座	Contact 插针	Phosphor bronze 锡青磷铜 厚 0.30mm	Tin Plating:3~4 μ m 镀锡: 3~4 μ m	
	Solder tabs 焊护耳	Phosphor bronze 锡青磷铜 厚 0.25mm	Tin Plating:3~4 μ m 镀锡: 3~4 μ m	
	Plastic 塑壳	Nylon46 UL94V-0	Color: Beige 颜色: 米色	

5、Electrical Performance:

电气性能

NO. 序号	Item 项目	Requirement 技术要求
5.1	Voltage Rated 额定电压	125V AC DC
5.2	Current Rated 额定电流	1A AC DC
5.3	Contact Resistance 接触电阻	$\leq 20 \text{ m}\Omega$
5.4	Insulation Resistance 绝缘电阻	$\geq 100 \text{ M}\Omega$
5.5	Dielectric Strength 耐压	$\geq 500 \text{ V AC/minute}$

6、Mechanical Performance:

机械性能

NO. 序号	Item 项目	Requirement 技术要求
6.1	Male contact Retention force PIN 针固定力	$\geq 10 \text{ N}$ per pin
6.2	Female contact Retention force 端子固定力	$\geq 10 \text{ N}$ per pin
6.3	Plug-in force 插入力	$\leq 3 \text{ N}$ per pin
6.4	Plug-out force 拔出力	$\geq 0.5 \text{ N}$ per pin

7、Endurance Characteristics:

环境性能

NO. 序号	Item 项目	Requirement 技术要求
7.1	Soldering rest 可焊性	Time: $2.5 \pm 0.5 \text{ S}$ 时间: $2.5 \pm 0.5 \text{ S}$ Temperature: $260 \pm 5^\circ \text{C}$ 温度: $260 \pm 5^\circ \text{C}$ Area of Soldering: $\geq 95\%$ 焊锡面积: $\geq 95\%$

7.2	Resistance to soldering Heat 耐焊接热	Time: $5 \pm 1S$ 时间: $5 \pm 1S$ Temperature: $260 \pm 5^{\circ}C$ 温度: $260 \pm 5^{\circ}C$ Appearance: NO Damage 外观: 无损坏
7.3	Heat test 耐热性	Time: 96h 时间: 96 小时 Temperature: $+85 \pm 3^{\circ}C$ 温度: $+85 \pm 3^{\circ}C$ Appearance: NO Damage 外观: 无损坏 Contact resistance: $\leq 20 m\Omega$ 接触电阻: $\leq 20 m\Omega$
7.4	Cold test 耐冷性	Time: 48h 时间: 48 小时 Temperature: $-25 \pm 3^{\circ}C$ 温度: $-25 \pm 3^{\circ}C$ Appearance: NO Damage 外观: 无损坏 Contact resistance: $\leq 20 m\Omega$ 接触电阻: $\leq 20 m\Omega$
7.5	Temperature Cycling 温度循环	Low temperature: $-25 \pm 3^{\circ}C$ 低温: $-25 \pm 3^{\circ}C$ High temperature: $85 \pm 3^{\circ}C$ 高温: $85 \pm 3^{\circ}C$ For 5 cycles. test after keeping in Normal Condition for 30 min. 5 次循环后, 放置在正常环境中 30 分钟, 在进行测试 Appearance: NO Damage 外观: 无损坏 Contact resistance: $\leq 20 m\Omega$ 接触电阻: $\leq 20 m\Omega$

<p>7.6</p>	<p>Invariab lenes humidity 恒定湿热</p>	<p>Temperature: $60 \pm 2^{\circ}\text{C}$ 温度: $60 \pm 2^{\circ}\text{C}$</p> <p>Relative humidity: 90%-96% RH 相对湿度: 90%-96% RH</p> <p>Tim: 96h 时间: 96 小时</p> <p>Appearance: NO Damage 外观: 无损坏</p> <p>Contact resistance: $\leq 20 \text{ m}\Omega$ 接触电阻: $\leq 20 \text{ m}\Omega$</p> <p>Insulation Resistance: $\geq 100 \text{ M}\Omega$ 绝缘电阻: $\geq 100 \text{ M}\Omega$</p>
<p>7.7</p>	<p>Salt Spray 盐雾试验</p>	<p>Salt concentration: $5 \pm 1\%$ 浓度: $5 \pm 1\%$</p> <p>Temperature: $35 \pm 2^{\circ}\text{C}$ 温度: $35 \pm 2^{\circ}\text{C}$</p> <p>Tim: $16 \pm 2\text{h}$ 时间: 16 ± 2 小时</p> <p>After salt is removed by running wafer and A drop is removed ,it is measured.</p> <p>把试验样品从试验箱顶悬挂下来, 采用浓度 (5 ± 1) %的氯化钠溶液, 连续雾化 16 小时, 试验后用流动的蒸馏水轻轻洗去表面沉积物, 在常温常驻湿条件下恢复 1-2 小时, 外观无损伤</p> <p>Appearance: NO Damage 外观: 无损坏</p> <p>Contact resistance: $\leq 20 \text{ m}\Omega$ 接触电阻: $\leq 20 \text{ m}\Omega$</p>

8、Packaging Transportation Storage

包装、运输、贮存

8.1 Packaging

包装

- (1) **The packing of plastic inner is the plastic bag,the packing of inner terminal is panel mounting attach material packing, marked with product name, specification model, quantity, date in produced.**

塑件内包装为塑料袋，端子内包装为盘装带料包装，装（贴）入合格证，注明产品名称、规格型号、数量生产日期

- (2) **Exterior package is carton, facing the packing list, the packing list marked with product name, specification model, quantity, date of dispatch.**

外包装为纸箱，贴装箱单、装箱单上注明产品名称、规格型号、数量、出货日期

- (3) **The product in the box must not rock.**

产品在箱内不晃动

8.2 Transportation

运输

Allow for any way transportation, can't get wet and mechanical in jury.

允许用任何方式运输，勿淋湿及机械性损伤

8.3 Storage

贮存

The connector of packing finished should be in the ambient temperature between-10℃ to+40℃, Relative humidity≤80%. To store in storehouse does not have acidic, alkaline air and other corrosive gas in the ambient air.

包装完毕的连接器应在环境温度为-10℃~+40℃，相对湿度≤80%，周围空气中没有酸性，碱性及其它腐蚀性气体的库房中贮存

X-ON Electronics

Largest Supplier of Electrical and Electronic Components

Click to view similar products for [Headers & Wire Housings](#) category:

Click to view products by [SHOU](#) manufacturer:

Other Similar products are found below :

[57102-F02-18ULF](#) [58102-G61-06LF](#) [582553-1](#) [009176003701906](#) [01.001.5753.1](#) [0050291907](#) [02.125.8002.8](#) [609-3404](#) [61062-3](#)
[CSU011177004](#) [622-0430](#) [622-3653LF](#) [63453-116](#) [636-1030](#) [636-1427](#) [636-3427](#) [636-4007](#) [641938-9](#) [65495-038](#) [65692-001LF](#) [65781-018](#)
[65781-047](#) [65817-010LF](#) [65817-015LF](#) [66207-023LF](#) [67095-007LF](#) [67601157](#) [68631-112](#) [68645-018](#) [699319-000](#) [M90C108951C](#)
[70.362.1628.0](#) [70-4210](#) [70-4226B](#) [70-4853B](#) [707-5028](#) [71.350.2428.0](#) [71961-016LF](#) [733-134](#) [733-162](#) [754199-000](#) [760-3052](#) [80.063.4001.1](#)
[800-90-001-10-001000](#) [800-90-010-10-002000](#) [801-43-002-10-013000](#) [801-43-006-10-002000](#) [803-41-018-10-001000](#) [803-43-024-10-](#)
[001000](#) [803-93-012-10-001000](#)