

16	15	14	13	12	11	10	9	8	7	6	5	4	3	2	1
16	15	14	13	12	11	10	9	8	7	6	5	4	3	2	1
16	15	14	13	12	11	10	9	8	7	6	5	4	3	2	1
16	15	14	13	12	11	10	9	8	7	6	5	4	3	2	1

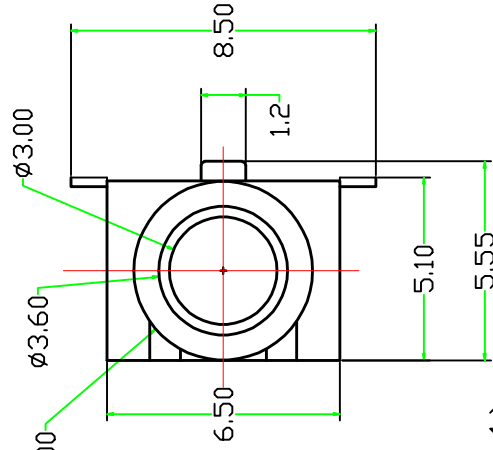

印制板开孔尺寸(± 0.1)

显示为底面

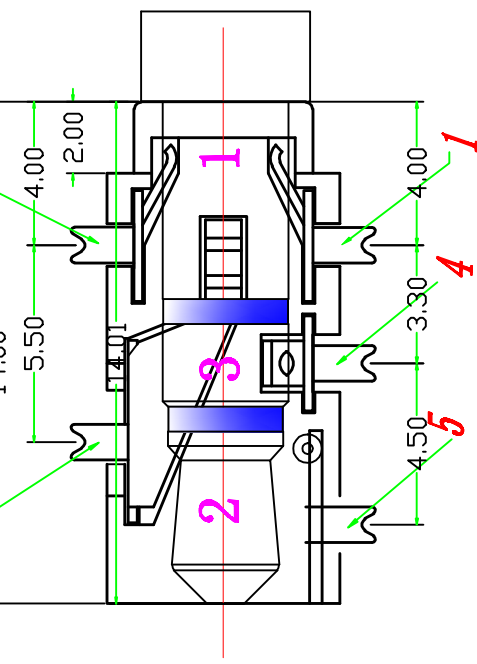
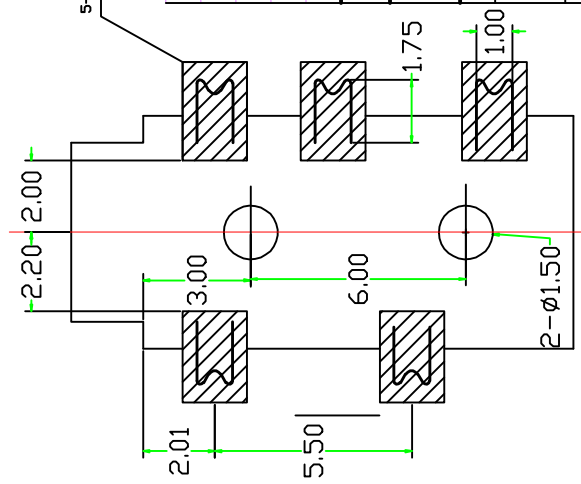
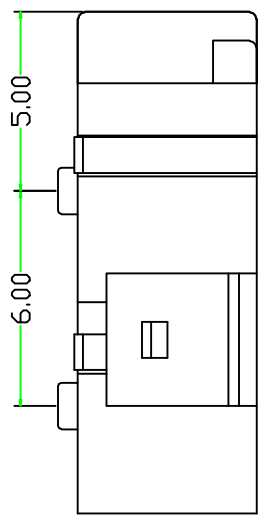

所有物质均符合环保要求

电原理图

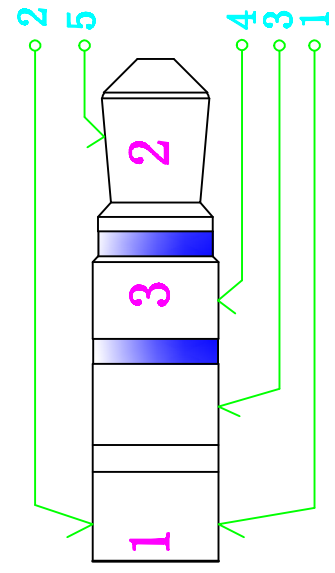

序号	名称	数量	零件图号	对应端子号	材质	颜色/镀层
⑤	底座	1	CX3.5-327A-06		PPA	黑色
④	4号插片	2	CX3.5-327A-04	4	Qsn6.5-0.1t=0.25	Ag
③	3号插片	1	CX3.5-327A-03	3	Qsn6.5-0.1t=0.25	Ag
②	2号插片	1	CX3.5-327A-02	2	Qsn6.5-0.1t=0.2	Ag
①	1号插片	1	CX3.5-327A-01	1	Qsn6.5-0.1t=0.2	Ag

深圳市首韩科技有限公司

角度	±2°	设计	李善凤	日期	2020.6.10	总称:	耳机插口
L > 10	±0.3	审核	钟国华	日期	2020.6.10	料号:	PJ-327F-Y
6 < L ≤ 10	±0.2	批准	罗孝金	日期	2020.6.10	质量	0.365g
L ≤ 6	±0.1	图号		比例	1/1	页码	A
单位:mm						版本	A4



深圳市首韩科技有限公司
SHENZHEN SHOUHAN TECHNOLOGY CO., LTD
Tel: 0755-27597601 Fax: 0755-27597491

承 认 书
SPECIFICATION FOR APPROVAL

客 户 Customer:

产品名称 Project:

耳机座

规格型号 Part No:

PJ-327F-Y

贵公司承认印 Approval signatures

料 号/Part No.	签 章/Signatures

日期 Date:

拟制/Drawn	李春风	
审核/Check	钟华华	
批准/Approved	罗孝金	

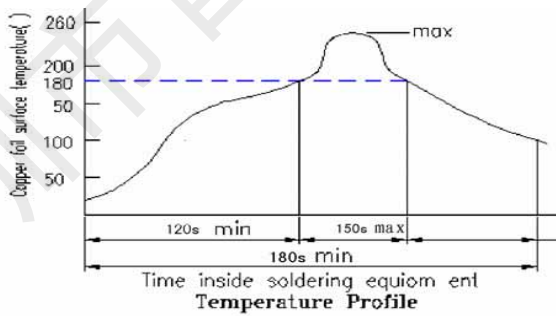

DESCRIPTION 名称: PHONE JACK MODEL NO.: PJ-327F-Y			
RATING (额定值): DC 30V 0.5 A			
PRACTICAL TEMPERATURE RANGE 使用温度范围	-30~70° C 在-30° C~+70° C 温度内使用		
STANDARD ATMOSPHERIC CONDITIONS 测试标准状况	UNLESS OTHERWISE SPECIFIED THE STANDARD RANGE OF ATMOSPHERIC CONDITIONS FOR MAKING MEASUREMENTS AND TESTS ARE AS FOLLOWS: (1) BETWEEN BODY AND CONDUCTOR: 5° C TO 35° C (2) BETWEEN CONDUCTORS NOT TO BE CONTACT: 45% TO 85% (3) PRESSURE: 86Kpa TO 106Kpa 在没有指定的情况下测试温度、湿度、气压如下: (1) 温度为 5° C~35° C (2) 湿度为 45%~85% (3) 气压为 86 Kpa~106Kpa		
MECHANICAL (机械性能)			
ITEM 项目	TEST CONDITIONS 测试条件	PERFORMANCE 规格	
1	CONNECTION FORCE 插入力度	MEASUREMENT SHALL BE MADE AFTER CONNECTING AND DISCONNECTING USING STANDARD PLUG GAUGE 3 TIMES. 依据标准的 PLUG GAUGE 做第 3 次拔插后测定	3 ~ 20N
	DISCONNECTION FORCE 拔出力度	MEASUREMENT SHALL BE MADE AFTER CONNECTING AND DISCONNECTING USING STANDARD PLUG GAUGE 3 TIMES. 依据标准的 PLUG GAUGE 做第 3 次拔插后测定	3 ~ 20N
2	TERMINAL STRENGTH 端子强度	A STATIC LOAD OF 0.1N/m(1kgf/cm) SHALL BE APPLIED TO THE TIP OF THE TERMINAL FOR 1 MIN IN ANY DIRECTION 向排脚先端的任意一个方向加 1 分钟 0.1N/m(1kgf/cm)的力度.	THERE SHALL BE NO DAMAGE TO THE TERMINAL SUCH AS CRACKS, LOOSENESS OR PLAY ELECTRICAL, AND MECHANICAL CHARACTERISTICS SHALL BE SATISFIED 在排脚中没有裂开、松动等异常, 满足于机械、电气性能
ELECTRICAL (电气性能)			
ITEM 项目	TEST CONDITIONS 测试条件	PERFORMANCE 规格	
3.1	CONTACT RESISTANCE 接触电阻	MEASURED AT SMALL CURRENT (100mA OR LESS) 1000Hz 在微小电流 (100 mA) 以下测试	$\leq 30m\Omega$
3.2	INSULATION RESISTANCE 绝缘电阻	APPLY A VOLTAGE OF 500V DC FOR 1 MIN TO FOLLOWING PORTIONS AFTER WHICH MEASUREMENT SHALL BE MADE: (1) BETWEEN BODY AND CONDUCTOR (2) BETWEEN CONDUCTORS NOT TO BE CONTACT (3) BETWEEN CONDUCTORS NOT TO BE WHEN PLUG IS INSERTED DC 500V 1 MIN 输入 500V DC 电压 1 分钟, 按以下接触方法测试: (1) 插座体与排脚之间 (2) 不接触的排脚之间 (3) 插头插入时不接触排脚之间	$\geq 100M\Omega$

3.3	<p>DIELECTRIC STRENGTH 耐电压</p>	<p>AC 500V ims(50~60Hz)FOR 1 MIN TRIP CURRENT:0.5mA (1) BETWEEN BODY AND CONDUCTOR (2) BETWEEN CONDUCTORS NOT TO BE CONTACT (3) BETWEEN CONDUCTORS NOT TO BE WHEN PLUG</p> <p>输入 AC 500V (50Hz) /min 电压 1 分钟感度电流为 0.5mA, 按以下接触方法测试: (1) 插座体与排脚之间 (2) 不接触的排脚之间 (3) 插头插入时不接触排脚之间</p>	<p>WITHOUT DAMAGE TO PARTS ARCING OR BREAKDOWN ETC 没有绝缘破坏等异常</p>
URABILITY (耐久性)			
ITEM 项目		TEST CONDITIONS 测试条件	PERFORMANCE 规格
4.1	<p>SOLDERABILITY TEST 可焊性试验</p>	<p>THE TOP OF THE TERMINALS SHALL BE DIPPED 1mm IN THE SOLDER BATH OF 240±5°C FOR 3±0.5 SECONDS 端子顶部被浸入锡池中 1mm 深,温度为 240±5°C,时间为 3±0.5 秒</p>	<p>(1) SOLDER WETTING TIME SHALL BE 3 SEC OR LESS 焊接时间应少于 3 秒 (2) THE AREA OF SOLDERING SHOULD BE OVER 75% 焊接面积应有 75% 以上</p>
4.2	<p>RESISTANCE TO SOLDERING HEAT TEST 耐焊性试验</p>	<p>REFLOW SOLDERING CONDITIONS: PREHEAT:TEMPERATURE ON THE COPPER FOIL SURFACE SHOULD REACH 180 .120S AFTER THE P.C.B ENTERED INTO THE SOLDERING EQUIPMENT. TALLEST TEMPERATURE:TEMPERATURE ON THE COPPER FOIL SURFACE SHOULD REACH THE PEAK TEMPERATURE OF 260±5 WITH IN 20 SECONDS. 过回流焊条件: 预热:电镀层表面的温度应达到180℃, 120s 后电路板进入回 流焊设备。最高温度:电镀层表面温度最高为 260±5℃且 停留不超过 20秒。</p>  <p style="text-align: center;">Temperature Profile</p>	<p>WITHOUT DEFOR MATION OF CASE OR EXCESSIVE LOOSENESS OF TEMINALS ELECTRICAL CHARACTERISTICS SHALL BE SATISFIED 本体无变形, 满足于机械、电气性能</p>
4.2	<p>RESISTANCE TO SOLDERING HEAT TEST 耐焊性试验</p>	<p>SOLDERING IRON METHOD: BIT TEMPERATURE: 330±5°C APPLICATION TIME OF SOLDERING IRON3±0.5 SEC HOWEVER EXCESSIVE PRESSURE SHALL NOT BE APPLIED TO THE TERMINAL 手焊接的时候温度需控制在 330±5℃ , 时间为 3±0.5 秒, 但不能在排脚上施加异常压力。</p>	<p>WITHOUT DEFORMATION OF CASE OR EXCESSIVE LOOSENESS OF TEMINALS ELECTRICAL CHARACTERISTICS SHALL BE SATISFIED 本体无变形, 满足于机械、电气性能</p>

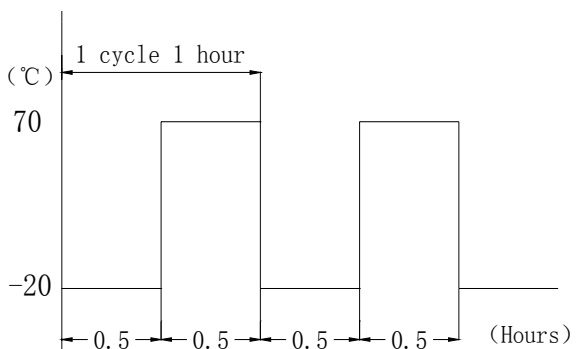
4.3	<p>HUMIDITY TEST 潮湿试验</p>	<p>THE JACK SHALL BE STORED AT A TEMPERATURE OF $40 \pm 2^{\circ}\text{C}$ AND A HUMIDITY OF 90% TO 96% FOR 96 Hr, THEN THE JACK SHALL BE MAINTAINED AT STANDARD ATMOSPHERIC CONDITION FOR 1 Hr FOR OTHER PROCEDURES</p> <p>放置 $40 \pm 2^{\circ}\text{C}$ 的相应湿度为 90~96% Hr 环境中 96 小时后, 再将样板放在正常环境中 1 小时后进行测试</p>	<p>THERE SHALL BE NO DAMAGE ON APPEARANCE.</p> <p>MECHANICAL AND ELECTRICAL CHARACTERISTICS SHALL BE SATISFIED</p> <p>外观无异常, 满足于机械、电气性能。</p>
4.4	<p>HEAT TEST 耐热试验</p>	<p>THE JACK SHALL BE STORED AT A TEMPERATURE OF $70 \pm 2^{\circ}\text{C}$ FOR 96 HOURS, AND THEN IT SHALL BE SUBJECTED TO THE CONTROLLED RECOVERY MBASURBM</p> <p>放置在温度 $70 \pm 2^{\circ}\text{C}$ 中测试 96 小时后, 再放置正常室温中 1 小时来测定</p>	
4.5	<p>COLD TEST 耐寒试验</p>	<p>THE JACK SHALL BE STORED AT A TEMPERATURE OF $-25 \pm 3^{\circ}\text{C}$ FOR 96 HOURS AND THEN IT SHALL BE SUBJECTED TO THE CONTROLLED RECOVERY CONDITIONS FOR 1 HOUR AFTER WHICH</p> <p>放置在温度 $-25 \pm 3^{\circ}\text{C}$ 中 96 小时后, 再放置常温常湿中 1 小时来测定</p>	<p>THERE SHALL BE NO DAMAGE ON APPEARANCE</p> <p>MECHANICAL AND ELECTRICAL CHARACTERISTICS SHALL BE SATISFIED</p> <p>外观无异常, 满足于机械、电气性能</p>
4.6	<p>LIFE TEST 寿命试验</p>	<p>AT RATING CONDITION (NON-INDUCTIVE LOAD) CONNECTION AND DISCONNECTION SHALL BE MADE 5000 CYCLES AT A SPEED 10 TO 20 CYCLES / MIN</p> <p>以定格状态(无诱导负荷)在 1 分钟内以 10~20 次的速度进行 5000 次插入、拔出</p>	<p>1. CONTACT RESISTANCE SHALL BE $\leq 0.1 \Omega$</p> <p>2. DISCONNECTION FORCE SHALL BE 3 TO 20N</p> <p>3. MECHANICAL AND ELECTRICAL CHARACTERISTICS SHALL BE SATISFIED</p> <p>(1) 接触电阻 $\leq 0.1 \Omega$</p> <p>(2) 拔出力是 3~20N</p> <p>(3) 其它: 满足于机械、电气性能</p>
4.7	<p>COLD&HEAT SHOCK TEST 冷热冲击测试</p>	<p>THE JACK SHALL BE SUBJECTED TO 5 CYCLES OF THE FOLLOWING CONDITIONS SHOWN IN THE FIGURE, AND THEN SHALL RETURNED AND ALLOWED TO REMAIN IN ROOM AMBIENT CONDITION FOR 30 MINUTES</p> <p>将插座以下列条件作 5 个循环, 然后放回室内环境 30 分钟 TEMP ($^{\circ}\text{C}$)</p>  <p>The graph shows a square wave temperature profile. The y-axis is labeled '(°C)' with values 70 and -20. The x-axis is labeled '(Hours)' with values 0.5 and 1. A horizontal line at 70°C is shown for 0.5 hours, followed by a vertical drop to -20°C, then a horizontal line at -20°C for 0.5 hours, and a vertical rise back to 70°C. This sequence is labeled '1 cycle 1 hour'. The total duration for 5 cycles is 5 hours.</p>	<p>THERE SHALL BE NO DEFORMATION OR CRACKS IN MOLDED PART.</p> <p>INSERTION & EXTRACTION FORCE: 3 TO 20N</p> <p>CONTACT RESISTANCE: MAX. $30 \text{m}\Omega$</p> <p>INSULATION RESISTANCE: MIN. $100 \text{M}\Omega$</p> <p>DIELECTRIC WITHSTANDING VOLTAGE: 500VAC/MIN (BETWEEN TERMINALS)</p> <p>产品不能变形与破裂</p> <p>插拔力: 3N 至 20N</p> <p>接触电阻: 最大 $30 \text{m}\Omega$</p> <p>绝缘电阻: 最小 $100 \text{M}\Omega$</p> <p>绝缘耐压: 最小 500VAC (端子之间)</p>

X-ON Electronics

Largest Supplier of Electrical and Electronic Components

Click to view similar products for [HDMI, Displayport & DVI Connectors](#) category:

Click to view products by [SHOU](#) manufacturer:

Other Similar products are found below :

[30-528](#) [30-504](#) [33DVIR-24S1B](#) [47648-2000](#) [TC142X](#) [1932649-1](#) [HAGBH](#) [AABII](#) [ABIBG](#) [AAIBH](#) [52355](#) [XHLJQ-00026](#) [HDMI-019R](#)
[G46M2013201AWEU](#) [ST-0277D00-052-142](#) [HC-PJ-320A-3P-D](#) [HC-PJ-3133-5P-D](#) [PJ-342](#) [141](#) [PJ-320A-4P](#) [DIP](#) [HC-PJ-325C-5P](#) [HC-PJ-](#)
[320D-4P-S](#) [HC-PJ-3133-6P-S](#) [D-SUB-DR-9PCM-CB](#) [ST-0275S00-082-182](#) [HC-PJ-320A-4P-D](#) [HC-PJ-325A-5P](#) [HC-PJ-3134-6P-D](#) [HDR-](#)
[HX-102DIP](#) [HDMI-GD-121PWB](#) [C2939191](#) [C2939584](#) [PJ-208](#) [PJ-2040](#) [PJ-3580A-6A](#) [PJ-399M](#) [PJ-3200A-3A](#) [PJ-328B-4B](#) [PJ-3930-7A](#)
[PJ-615-5A](#) [PJ-332-6A](#) [KH-HDMI-0001](#) [KH-PJ-209-SMT](#) [KH-HDMI-0035-XK](#) [KH-PJ-328A-5P](#) [KH-PJ-322](#) [KH-PJ-327E-SMT](#) [KH-PJ-](#)
[320A-5.6](#) [KH-HDR15P-F3.08](#) [KH-HDMI-0005A-SMT](#) [KH-HDMI-0021-JBS](#)