



深圳市首韩科技有限公司

SHENZHEN SHOUHAN TECHNOLOGY CO., LTD

Tel: 0755-27597601 Fax: 0755-27597491

承认书
SPECIFICATION FOR APPROVAL

客户 Customer:

产品名称 Project:

轻触开关

规格型号 Part No:

TS365TP

贵公司承认印 Approval signatures

料号/Part No.	签章/Signatures

日期 Date:

拟制/Drawn	李春风	
审核/Check	张栋	
批准/Approved	罗孝金	



产 品 规 格 书

PRODUCT SPECIFICATION

SIRLES		系列:FLIP SWITCHES(轻触开关)	
MODEL		型号: TS365TP	
1.RATING		额定值:50Ma 12VDC	
2.CONSTRUTION DIMENSION 结构尺寸		Apply to the appended drawing:符合附加图纸	
3.APPEARANCE 外观		Have no remarkable damage,crack and rust etc:无明显损伤,裂纹,锈迹等.	
4.CONTACTLOOP 接触回路		Monople loop:单通单极回路	
ITEM 专案		TEST CONDITION 测试条件	SPECIFICATION 规格
5.CAPABILITY OF ELECTRIC 电气性能			
5A	INSULATION RESISTANCE 绝缘电阻	Measurements shall be made following Application of DC500V potential across terminals and across terminals and fuame for 1minute,在端子之间和端子与壳之间加 DC500V 条件下,持续 1 分钟测量.	100M Ω min 100 兆欧以上.
5B	WITHSTAND VILTAGE 耐电压	AC250V、50HZ、1 min (imin(interrupting current \leq 500uA). AC250V、50HZ、1 分钟(漏电流 500uA)	There shall be no briakdown 无击穿现象出现。
5C	CONTACT CIRCUIT 接触电路	Addition 1.5-2 time force on the top of the keystrok and press the switch,DC50V100mA 在按键顶端上等于作用力 1.5-2 倍的力按动开关,DC50V,10Ma.	50m Ω Max (50m Ω 以下).
5D	SWITCH CONNECTION FLASH 开关接触点抖动	Addition DC5V on the two side of switch,at a speed of 3-5time a sec.to press the switch.在开关的两端加 DC5V 的电压,以 3-5 次/秒的速度按动开关.	The flash time between open not more than 10ms. 开关在接通和断开时的接点抖动时间不大于 10 ms.
6.MECHANICAL EFFICIENCY 机械性能			
6A	CONTACT STRENGTH 按键强度	The contact shall be capable of a rorce of 5N for 5 seconds in any directions.沿开关动作方向可承受静能压力 5N, 保持 5 秒钟.	Switch electric andmechanical efficiency does not break 无损开关电气或者机械性能
6B	CONTACT JOURNEY		按键行程 :0.25 \pm 0.1
6C	DRIVE FORCE 驱动力	Being measure at across spring piece and across keystoke forergometer.用测力计在按键与弹片之间测量.	Contact switch'sd drive dirive fouce was250 \pm 50gf. 按键的开关驱动力为 250 \pm 50gf
6D	CONNECTION	A force of 1N being appling in any directions of the	Switch mechanical



	STRENGTH 接线端强度	switch connection partt..在接线端的作用方向施加 1N 的力.	efficiency does not break.无损开关机械性能.
6E	MECHANICAL LIFE 机械寿命	Operatin at a rate of 30-50 cycles a minute. 以 30-50 次/分的驱动速度操作.	Life:50000cycles 寿命:50000 次
7.ENVIRONME NT---RESISTANT EFFICIENCY 耐环境性能			
7A	CHANGE OF TEMPERATURE 温度变化	The first temperature shall be 70 °C ,3h and changed to-25°C, 0.5h, 5cycles of above test. 先 70°C, 3h, 然后-25°C, 0.5h, 如此重复 5 次.	1. The appearance should not break.外观应无损伤. 2. Contact resistance $\leq 100 M \Omega$ 接触电阻 $\leq 100M \Omega$
7B	HUMIDITY RESISTANT 耐湿热	40 \pm 2°C in temperature and 90-95%RH, Ruring the test time without load; After testing the temperature should be 24h. 经 40 \pm 2°C, 相对湿度 90-95%, 试验期间, 开关不动作, 不带电负荷, 试验后恢复到常温 24h.	3. Insulation resistance $\geq 100 M \Omega$. 绝缘电阻 $\geq 100 M \Omega$
8.JOINTING EFFICIENCY 焊接性能			
8A	SOLDERABILITY 可焊性	Temperature260 \pm 5 °C ;Duration;3 \pm 0.5S:温度在 260 \pm 5°C, 持续 3 \pm 0.5S.	Solderability part should above 90% 可焊部分被焊料覆盖面应在 90% 以上.
8B	SOLDER—RESISTANT 耐焊剂性	Warm-up temperature:100°C,40S, 焊锡温度 260 \pm 5 °C, 浸焊时间 3 \pm 0.5S.	Froth height of assist solder should under board and switch electric and mechanical efficiency does not break.助焊剂发泡不应超过印制板,无损伤开关电气或机械动作性能.
8C	JOINTING—RESISTANT 耐焊接热	Jointing temperature: 260 \pm 5 °C ,Duration of immersion: 5 \pm 1S. 焊锡温度 260 \pm 5°C, 浸焊时间 5 \pm 1S	efficiency does not break 无损伤开关电气或机械动作性能.
8D	NORMAL JOLNTING TIMES 正常焊接次数		≤ 2 times 小于 2 次
9.NOTES			
9A	The whole boxes of switch should keep in the temperature -30--80°C and less than 80%RH withort acidic, alkalescence, caustic gas in the environment of the storage. 整箱包装的开关, 应在温度为-30--80°C, 相对湿度不大于 80%, 周围的空气中没有酸性、碱性或其他腐蚀性气体的库房内保管。		
9B	Operating Temperature Range:-20 to 70°C 操作温度的范围: -20 to 70°C		
9C	Switch should install in a correct method. 开关应按正确的安装方法进行正确安装使用。		

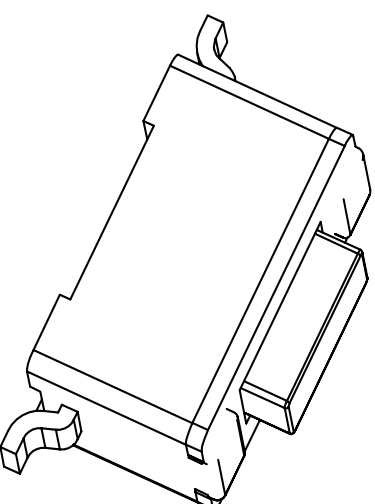
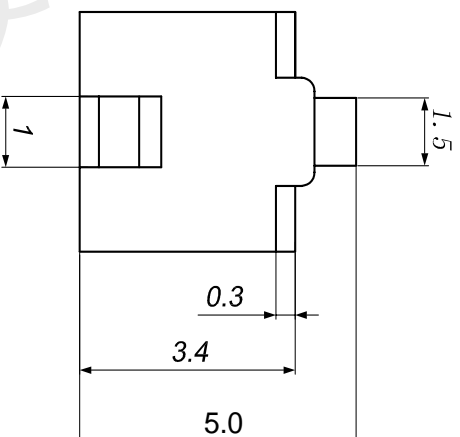
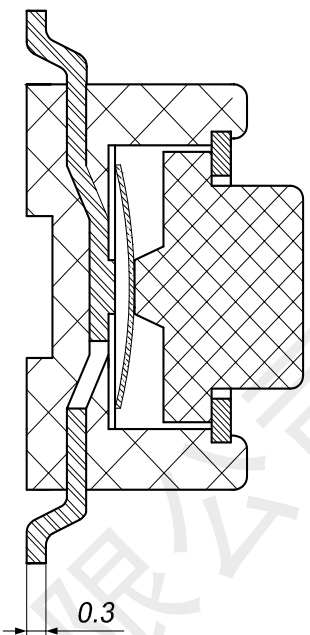

1. Rating: DC12V 50mA.
2. Travel: 0.25 ± 0.1 mm.
3. Operating Force: 260 ± 30 gf.
4. Contact Resistance: $50m\Omega$ Max.
5. Life: 50,000 Cycles Min.

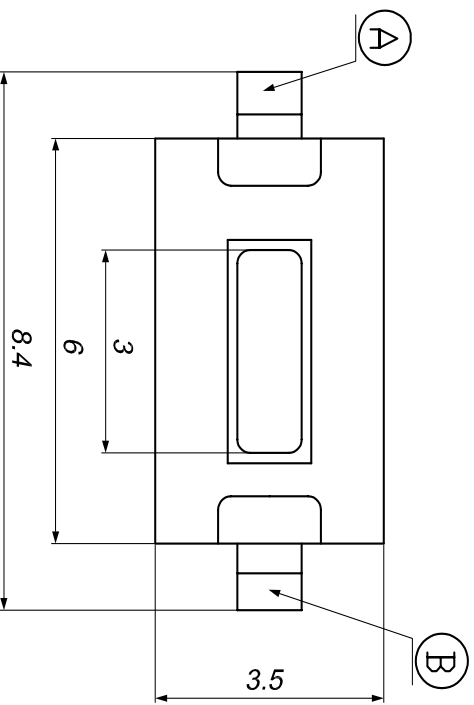

电路简图
SCHEMATIC

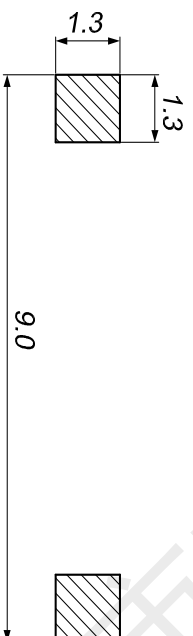
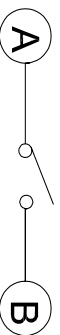

印制线路板
Recommended P.C.B layout

工程变更通知单 EON(DCN) NO.	版本 REV	日期 DATE	说明 DESCRIPTION	变更 CHANGE	承認 APPRO.	GENERAL TOLERANCE UNLESS OTHERWISE NOTED	Angle	±2°	DRAW	繪圖員	李春风
	PO	01/06/04	NEW			30~	±0.5	DESIGN	設計		
						10~30	±0.3	CHECH	校閱	张栋	
						~ 10	±0.15	APPRO.	承認	罗孝金	

序号 NO.	名称 DESCRIPTION	材料 MATERIAL	颜色 COLOR	备注 REMARK
5	盖板	黄铜	—	镀铜锡
4	按钮	PPA	白	—
3	弹片	覆银铜	—	进口
2	基座	PPA	白	—
1	嵌件	黄铜	—	镀银

首韩
SooKhan
深圳市首韩科技有限公司

CUSTOMER COPY 名稱: 外形: 轻触开关

图號 DRAWING NO.	圖號 SCALE	UNIT	mm	A4
TS365TP	5:1			

X-ON Electronics

Largest Supplier of Electrical and Electronic Components

Click to view similar products for [Tactile Switches](#) category:

Click to view products by [SHOU](#) manufacturer:

Other Similar products are found below :

[KMR633NG](#) [LFG](#) [5GTH92001](#) [5GTH9202242](#) [6426-201-11343](#) [MJ1226](#) [MJTP1109B](#) [MJTP1138EAUTR](#) [MJTP1230BL](#) [MJTPSHW](#)
[GS6.90F300QP](#) [1-1977223-0](#) [1-1977120-4](#) [ADTSA62NV](#) [ADTSA62RV](#) [ADTSA63KV](#) [ADTSA644NV](#) [ADTSM24NVTR](#) [ADTSMW66NV](#)
[ADTSMW67RV](#) [ATM533VTR](#) [1571300-3](#) [B3F-3123](#) [B3F-6055A](#) [B3F-B32-01-KIT](#) [1977177-8](#) [1977266-1](#) [2-1977223-4](#) [2-1977223-7](#)
[ADTS644KV](#) [ADTSA61RV](#) [ADTSA62KV](#) [ADTSA63NV](#) [ADTSA63RV](#) [ADTSA65NV](#) [ADTSM21NSVTR](#) [ADTSM25RVTR](#)
[ADTSM31RVTR](#) [ADTSM32NVTR](#) [ADTSM61YVTR](#) [ADTSM63SVTR](#) [ADTSM644KVTR](#) [ADTSMW64RV](#) [ADTSMW69NV](#)
[FSMRA4JHA04](#) [GS4.70F300QP](#) [D38999/20JJ37SA](#) [TL1105B](#) [TL1105J](#) [ATH447K2Q](#) [ATM534VTR](#)