



深圳市首韩科技有限公司

SHENZHEN SHOUHAN TECHNOLOGY CO., LTD

Tel: 0755-27597601 Fax: 0755-27597491

承 认 书
SPECIFICATION FOR APPROVAL

客 户 Customer:

产品名称 Project:

轻触开关

规格型号 Part No:

TS36CA-0.6 250gf 031

贵公司承认印 Approval signatures

料 号/Part No.	签 章/Signatures

日期 Date:

拟制/Drawn	李春风	
审核/Check	钟华华	
批准/Approved	罗孝金	



TACT SWITCH SPECIFICATION

轻触开关产品规格书

File No.
文件编号

TS-B001-Y

Version
版本

A

一、GENERAL SPECIFICATION 基本说明

- 1.Scope 范围 This specification covers the requirements for single key switches which have no key.
(TACT SWITCHES: MECHANICAL CONTACT).此规范含盖单推柄和无推柄的轻触开关要求。
- 2.Operating Temperature Range 使用温度范围: -20 to 70 °C。
- 3.Storage Temperature Rang 保存温度范围: -20 to 80 °C。

二、TYPE OF ACTUATION 动作类型: Tactile feedback 轻触返回

三、MAXIMUM RATING 最大额定值: DC 12 V, 50 mA

四、TEST ITEM 测试项目

Characteristic 特性	Item 项次	Test Breed 测试种类	Test Condition 测试条件	Test Requirements 测试要求
Appearance 外观	1	Visual Check 目视检查	Without any external force applied and test prior to the visual way to test. 在未施加任何外力及试验前,以目视方式测试	Not affect the product appearance of products Bad function defects. 产品的外观不能有影响产品功能之不良缺点
Electrical Performance 电气特性	2	Contact Resistance 接触阻抗	Applying a static load twice the actuating force to the center of the stem, measurements shall be made with a 1 kHz small-current contact resistance meter. 用两倍的动作用作静负载施加于按钮的中心,并用1千赫小电流接触电阻仪测量。	100 mΩMax. 接触阻抗不得高于100mΩ
	3	Insulation Resistance 绝缘阻抗	Measurements shall be made following application of DC 100 V potential across terminals and across terminals and frame for one minute. 在端子之间,端子与外壳之间施加DC100V一分种。	100 MΩMin 绝缘阻抗不得低于100MΩ
	4	Dielectric Withstanding Voltage 电气耐压	AC250V (50Hz or 60Hz) shall be applied across terminals and across terminals and frame for one minute. 在端子与端子之间,端子与外壳之间施加AC250V(50Hz or 60Hz)。	There shall be no breakdown 没有击穿



TACT SWITCH SPECIFICATION

轻触开关产品规格书

File No.
文件编号

TS-B001-Y

Version
版本

A

Characteristic 特性	Item 项次	Test Breed 测试种类	Test Condition 测试条件	Test Requirements 测试要求
电气特性 Electrical Performance	5	Bounce 抖动	<p>Lightly striking the center of the stem at a rate encountered in normal use (3 to 4 operations per sec), Bounce shall be tested at “ON” and “OFF”.</p> <p>在正常使用中(以每秒 3-4 次周期)轻轻地在手柄中心加力，在通与断瞬间测试抖动。</p>	<p>5 m sec max . 最大为 5 毫秒</p>
机械特性 Mechanical	6	Actuating Force 动作力	<p>Placing the switch such that the direction of switch operation is vertical and then gradually increasing the load applied to the center of the stem, the maximum load required for the stem to come to a stop shall be measured.</p> <p>开关的动作方向为垂直放置开关向推柄中心逐渐增加负荷直到推柄停止时所测量的最大负荷。</p>	250±50 gf
	7	Travel 行程	<p>Placing the switch such that the direction of switch operation is vertical and then applying a static load twice the actuation force to the center of the stem, the travel distance for the stem to come to a stop shall be measured.</p> <p>按规定进行测量，测量时固定开关并使其操作方向垂直，然后向中心部分逐渐回压力，测量开关作动结束后最大的动作行程。</p>	0.2±0.1 mm



TACT SWITCH SPECIFICATION

轻触开关产品规格书

File No.
文件编号

TS-B001-Y

Version
版本

A

Characteristic 特性	Item 项次	Test Breed 测试种类	Test Condition 测试条件	Test Requirements 测试要求
机械 特性 Mechanical	8	Return Force 返弹力	The sample switch is installed such that the direction of switch operation is vertical and, upon depression of the stem in its center the whole travel distance, the force of the stem to return to its free position shall be measured. 开关的动作方向垂直放置开关, 在已有行程的推柄中心向上减小压力, 推柄回到自由位置时所测量到的力。	70gfMin
	9	Stop Strength 静止强度	Placing the switch such that the direction of switch operation is vertical, a static load of <u>3</u> kgf shall be applied in the direction of stem operation for a period of <u>60</u> seconds. 开关的动作方向为垂直放置开关, 在推柄动作方向施加 3 KG 的静负荷, 60 秒时间。	There shall be no sign of damage mechanically and electrically 无机械的和电气的损伤迹象
	10	Stem Strength 推柄强度	Placing the switch such that the direction of switch operation is vertical, the maximum force to withstand a pull applied opposite to the direction of stem operation shall be measured. 开关的动作方向为垂直放置开关从推柄动作方向反方向施加拉力所测量到的最大承受力。	3 kgf
环境 Environmental	11	Resistance to Low Temperatures 耐低温	Following the test set forth below the sample shall be left in normal temperature and humidity conditions for one hour before measurements are made: 样品按下列条件进行耐低温试验, 测试前在正常温度和湿度条例上放置 1 小时 (1) Temperature 温度: -30±2℃ (2) Time 时间: 96 hours (3) Water drops shall be removed 擦除水珠	Item 2~5 Item 6 Item 7



TACT SWITCH SPECIFICATION

轻触开关产品规格书

File No.
文件编号

TS-B001-Y

Version
版本

A

Characteristic 特性	Item 项次	Test Breed 测试种类	Test Condition 测试条件	Test Requirements 测试要求
Environmental 环境	12	Heat Resistance 耐热	<p>Following the test set forth below the sample shall be left in normal temperature and humidity conditions for one hour before measurements are made. 样品按下列条件进行耐热试验，测试前在正常温度和湿度条件下放置 1 小时</p> <p>(1) Temperature 温度: 80±2°C (2) Time 时间: 96 hours</p>	<p>Item 2~5 Item 6 Item 7</p>
	13	Moisture Resistance 耐潮湿	<p>Following the test set forth below the sample shall be left in normal temperature and humidity conditions for one hour before measurements are made: 样品按下列条件进行耐潮湿试验，测试前在正常温度和湿度条件下放置 1 小时</p> <p>样品按下列条件进行耐潮湿试验，测试前在正常温度和湿度条件下放置 1 小时</p> <p>(1) Temperature 温度: 60±2°C (2) Relative humidity 相对湿度: 90 to 95% (3) Time 时间: 96 hours (4) Water drops shall be removed 擦除水珠</p>	<p>Contact resistance: 200 m ohm max. Insulation resistance 10 M ohm min.</p> <p>1. 接触电阻最大 200 mΩ. 2. 绝缘电阻最小 10 MΩ.</p> <p>Item 2~5 Item 6 Item 7</p>
	14	Temperature Cycling 温度循环	<p>Following the test set forth below the sample shall be left in normal temperature and humidity conditions for one hour before measurements are made. 样品按下列条件进行温度循环试验，测试前在正常温度和湿度条件下放置 1 小时</p> <p>During this test, water drops shall be removed. 在试验期间，擦除水珠。</p>	<p>Item 2~5 Item 6 Item 7</p>



TACT SWITCH SPECIFICATION

轻触开关产品规格书

File No.
文件编号

TS-B001-Y

Version
版本

A

Characteristic 特性	Item 项次	Test Breed 测试种类	Test Condition 测试条件	Test Requirements 测试要求
Endurance 耐久性	15	Operating Life 动作寿命	<p>Measurements shall be made following the test set forth below:</p> <p>(1) DC 12V 50mA resistive load 阻性负载: DC 12V 50mA</p> <p>(2) Rate of operation : 2 to 3 operations per second 动作频率: 2-3 次/每秒。</p> <p>(3) Depression 动作力: $250 \pm 50gf$</p> <p>(4) Cycles of operation 动作次数 > 30,000 次。</p>	<p>1-Contact resistance: 1000m Ω Max 接触电阻</p> <p>2-Insulation resistance 10 M Ω min. 绝缘电阻</p> <p>3-action force attenuation rate was 15% of the initial value 动作力衰减率为初始值的 15%左右。</p>
	16	Vibration Resistance 耐振动	<p>Measurements shall be made following the test set forth below:按下下列条件进行抗振动试验</p> <p>(1)Range of oscillation: 10~55 Hz 频率范围</p> <p>(2)Amplitude pk to pk : 1.5mm 振幅: 峰-峰 1.5mm</p> <p>(3)Cycle of sweep : 10-55-10Hz in one minute.扫描周期: 10-55-10-Hz 约一分钟内。</p> <p>(4)Mode of sweep : Logarithmically sweep or uniform sweep. 扫描方式: 对数扫描或统一的扫描。</p> <p>(5)Direction of oscillation:振动方向 Three mutually perpendicular directions, including the direction of stem travel. 3个相互垂直方向, 包括推柄行程方向</p> <p>(6)Duration of testing 持续时间 2 hours each ,for a total of 6hours.. 每方向 2 小时, 共 6 小时</p>	<p>Item 2~5</p> <p>Item 6</p> <p>Item 7</p>
	17	Impact Shock Resistance 抗冲击	<p>Measurements shall be made following the test set forth below:按下下列条件进行冲击试验</p> <p>(1) Acceleration 加速度: 80g</p> <p>(2) Cycles of test :3 cycles each in 6 directions.for a total of 18 cycles. 试验次数: 每个方向 3 次, 6 个方向共 18 次</p>	<p>Item 2~5</p> <p>Item 6</p> <p>Item 7</p>

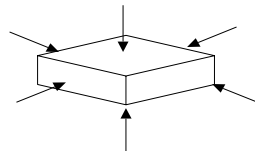



TACT SWITCH SPECIFICATION

轻触开关产品规格书

File No.
文件编号

TS-B001-Y

Version
版本

A

五、CONDITIONS FOR SOLDERING 焊接条件

Reflow soldering conditions 回流焊条件

Preheat: Temperature on the copper foil surface should reach 180°C, 2 ± 0.3 minutes after
The P.W.B entered into the soldering equipment.

预热: 在 P.W.B(印刷线路板)进入焊接设备后, 2 ± 0.3 分钟内铜箔表面要达到 180°C

Soldering heat: Temperature on the copper foil surface should reach the peak temperature of 265°C
within 20 seconds after the P.W.B entered into soldering heat zone.

焊接温度: 在 P.W.B (印刷线路板)进入焊接温区 20 秒内, 铜箔表面达到峰值温度 265°C。

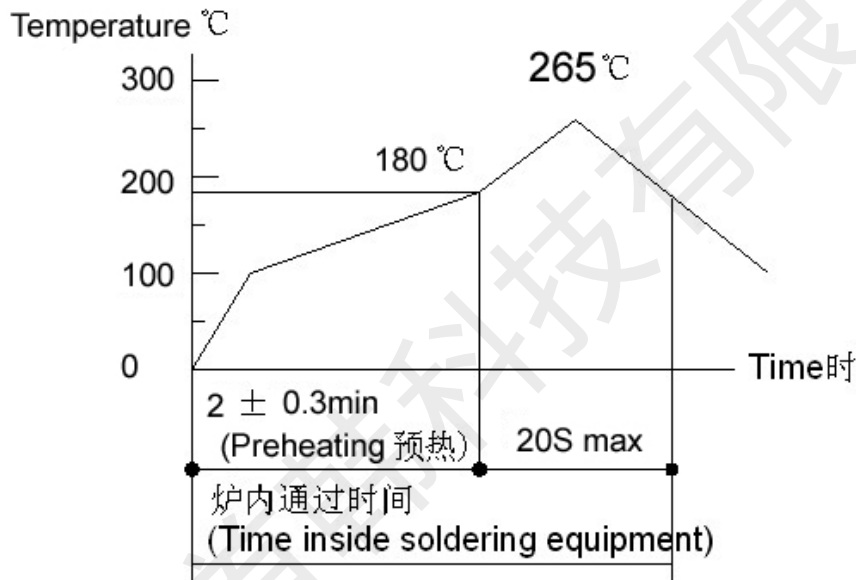

六、OTHER PRECAUTIONS 其他注意事项

- Following the soldering process, do not try to clean the switch with a solvent or the like .**
进行焊接过程中, 不可以用溶剂或类似品清洗开关。
- Safeguard the switch assembly against flux penetration from its topside.**
防止助焊剂从开关的顶端渗入。
- The product is ensured to keep in close status and kindly noted the storage time not exceed 90 days after delivery.**
交货后保证开关处于封密状态, 请注意库存时间不要超过 90 天以上。



TACT SWITCH SPECIFICATION

轻触开关产品规格书

File No.
文件编号

TS-B001-Y

Version
版本

A

七、SWITCH HANDLING PRECAUTION 使用开关时注意事项

1. In case an automatic flow soldering apparatus is use for soldering.
用自动焊接设备焊接时应参照如下条件

ITEM 项目	SOLDERING CONDITIONS 焊接条件
PREHEAT TEMPERATURE 预热温度	180°C MAX (AMBIENT TEMPERATURE OF PRINTED CIRCUIT BOARD ON ITS SOLDERING SIDE) (电路板周围焊锡面的温度)
PREHEAT TIME 预热时间	45 SEC MAX 45 秒 MAX
FLUX FOAMING 助焊剂浸泡	TO SUCH AN EXTENT THAT FLUX WILL BE KEPT FLUSH WITH THE PRINTED CIRCUIT BOARDS, TOP SURFACE ON WHICH COMPONENTS ARE MOUNTED. PRDPARATORY FLUX MUST NOT BE APPLIED TO THAT SODE OF PRINTED CIRCUIT BOARD ON WHICH COMPONENTS ARE MOUNTED AND TO THE AREA WHIERE TERMINALS ARE LOCATED. 助焊剂应涂在电路板上组装开关的印刷面上半部位, 应防止助焊剂过量到电路板.
SOLDERIN TEMPERATURE 焊锡温度	265°C MAX 265°C MAX
DURATION OF SOLDER IMMERSION 焊接时间	5 SEC MAX 5 秒 MAX
ALLOWABLE PREQUENCY 允许重焊次数	2 TIMES MAX 2 次 MAX

2. Other precautions 其他注意事项

- (1) FOLLOWING THE SOLDERING PROCESS, DO NOT TRY TO CLEAN THE SWITCH SOLVENT OR THE LIKE.
进行焊接工艺时不应使用不整洁的东西对开关进行清洁。
- (2) SAFEGUARD THE SWITCH ASSEMBLY AGAINST FLUX PENETRA TION FROM ITS TOP SIDE.
在组装开关时应防止助焊剂从开关的上部流入到开关内部。

TS-B001-Y

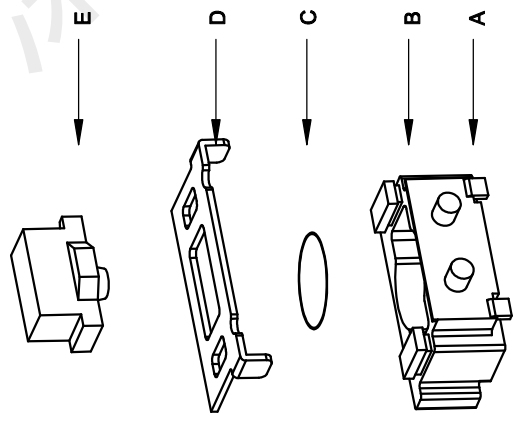

H
3.5
3.8

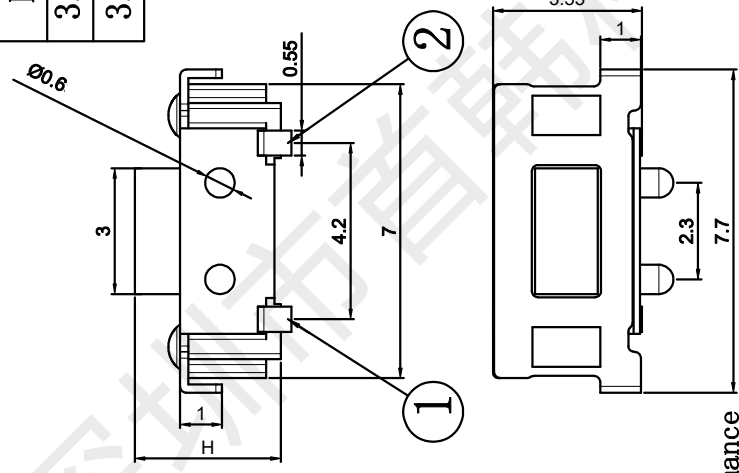

电路图

CIRCUIT DIAGRAM

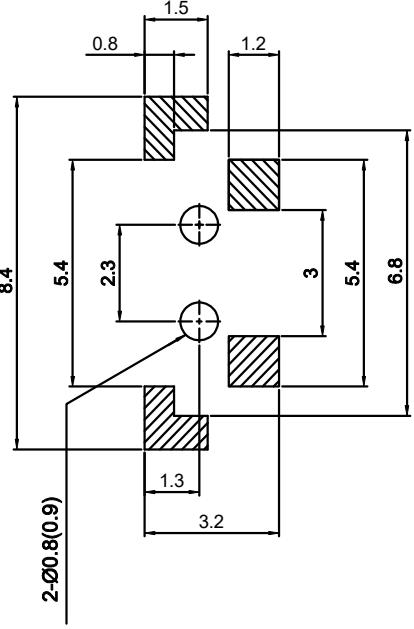
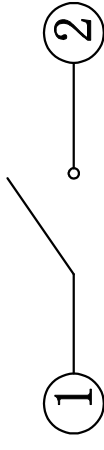

PCB. 焊接图

PCB. WELDING DRAWING

主要技术参数、性能

The Main Technology Performance

额定电流、电压 Rate voltage, current	50mA DC12V
接触电阻 Contact resistance	≤100mΩ
按力 Operating force	260±50gf
行程 travel	0.20±0.10mm
绝缘电阻 Insulated resistance	≥100MΩ
介电强度 Dielectric strength	≥250VAC/1min
寿命 Endurance	≥20000次

第一视角
FIRST VIEW



名称/NAME:
轻触开关
TACTILE SWITCH

型号/MODEL:
TS36CA-0.6 250gf 031

数量
QTY

表面处理/颜色
FINISH/COLOR

E	按钮	PPA	1	黑色
D	盖板	黄铜	1	镀银
C	弹片	不锈钢	1	镀银
B	本体	LCP	1	白色
A	卡件	黄铜	1	镀银
项目 ITEM	名称 DESCRIPTION	材质 MATERIAL	数量 QTY	表面处理/颜色 FINISH/COLOR

标记 SIGN	次数 FREQUENCY	更改文件号 REVISION	签名 APPROVED	日期 DATE	比例 SCALE	公差 GENERAL TOLERANCE
设计 DESIGN	李春风	2020.11.13	2020.11.13	1:1	0.5~2	±0.10
审核 CHECKED	钟华华	2020.11.13	2020.11.13	mm	2~5	±0.25
批准 APPROVED	罗孝金	2020.11.13	2020.11.13		5~10	±0.30
						角度 ANGLE
						±0.5°



深圳市首韩科技
有限公司

X-ON Electronics

Largest Supplier of Electrical and Electronic Components

Click to view similar products for [Tactile Switches](#) category:

Click to view products by [SHOU](#) manufacturer:

Other Similar products are found below :

[5GTH92001](#) [5GTH9202242](#) [6407-250V-25273P](#) [ADTSA62NV](#) [ADTSA62RV](#) [B3F-3123](#) [1977177-8](#) [1977266-1](#) [ADTSA63NV](#)
[ADTSM21NSVTR](#) [ADTSM25RVTR](#) [ADTSM32NVTR](#) [ADTSMW64RV](#) [FSMRA4JHA04](#) [GS4.70F300QP](#) [KSC241J SP DELTA LFS](#)
[3FTL600RAS](#) [3FTL640RAS](#) [Y96K132V0FPLFS](#) [5GTH9658222](#) [ADTSM31NVTR](#) [EVQ-P1D05K](#) [2-1977120-7](#) [TSJW-5.2-260-TR](#)
[KMT011MNGJLHS](#) [ADTSG648NV](#) [ADTSM62KSVTR](#) [ADTSM648NV](#) [95C06E3RAT](#) [5GTH96561](#) [3ATH9Q](#) [FSM4JSMLXTR](#)
[FSM4JSMXL](#) [FSMRA8JHA04](#) [HARS0073](#) [Y97HS12A5RAFP](#) [Y97BT23B2HAFP](#) [Y33R411N9FPLFT](#) [Y31C01402FPLFS](#)
[PTS645SK50SMTR92](#) [ADTSM32NVB](#) [KMS233GPWTLFG](#) [Y78B42324FP](#) [Y33R21116FPLFT](#) [Y31B43131FPLFG](#) [Y78B64124FP](#)
[Y71243251FP](#) [Y33R31119FPLFT](#) [Y97HS12A5TAFP](#) [PTS638SK25SMTR2LFS](#)