



深圳市首韩科技有限公司

SHENZHEN SHOUHAN TECHNOLOGY CO.,LTD

Tel: 0755-27597601

Fax: 0755-27597491

承认书

名称规格: TS3735PA(160gf/250gf/300gf)

客户料号:

工程部印章 刘小军	客户确认
------------------	------



SPECIFICATION

Page

1/8

Version

A/0

MODEL

Date

2016.06.06

1、概述

GENERAL

1.1 适用范围

APPLICATION

此规格书适用于机械式轻触开关的相关要求

This specification is applied to the requirements for TACTILE SWITCH (MECHANICAL CONTACT)

1.2 工作温度范围

Operating Temperature Range

-20℃~70℃ (在标准大气压、标准湿度条件下)

-20℃~70℃ (Normal humidity, normal air pressure)

1.3 贮藏温度范围

Storage Temperature Range

-30℃~80℃ (在标准大气压、标准湿度条件下)

-30℃~80℃ (Normal humidity, normal air pressure)

1.4 测试条件

Test Conditions

在没有其它特定的条件下，应该在以下的条件下进行测试和测量：

Unless otherwise specified, tests and measurement shall be made in the following standard conditions:

常温.....5℃~35℃

Normal temperature.....5℃~35℃

标准湿度.....相对湿度25%~85%

Normal humidity.....relative humidity 25%~85%

标准大气压.....86KPa~106Kpa

Normal air pressure.....86Kpa~106Kpa

在制造过程中，测试和测量应该在以下的条件下进行：

If any doubt arise from the judgment, tests shall be conducted at the following conditions:

温度.....20℃±2℃

Temperature.....20℃±2℃

相对湿度.....65%±5%

Relative humidity.....65%±5%

环境气压.....86KPa~106Kpa

Air pressure.....86KPa~106Kpa

	<h1>SPECIFICATION</h1>		Page	2/8
			Version	A/0
	MODEL		Date	2016.06.06
<p>2、 详细说明</p> <p>Detailed specification</p> <p>2.1 外观：应无影响、降低产品性能的缺陷；</p> <p>Appearance: There should be no defects that affect the serviceability of product.</p> <p>2.2 结构尺寸和安装尺寸：应符合装配图要求</p> <p>Style and dimension: shall conform to the assemble drawings.</p> <p>2.3 操作形式：有触觉反应的操作</p> <p>Type of actuating: Tactile feedback.</p> <p>2.4 开关结构：单回路单输出(具体的触点结构在装配图中已绘出)；</p> <p>Contact arrangement: 1 pole, 1 throw</p> <p>(Details of contact arrangement are given in the assembly drawings.)</p> <p>2.5 开关工作额定值：DC 12V, 50mA (有效值)</p> <p>Ratings: 12V DC, 50mA (effective value)</p> <p>3、 电气性能：</p> <p>ELECTRICAL SPECIFICATION</p>				
NO.	项目 ITEM	试验条件 TEST CONDITIONS	要求 REQUIREMENTS	
3.1	接触电阻 Contact Resistance	在以 5V 10mA的直流电源或不低于1KHz的交流电源的电路中，以一个等于2倍按力的静负荷施加于手柄中心 Applying a static load of 2 times operating force to the center of the stem, measurements shall be made by 5V DC 10mA or more than 1KHZ AC small-current contact resistance meter.	$\leq 200\text{m}\Omega$	
3.2	绝缘电阻 Insulation Resistance	在端子之间施加DC 100V /1min的条件下，测量端子之间底座、盖板的电阻值 Measurement shall be made following application of 100V DC potential, across terminals, and across terminals and cover, for one minute.	$\geq 100\text{M}\Omega$	
3.3	介质耐压 Dielectric voltage proof	在端子之间施加250V AC (50HZ或60HZ)/1min 250V AC (50HZ or 60HZ) shall be applied across terminals, for one minute.	无击穿、无飞弧 There should be no breakdown and flashover	

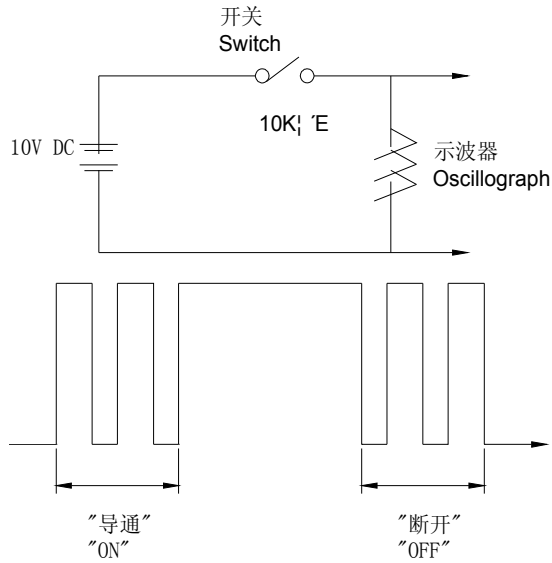
		<h1 style="text-align: center;">SPECIFICATION</h1>		Page	3/8
				Version	A/0
MODEL				Date	2016.06.06
NO.	项目 ITEM	试验条件 TEST CONDITIONS		要求 REQUIREMENTS	
3.4	触点抖动Bounce	<p>按照正常使用时的力度轻按手柄中心（每秒3~4次）， 在导通和断开过程中测试开关抖动 Lightly striking the center of the stem at a rate encountered in normal use (3 to 4 times per second), and bounce shall be tested at "ON" and "OFF"</p> 		ON-3msec. max OFF-8msec. max	
4、机械性能： MECHANICAL SPECIFICATION					
4.1	按力 Operating Force	<p>开关垂直于操作方向放置，在开关驱动件顶端中心逐渐施力，测量开关导通所需的最大力度 Placing the switch such that the direction of switch operation is vertical and then gradually increasing the load applied to the center of the stem, the maximum load required for the switch to come to a stop shall be measured</p>		3种按力选择：160/250/300 ± 50gf Operating Force: 160/250/300±50gf	
4.2	最大行程 Full Travel	<p>开关垂直于操作方向放置，以一个等于2倍按力的静负荷施加在开关驱动件顶端中心，测量顶端移动的距离。 Placing the switch such that the direction of switch operation is vertical and then applying static load of 2times operating force to the center of the stem; the travel distance for the switch to come to a stop shall be measured.</p>		0.2±0.1mm	

		SPECIFICATION		Page	4/8
				Version	A/0
		MODEL			Date
NO.	项目 ITEM	试验条件 TEST CONDITIONS	要求 REQUIREMENTS		
4.3	回弹力 Return Force	<p>开关垂直于操作方向放置，在开关驱动件顶端中心下降至全行程后，测量顶端向自由位置转换的力度。</p> <p>The sample switch is installed such that the direction of switch operation is vertical and upon depressing the stem in its center to the whole travel distance, the force of the stem to return to its free position shall be measured.</p>	回弹力 Return Force:50gf min		
4.4	停止强度 Stop Strength	<p>开关垂直于操作方向放置，从操作方向向驱动件施加20N的静负荷持续1min。</p> <p>Placing the switch such that the direction of switch operation is vertical, and then a static load of 20N shall be applied in the direction of stem operation for a period of 1 min.</p>	/		
4.5	手柄拔出强度 Stem Strength	<p>开关垂直于操作方向放置，反方向实施最大操作力，并测量手柄的行程范围。</p> <p>Placing the switch such that the direction of switch operation is vertical, and then the maximum force to withstand a pull applied opposite to the direction of stem operation shall be measured.</p>	/		
4.6	可焊性Solderability	<p>在以下设定条件下进行测量： Measurements shall be made following the test set forth below: (1) 焊接温度:245±5℃ Solder temperature : 245±5℃ (2) 浸入时间:2s±0.5s Immersion time: 2s±0.5s 对于其它步骤参考《GB 5095.6—86》试验12a The other steps please refer to《GB 5095.6—86》TEST 12a</p>	除边缘外涂层应均匀覆盖90%以上 Except for the edge, the coating should cover a minimum 90%		

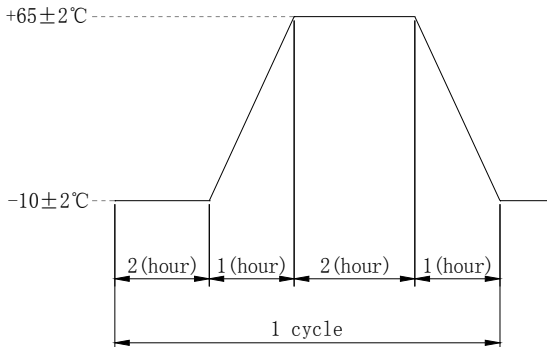
	<h1>SPECIFICATION</h1>		Page	5/8
			Version	A/0
	MODEL		Date	2016.06.06
5、 极限电气性能: ENVIRONMENTAL SPECIFICATION				
NO.	项目 ITEM	试验条件 TEST CONDITIONS	要求 REQUIREMENTS	
5.1	低温测试 Resistance to low temperature	样品应按照以下实验条件进行测试，实验后样品应放在常温及标准湿度的环境中1小时后做性能测试： Following the test set forth below the sample shall be left in normal temperature and humidity conditions for 1 h before measurements are made: (1) 温度: $-30\pm 2^{\circ}\text{C}$ Temperature : $-30\pm 2^{\circ}\text{C}$ (2) 时间: 96h Time: 96h		
5.2	高温测试 Heat resistance	样品应按照以下实验条件进行测试，实验后样品应放在常温及标准湿度的环境中1小时后做性能测试：Following the test set forth below the sample shall be left in normal temperature and humidity conditions for 1 h before measurements are made: (1) 温度: $80\pm 2^{\circ}\text{C}$ temperature: $80\pm 2^{\circ}\text{C}$ (2) 时间: 96h time: 96h	接触电阻: $\leq 200\text{m}\Omega$ Contact resistance: $\leq 200\text{m}\Omega$ 项目3, 4.1, 4.2, 4.3 Item 3, 4.1, 4.2, 4.3	
5.3	温度周期性测试 Change of temperature	根据下面的测试要求进行5次循环的温度周期性测试，实验后样品应放在常温及标准湿度的环境中1小时后做性能测试。测试期间样品应保持干燥。 After 5 cycles of following conditions, the sample shall be allowed to stand under normal temperature and humidity conditions for 1 h. and measurements shall be made. During the test water drops shall be removed. 		

		SPECIFICATION		Page	6/8	
				Version	A/0	
		MODEL			Date	2016. 06. 06
NO.	项目 ITEM	试验条件 TEST CONDITIONS		要求 REQUIREMENTS		
5.4	湿温测试 Moisture resistance	样品应按照以下实验条件进行测试，实验后样品应放在常温及标准湿度的环境中1小时后做性能测试：Following the test set forth below the sample shall be left in normal temperature and humidity conditions for 1 h before measurements are made: (1) 温度：60±2℃ temperature: 60±2℃ (2) 相对湿度：90%~95% relative humidity:90% to 95% (3) 时间：96h time: 96h		接触电阻：≤200mΩ Contact resistance: ≤200mΩ 项目3, 4. 1, 4. 2, 4. 3 Item 3, 4. 1, 4. 2, 4. 3		
5.5	硫化试验 Sulfuration resistance	样品应按照以下实验条件进行测试，实验后样品应放在常温及标准湿度的环境中1小时后做性能测试：Following the test set forth below the sample shall be left in normal temperature and humidity conditions for 1 h before measurements are made: (1) H2S气体浓度：3ppm±1ppm H2S gas concentration: 3ppm±1ppm (2) 时间：72h Time: 72h (3) 温度：40±2℃ (90~95%RH) temperature: 40±2℃ (90~95%RH)				
5.6	盐雾试验 Salt Mist	在以下设定条件下进行测量： The switch shall be checked after following test: (1) 温度：35℃±2℃ temperature: 35℃±2℃ (2) 盐溶液浓度：5±1% (质量百分比) salt solution : 5±1%(solids by mass) (3) 时间：8h±1h Time: 8h±1 hour 实验后的盐沉积物后水冲掉 After test, salt deposit shall be removed by running water.		金属件上没有腐蚀斑点 No remarkable corrosion shall be recognized in metal part.		

	<h1>SPECIFICATION</h1>		Page	7/8
			Version	A/0
	MODEL		Date	2016.06.06
6、 极限机械性能： ENDURANCE SPECIFICATION				
NO.	项目 ITEM	试验条件 TEST CONDITIONS	要求 REQUIREMENTS	
6.1	工作寿命 Operation life	根据下面的测试要求进行测试： Measurement shall be made following the test set forth below: (1) DC 12V, 50mA带负载 DC 12V, 50 mA resistive load (2) 按动速率：2次/秒 Rate of operation: 2 times/s (3) 按力：200g/300g/350g Operating Force: 200g/300g/350g (4) 平均无故障寿命：Average fault-free life:50000次	接触电阻 $\leq 500m\Omega$ Contact resistance $\leq 500m\Omega$ 触点弹力 $\leq 10ms$ Contact bounce $\leq 10ms$ 按力：初值的 $\pm 30\%$ Operating Force: initial value $\pm 30\%$ 项目3, 4.1, 4.2, 4.3 Item 3, 4.1, 4.2, 4.3	
6.2	振动Vibration	根据以下给定条件进行测试： Measurement shall be made following the test set forth below: (1) 振动频率范围：10~55~10Hz Vibration frequency range: 10 to 55 to 10Hz (2) 振幅（峰—峰）：1.5mm Amplitude: 1.5mm (3) 振动方向：包括手柄行程方向在内的三个相互垂直的方向 Direction of vibration: Three mutually perpendicular direction including the direction of stem travel (4) 测试时间：每次2hours . Duration: Each 2hours.	项目3, 4.1, 4.2, 4.3 Item 3, 4.1, 4.2, 4.3	
7、 焊接条件： SOLDERING CONDITIONS:				
7.1	手工焊接 Hand soldering	请按以下条件进行焊接： (1) 焊锡温度： $\leq 350^{\circ}C$ (2) 连续焊接时间： $\leq 3 s$ Please practice according to below conditions: (1) Soldering temperature: $350^{\circ}C$ Max. (2) Continuous soldering time: 3 s Max.		



SPECIFICATION

Page

8/8

Version

A/0

MODEL

Date

2016.06.06

NO.

项目
ITEM

条件
CONDITIONS

7.2

自动焊接
Automatic soldering

在使用的情况下自动焊接

In case the automatic flow soldering is to be used

(1) 预热 ----- 150°C ~ 175°C, 40 ~ 80 sec

Preheat ----- 150°C ~ 175°C, 40 ~ 80 sec

(2) 峰值温度----- 260°C (max)

Peak temperature ----- 260°C (max)

(3) 焊接区温度----- 260°C, 1 ~ 4 sec, 2 times (max)

Soldering area temperature ----- 260°C, 1 ~ 4 sec, 2 times (max)

(4) 高温后性能衰变值±20%

After high temperature, the decay data about performance will be ±20%

T:°C

280

260°C max

240°C

210

170°C

140

140°C

70

0

Time:S

5-6minute

< Temperature profile >

8、 Other precautions其他注意事项

8.1 印刷基板的安装孔尺寸参见产品图。

Follow recommended P.W.B. piercing plan in outside drawing page.

8.2 注意不要施加超负荷的压力或晃动开关。

Please be cautions not to give excessive static load or shock to swiches.

8.3 进行焊接过程中，不可以用溶剂或类似品清洗开关

Following the soldering process, do not try to clean the switch with a solvent or the like.

8.4 防止助焊剂从开关的顶端渗入

Safeguard the switch assembly against flux penetration from its topside.

8.5 保管时尤其应注意避开高湿高温和有腐蚀性气体的环境。如需要长时间保存，请不要打开包装箱。

Preservation under high temperature and high high humidity or corrosive gas should be avoided Especially . When you need to preserve for a long period ,do not open the carton.

1	2	3	4
RevNo	Revision note	Date	Signature
			Checked

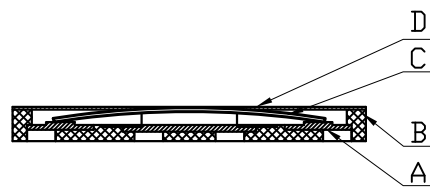
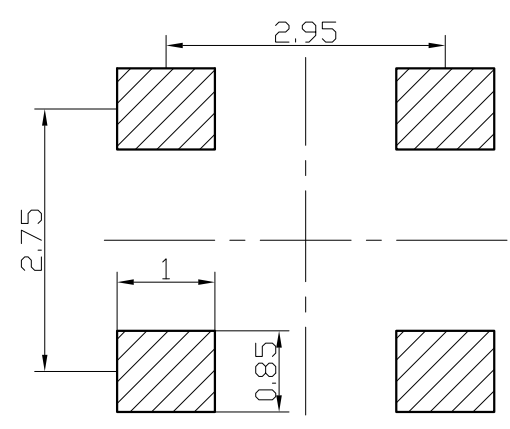
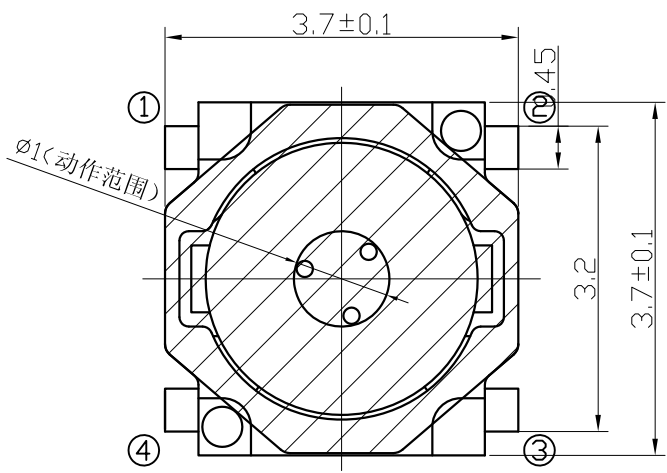
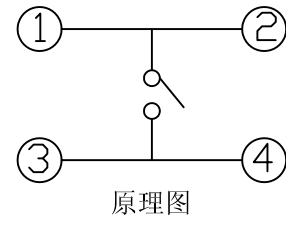
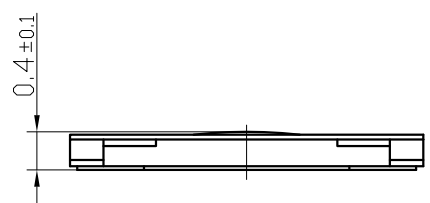

技术要求:

1. 零部件表面光洁无划伤，水花，变形，影响外观及性能等缺陷。
2. 额定电流：50mA. 12V DC, 绝缘电阻100MΩmin, 100V DC, 介电强度250V AC for 1min, 接触电阻200mΩ max 。260° 高温后衰变值在初始值的20%内；
3. 开关手感明显，档位清晰可靠，无卡滞现象，消除外力后，应能快速回位。

D	防尘膜	2RF2	0.05	1	
C	簧片	2TE3/YE2	进口不锈钢覆银	1	
B	底座	2TB1	LCP黑	1	
A	卡件	2TA2	磷铜0.05	1	
序号	名称	图号	材料	数量	备注

				材料	角度公差	比例	名稱	3.7X3.7*0.35轻触（直脚）
					±1°	1:1		
				電鍍顏色	標尺公差	單位	型號	TS3735PA 160/250/300gf
					±0.01	mm		
				厚度	日期	版本	料號	成品外形图
標記	處數	更改文件號	簽字	日期				
設計		標準化		審核	批准		深圳市首韩科技有限公司	
1							4	

X-ON Electronics

Largest Supplier of Electrical and Electronic Components

Click to view similar products for [Tactile Switches](#) category:

Click to view products by [SHOU](#) manufacturer:

Other Similar products are found below :

[5GTH92001](#) [5GTH9202242](#) [6407-250V-25273P](#) [ADTSA62NV](#) [ADTSA62RV](#) [B3F-3123](#) [1977177-8](#) [1977266-1](#) [ADTSA63NV](#)
[ADTSM21NSVTR](#) [ADTSM25RVTR](#) [ADTSM32NVTR](#) [ADTSMW64RV](#) [FSMRA4JHA04](#) [GS4.70F300QP](#) [KSC241J SP DELTA LFS](#)
[3FTL600RAS](#) [3FTL640RAS](#) [Y96K132V0FPLFS](#) [5GTH9658222](#) [6407-250V-25343P](#) [ADTSM31NVTR](#) [EVQ-P1D05K](#) [2-1977120-7](#) [TSJW-](#)
[5.2-260-TR](#) [KMT011MNGJLHS](#) [B3WN6002S](#) [70-201.0](#) [ADTSG648NV](#) [ADTSM62KSVTR](#) [ADTSM648NV](#) [95C06E3RAT](#) [5GTH96561](#)
[3ATH9Q](#) [FSMRA8JHA04](#) [HARS0073](#) [Y97HS12A5RAFP](#) [Y97BT23B2HAFP](#) [Y33R411N9FPLFT](#) [Y31C01402FPLFS](#)
[PTS645SK50SMTR92](#) [ADTSM32NVB](#) [KMS233GPWTLFG](#) [Y78B64124FP](#) [PTS638SK25SMTR2LFS](#) [Y96D113G0FP LFS](#) [Y33A812C5FP](#)
[LFT](#) [Y56B2D120FP LFS](#) [PTS645 DVM83-BN125-2 LFS](#) [B3W 1000G](#)