

8
7
6
5
4
3
2
1

VER	MARK	PR. BY	ECR/ECN	DESCRIPTION	DATE
A				NEW RELEASE	09/11' 21
B	△			新增规格 △ *3	12/15' 21
C	△			新增规格 △ *1	01/03' 22
D	△			新增规格 △ *1	02/17' 22

SPECIFICATION:

- MATERIAL & FINISH: SEE THE LIST;
- PLATING SPECIFICATION:
 - CONTACTS:
 - Ni 50u" MIN. UNDER PLATED OVER ALL.
 - Au PLATED ON THE MATING AREA OF CONTACT.
 - Sn PLATED ON THE SOLDER AREA.
 - SHELL: Ni 30u" MIN. UNDER PLATED OVER ALL.
 - MID PLATE: CLEAR ONLY
- MECHANICAL:
 - MATING FORCE: 0.5~2.0kgf;
 - UNMATING FORCE: 0.8~2.0kgf.
 - DURABILITY: 10000 CYCLES;
- ELECTRICAL:
 - CURRENT RATING: 5A Max;
 - VOLTAGE RATING: 20V Max;
 - DIELECTRIC WITHSTANDING VOLTAGE: 100Vac;
 - CONTACT RESISTANCE: 40mΩ Ohms Max.;
 - INSULATION RESISTANCE: 100M Ohms Min.;
- ENVIRONMENTAL:
 - OPERATING TEMPERATURE: -40° C~+85° C;
 - WETTING TEMPERATURE: 265±5° C, 5±0.5s
 - Salt Spray Test: 48H Min

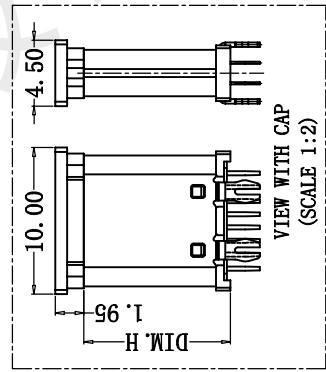
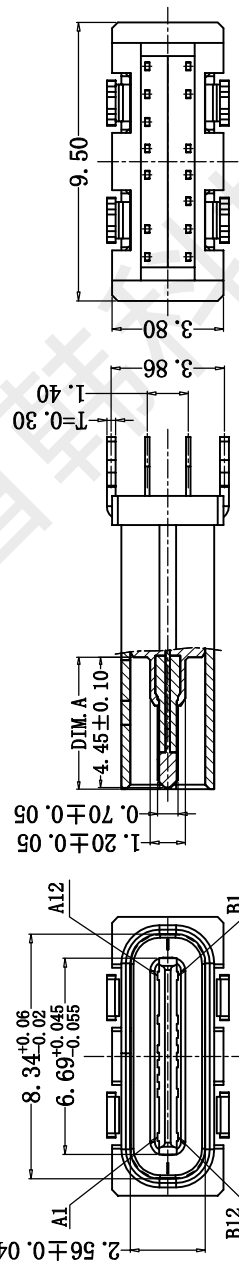
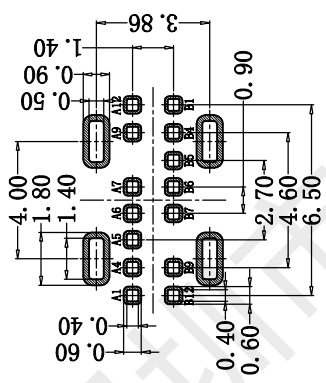
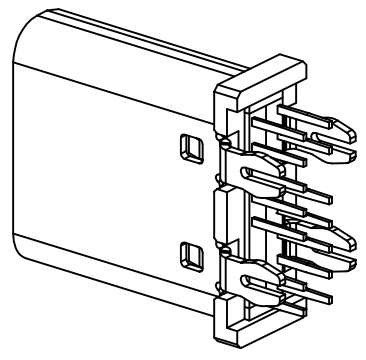

PIN DEFINE TABLE	
PIN SIGNAL	PIN SIGNAL
A12 GND	B1 GND
A11	B2
A10	B3
A9 VBUS	B4 VBUS
A8	B5 CC2
A7 D-	B6 D+
A6 D+	B7 D-
A5 CC1	B8
A4 VBUS	B9 VBUS
A3	B10
A2	B11
A1 GND	B12 GND

NO.	镀金1u"	镀金3u"	DIM. H	DIM. A
1	1014-FGB017	1014-FRB016	10.0	4.50
2	1014-FGB018	1014-FRB016	10.5	5.00
3	1014-FGB005		10.0	4.50
4	1014-FGB001		10.5	5.00
5	1014-FGB006		10.5	5.00
6	1014-FGB001		10.0	4.50
7	1014-FGB002		10.0	4.50

NO.	PART NAME	Q' TY	MATERIAL	FINISH
4	Shell	1	Stainless Steel, T=0.30mm	30u"Ni Min.
3	GroundBar	1	Stainless Steel, T=0.15mm	No Plating
2	Contact	14	Copper Alloy, T=0.15mm	Au/Sn/Ni-Plated
1	Housing	1	High temperature plastic	UL94 V-0, Black

CUSTOMER		GENERAL TOLERANCES	
SIZE	UNITS	UNLESS SPECIFIED	APPROVED BY:
A4	MM[INCH]	X'±5.0'	罗孝金
SCALE	REV.	.X'±3.0'	CHECKED BY:
1:1	D	.XX±2.5'	钟德华
		.XXX±2.0'	DESIGN BY:
			李春风

TITLE:		TYPC-14PLC-H10.0
PART NO.:		See the List
DWG NO.:		1014-FXXXXX
SHEET		1/1

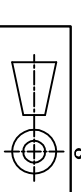

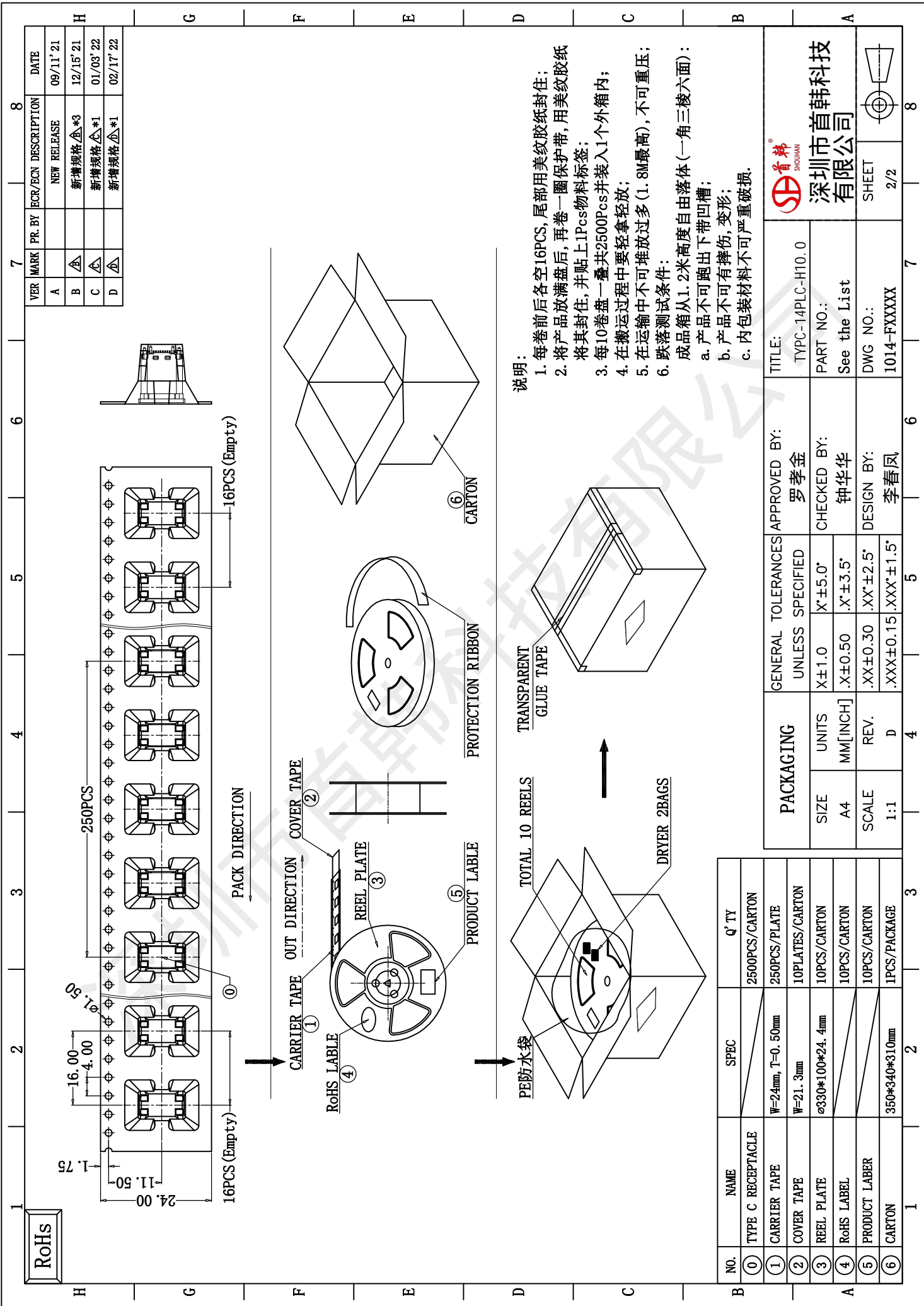

说明:

1. 每卷前后各空16PCS, 尾部用美纹胶纸封住;
2. 将产品放满盘后, 再卷一圈保护带, 用美纹胶纸将其封住, 并贴上1Pcs物料标签;
3. 每10卷盘一叠共2500Pcs并装入1个外箱内;
4. 在搬运过程中要轻拿轻放;
5. 在运输中不可堆放过多(1.8M最高), 不可重压;
6. 跌落测试条件:
成品箱从1.2米高度自由落体(一角三棱六面):
a. 产品不可跑出下带凹槽;
b. 产品不可有摔伤, 变形;
c. 内包装材料不可严重破损.

NO.	NAME	SPCC	Q' TY
①	TYPE C RECEPTACLE		2500PCS/CARTON
②	CARRIER TAPE	W=24mm, T=0.50mm	250PCS/PLATE
③	COVER TAPE	W=21.3mm	10PLATES/CARTON
④	REEL PLATE	φ330*100*24.4mm	10PCS/CARTON
⑤	RoHS LABEL		10PCS/CARTON
⑥	PRODUCT LABELER		10PCS/CARTON
	CARTON	350*340*310mm	1PCS/PACKAGE

PACKAGING		GENERAL TOLERANCES UNLESS SPECIFIED	APPROVED BY:
SIZE	UNITS	X \pm 1.0	罗孝金
A4	MM[INCH]	.X \pm 0.50	CHECKED BY:
SCALE	REV.	.XX \pm 0.30	钟德华
1:1	D	.XXX \pm 0.15	DESIGN BY:
		.XXX \pm 1.5*	李春风

TITLE:	TYPC-14PLC-H10.0
PART NO.:	See the List
DWG NO.:	1014-FXXXXX

深圳市首韩科技
有限公司

SHEET 2/2

VER	MARK	PR. BY	ECR/ECN	DESCRIPTION	DATE
A				NEW RELEASE	09/11'21
B	△			新增规格△*3	12/15'21
C	△			新增规格△*1	01/03'22
D	△			新增规格△*1	02/11'22



深圳市首韩科技有限公司

SHENZHEN SHOUHAN TECHNOLOGY CO., LTD

Tel: 0755-27597601 Fax: 0755-27597491

承 认 书

SPECIFICATION FOR APPROVAL

客 户 Customer:

产品名称 Project:

TYPE-C

规格型号 Part No:

TYPE-C 14PLC-H10.0

贵公司承认印 Approval signatures

料 号/Part No.	签 章/Signatures

日期 Date:

拟制/Drawn	李春风	
审核/Check	钟华华	
批准/Approved	罗孝金	



RATING (额定值):		DC 20V	5A
PRACTICAL TEMPERATURE RANGE 使用温度范围	-40~85° C 在-40° C~+85° C 温度内使用		
STANDARD ATMOSPHEIC CONDITIONS 测试标准状况	UNLESS OTHERWISE SPECIFIED THE STANDARD RANGE OF ATMOSPHERIC CONDITIONS FOR MAKING MEASUREMENTS AND TESTS ARE AS FOLLOWS: (1) BETWEEN BODY AND CONDUCTOR: 5° C TO 35° C (2) BETWEEN CONDUCTORS NOT TO BE CONTACT: 45% TO 85% (3) PRESSURE: 86Kpa TO 106Kpa 在没有指定的情况下测试温度、湿度、气压如下: (1) 温度为 5° C~35° C (2) 湿度为 45%~85% (3) 气压为 86 Kpa~106Kpa		
MECHANICAL (机械性能)			
ITEM 项目		TEST CONDITIONS 测试条件	PERFORMANCE 规格
1	CONNECTION FORCE 插入力度	MEASUREMENT SHALL BE MADE AFTER CONNECTING AND DISCONNECTING USING STANDARD PLUG GAUGE 3 TIMES. 依据标准的 PLUG GAUGE 做第 3 次拔插后测定	0.5-2.0Kgf
	DISCONNECTI ON FORCE 拔出力度	MEASUREMENT SHALL BE MADE AFTER CONNECTING AND DISCONNECTING USING STANDARD PLUG GAUGE 3 TIMES. 依据标准的 PLUG GAUGE 做第 3 次拔插后测定	0.8-2.0Kgf
2	TERMINAL STRENGTH 端子强度	A STATIC LOAD OF 0.1N/m(1kgf/cm)SHALL BE APPLIED TO THE TIP OF THE TERMINAL FOR 1 MIN IN ANY DIRECTION 向排脚先端的任意一个方向加 1 分钟 0.1N/m(1kgf/cm)的力度.	THERE SHALL BE NO DAMAGE TO THE TERMINAL SUCH AS CRACKS, LOOSENESS OR PLAY ELECTRICAL ,AND MECHANICAL CHARACTERISTICS SHALL BE SATISFIED 在排脚中没有裂开、松动等异常, 满足于机械、电气性能
ELECTRICAL (电气性能)			
ITEM 项目		TEST CONDITIONS 测试条件	PERFORMANCE 规格
3.1	CONTACT RESISTANCE 接触电阻	MEASURED AT SMALL CURRENT (100m A OR LESS) 1000Hz 在微小电流 (100 m A) 以下测试	40m Ω MAX
3.2	INSULATION RESISTANCE 绝缘电阻	APPLY A VOLTAGE OF 100V DC FOR 1 MIN TO FOLLOWING PORTIONS AFTER WHICH MEASUREMENT SHALL BE MADE: (1) BETWEEN BODY AND CONDUCTOR (2) BETWEEN CONDUCTORS NOT TO BE CONTACT (3) BETWEEN CONDUCTORS NOT TO BE WHEN PLUG IS INSERTED DC100V 1 MIN 输入 100V DC 电压 1 分钟, 按以下接触方法测试: (1) 插座体与排脚之间 (2) 不接触的排脚之间 (3) 插头插入时不接触排脚之间	100M Ω MIN

3.3	DIELECTRIC STRENGTH 耐电压	AC 100V 5ms(50~60Hz)FOR 1 MIN TRIP CURRENT:0.5mA (1) BETWEEN BODY AND CONDUCTOR (2) BETWEEN CONDUCTORS NOT TO BE CONTACT (3) BETWEEN CONDUCTORS NOT TO BE WHEN PLUG IS INSERTED DC 100V 1 MIN 输入 AC 100V (50Hz) /min 电压 1 分钟感度电流为 0.5mA, 按以下接触方法测试: (1) 插座体与排脚之间 (2) 不接触的排脚之间 (3) 插头插入时不接触排脚之间	WITHOUT DAMAGE TO PARTS ARCING OR BREAKDOWN ETC 没有绝缘破坏等异常
-----	-----------------------------------	---	--

URABILITY (耐久性)

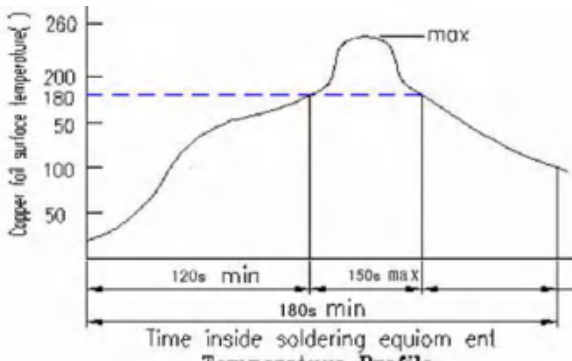
ITEM 项目	TEST CONDITIONS 测试条件	PERFORMANCE 规格
4. 1	SOLDERABILITY TEST 可焊性试验	THE TOP OF THE TERMINALS SHALL BE DIPPED 1mm IN THE SOLDER BATH OF 250±5°C FOR 5±0.5 SECONDS 端子顶部被浸入锡池中 1mm 深,温度为 250±5°C,时间为 5±0.5 秒 (1) SOLDER WETTING TIME SHALL BE 3 SEC OR LESS 焊接时间应少于 3 秒 (2) THE AREA OF SOLDERING SHOULD BE OVER 75% 焊接面积应有 75%以上
4.2	RESISTANCE TO SOLDERING HEAT TEST 耐焊性试验	REFLOW SOLDERING CONDITIONS: PREHEAT:TEMPERATURE ON THE COPPER FOIL SURFACE SHOULD REACH 180 .120S AFTER THE P.C.B ENTERED INTO THE SOLDERING EQUIPMENT. TALLEST TEMPERATURE:TEMPERATURE ON THE COPPER FOIL SURFACE SHOULD REACH THE PEAK TEMPERATURE OF 260±5 WITH IN 20 SECONDS. 过回流焊条件: 预热:电镀层表面的温度应达到 180°C,120s 后电路板进入回流焊设备。 最高温度:电镀层表面温度最高为 260±5°C且停留不超过 20 秒。  <p style="text-align: center;">Temperature Profile</p> WITHOUT DEFOR MATION OF CASE OR EXCESSIVE LOOSENESS OF TEMINALS ELECTRICAL CHARACTERISTICS SHALL BE SATISFIED 本体无变形, 满足于机械、电气性能

4. 2	<p>RESISTANCE TO SOLDERING HEAT TEST 耐焊性试验</p>	<p>SOLDERING IRON METHOD: BIT TEMPERATURE $330 \pm 5^{\circ}\text{C}$ APPLICATION TIME OF SOLDERING IRON $3 \pm 0.5 \text{ SEC}$ HOWEVER EXCESSIVE PRESSURE SHALL NOT BE APPLIED TO THE TERMINAL 手焊接的时候温度需控制在 $330 \pm 5^{\circ}\text{C}$, 时间为 3 ± 0.5 秒, 但不能在排脚上施加异常压力。</p>	<p>WITHOUT DEFORMATION OF CASE OR EXCESSIVE LOOSENESS OF TEMINALS ELECTRICAL CHARACTERISTICS SHALL BE SATISFIED 本体无变形, 满足于机械、电气性能</p>
4. 3	<p>HUMIDITY TEST 潮湿试验</p>	<p>THE JACK SHALL BE STORED AT A TEMPERATURE OF $40 \pm 2^{\circ}\text{C}$ AND A HUMIDITY OF 90% TO 96% FOR 96 Hr, THEN THE JACK SHALL BE MAINTAINED AT STANDARD ATMOSPHERIC CONDITION FOR 1 Hr FOR OTHER PROCEDURES 放置 $40 \pm 2^{\circ}\text{C}$ 的相应湿度为 90~96% Hr 环境中 96 小时后, 再将样板放在正常环境中 1 小时后进行测试</p>	<p>THERE SHALL BE NO DAMAGE ON APPEARANCE. MECHANICAL AND ELECTRICAL CHARACTERISTICS SHALL BE SATISFIED 外观无异常, 满足于机械、电气性能。</p>
4.4	<p>HEAT TEST 耐热试验</p>	<p>THE JACK SHALL BE STORED AT A TEMPERATURE OF $70 \pm 2^{\circ}\text{C}$ FOR 96 HOURS, AND THEN IT SHALL BE SUBJECTED TO THE CONTROLLED RECOVERY MBASURBM 放置在温度 $70 \pm 2^{\circ}\text{C}$ 中测试 96 小时后, 再放置正常室温中 1 小时来测定</p>	
4. 5	<p>COLD TEST 耐寒试验</p>	<p>THE JACK SHALL BE STORED AT A TEMPERATURE OF $-25 \pm 3^{\circ}\text{C}$ FOR 96 HOURS AND THEN IT SHALL BE SUBJECTED TO THE CONTROLLED RECOVERY CONDITIONS FOR 1 HOUR AFTER WHICH 放置在温度 $-25 \pm 3^{\circ}\text{C}$ 中 96 小时后, 再放置常温常湿中 1 小时来测定</p>	<p>THERE SHALL BE NO DAMAGE ON APPEARANCE MECHANICAL AND ELECTRICAL CHARACTERISTICS SHALL BE SATISFIED 外观无异常, 满足于机械、电气性能</p>
4. 6	<p>LIFE TEST 寿命试验</p>	<p>WITHOUT LOAD CONNECTION AND DISCONNECTION SHALL BE MADE WITH THE MATING PLUGS AND JACKS FOR 10000 CYCLES AT A SPEED OF 10 TO 25 CYCLES/MIN 无负荷 将结合了的标准 Plug (尽量要近于中心的) 在 1 分钟内以 10-25 的速度, 进行 10000 次插入, 拔出 LOAD: AT RATING CONDITION (NON-INDUCTIVE LOAD) CONNECTION AND DISCONNECTION SHALL BE MADE 10000 CYCLES AT A SPEED 10 TO 20 CYCLES / MIN 负荷 以定格状态(无诱导负荷)在 1 分钟内以 10-20 次的速度进行 10000 次插入、拔出</p>	<p>(1) CONTACT RESISTANCE SHALL BE $\leq 0.1 \Omega$ (2) DISCONNECTION FORCE SHALL BE 0.8 TO 2.0N (3) MECHANICAL AND ELECTRICAL CHARACTERISTICS SHALL BE SATISFIED (1) 接触电阻 $\leq 0.1 \Omega$ (2) 拔出力是 0.8~2.0N (3) 其它: 满足于机械、电气性能</p>

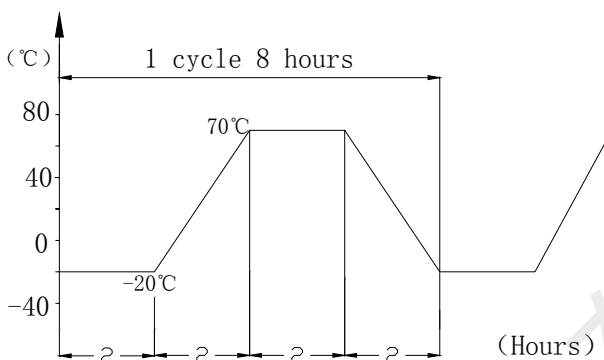
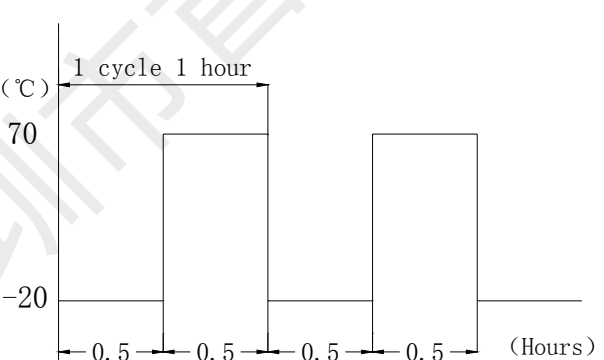
<p>4.7</p>	<p>TEMPERATURE CYCLING TEST 温度循环测试</p>	<p>THE JACK SHALL BE SUB JECTED TO 5 CYCLES OF THE FOLLOWING CONDITIONS SHOWN IN THE FIGURE,AND THEN SHALL RETURNED ALLOWED TO REMAIN IN ROOM AMBIENT CONDITION FOR 30 MINUTES 将插座以下列条件作 5 个循环，然后放回室内环境 30 分钟</p> <p>Temp(°C)</p> 	<p>THERE SHALL BE NO DEFORMATION OR CRACKS IN MOLDED PART. INSERTION & EXTRACTION FORCE:3 TO 20N CONTACT RESISTANCE:MAX.30M Ω INSULATION RESISTANCE: MIN.100 M Ω DIELECTRIC WITHSTANDING VOLTAGE: 100VAC/MIN(BETWEEN TERMINALS)</p> <p>产品不能变形与破裂 插拔力: 3N 至 20N 接触电阻: 最大 30m Ω 绝缘电阻: 最小 100 M Ω 绝缘耐压: 最小 100VAC (端子之间)</p>
<p>4.8</p>	<p>COLD&HEAT SHOCK TEST 冷热冲击测试</p>	<p>THE JACK SHALL BE SUBJECTED TO 5 CYCLES OF THE FOLLOWING CONDITIONS SHOWN IN THE FIGURE,AND THEN SHALL RETURNED AND ALLOWED TO REMAIN IN ROOM AMBIENT CONDITION FOR 30 MINUTES 将插座以下列条件作 5 个循环，然后放回室内环境 30 分钟</p> <p>TEMP (°C)</p> 	<p>THERE SHALL BE NO DEFORMATION OR CRACKS IN MOLDED PART. INSERTION & EXTRACTION FORCE:3 TO 25N CONTACT RESISTANCE:MAX.30M Ω INSULATION RESISTANCE: MIN.100 M Ω DIELECTRIC WITHSTANDING VOLTAGE: 500VAC/MIN(BETWEEN TERMINALS)</p> <p>产品不能变形与破裂 插拔力: 3N 至 25N 接触电阻: 最大 30m Ω 绝缘电阻: 最小 100 M Ω 绝缘耐压: 最小 500VAC (端子之间)</p>

X-ON Electronics

Largest Supplier of Electrical and Electronic Components

Click to view similar products for [USB Connectors](#) category:

Click to view products by [SHOU](#) manufacturer:

Other Similar products are found below :

[950](#) [A-USB A-LP-SMT-C](#) [A-USB B-TOP-C](#) [MUSBD11135](#) [17-200721](#) [217450-1](#) [KMBVX-TH-5S-B30](#) [KUSBX-AS2N-W](#) [KUSBX-SMT2AP1S-W30](#) [935](#) [957](#) [30-498-6](#) [SK-60A-2](#) [1734082-1](#) [30-470](#) [30-489](#) [30-541](#) [MAB 5 S](#) [A-USB A-2P-C](#) [MIKROE-1451](#)
[USBFTVSCCG](#) [4689-1](#) [1-1734084-2](#) [NK-27-32SL](#) [NK-L8-22C-5/8](#) [10135326-001LF](#) [4198](#) [690-024-633-031](#) [UB-20PMFP-LC7001](#) [17-200011](#) [UB-20AFMM-LL7A01](#) [CAP-WCCMLPB1](#) [CAP-WCCMLPC1](#) [2274475-3](#) [914-614A2025S10200](#) [USB3FTV7SAGF059](#)
[USB3FTV2SAZNF459](#) [USB3FTV7SAZNF459](#) [HYCW153-USBD05-500B](#) [HYCW219-USBD05-075B](#) [HYCW148-USBD05-117B](#)
[HYCW149-USBD05-740B](#) [HYCW204-USBD05-108B](#) [HYCW214-USBA04-113B](#) [HYCW213-USBA04-113B](#) [KMMX-BSMT35S-1-B30TR](#)
[2345986-1](#) [10082141-N340LF](#) [10117836-011LF](#) [GSB3C3133DSYHR](#)