

装前塞示意图

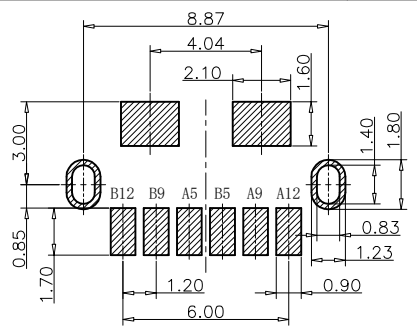

RECOMMEND P.C.B LAYOUT (COMPONENT SIDE)
TOLERANCE FOR PCB LAYOUT IS ± 0.05

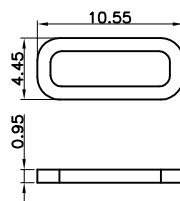
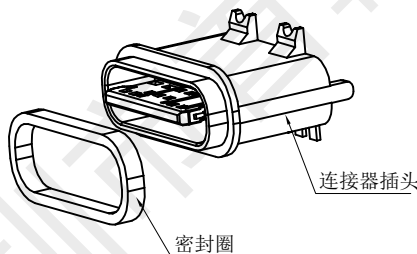
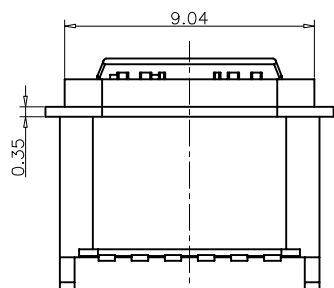
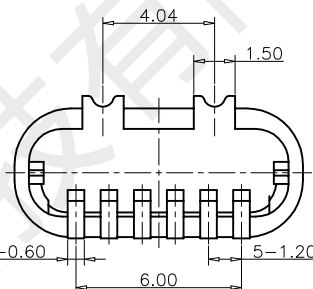
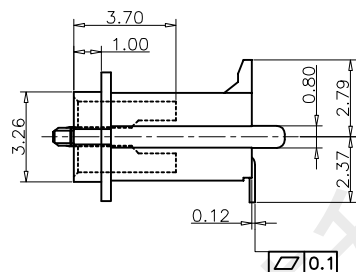
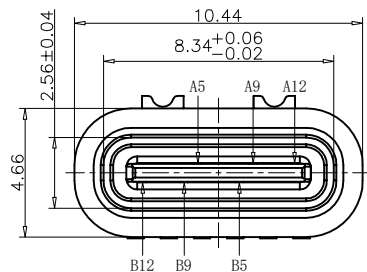

防水圈图

USB TYPE C PIN ASSIGNMENTS

| PIN NUMBER | SIGNAL NAME | PIN NUMBER | SIGNAL NAME |
|------------|-------------|------------|-------------|
| | | B12 | GND |
| | | B9 | VBUS |
| A5 | CC1 | | |
| A9 | VBUS | B5 | CC2 |
| A12 | GND | | |

备注 (NOTE):

1. 电气特性:

1. 接触区: 接触电阻 $40m\Omega$ Max, 允许 $10m\Omega$ 变化量. 测试条件: $20mv$, $100mA$ 下测量.
 1. 2. 接触电流: $3A$ VBUS 引脚; $1.25A$ 用于 GND 引脚; 其他引脚为 $0.25A$.
 1. 3. 额定电压: $5V$.
 1. 4. 耐电电压: $100VAC$.
 1. 5. 绝缘电阻: 至少 100 兆欧.
2. 机械性能:
3. 1. 插入力: $5-20N$
 3. 2. 拔出力: $6-20N$
 3. 3. 插拔次数: 5000 次.
 4. 工作环境: $-20^{\circ}C$ to $+85^{\circ}C$.

TABLE:

| NO | PART | Q'TY | Material |
|----|-------------|------|---|
| 1 | SHELL | 1 | ZINC ALLOY, NI PLATED |
| 2 | CONTACT | 6 | COPPER STEEL, TIN/Au/NI PLATED |
| 3 | 1MD HOUSING | 1 | HIGH TEMPERATURE RESISTANT PLASTIC BLACK UL94 V-0 |



深圳市首韩科技有限公司

品名 (ITEM NO) TYPE-C 6PFS LTH6.45 IPX8

料号 (PART NO) ATCF-06-008

图号 (DWG NO) TCF-014

页码 (SHEET)

版本 (REV) A0 单位 (UNIT): MM

日期 (DATE) 2021.08.25 比例 (SCALE) 1:1

设计 (DESIGN) 李春风 未注公差

审核 (CHECKED) 钟华华 TOLERANCE UNSPECIFIED

核准 (APPROVED) 罗孝金

X.X ± 0.20
X.XX ± 0.15
X.XXX ± 0.10
X° $\pm 5^{\circ}$
X.X° $\pm 2^{\circ}$



深圳市首韩科技有限公司

SHENZHEN SHOUHAN TECHNOLOGY CO., LTD

Tel: 0755-27597601 Fax: 0755-27597491

承 认 书
SPECIFICATION FOR APPROVAL

客 户 Customer:

产品名称 Project:

TYPE-C

规格型号 Part No:

6PFS LCH6.45 IPX8

贵公司承认印 Approval signatures

| 料 号/Part No. | 签 章/Signatures |
|--------------|----------------|
| | |

日期 Date:

| | | |
|-------------|-----|--|
| 拟制/Drawn | 李春风 |  |
| 审核/Check | 钟华华 | |
| 批准/Approved | 罗孝金 | |



| | | | |
|--|--|--|--|
| RATING (额定值): | | DC5V 3A | |
| PRACTICAL TEMPERATURE RANGE 使用温度范围 | -20~85° C 在-20° C~+85° C 温度内使用 | | |
| STANDARD ATMOSPHEIC CONDITIONS 测试标准状况 | UNLESS OTHERWISE SPECIFIED THE STANDARD RANGE OF ATMOSPHERIC CONDITIONS FOR MAKING MEASUREMENTS AND TESTS ARE AS FOLLOWS: (1) BETWEEN BODY AND CONDUCTOR: 5° C TO 35° C (2) BETWEEN CONDUCTORS NOT TO BE CONTACT: 45% TO 85% (3) PRESSURE: 86Kpa TO 106Kpa 在没有指定的情况下测试温度、湿度、气压如下: (1) 温度为 5° C~35° C (2) 湿度为 45%~85% (3) 气压为 86 Kpa~106Kpa | | |
| MECHANICAL (机械性能) | | | |
| ITEM 项目 | TEST CONDITIONS 测试条件 | PERFORMANCE 规格 | |
| 1 | CONNECTION FORCE 插入力度 | MEASUREMENT SHALL BE MADE AFTER CONNECTING AND DISCONNECTING USING STANDARD PLUG GAUGE 3 TIMES. 依据标准的 PLUG GAUGE 做第 3 次拔插后测定 | 5-20N |
| | DISCONNECTI ON FORCE 拔出力度 | MEASUREMENT SHALL BE MADE AFTER CONNECTING AND DISCONNECTING USING STANDARD PLUG GAUGE 3 TIMES. 依据标准的 PLUG GAUGE 做第 3 次拔插后测定 | 6-20N |
| 2 | TERMINAL STRENGTH 端子强度 | A STATIC LOAD OF 0.1N/m(1kgf/cm)SHALL BE APPLIED TO THE TIP OF THE TERMINAL FOR 1 MIN IN ANY DIRECTION 向排脚先端的任意一个方向加 1 分钟 0.1N/m(1kgf/cm)的力度. | THERE SHALL BE NO DAMAGE TO THE TERMINAL SUCH AS CRACKS, LOOSENESS OR PLAY ELECTRICAL ,AND MECHANICAL CHARACTERISTICS SHALL BE SATISFIED 在排脚中没有裂开、松动等异常, 满足于机械、电气性能 |
| ELECTRICAL (电气性能) | | | |
| ITEM 项目 | TEST CONDITIONS 测试条件 | PERFORMANCE 规格 | |
| 3.1 | CONTACT RESISTANCE 接触电阻 | MEASURED AT SMALL CURRENT (100m A OR LESS) 1000Hz 在微小电流 (100 m A) 以下测试 | 40m Ω MAX |
| 3.2 | INSULATION RESISTANCE 绝缘电阻 | APPLY A VOLTAGE OF 100V DC FOR 1 MIN TO FOLLOWING PORTIONS AFTER WHICH MEASUREMENT SHALL BE MADE: (1) BETWEEN BODY AND CONDUCTOR (2) BETWEEN CONDUCTORS NOT TO BE CONTACT (3) BETWEEN CONDUCTORS NOT TO BE WHEN PLUG IS INSERTED DC100V 1 MIN 输入 100V DC 电压 1 分钟, 按以下接触方法测试: (1) 插座体与排脚之间 (2) 不接触的排脚之间 (3) 插头插入时不接触排脚之间 | 100M Ω MIN |

| | | | |
|-----|-----------------------------------|---|--|
| 3.3 | DIELECTRIC STRENGTH 耐电压 | AC 100V 5ms(50~60Hz)FOR 1 MIN TRIP CURRENT:0.5mA (1) BETWEEN BODY AND CONDUCTOR (2) BETWEEN CONDUCTORS NOT TO BE CONTACT (3) BETWEEN CONDUCTORS NOT TO BE WHEN PLUG IS INSERTED DC 100V 1 MIN 输入 AC 100V (50Hz) /min 电压 1 分钟感度电流为 0.5mA, 按以下接触方法测试: (1) 插座体与排脚之间 (2) 不接触的排脚之间 (3) 插头插入时不接触排脚之间 | WITHOUT DAMAGE TO PARTS ARCING OR BREAKDOWN ETC 没有绝缘破坏等异常 |
|-----|-----------------------------------|---|--|

URABILITY (耐久性)

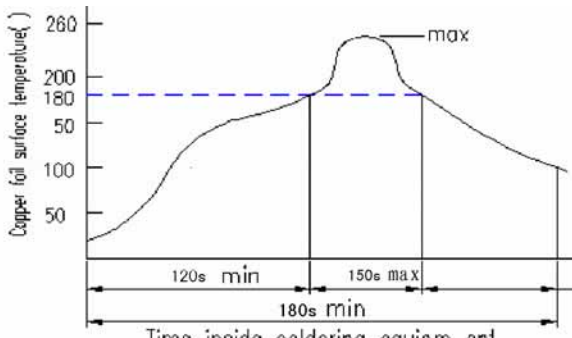
| ITEM 项目 | TEST CONDITIONS 测试条件 | PERFORMANCE 规格 |
|---------|--|--|
| 4. 1 | SOLDERABILITY TEST 可焊性试验 THE TOP OF THE TERMINALS SHALL BE DIPPED 1mm IN THE SOLDER BATH OF 250±5°C FOR 5±0.5 SECONDS 端子顶部被浸入锡池中 1mm 深,温度为 250±5°C,时间为 5±0.5 秒 | (1) SOLDER WETTING TIME SHALL BE 3 SEC OR LESS 焊接时间应少于 3 秒 (2) THE AREA OF SOLDERING SHOULD BE OVER 75% 焊接面积应有 75%以上 |
| 4.2 | RESISTANCE TO SOLDERING HEAT TEST 耐焊性试验 REFLOW SOLDERING CONDITIONS: PREHEAT:TEMPERATURE ON THE COPPER FOIL SURFACE SHOULD REACH 180 .120S AFTER THE P.C.B ENTERED INTO THE SOLDERING EQUIPMENT. TALLEST TEMPERATURE:TEMPERATURE ON THE COPPER FOIL SURFACE SHOULD REACH THE PEAK TEMPERATURE OF 260±5 WITH IN 20 SECONDS. 过回流焊条件: 预热:电镀层表面的温度应达到 180°C,120s 后电路板进入回流焊设备。 最高温度:电镀层表面温度最高为 260±5°C且停留不超过 20 秒。  | WITHOUT DEFOR MATION OF CASE OR EXCESSIVE LOOSENESS OF TEMINALS ELECTRICAL CHARACTERISTICS SHALL BE SATISFIED 本体无变形, 满足于机械、电气性能 |

| | | | |
|------|--|---|--|
| 4. 2 | <p>RESISTANCE TO SOLDERING HEAT TEST 耐焊性试验</p> | <p>SOLDERING IRON METHOD: BIT TEMPERATURE $330 \pm 5^{\circ}\text{C}$ APPLICATION TIME OF SOLDERING IRON $3 \pm 0.5 \text{ SEC}$ HOWEVER EXCESSIVE PRESSURE SHALL NOT BE APPLIED TO THE TERMINAL 手焊接的时候温度需控制在 $330 \pm 5^{\circ}\text{C}$, 时间为 3 ± 0.5 秒, 但不能在排脚上施加异常压力。</p> | <p>WITHOUT DEFORMATION OF CASE OR EXCESSIVE LOOSENESS OF TEMINALS ELECTRICAL CHARACTERISTICS SHALL BE SATISFIED 本体无变形, 满足于机械、电气性能</p> |
| 4. 3 | <p>HUMIDITY TEST 潮湿试验</p> | <p>THE JACK SHALL BE STORED AT A TEMPERATURE OF $40 \pm 2^{\circ}\text{C}$ AND A HUMIDITY OF 90% TO 96% FOR 96 Hr, THEN THE JACK SHALL BE MAINTAINED AT STANDARD ATMOSPHERIC CONDITION FOR 1 Hr FOR OTHER PROCEDURES 放置 $40 \pm 2^{\circ}\text{C}$ 的相应湿度为 90~96% Hr 环境中 96 小时后, 再将样板放在正常环境中 1 小时后进行测试</p> | <p>THERE SHALL BE NO DAMAGE ON APPEARANCE. MECHANICAL AND ELECTRICAL CHARACTERISTICS SHALL BE SATISFIED 外观无异常, 满足于机械、电气性能。</p> |
| 4.4 | <p>HEAT TEST 耐热试验</p> | <p>THE JACK SHALL BE STORED AT A TEMPERATURE OF $70 \pm 2^{\circ}\text{C}$ FOR 96 HOURS, AND THEN IT SHALL BE SUBJECTED TO THE CONTROLLED RECOVERY MBASURBM 放置在温度 $70 \pm 2^{\circ}\text{C}$ 中测试 96 小时后, 再放置正常室温中 1 小时来测定</p> | |
| 4. 5 | <p>COLD TEST 耐寒试验</p> | <p>THE JACK SHALL BE STORED AT A TEMPERATURE OF $-25 \pm 3^{\circ}\text{C}$ FOR 96 HOURS AND THEN IT SHALL BE SUBJECTED TO THE CONTROLLED RECOVERY CONDITIONS FOR 1 HOUR AFTER WHICH 放置在温度 $-25 \pm 3^{\circ}\text{C}$ 中 96 小时后, 再放置常温常湿中 1 小时来测定</p> | <p>THERE SHALL BE NO DAMAGE ON APPEARANCE MECHANICAL AND ELECTRICAL CHARACTERISTICS SHALL BE SATISFIED 外观无异常, 满足于机械、电气性能</p> |
| 4. 6 | <p>LIFE TEST 寿命试验</p> | <p>WITHOUT LOAD CONNECTION AND DISCONNECTION SHALL BE MADE WITH THE MATING PLUGS AND JACKS FOR 5000 CYCLES AT A SPEED OF 10 TO 25 CYCLES/MIN 无负荷 将结合了的的标准 Plug (尽量要近于中心的) 在 1 分钟内以 10-25 的速度, 进行 5000 次插入, 拔出 LOAD: AT RATING CONDITION (NON-INDUCTIVE LOAD) CONNECTION AND DISCONNECTION SHALL BE MADE 5000 CYCLES AT A SPEED 10 TO 20 CYCLES / MIN 负荷 以定格状态(无诱导负荷)在 1 分钟内以 10-20 次的速度进行 5000 次插入、拔出</p> | <p>(1) CONTACT RESISTANCE SHALL BE $\leq 0.1 \Omega$ (2) DISCONNECTION FORCE SHALL BE 0.8 TO 2.0N (3) MECHANICAL AND ELECTRICAL CHARACTERISTICS SHALL BE SATISFIED (1) 接触电阻 $\leq 0.1 \Omega$ (2) 拔出力是 0.8~2.0N (3) 其它: 满足于机械、电气性能</p> |

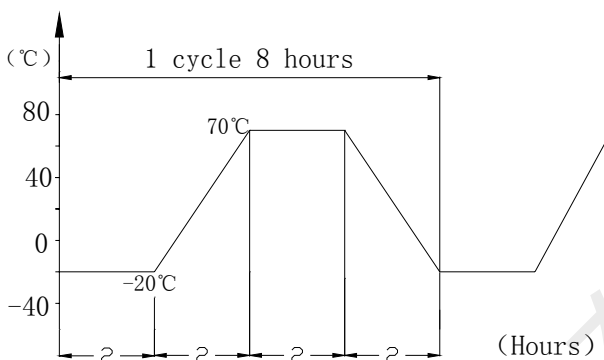
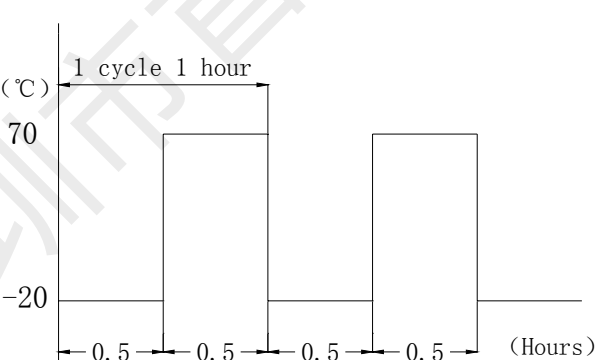
| | | | |
|------------|--|--|--|
| <p>4.7</p> | <p>TEMPERATURE CYCLING TEST 温度循环测试</p> | <p>THE JACK SHALL BE SUB JECTED TO 5 CYCLES OF THE FOLLOWING CONDITIONS SHOWN IN THE FIGURE,AND THEN SHALL RETURNED ALLOWED TO REMAIN IN ROOM AMBIENT CONDITION FOR 30 MINUTES 将插座以下列条件作 5 个循环，然后放回室内环境 30 分钟</p> <p>Temp(°C)</p>  <p>(Hours)</p> | <p>THERE SHALL BE NO DEFORMATION OR CRACKS IN MOLDED PART. INSERTION & EXTRACTION FORCE:3 TO 20N CONTACT RESISTANCE:MAX.30M Ω INSULATION RESISTANCE: MIN.100 M Ω DIELECTRIC WITHSTANDING VOLTAGE: 100VAC/MIN(BETWEEN TERMINALS)</p> <p>产品不能变形与破裂 插拔力：3N 至 20N 接触电阻：最大 30m Ω 绝缘电阻：最小 100 M Ω 绝缘耐压：最小 100VAC（端子之间）</p> |
| <p>4.8</p> | <p>COLD&HEAT SHOCK TEST 冷热冲击测试</p> | <p>THE JACK SHALL BE SUBJECTED TO 5 CYCLES OF THE FOLLOWING CONDITIONS SHOWN IN THE FIGURE,AND THEN SHALL RETURNED AND ALLOWED TO REMAIN IN ROOM AMBIENT CONDITION FOR 30 MINUTES 将插座以下列条件作 5 个循环，然后放回室内环境 30 分钟</p> <p>TEMP (°C)</p>  <p>(Hours)</p> | <p>THERE SHALL BE NO DEFORMATION OR CRACKS IN MOLDED PART. INSERTION & EXTRACTION FORCE:3 TO 25N CONTACT RESISTANCE:MAX.30M Ω INSULATION RESISTANCE: MIN.100 M Ω DIELECTRIC WITHSTANDING VOLTAGE: 500VAC/MIN(BETWEEN TERMINALS)</p> <p>产品不能变形与破裂 插拔力：3N 至 25N 接触电阻：最大 30m Ω 绝缘电阻：最小 100 M Ω 绝缘耐压：最小 500VAC（端子之间）</p> |

X-ON Electronics

Largest Supplier of Electrical and Electronic Components

Click to view similar products for [USB Connectors](#) category:

Click to view products by [SHOU](#) manufacturer:

Other Similar products are found below :

[950](#) [A-USB A-LP-SMT-C](#) [A-USB B-TOP-C](#) [MUSBD11135](#) [17-200721](#) [217450-1](#) [KMBVX-TH-5S-B30](#) [KUSBX-AS2N-W](#) [KUSBX-SMT2AP1S-W30](#) [935](#) [957](#) [30-498-6](#) [SK-60A-2](#) [1734082-1](#) [30-470](#) [30-489](#) [30-541](#) [MAB 5 S](#) [A-USB A-2P-C](#) [MIKROE-1451](#)
[USBFTVSCCG](#) [1-1734084-2](#) [MUSBA81130](#) [NK-27-32SL](#) [NK-L8-22C-5/8](#) [10135326-001LF](#) [4198](#) [690-024-633-031](#) [UB-20PMFP-LC7001](#)
[17-200011](#) [UB-20AFMM-LL7A01](#) [CAP-WCCMLPB1](#) [CAP-WCCMLPC1](#) [2274475-3](#) [914-614A2025S10200](#) [USB3FTV7SAGF059](#)
[USB3FTV2SAZNF459](#) [USB3FTV7SAZNF459](#) [HYCW153-USBD05-500B](#) [HYCW148-USBD05-117B](#) [HYCW149-USBD05-740B](#)
[HYCW214-USBA04-113B](#) [HYCW213-USBA04-113B](#) [KMMX-BSMT35S-1-B30TR](#) [2345986-1](#) [10082141-N340LF](#) [10117836-011LF](#)
[GSB3C3133DSYHR](#) [GT-USB-2014-CWG1](#) [GT-USB-7010ANS](#)