



IMM

INDUCTIVE MINIATURE SENSORS FOR INDUSTRIAL APPLICATIONS

Inductive proximity sensors

SICK
Sensor Intelligence.

NOTHING IS TOO SMALL TO BE THE VERY BEST OF ALL

It is impossible today to imagine industrial automation without inductive proximity sensors – even though the IMM sensor product family is often barely noticed due to its size. They reliably detect metal objects without contact, and are characterized by their durability and long service life. Equipped with state-of-the-art ASIC technology, they impress with their concentrated sensor power – packaged in compact cylindrical miniature housing.

The sensors in the IMM product family are characterized by their minimal space requirements. They are ideal for use in highly dynamic environments due to their low weight and their compact design.

Whether in robotics, in handling processes or in assembly applications: all IMM products cut down on space – but not on performance. These durable stainless steel inductive proximity sensors are available in Ø 3 mm, Ø 4 mm, Ø 6.5 mm as well as in M4 and M5 models.



ULTRAFAST FOR THE WORLD RECORD

The IH03 and IM04 belong to the smallest inductive proximity sensors on the market. But they have no reason to hide: The only 12 mm small housing is packed with high-performance sensor electronics. This makes them the perfect choice if the available installation space is small and valuable. There is always enough space for the extremely small and lightweight inductive sensors with a housing diameter of 3 mm or M4 –

and thanks to the fully integrated electronics, they don't need external amplifiers. Equipped with ASIC technology from SICK and IO-Link compatibility, the IH03 and IM04 furthermore impress with their extremely precise double switching distance of 1 mm. The ultrasmall powerhouses hold another world record with their ultrafast detection range of 8 kHz.

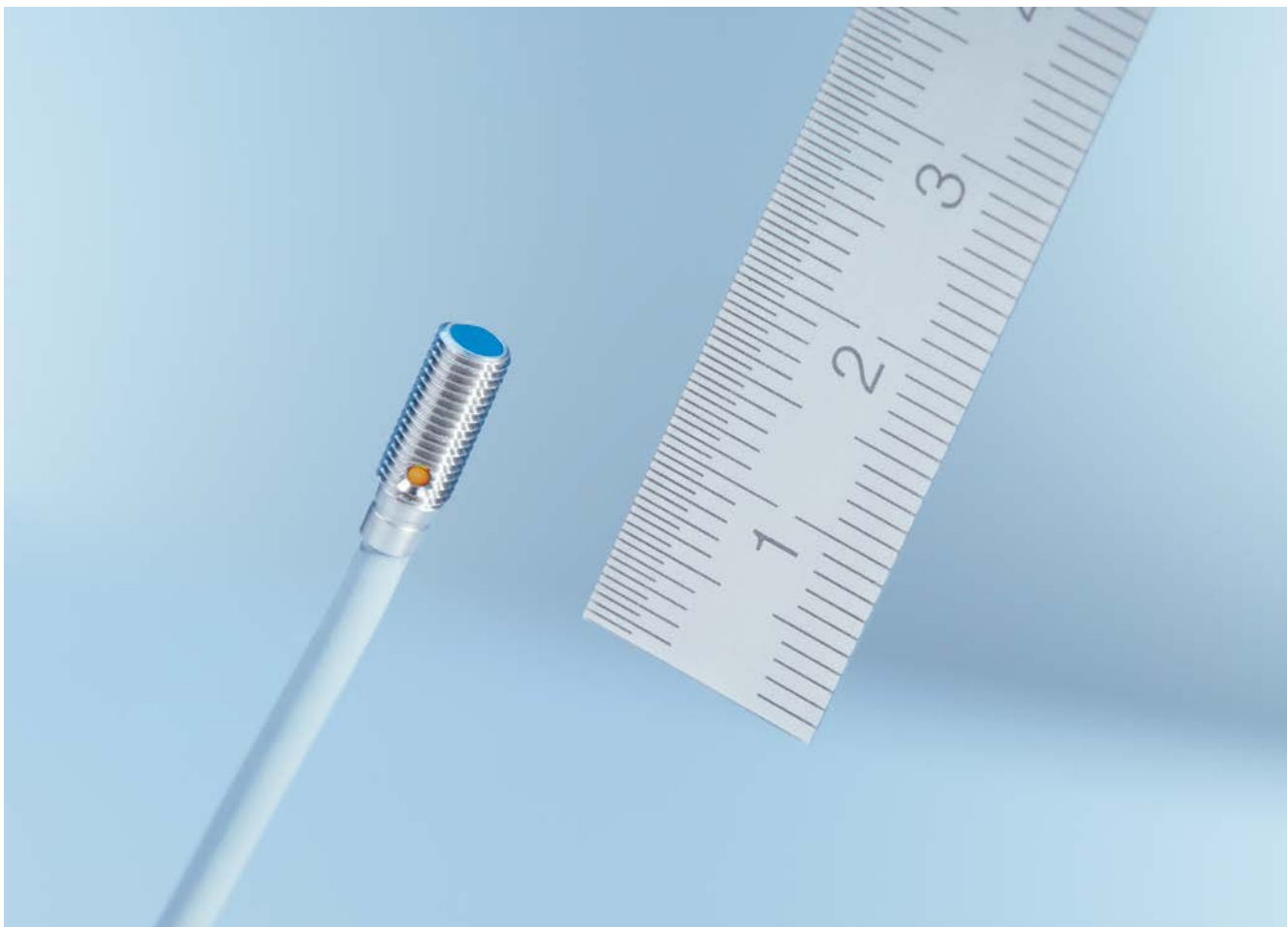

The benefits at a glance

- Easy installation in applications with limited space
- Reliable detection of fast handling and assembly processes
- High positioning accuracy and precise switching behavior
- Great freedom with respect to machine design
- The low weight of the sensor enables fast acceleration in dynamic handling processes
- IO-Link provides easy data access from the PLC
- Very simple sensor diagnostics, device replacement and identification through IO-Link

RELIABILITY IN THE SMALLEST OF SPACES

The ultrashort IH03 and IM04 designs, which have the perfect design for use in handling grippers, tool spindles and fast assembly processes, enable positioning tasks that were previously impossible to achieve with inductive proximity sensors.

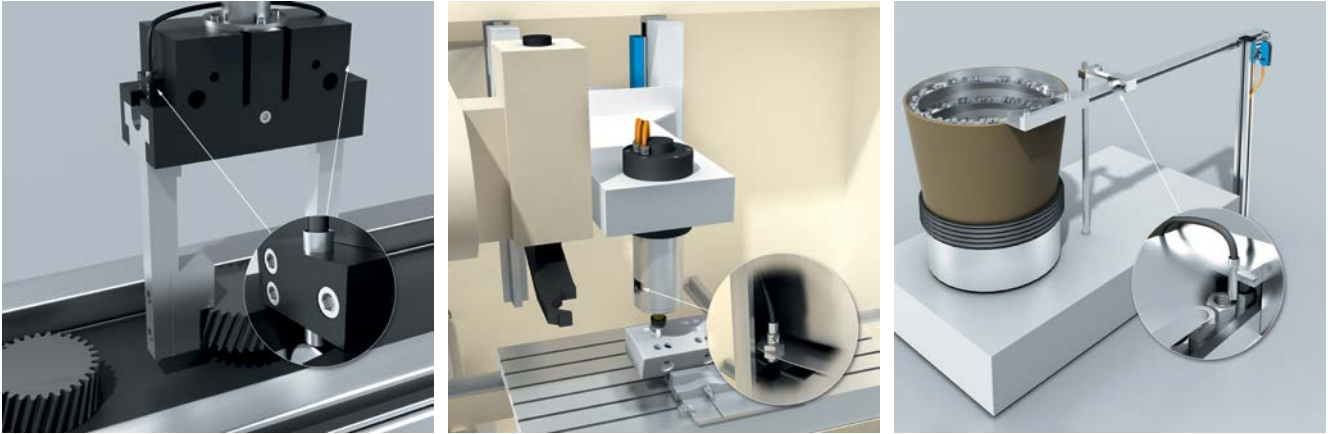

Application areas

- Positioning in fast handling assembly processes
- Speed monitoring and positioning in tool spindles
- Identifying whether a gripper is open or closed
- Detecting the end and reference position in linear units
- Detecting small components in supply processes
- Wear control and monitoring of industrial brakes
- Detecting contact pins in machines during printed circuit board testing

SELECTION GUIDE

	Threat size/ diameter	Housing and und sensing range S_n					Page
		Ultrashort	Short-body		Standard-body		
			Flush	Flush	Non-flush	Flush	
IH03	Ø 3 mm	1 mm	-	-	0.6 mm	0.6 mm	→ 6
IHP03	Ø 3 mm	0.8 mm	-	-	-	-	→ 6
IM04	M4	1 mm	-	-	0.6 mm	0.6 mm	→ 12
IH04	Ø 4 mm	-	-	-	0.8 mm	0.8 mm	→ 16
IM05	M5	-	-	-	0.8 mm/1.5 mm	-	→ 20
IH06	Ø 6.5 mm	1.5 mm	2 mm	4 mm	2 mm	4 mm	→ 24

The sensors available in the M4 or M5 models and with a sleeve diameter of 3 mm, 4 mm and 6.5 mm can be installed flush or non-flush in various applications. You will be able to reliably detect metals in fast handling and assembly processes with a maximum sensing range of up to 1.5 mm (metric) or up to 4 mm (sleeve design).

SICK – WE UNDERSTAND

In addition to their high performance capacity, the inductive sensors by SICK also fulfill the basic conditions. The inductive sensors are characterized by their worldwide availability, the best delivery performance and an extensive portfolio – and make SICK the right partner for you.

If, despite the extensive portfolio selection, no suitable sensor is available, our customer-specific adaptations provide an even higher degree of flexibility. Our goal: the right sensor for your application – and at the right time.

Even for tricky tasks. Thanks to worldwide support in over 88 countries, SICK will work with you to always find a solution.

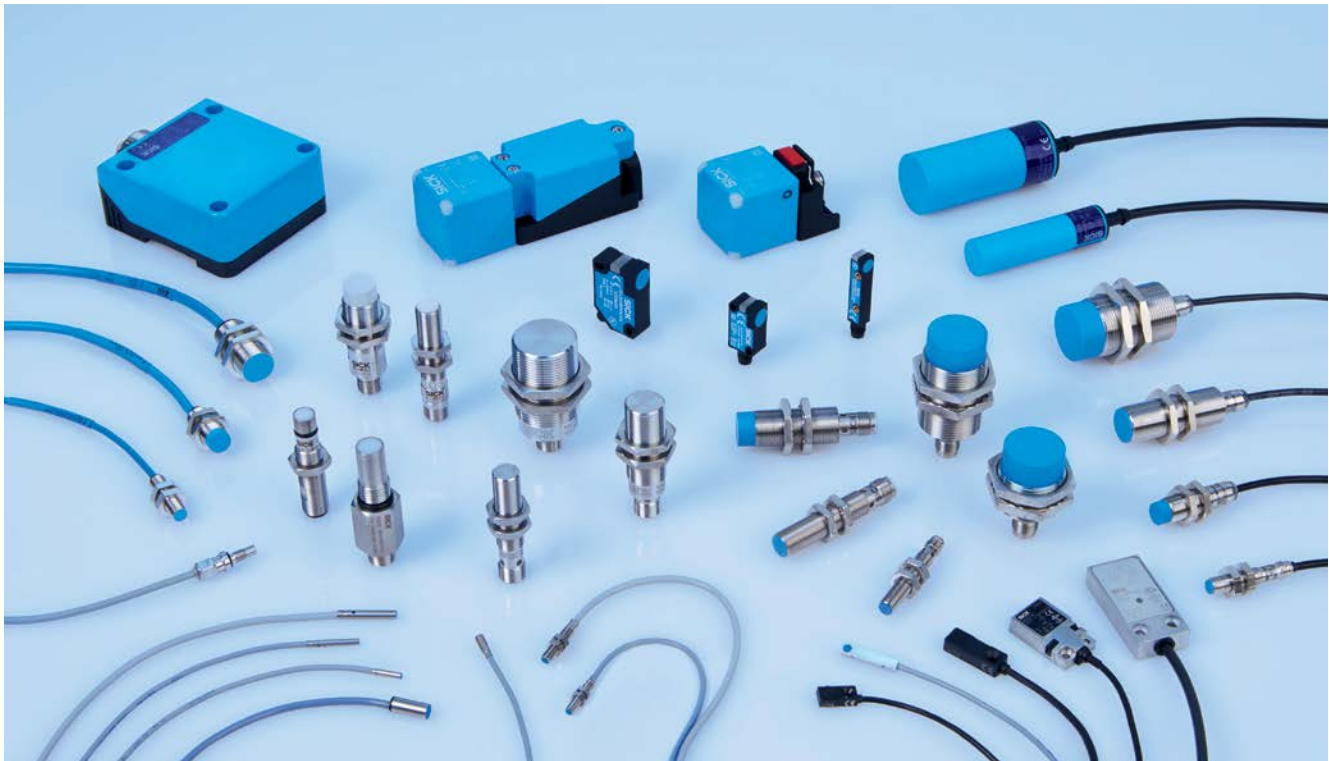
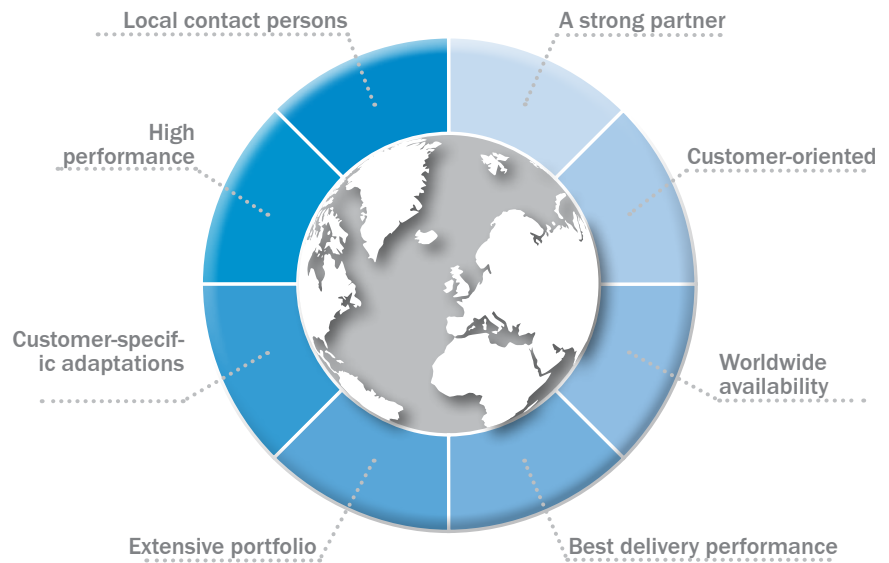

As a major player in automation technology, partnership with SICK offers you many benefits. Our goal is to continue driving innovation in the industry, even in areas neglected by others – and we want to do this across all sectors. Our global network of production plants with unified quality standards guarantees a

safe and reliable supply. Our elaborate logistics concept ensures rapid availability on site, regardless of which of our over 40,000 products you require. The individual needs of our customers are paramount to SICK. Our local sales department will advise and support you with your automation projects. Together

with our regional development and competence centers, we thus create added value for our customers.

THE SMALLEST AND SHORTEST INDUCTIVE MINIATURE SENSORS IN THE WORLD



Product description

With a minimal overall length of just 12 mm, the IH03 inductive miniature sensors have set a new world record. Thanks to their fully integrated electronics, they do not require an external amplifier. The sensor has been specially developed for applications with limited available space, e.g., handling claws, linear units, or tool spindles. As a result, positioning tasks can be performed in places where this was previously impos-

sible. The IH03 is not just extremely short but also very powerful thanks to the latest ASIC technology with a sensing range of up to one millimeter. With the extremely high switching frequency of up to 8,000 Hz, the inductive miniature sensors also cope with the quickest handling processes with ease. Thanks to the integrated IO-Link communication, it is ideally equipped for the future.

At a glance

- Type, diameter: 3 mm
- Increased sensing range: up to 1 mm flush
- Electrical configuration: DC, 3-wire
- Temperature range: -25 °C to 70 °C
- Rugged stainless-steel housing, sensing face made of plastic
- Extremely compact, lightweight, and space-saving
- Integrated amplifier, suppressor, and LED display
- IO-Link-capable

Your benefits

- Easy installation in applications with limited available space
- Reliable detection of fast handling and assembly processes
- High positioning accuracy and precise switching behavior
- Great freedom with respect to machine design
- The low weight of the sensor enables fast acceleration in dynamic handling processes
- IO-Link provides easy data access from the PLC
- Simple sensor diagnostics, device change, and identification through IO-Link



Additional information

Detailed technical data	7
Ordering information	8
Dimensional drawings	9
Connection diagram	9
Installation note	10
Response curve	10
Temperature derating	10
Recommended accessories	30

→ www.mysick.com/en/IH03

For more information, just enter the link or scan the QR code and get direct access to technical data, CAD design models, operating instructions, software, application examples and much more.



Detailed technical data

Features

	Ultrashort	Ultrashort	Standard-body
Housing	Cylindrical		
Diameter	Ø 3 mm		
Pressure resistance	≤ 150 bar	-	
Sensing range S_n	0.8 mm	1 mm	0.6 mm
Assured sensing range S_a	0.65 mm	0.81 mm	0.486 mm
Installation type	Flush		
Switching frequency	8,000 Hz		5,000 Hz
Output type	PNP / NPN (depending on type)		
Output function	NO		NC / NO (depending on type)
Electrical wiring	DC 3-wire		
Enclosure rating	IP 68 IP 69K	IP 67 ¹⁾	
Special features	-	Capable of communication via IO-Link 1.0	-

¹⁾ According to EN 60529.

Mechanics/electronics

	Ultrashort	Ultrashort	Standard-body
Supply voltage	10 V DC ... 30 V DC		
Ripple ¹⁾	≤ 20 %		
Voltage drop ²⁾	≤ 2 V		
Current consumption	≤ 10 mA ³⁾		
Time delay before availability	≤ 10 ms		
Hysteresis	1 % ... 10 %		
Repeatability ⁴⁾	≤ 2 %		
Temperature drift (of S_n)	± 10 %		
EMC	EN 60947-5-2 IEC 61000-4-2: (Testlevel 2) IEC 61000-4-4: (Testlevel 2)	EN 60947-5-2 IEC 61000-4-2: (Testlevel 2) IEC 61000-4-4: (Testlevel 3)	EN 60947-5-2 IEC 61000-4-2: (Testlevel 2) IEC 61000-4-4: (Testlevel 2)
Continuous current I_a	≤ 100 mA		
Connection type	Cable, 2 m, PUR ⁵⁾	Cable, 2 m, PUR ⁵⁾ Cable with male connector, M8, 0.2 m, PUR ⁵⁾ (depending on type)	Cable, 2 m, PUR Cable, 5 m, PUR Cable with connector and knurled nuts, M8, 0.2 m, PUR (depending on type)
Short-circuit protection	✓		
Reverse polarity protection	✓		
Shock and vibration resistance	30 g, 11 ms / 10 ... 55 Hz, 1 mm		
Ambient operating temperature	-25 °C ... +70 °C		
Housing material	Stainless steel (V2A, 304)		
Sensing face material	Ceramics, ZrO2	Plastic, POM	
UL File No.	NRKH.E191603		

¹⁾ Of V_s.

²⁾ With I_a = 100 mA.

³⁾ Without load.

⁴⁾ U_b = 20 V DC ... 30 V DC, T_a = 23 °C ± 5 °C.

⁵⁾ Do not bend below 0 °C.

Reduction factors

	Ultrashort	Ultrashort	Standard-body
Note	The values are reference values which may vary		
Stainless steel (V2A, 304)	Approx. 0.8	Approx. 0.8	Approx. 0.8
Aluminum (Al)	Approx. 0.5	Approx. 0.5	Approx. 0.55
Copper (Cu)	Approx. 0.45	Approx. 0.45	Approx. 0.5
Brass (Br)	Approx. 0.6	Approx. 0.6	Approx. 0.65

Ordering information

Other models → www.mysick.com/en/IH03

Ultrashort, high pressure

- **Housing:** Ø 3 mm

Installation type	Sensing range S_n	Output function	Output type	Connection	Connection diagram	Type	Part no.
Flush	0.8 mm	NO	PNP	Cable, 3-wire, 2 m, PUR	Cd-001	IHP03-0B8PSVU2K	6058033
			NPN	Cable, 3-wire, 2 m, PUR	Cd-001	IHP03-0B8NSVU2K	6058032

Ultrashort

- **Housing:** Ø 3 mm

Installation type	Sensing range S_n	Output function	Output type	Connection	Connection diagram	Type	Part no.
Flush	1 mm	NO	PNP	Cable, 3-wire, 2 m, PUR	Cd-001	IH03-01BPSVU2K	6058025
				Cable with connector M8, 3-pin, 0.2 m, PUR	Cd-002	IH03-01BPSVR8K	6058027
			NPN	Cable, 3-wire, 2 m, PUR	Cd-001	IH03-01BNSVU2K	6058024
				Cable with connector M8, 3-pin, 0.2 m, PUR	Cd-002	IH03-01BNSVR8K	6058026

Standard-body

- **Housing:** Ø 3 mm

Installation type	Sensing range S_n	Output function	Output type	Connection	Connection diagram	Type	Part no.
Flush	0.6 mm	NC	PNP	Cable, 3-wire, 2 m, PUR	Cd-003	IH03-0B6PO-VU1	6020143
				Cable, 3-wire, 2 m, PUR	Cd-001	IH03-0B6PS-VU1	6020141
		NO	PNP	Cable, 3-wire, 5 m, PUR	Cd-001	IH03-0B6PS-VUB	6020630
				Cable with connector M8, 3-pin, with knurled nuts, 0.2 m, PUR	Cd-002	IH03-0B6PS-VR1	6038602
				Cable, 3-wire, 2 m, PUR	Cd-001	IH03-0B6NS-VU1	6020142

Dimensional drawings (Dimensions in mm (inch))

Ultrashort, flush, cable, IHPO3

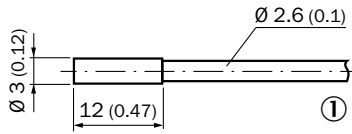

① Connection

Ultrashort, flush, cable with connector

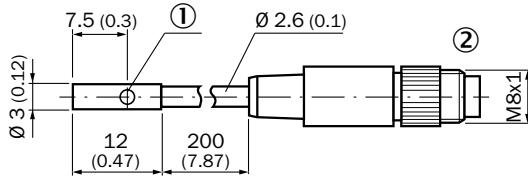

① Display LED
② Connection

Standard-body, non-flush, cable with connector, with knurled nuts

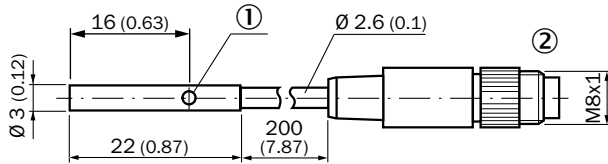

① Display LED
② Connection

Ultrashort, flush, cable

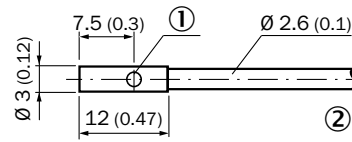

① Display LED
② Connection

Standard-body, flush, cable

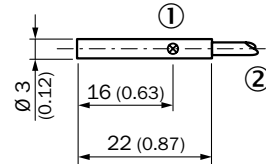

① Display LED
② Connection

Connection diagram

Cd-001

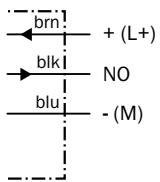

Cd-002

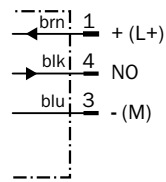

Cd-003

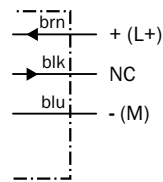

Installation note

Flush installation

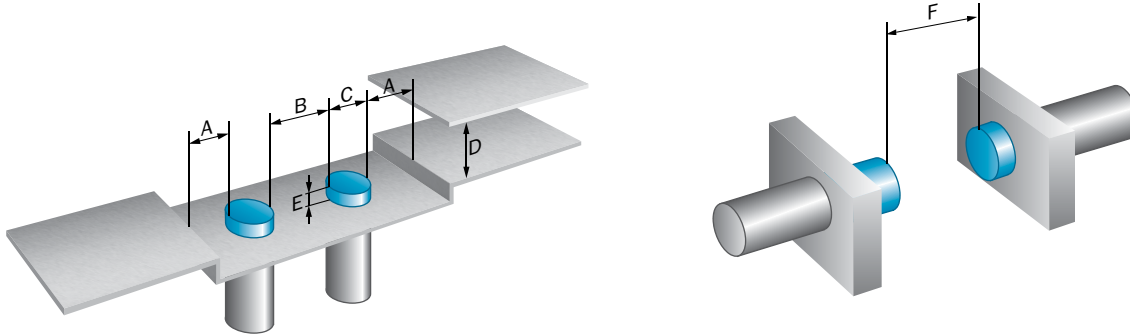

Installation note

	Installation type	Sensing range S_n	A	B	C	D	E	F
IHP03 ultrashort	Flush	0.8 mm	1 mm	2 mm	3 mm	3 mm	0 mm	7 mm
IH03 ultrashort	Flush	1 mm	1 mm	2 mm	3 mm	3 mm	0 mm	8 mm
IH03 standard body	Flush	0.6 mm	0.5 mm	0 mm	3 mm	1.8 mm	0 mm	5 mm

Response curve

IHP03-0B8xxxxxx

Distance in mm (inch)

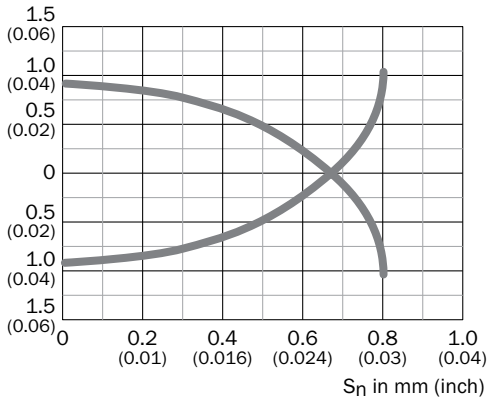

IH03-01Bxxxxxx

Distance in mm (inch)

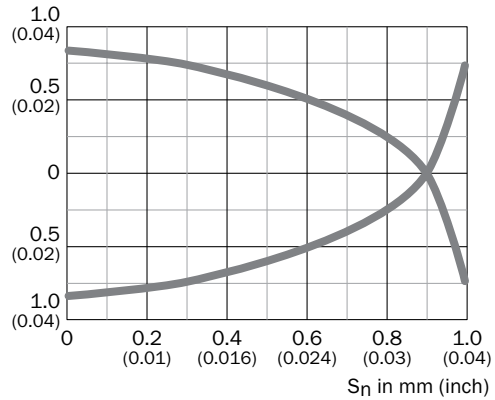

Temperature derating

IH03

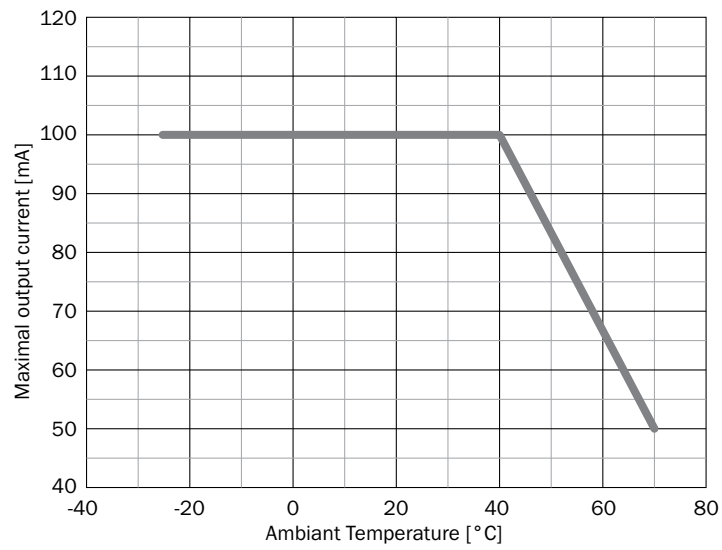

THE SMALLEST AND SHORTEST INDUCTIVE MINIATURE SENSORS IN THE WORLD

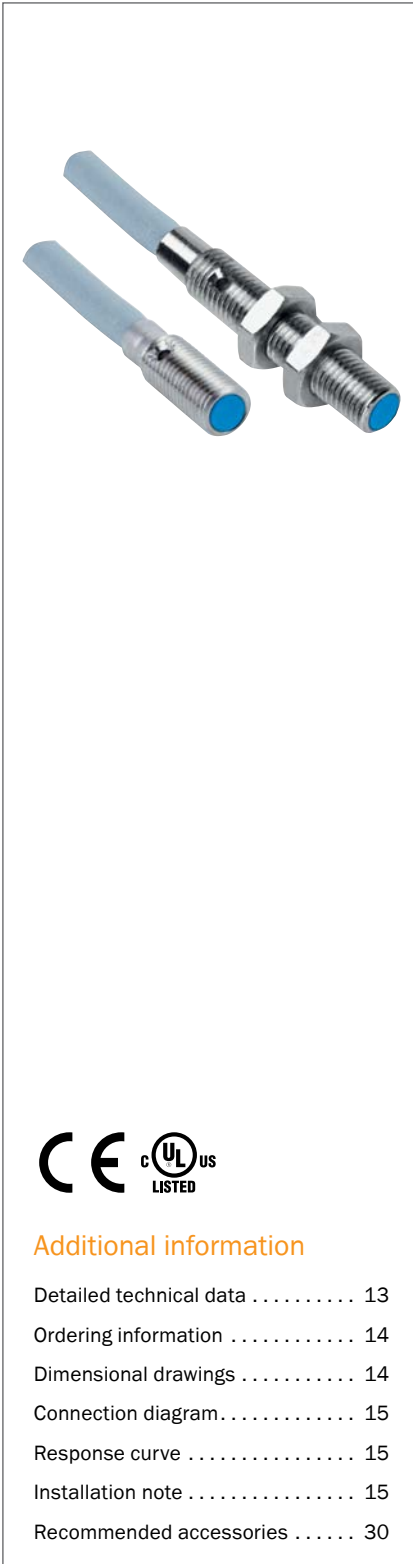

Additional information

Detailed technical data 13
 Ordering information 14
 Dimensional drawings 14
 Connection diagram 15
 Response curve 15
 Installation note 15
 Recommended accessories 30

Product description

With a minimal overall length of just 12 mm, the IM04 inductive miniature sensors have set a new world record. Thanks to their fully integrated electronics, they do not require an external amplifier. The sensor has been specially developed for applications with limited available space, e.g., handling claws, linear units, or tool spindles. As a result, positioning tasks can be performed in places where this was previously impos-

sible. The IM04 is not just extremely short but also very powerful thanks to the latest ASIC technology with a sensing range of up to one millimeter. With the extremely high switching frequency of up to 8,000 Hz, the inductive miniature sensors also cope with the quickest handling processes with ease. Thanks to the integrated IO-Link communication, it is ideally equipped for the future.

At a glance

- Type, M4
- Increased sensing range: up to 1 mm flush
- Electrical configuration: DC, 3-wire
- Temperature range: -25 °C to 70 °C
- Rugged stainless-steel housing, sensing face made of plastic
- Extremely compact, lightweight, and space-saving
- Integrated amplifier, suppressor, and LED display
- IO-Link-capable

Your benefits

- Easy installation in applications with limited available space
- Reliable detection of fast handling and assembly processes
- High positioning accuracy and precise switching behavior
- Great freedom with respect to machine design
- The low weight of the sensor enables fast acceleration in dynamic handling processes
- IO-Link provides easy data access from the PLC
- Simple sensor diagnostics, device change, and identification through IO-Link

→ www.mysick.com/en/IM04

For more information, just enter the link or scan the QR code and get direct access to technical data, CAD design models, operating instructions, software, application examples and much more.



Detailed technical data

Features

	Ultrashort	Standard-body
Housing	Cylindrical	
Thread size	M4 x 0.5	
Sensing range S_n	1 mm	0.6 mm
Assured sensing range S_a	0.81 mm	0.486 mm
Installation type	Flush	
Switching frequency	8,000 Hz	5,000 Hz
Output type	PNP / NPN (depending on type)	
Output function	NO	NC / NO (depending on type)
Electrical wiring	DC 3-wire	
Enclosure rating ¹⁾	IP 67	
Special features	Capable of communication via IO-Link 1.0	-

¹⁾ According to EN 60529.

Mechanics/electronics

	Ultrashort	Standard-body
Supply voltage	10 V DC ... 30 V DC	
Ripple ¹⁾	≤ 20 %	
Voltage drop ²⁾	≤ 2 V	
Current consumption	≤ 10 mA ³⁾	
Time delay before availability	≤ 10 ms	
Hysteresis	1 % ... 10 %	
Repeatability ⁴⁾	≤ 2 %	
Temperature drift (of S_r)	± 10 %	≤ 10 %
EMC	EN 60947-5-2 IEC 61000-4-2: (Testlevel 2) IEC 61000-4-4: (Testlevel 3)	EN 60947-5-2 IEC 61000-4-2: (Testlevel 2) IEC 61000-4-4: (Testlevel 2)
Continuous current I_a	≤ 100 mA	
Connection type	Cable, 2 m, PUR ⁵⁾ Cable with male connector, M8, 0.2 m, PUR ⁵⁾ (depending on type)	Cable, 2 m, PUR ⁵⁾ Cable, 5 m, PUR ⁵⁾ Cable with connector and knurled nuts, M8, 0.2 m, PUR ⁵⁾ (depending on type)
Short-circuit protection	✓	
Reverse polarity protection	✓	
Shock and vibration resistance	30 g, 11 ms / 10 ... 55 Hz, 1 mm	
Ambient operating temperature	-25 °C ... +70 °C	
Housing material	Stainless steel (V2A, 304)	
Sensing face material	Plastic, POM	
Tightening torque, max.	≤ 0.8 Nm	
UL File No.	NRKH.E191603	

¹⁾ Of V_s .

²⁾ With $I_a = 100$ mA.

³⁾ Without load.

⁴⁾ $U_b = 20$ V DC ... 30 V DC, $T_a = 23$ °C ± 5 °C.

⁵⁾ Do not bend below 0 °C.

Reduction factors

	Ultrashort	Standard-body
Note	The values are reference values which may vary	
Stainless steel (V2A, 304)	Approx. 0.8	Approx. 0.8
Aluminum (Al)	Approx. 0.5	Approx. 0.55
Copper (Cu)	Approx. 0.45	Approx. 0.5
Brass (Br)	Approx. 0.6	Approx. 0.65

Ordering information

Other models → www.mysick.com/en/IM04

Ultrashort

- **Housing:** M4 x 0.5

Installation type	Sensing range S_n	Output function	Output type	Connection	Connection diagram	Type	Part no.
Flush	1 mm	NO	PNP	Cable, 3-wire, 2 m, PUR	Cd-001	IM04-01BPSVU2K	6058029
				Cable with connector M8, 3-pin, 0.2 m, PUR	Cd-002	IM04-01BPSVR8K	6058031
			NPN	Cable, 3-wire, 2 m, PUR	Cd-001	IM04-01BNSVU2K	6058028
				Cable with connector M8, 3-pin, 0.2 m, PUR	Cd-002	IM04-01BNSVR8K	6058030

Standard-body

- **Housing:** M4 x 0.5

Installation type	Sensing range S_n	Output function	Output type	Connection	Connection diagram	Type	Part no.
Flush	0.6 mm	NC	PNP	Cable, 3-wire, 2 m, PUR	Cd-003	IM04-0B6PO-ZU1	6020147
				Cable, 3-wire, 2 m, PUR	Cd-001	IM04-0B6PS-ZU1	6020145
		NO	PNP	Cable, 3-wire, 5 m, PUR	Cd-001	IM04-0B6PS-ZUB	6020610
				Cable with connector M8, 3-pin, with knurled nuts, 0.2 m, PUR	Cd-002	IM04-0B6PS-ZR1	6042085
				NPN	Cable, 3-wire, 2 m, PUR	Cd-001	IM04-0B6NS-ZU1

Dimensional drawings (Dimensions in mm (inch))

Ultrashort, flush, cable

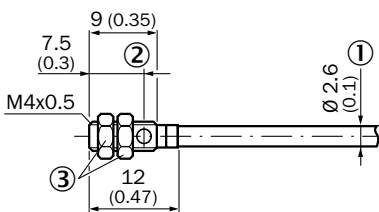

- ① Connection
- ② Display LED
- ③ Fastening nuts (2 x); 6 mm hex, stainless steel

Ultrashort, flush, cable with connector

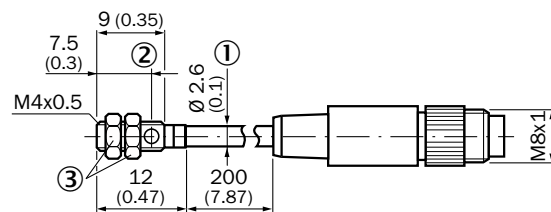

- ① Connection
- ② Display LED
- ③ Fastening nuts (2 x); 6 mm hex, stainless steel

Standard-body, flush, cable

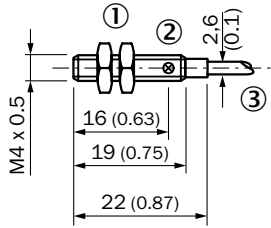

- ① Fastening nuts (2 x); 6 mm hex, stainless steel
- ② Display LED
- ③ Connection

Connection diagram

Cd-001

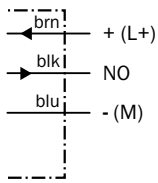

Cd-002

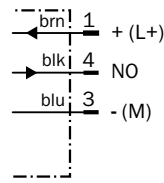

Standard-body, non-flush, cable with connector, with knurled nuts

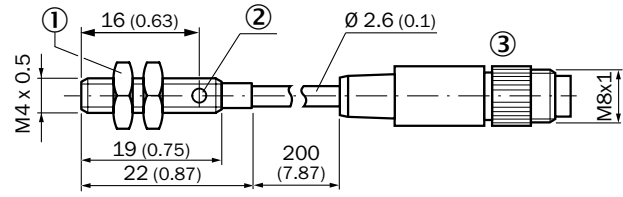

- ① Fastening nuts (2 x); 6 mm hex, stainless steel
- ② Display LED
- ③ Connection

Cd-003

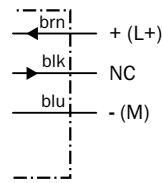

Response curve

IM04-01Bxxxxxx

Distance in mm (inch)

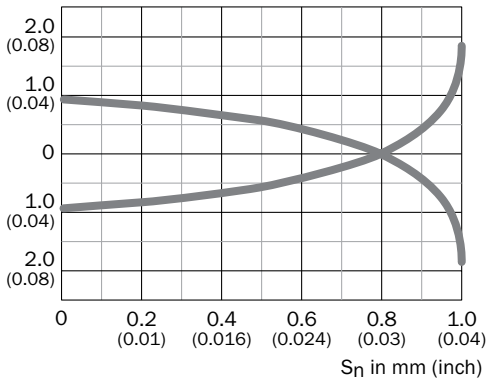

Installation note

Flush installation

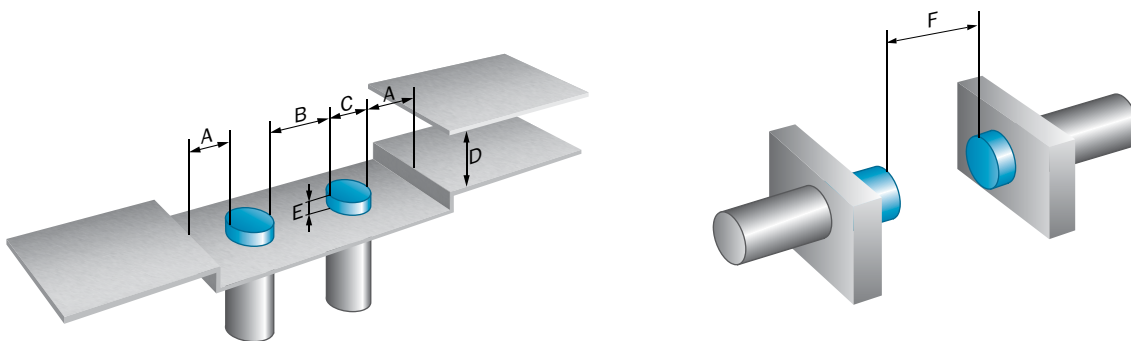

Installation note

	Installation type	Sensing range Sn	A	B	C	D	E	F
IM04 ultrashort	Flush	1 mm	1 mm	2 mm	3 mm	3 mm	0 mm	8 mm
IM04 standard body	Flush	0.6 mm	0 mm	0 mm	4 mm	1.8 mm	0 mm	5 mm

SMALL FORMAT – GREAT PERFORMANCE



Product description

With a diameter of just 4 mm and sensing ranges of up to 1.5 mm, the IH04 inductive proximity sensor is extremely space-saving, compact, lightweight, and powerful. Modern ASIC technology guarantees a full range of services in the smallest dimensions, allowing for easy

integration into compact housings and applications. With switching frequencies of up to 5 kHz, it copes with the quick assembly and handling processes with ease. What's more, the IH04 proves to be impressive in highly dynamic applications thanks to its lightweight design.

At a glance

- Type, diameter: 4 mm
- Increased sensing range: up to 0.8mm for flush installation
- Electrical configuration: DC, 3-wire
- Temperature range: -25 °C to 70 °C
- Rugged stainless-steel housing, sensing face made of plastic
- Extremely compact, lightweight, and space-saving
- Integrated amplifier, suppressor, and LED display

Your benefits

- Easy installation in applications with limited space
- Reliable detection of fast handling and assembly processes
- High positioning accuracy and precise switching behavior
- Great freedom with respect to machine design
- The low weight of the sensor enables fast acceleration in dynamic handling processes



Additional information

Detailed technical data	17
Ordering information	18
Dimensional drawings	18
Connection diagram	19
Installation note	19
Recommended accessories	30

→ www.mysick.com/en/IH04

For more information, just enter the link or scan the QR code and get direct access to technical data, CAD design models, operating instructions, software, application examples and much more.



Detailed technical data

Features

	Standard-body
Housing	Cylindrical
Diameter	Ø 4 mm
Sensing range S_n	0.8 mm
Assured sensing range S_a	0.648 mm
Installation type	Flush
Switching frequency	5,000 Hz
Output type	PNP / NPN (depending on type)
Output function	NO
Electrical wiring	DC 3-wire
Enclosure rating ¹⁾	IP 67

¹⁾ According to EN 60529.

Mechanics/electronics

	Standard-body
Supply voltage	10 V DC ... 30 V DC
Ripple ¹⁾	≤ 20 %
Voltage drop ²⁾	≤ 2 V
Current consumption ³⁾	≤ 10 mA
Time delay before availability	≤ 10 ms
Hysteresis	1 % ... 10 %
Repeatability ⁴⁾	≤ 1.5 %
Temperature drift (of S_n)	± 10 %
EMC	EN 60947-5-2 IEC 61000-4-2: (Testlevel 2) IEC 61000-4-4: (Testlevel 2)
Continuous current I_a	≤ 200 mA
Connection type	Male connector, M8 Cable, 85 mm, PUR Cable, 2 m, PVC, Cable with male connector, M8, 0.2 m, PVC (depending on type)
Short-circuit protection	✓
Reverse polarity protection	✓
Shock and vibration resistance	30 g, 11 ms / 10 ... 55 Hz, 1 mm
Ambient operating temperature	-25 °C ... +70 °C
Housing material	Stainless steel (V2A, 304)
Sensing face material	Plastic, PA66
UL File No.	NRKH.E191603

¹⁾ Of V_s .

²⁾ With $I_a = 200$ mA.

³⁾ Without load.

⁴⁾ $U_b = 20$ V DC ... 30 V DC, $T_a = 23$ °C ± 5 °C.

Reduction factors

	Standard-body
Note	The values are reference values which may vary
Stainless steel (V2A, 304)	Approx. 0.8
Aluminum (Al)	Approx. 0.5
Copper (Cu)	Approx. 0.45
Brass (Br)	Approx. 0.55

Ordering information

Other models → www.mysick.com/en/IH04

Standard-body

- **Housing:** \varnothing 4 mm

Installation type	Sensing range S_n	Output function	Output type	Connection	Connection diagram	Type	Part no.
Flush	0.8 mm	NO	PNP	Connector M8, 3-pin	Cd-002	IH04-0B8PS-VT1	6020114
				Cable, 3-wire, 85 mm, PUR	Cd-001	IH04-0B8PS-VUD	6054677
				Cable, 3-wire, 2 m, PVC	Cd-001	IH04-0B8PS-VW1	6020113
				Cable with connector M8, 3-pin, 0.2 m, PVC	Cd-002	IH04-0B8PS-VR1	6045178
			NPN	Connector M8, 3-pin	Cd-002	IH04-0B8NS-VT1	6020152
				Cable, 3-wire, 2 m, PVC	Cd-001	IH04-0B8NS-VW1	6020149

Dimensional drawings (Dimensions in mm (inch))

Standard-body, flush, connector

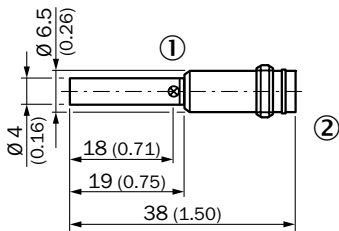

- ① Connection
- ② Display LED

Standard-body, flush, cable

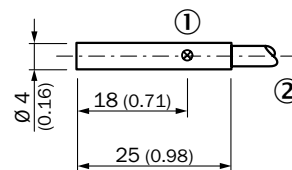

- ① Connection
- ② Display LED

Standard-body, non-flush, cable with connector, with knurled nuts

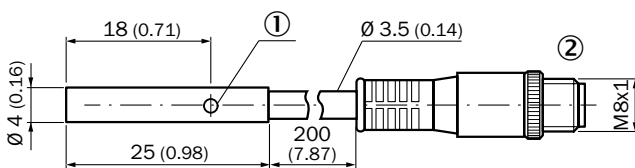

- ① Display LED
- ② Connection

Connection diagram

Cd-002

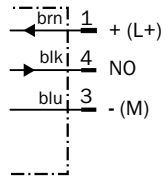

Cd-001

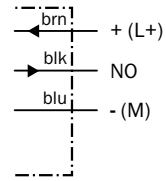

Installation note

Flush installation

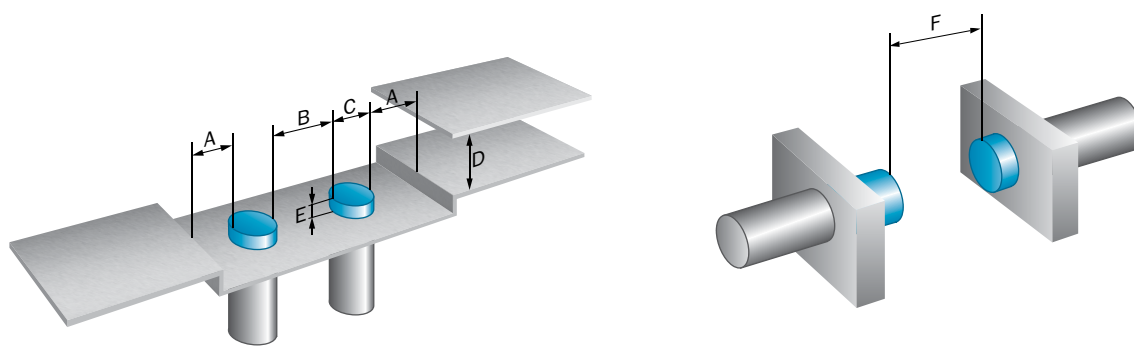

Installation note

	Installation type	Sensing range S_n	A	B	C	D	E	F
IH04 standard body	Flush	0.8 mm	0 mm	0 mm	4 mm	2.4 mm	0 mm	7 mm

SMALL SENSOR FOR HIGHLY DYNAMIC APPLICATIONS

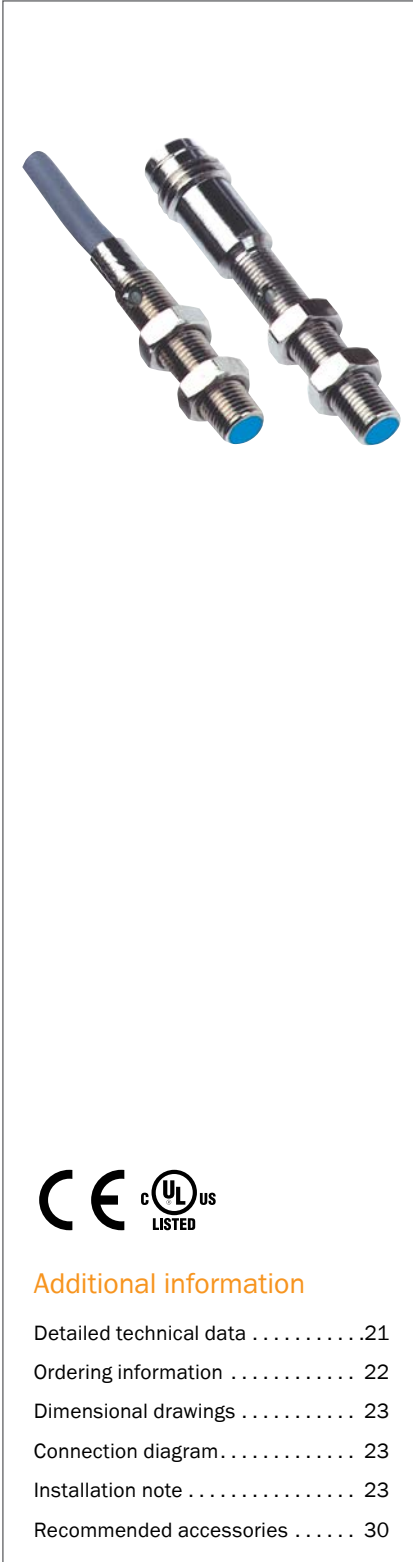

Additional information

Detailed technical data	21
Ordering information	22
Dimensional drawings	23
Connection diagram	23
Installation note	23
Recommended accessories	30

Product description

With sensing ranges of up to 1.5 mm, the IM05 inductive proximity sensor is extremely space-saving, compact, lightweight, and powerful. Modern ASIC technology guarantees a full range of services in the smallest dimensions, allowing for easy integration into compact

housings and applications. With switching frequencies of up to 5 kHz, it copes with the quick assembly and handling processes with ease. What's more, the IM05 proves to be impressive in highly dynamic applications thanks to its lightweight design.

At a glance

- Type: M5
- Large sensing range: up to 1.5 mm for flush installation
- Electrical configuration: DC, 3-wire
- Temperature range: -25 °C to 70 °C
- Rugged stainless-steel housing, sensing face made of plastic
- Extremely compact, lightweight, and space-saving
- Integrated amplifier, suppressor, and LED display

Your benefits

- Easy installation in applications with limited available space
- Reliable detection of fast handling and assembly processes
- High positioning accuracy and precise switching behavior
- Great freedom with respect to machine design
- The low weight of the sensor enables fast acceleration in dynamic handling processes

→ www.mysick.com/en/IM05

For more information, just enter the link or scan the QR code and get direct access to technical data, CAD design models, operating instructions, software, application examples and much more.



Detailed technical data

Features

	Standard-body	Standard-body
Housing	Cylindrical	
Thread size	M5 x 0.5	
Sensing range S_n	0.8 mm	1.5 mm
Assured sensing range S_a	0.648 mm	1.215 mm
Installation type	Flush	
Switching frequency	5,000 Hz	3,000 Hz
Output type	PNP / NPN (depending on type)	
Output function	NC / NO (depending on type)	
Electrical wiring	DC 3-wire	
Enclosure rating ¹⁾	IP 67	

¹⁾ According to EN 60529.

Mechanics/electronics

	Standard-body	Standard-body
Supply voltage	10 V DC ... 30 V DC	
Ripple ¹⁾	≤ 20 %	
Voltage drop ²⁾	≤ 2 V	
Current consumption ³⁾	≤ 10 mA	
Time delay before availability	≤ 10 ms	
Hysteresis	1 % ... 10 %	
Repeatability ⁴⁾	≤ 1.5 %	≤ 2 %
Temperature drift (of S_n)	≤ 10 %	
EMC	EN 60947-5-2 IEC 61000-4-2: (Testlevel 2) IEC 61000-4-4: (Testlevel 2)	EN 60947-5-2 IEC 61000-4-2: (Testlevel 2) IEC 61000-4-4: (Testlevel 3)
Connection type	Male connector, M8 Cable, 2 m, PVC Cable, 5 m, PUR (depending on type)	Cable, 2 m, PUR Male connector, M8 (depending on type)
Short-circuit protection	✓	
Reverse polarity protection	✓	
Shock and vibration resistance	30 g, 11 ms / 10 ... 55 Hz, 1 mm	
Ambient operating temperature	-25 °C ... +70 °C	
Housing material	Stainless steel (V2A, 304)	
Sensing face material	Plastic, PA66	
Tightening torque, max.	1.5 Nm	≤ 1.8 Nm
UL File No.	NRKH.E191603	

¹⁾ Of V_S .

²⁾ With $I_a = 200$ mA.

³⁾ Without load.

⁴⁾ $U_b = 20$ V DC ... 30 V DC, $T_a = 23$ °C ± 5 °C.

Reduction factors

	Standard-body	Standard-body
Note	The values are reference values which may vary	
Stainless steel (V2A, 304)	Approx. 0.8	Approx. 0.75
Aluminum (Al)	Approx. 0.5	Approx. 0.4
Copper (Cu)	Approx. 0.45	Approx. 0.4
Brass (Br)	Approx. 0.55	Approx. 0.5

Ordering information

 Other models → www.mysick.com/en/IM05

Standard-body

- **Housing:** M5 x 0.5

Installation type	Sensing range S_n	Output function	Output type	Connection	Connection diagram	Type	Part no.
Flush	0.8 mm	NC	PNP	Connector M8, 3-pin	Cd-004	IM05-0B8PO-ZT1	6020159
			NPN	Cable, 3-wire, 2 m, PVC	Cd-003	IM05-0B8NO-ZW1	6020157
		NO	PNP	Connector M8, 3-pin	Cd-002	IM05-0B8PS-ZT1	6020110
				Cable, 3-wire, 2 m, PVC	Cd-001	IM05-0B8PS-ZW1	6011591
			NPN	Cable, 3-wire, 5 m, PUR	Cd-001	IM05-0B8PS-ZWB	6021575
				Connector M8, 3-pin	Cd-002	IM05-0B8NS-ZT1	6020158
				Cable, 3-wire, 2 m, PVC	Cd-001	IM05-0B8NS-ZW1	6020155

Standard-body 1.5 mm

- **Housing:** M5 x 0.5

Installation type	Sensing range S_n	Output function	Output type	Connection	Connection diagram	Type	Part no.
Flush	1.5 mm	NC	PNP	Cable, 3-wire, 2 m, PUR	Cd-003	IM05-1B5POVU2S	6049736
				Connector M8, 3-pin	Cd-004	IM05-1B5POVT0S	6049740
			NPN	Connector M8, 3-pin	Cd-004	IM05-1B5NOVT0S	6049738
				Cable, 3-wire, 2 m, PUR	Cd-003	IM05-1B5NOVU2S	6049734
		NO	PNP	Connector M8, 3-pin	Cd-002	IM05-1B5PSVT0S	6049739
				Cable, 3-wire, 2 m, PUR	Cd-001	IM05-1B5PSVU2S	6049735
			NPN	Connector M8, 3-pin	Cd-002	IM05-1B5SVT0S	6049737
				Cable, 3-wire, 2 m, PUR	Cd-001	IM05-1B5NSVU2S	6049733

Dimensional drawings (Dimensions in mm (inch))

Standard-body, flush, connector

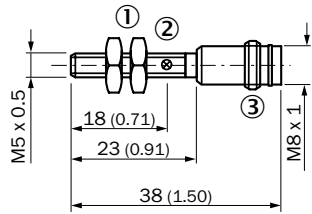

- ① Connection
- ② Display LED
- ③ Fastening nuts (2 x); 7 mm hex, stainless steel

Standard-body, flush, cable

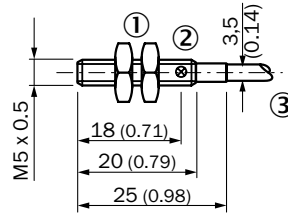

- ① Connection
- ② Display LED
- ③ Fastening nuts (2 x); 7 mm hex, stainless steel

Connection diagram

Cd-004

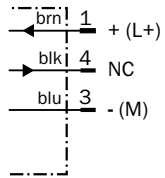

Cd-003

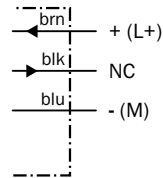

Cd-002

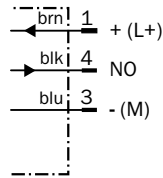

Cd-001

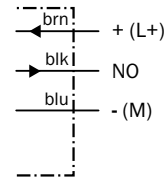

Installation note

Flush installation

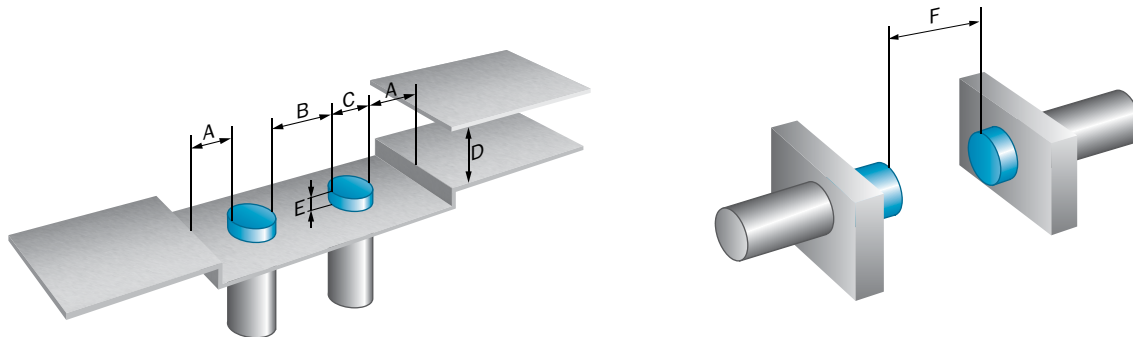

Installation note

	Installation type	Sensing range Sn	A	B	C	D	E	F
IM05-0B8xxxx	Flush	0.8 mm	0.8 mm	0 mm	5 mm	2.4 mm	0 mm	7 mm
IM05-1B5xxxx	Flush	1.5 mm	1.5 mm	0 mm	5 mm	4.5 mm	0 mm	12 mm

COMPACT, ECONOMICAL, AND POWERFUL



Product description

The rugged and reliable IH06 inductive proximity sensor is highly economical while requiring very little space. With its small dimensions and quick response times, this inductive miniature sensor measuring 6.5 mm in diameter is ideally suited to numerous applications in robotics, in handling and assembly

processes, and in mechanical engineering in general. The IH06 represents miniaturization without compromise and without sacrificing maximum performance. It boasts sensing ranges of up to 4 mm, an integrated suppressor, and rugged stainless-steel housing.

At a glance

- Type, diameter: 6.5 mm
- Increased sensing range: up to 4 mm for non-flush installation of the sensor
- Electrical configuration: DC, 3-wire
- Temperature range: -25 °C to 70 °C
- Rugged stainless-steel housing, sensing face made of plastic
- Extremely compact, lightweight, and space-saving
- Integrated amplifier, suppressor, and LED display

Your benefits

- Easy installation in applications with limited available space while offering great freedom with respect to machine design
- Reliable detection of fast handling and assembly processes
- High positioning accuracy and precise switching behavior
- Compact design – great performance
- High resistance to shock and vibrations increases service life and reduces maintenance



Additional information

Detailed technical data	25
Ordering information	26
Dimensional drawings	27
Connection diagram	28
Installation note	29
Recommended accessories	30

→ www.mysick.com/en/IH06

For more information, just enter the link or scan the QR code and get direct access to technical data, CAD design models, operating instructions, software, application examples and much more.



Detailed technical data

Features

	Ultrashort	Short-body	Standard-body
Housing	Cylindrical		
Diameter	Ø 6.5 mm		
Sensing range S_n			
Flush	1.5 mm	2 mm	
Non-flush	-	4 mm	
Assured sensing range S_a			
Flush	1.215 mm	1.62 mm	
Non-flush	-	3.24 mm	
Installation type	Flush	Flush / non-flush (depending on type)	
Switching frequency			
Flush	5,000 Hz	3,000 Hz	5,000 Hz
Non-flush	-	2,500 Hz	1,800 Hz
Output type	PNP / NPN (depending on type)		
Output function	NC / NO (depending on type)		
Electrical wiring	DC 3-wire		
Enclosure rating ¹⁾	IP 67		

¹⁾ According to EN 60529.

Mechanics/electronics

	Ultrashort	Short-body	Standard-body
Supply voltage	10 V DC ... 30 V DC		
Ripple ¹⁾	≤ 20 %	≤ 10 %	
Voltage drop ²⁾	≤ 2 V		
Current consumption	≤ 10 mA		
Time delay before availability	≤ 10 ms	≤ 50 ms	
Hysteresis	1 % ... 10 %	1 % ... 20 %	
Repeatability	≤ 1.5 % ⁴⁾	≤ 5 % ^{4) 5)}	≤ 5 % ^{4) 5)} ≤ 2 % ⁴⁾ (depending on type)
Temperature drift (of S_n)	± 10 %		
EMC	EN 60947-5-2 IEC 61000-4-2: (Testlevel 2) IEC 61000-4-4: (Testlevel 3)		
Continuous current I_a	≤ 200 mA		
Connection type	Cable, 2 m, PVC Male connector, M8, (depending on type)		
Short-circuit protection	✓		
Reverse polarity protection	✓		
Power-up pulse protection	-	✓	✓ / - (depending on type)
Shock and vibration resistance	30 g, 11 ms / 10 ... 55 Hz, 1 mm		
Ambient operating temperature	-25 °C ... +70 °C		
Housing material	Stainless steel (V2A, 304)		
Sensing face material	Plastic, PA66	Plastic, PBT	
UL File No.	NRKH.E191603	NMFT2.E175606	

¹⁾ Of V_s.

²⁾ With I_a = 200 mA.

³⁾ Without load.

⁴⁾ U_b = 20 V DC ... 30 V DC, T_a = 23 °C ± 5 °C.

⁵⁾ Of S_r.

Reduction factors

		Ultrashort	Short-body	Standard-body
Note	The values are reference values which may vary			
Stainless steel (V2A, 304)	Flush	Approx. 0.8	Approx. 0.6	Approx. 0.6
	Non-flush	–	Approx. 0.77	Approx. 0.77
Aluminum (Al)	Flush	Approx. 0.45	Approx. 0.17	Approx. 0.17
	Non-flush	–	Approx. 0.47	Approx. 0.47
Copper (Cu)	Flush	Approx. 0.4	Approx. 0.1	Approx. 0.1
	Non-flush	–	Approx. 0.42	Approx. 0.42
Brass (Br)	Flush	Approx. 0.5	Approx. 0.25	Approx. 0.25
	Non-flush	–	Approx. 0.52	Approx. 0.52

Ordering information

Other models → www.mysick.com/en/IH06

Ultrashort

- **Housing:** Ø 6.5 mm

Installation type	Sensing range S_n	Output function	Output type	Connection	Connection diagram	Type	Part no.
Flush	1.5 mm	NC	PNP	Cable, 3-wire, 2 m, PVC	Cd-003	IH06-1B5PO-VWK	6020167
				Connector M8, 3-pin	Cd-004	IH06-1B5PO-VTK	6020171
		NO	PNP	Connector M8, 3-pin	Cd-002	IH06-1B5PS-VTK	6020169
				Cable, 3-wire, 2 m, PVC	Cd-001	IH06-1B5PS-VWK	6020165
				Cable, 3-wire, 2 m, PVC	Cd-001	IH06-1B5NS-VWK	6020166
				Connector M8, 3-pin	Cd-002	IH06-1B5NS-VTK	6020170

Short-body

- **Housing:** Ø 6.5 mm

Installation type	Sensing range S_n	Output function	Output type	Connection	Connection diagram	Type	Part no.
Flush	2 mm	NC	PNP	Connector M8, 3-pin	Cd-004	IH06-02BPO-VTK	6025879
				Connector M8, 3-pin	Cd-002	IH06-02BPS-VTK	6025877
		NO	PNP	Cable, 3-wire, 2 m, PVC	Cd-001	IH06-02BPS-VWK	6025874
				Cable, 3-wire, 2 m, PVC	Cd-001	IH06-02BNS-VWK	6025875
				Connector M8, 3-pin	Cd-002	IH06-02BNS-VTK	6025878
Non-flush	4 mm	NC	PNP	Connector M8, 3-pin	Cd-004	IH06-04NPO-VTK	6025884
				Connector M8, 3-pin	Cd-002	IH06-04NPS-VTK	6025882
		NO	PNP	Cable, 3-wire, 2 m, PVC	Cd-001	IH06-04NPS-VWK	6025880
				Cable, 3-wire, 2 m, PVC	Cd-001	IH06-04NNS-VWK	6025881
				Connector M8, 3-pin	Cd-002	IH06-04NNS-VTK	6025883

Standard-body

- **Housing:** Ø 6.5 mm

Installation type	Sensing range S_0	Output function	Output type	Connection	Connection diagram	Type	Part no.
Flush	2 mm	NC	PNP	Connector M8, 3-pin	Cd-004	IH06-02BPO-VT1	1016857
			PNP	Connector M8, 3-pin	Cd-002	IH06-02BPS-VT1	7900179
		NO	PNP	Cable, 3-wire, 2 m, PVC	Cd-001	IH06-02BPS-VTQ	6025690
				Cable, 3-wire, 2 m, PVC	Cd-001	IH06-02BPS-VW1	7900177
			NPN	Cable, 3-wire, 2 m, PVC	Cd-001	IH06-02BNS-VW1	7900178
				Connector M8, 3-pin	Cd-002	IH06-02BNS-VT1	7900180
Non-flush	4 mm	NO	PNP	Connector M8, 3-pin	Cd-002	IH06-04NPS-VT1	7900183
				Cable, 3-wire, 2 m, PVC	Cd-001	IH06-04NPS-VW1	7900181
			NPN	Cable, 3-wire, 2 m, PVC	Cd-001	IH06-04NNS-VW1	7900182

Dimensional drawings (Dimensions in mm (inch))

Ultrashort, flush, cable

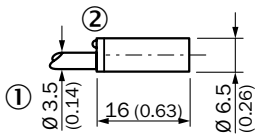

- ① Connection
- ② Display LED

Ultrashort, flush, with connector

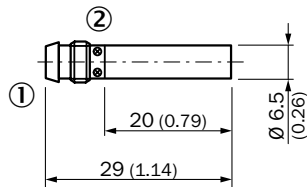

- ① Connection
- ② Display LED

Short-body, flush, connector

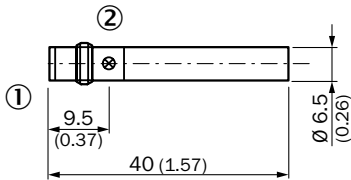

- ① Connection
- ② Display LED

Short-body, flush, cable

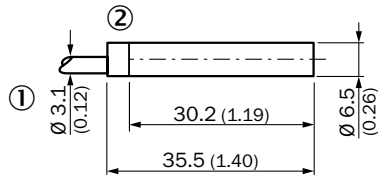

- ① Connection
- ② Display LED

Short-body, non-flush, connector

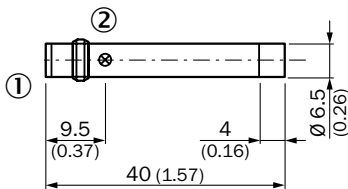

- ① Connection
- ② Display LED

Short-body, non-flush, cable

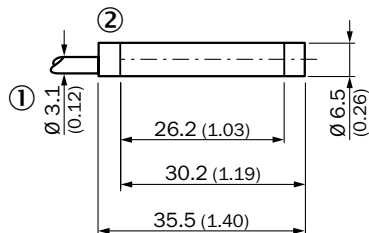

- ① Connection
- ② Display LED

Standard-body, flush, connector

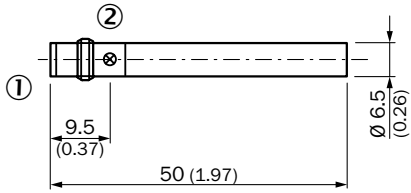

- ① Connection
- ② Display LED

Standard-body, flush, cable

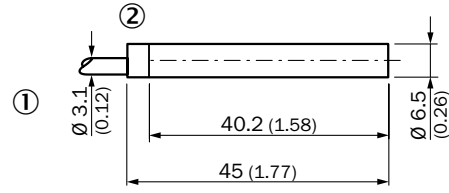

- ① Connection
- ② Display LED

Standard-body, non-flush, connector

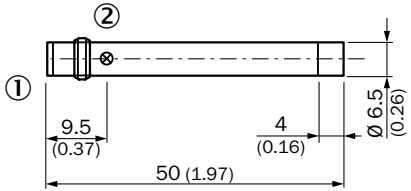

- ① Connection
- ② Display LED

Standard-body, non-flush, cable

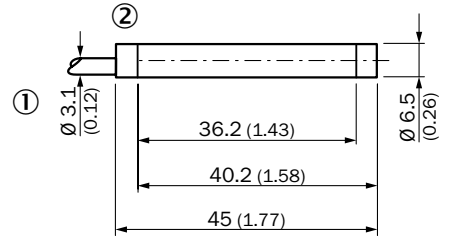

- ① Connection
- ② Display LED

Connection diagram

Cd-003

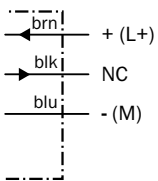

Cd-004

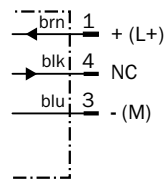

Cd-002

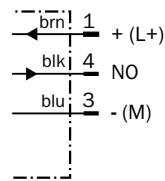

Cd-001

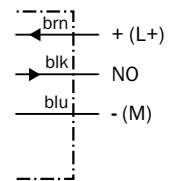

Installation note

Flush installation

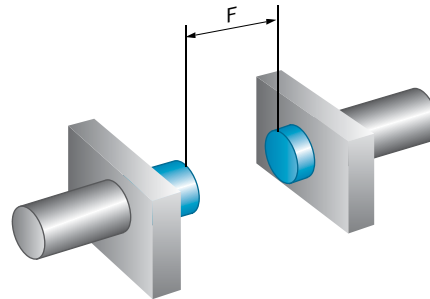
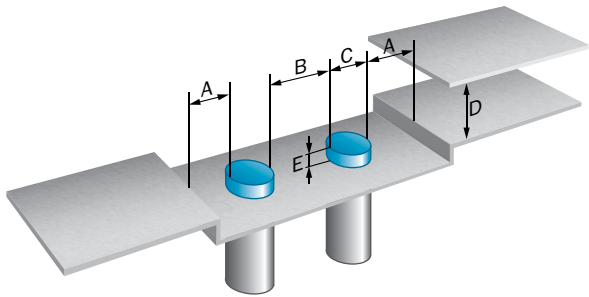

Non flush installation

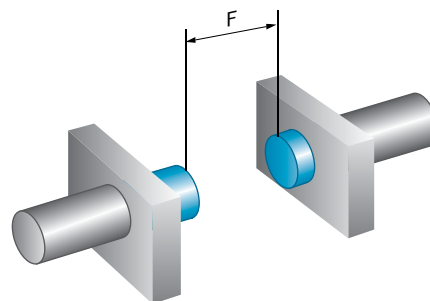
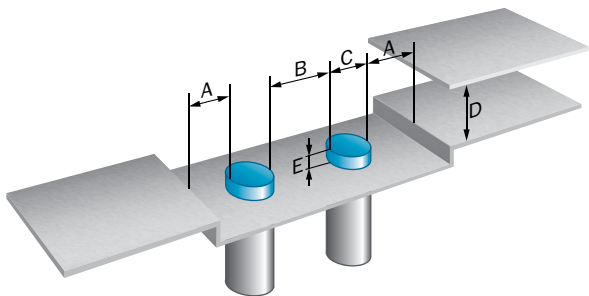

Installation note



	Installation type	Sensing range Sn	A	B	C	D	E	F
IH06 ultrashort	Flush	1.5 mm	1.75 mm	3 mm	6.5 mm	4.5 mm	0 mm	12 mm
IH06 short body	Flush	2 mm	3.25 mm	6.5 mm	6.5 mm	6 mm	4 mm	16 mm
IH06 short body	Non flush	4 mm	6.5 mm	13 mm	6.5 mm	12 mm	6 mm	32 mm
IH06 standard body	Flush	2 mm	3.25 mm	6.5 mm	6.5 mm	6 mm	4 mm	16 mm
IH06 standard body	Non flush	4 mm	6.5 mm	13 mm	6.5 mm	12 mm	6 mm	32 mm

Recommended accessories
Connection systems

Plug connectors and cables



Connecting cables with female connector M8, 3-pin, PUR, halogen-free, Oil / grease resistant

- **Cable material:** PUR, halogen-free
- **Connector material:** TPU

Figure	Connection type head A	Connection type head B	Connecting cable	Type	Part no.
	Female connector, M8, 3-pin, straight, unshielded	Cable, open conductor heads	2 m, 3-wire	DOL-0803-G02MC	6025888
			5 m, 3-wire	DOL-0803-G05MC	6025889
			10 m, 3-wire	DOL-0803-G10MC	6025890
	Female connector, M8, 3-pin, angled, unshielded	Cable, open conductor heads	2 m, 3-wire	DOL-0803-W02MC	6025891
			5 m, 3-wire	DOL-0803-W05MC	6025892
			10 m, 3-wire	DOL-0803-W10MC	6025893



Connecting cables with female connector M8, 3-pin, PVC, chemical resistant

- **Cable material:** PVC
- **Connector material:** TPU



Figure	Connection type head A	Connection type head B	Connecting cable	Type	Part no.
	Female connector, M8, 3-pin, straight, unshielded	Cable, open conductor heads	2 m, 3-wire	DOL-0803-G02M	6010785
			5 m, 3-wire	DOL-0803-G05M	6022009
			10 m, 3-wire	DOL-0803-G10M	6022011
	Female connector, M8, 3-pin, angled, unshielded	Cable, open conductor heads	2 m, 3-wire	DOL-0803-W02M	6008489
			5 m, 3-wire	DOL-0803-W05M	6022010
			10 m, 3-wire	DOL-0803-W10M	6022012

Connection cables with female connector and male connector M8, 3-pin, PUR, halogen-free, Oil / grease resistant

- **Cable material:** PUR, halogen-free
- **Connector material:** TPU

Figure	Connection type head A	Connection type head B	Connecting cable	Type	Part no.
	Female connector, M8, 3-pin, straight, unshielded	Male connector, M8, 3-pin, straight	2 m, 3-wire	DSL-0803-G02MC	6029406
			5 m, 3-wire	DSL-0803-G05MC	6032730
	Female connector, M8, 3-pin, straight, unshielded	Male connector, M12, 3-pin, straight	2 m, 3-wire	DSL-8203-G02MC	6025915
			5 m, 3-wire	DSL-8203-G05MC	6030608

Female connectors (ready to assemble) M8, 3-pin

Figure	Connection type head A	Connection type head B	Connector material	Type	Part no.
	Female connector, M8, 3-pin, straight, unshielded	Screw-type terminals	PBT/PA	DOS-0803-G	7902077
	Female connector, M8, 3-pin, angled, unshielded	Solder connection	PA/Zinc diecast	DOS-0803-W	7902078

Male connectors (ready to assemble) M8, 3-pin

Figure	Connection type head A	Connection type head B	Connector material	Type	Part no.
	Male connector, M8, 3-pin, straight, unshielded	Screw-type terminals	PBT/PA	STE-0803-G	6037322

Dimensional drawings for accessories (Dimensions in mm (inch))

Plug connectors and cables

DOL-0803-GxxMC

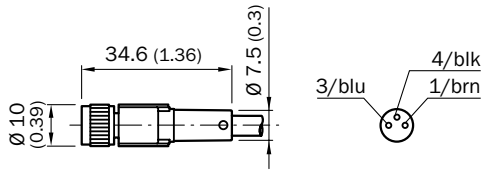

DOL-0803-W02MC

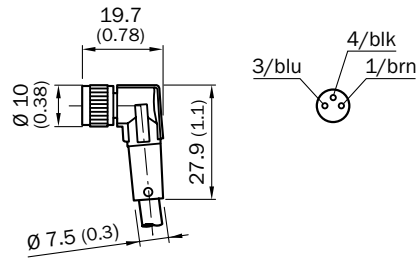

DOL-0803-G02M

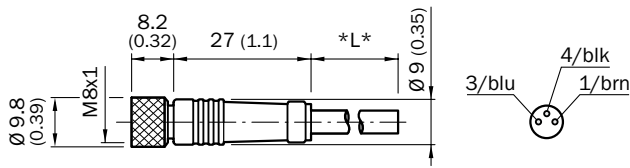

DOL-0803-W02M

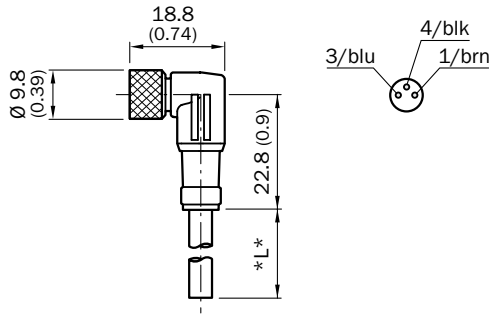

DSL-0803-GxxMC

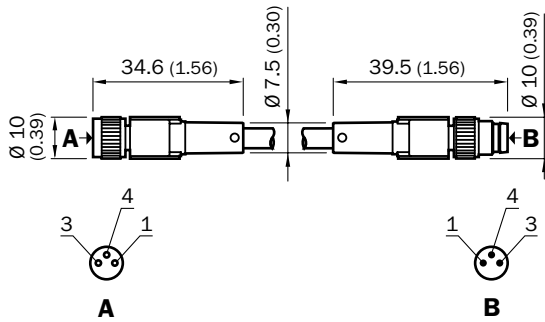

DSL-8203-GxxMC

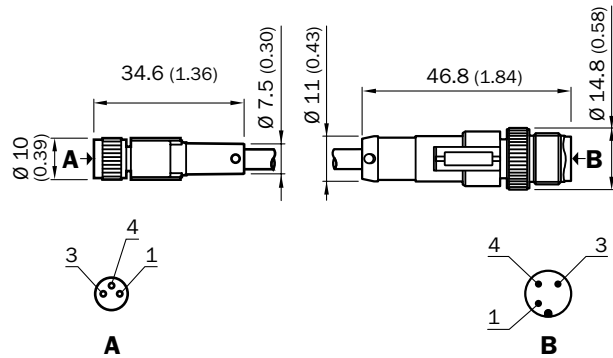

DOS-0803-G

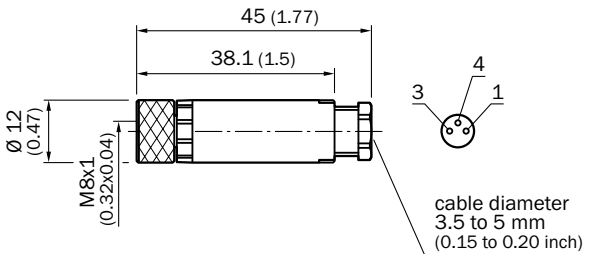

DOS-0803-W

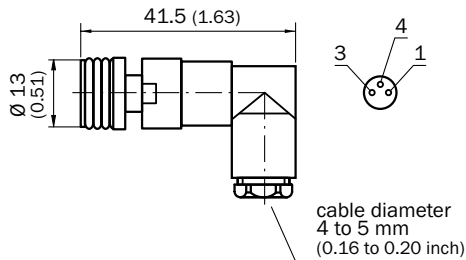

STE-0803-G

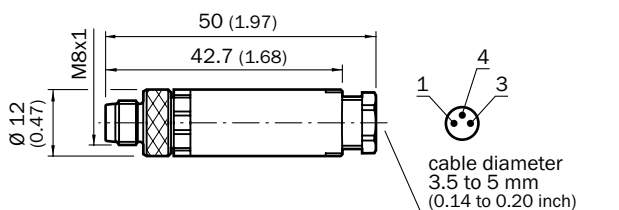

REGISTER AT WWW.SICK.COM TODAY AND ENJOY ALL THE BENEFITS





- ✔ Select products, accessories, documentation and software quickly and easily.
- ✔ Create, save and share personalized wish lists.
- ✔ View the net price and date of delivery for every product.
- ✔ Requests for quotation, ordering and delivery tracking made easy.
- ✔ Overview of all quotations and orders.
- ✔ Direct ordering: submit even very complex orders in moments.
- ✔ View the status of quotations and orders at any time. Receive e-mail notifications of status changes.
- ✔ Easily repeat previous orders.
- ✔ Conveniently export quotations and orders to work with your systems.



SERVICES FOR MACHINES AND SYSTEMS: SICK LifeTime Services

Our comprehensive and versatile LifeTime Services are the perfect addition to the comprehensive range of products from SICK. The services range from product-independent consulting to traditional product services.



- 
Consulting and design
 Safe and professional
- 
Product and system support
 Reliable, fast and on-site
- 
Verification and optimization
 Safe and regularly inspected
- 
Upgrade and retrofits
 Easy, safe and economical
- 
Training and education
 Practical, focused and professional

SICK AT A GLANCE

SICK is a leading manufacturer of intelligent sensors and sensor solutions for industrial applications. With almost 7,000 employees and over 50 subsidiaries and equity investments as well as numerous representative offices worldwide, we are always close to our customers. A unique range of products and services creates the perfect basis for controlling processes securely and efficiently, protecting individuals from accidents and preventing damage to the environment.

We have extensive experience in various industries and understand their processes and requirements. With intelligent sensors, we can deliver exactly what our customers need. In application centers in Europe, Asia and North America, system solutions are tested and optimized in accordance with customer specifications. All this makes us a reliable supplier and development partner.

Comprehensive services round out our offering: SICK LifeTime Services provide support throughout the machine life cycle and ensure safety and productivity.

For us, that is “Sensor Intelligence.”

Worldwide presence:

Australia, Austria, Belgium, Brazil, Canada, Chile, China, Czech Republic, Denmark, Finland, France, Germany, Great Britain, Hungary, India, Israel, Italy, Japan, Malaysia, Mexico, Netherlands, New Zealand, Norway, Poland, Romania, Russia, Singapore, Slovakia, Slovenia, South Africa, South Korea, Spain, Sweden, Switzerland, Taiwan, Thailand, Turkey, United Arab Emirates, USA, Vietnam.

Detailed addresses and additional representatives → www.sick.com

X-ON Electronics

Largest Supplier of Electrical and Electronic Components

Click to view similar products for [Proximity Sensors](#) category:

Click to view products by [Sick](#) manufacturer:

Other Similar products are found below :

[01.001.5653.1](#) [70.340.1028.0](#) [70.360.2428.0](#) [70.364.4828.0](#) [70.810.1053.0](#) [72.360.1628.0](#) [73.363.6428.0](#) [9221350022](#) [980659-1](#) [QT-12](#)
[E2EX10D1NN](#) [E2E-X14MD1-G](#) [E2E-X2D1-G](#) [E2EX2ME2N](#) [E2E-X3D1-N](#) [10M](#) [E2E-X4MD1-G](#) [E2FMX1R5D12M](#) [E2K-F10MC1](#) [5M](#)
[EI1204TBOSL-6](#) [EI5515NPAP](#) [BSA-08-25-08](#) [IC08ANC15PO-K](#) [IMM2582C](#) [25.161.3253.0](#) [25.332.0653.1](#) [25.352.0653.0](#) [25.352.0753.0](#)
[25.523.3253.0](#) [9151710023](#) [922FS1.5C-A4P-Z774](#) [SC606ABV0S30](#) [SM952A126100LE](#) [SM956A132600](#) [A1220EUA-T](#) [F3S-A162-U](#) [CL18](#)
[QT-08L](#) [34.110.0010.0](#) [TL-C2MF1-M3-E4](#) [IA08BLF15NOM5](#) [IA08BSF15NOM5](#) [IA12ASF04DOM1](#) [IMM32188C](#) [IS2](#) [IS31SE5000-](#)
[UTLS2-TR](#) [34.110.0021.0](#) [34.110.0022.0](#) [CA150-120VACDC](#) [VM18VA3000Q](#) [XS508BSCBL2](#)