

## Overview

## More information

Homepage, see [www.siemens.com/solid-state-switching-devices](http://www.siemens.com/solid-state-switching-devices)  
 Industry Mall, see [www.siemens.com/product?3RF](http://www.siemens.com/product?3RF)

Online configurator, see [www.siemens.com/sirius/configurators](http://www.siemens.com/sirius/configurators)

## SIRIUS 3RF solid-state switching devices



Three-phase solid-state contactor and single-phase solid-state relay

The SIRIUS 3RF2 solid-state switching devices reliably switch a wide range of different loads with alternating voltages in 50 and 60 Hz systems.

SIRIUS 3RF2 solid-state switching devices for resistive/inductive loads:

- Solid-state relays
- Solid state contactors
- Function modules

SIRIUS 3RF2 – for almost unending activity

Conventional electromechanical switchgear is often overtaxed by the rise in the number of switching operations. A high switching frequency results in frequent failure and short replacement cycles. However, this does not have to be the case, because with the latest generation of our SIRIUS 3RF2 solid-state switching devices we provide you with solid-state relays and contactors with a particularly long endurance – for almost unending activity even under the toughest conditions and under high mechanical load, but also in noise-sensitive areas.

Proven time and again in service

SIRIUS 3RF2 solid-state switching devices have firmly established themselves in industrial applications. They are used above all in applications where loads are switched frequently – mainly with resistive load controllers, with the control of electrical heat or the control of valves and motors in conveyor systems. In addition to its use in areas with high switching frequencies, their silent switching means that SIRIUS is also ideally suited for use in noise-sensitive areas, such as offices or hospitals.

The most reliable solution for any application

Compared to mechanical controlgear, our SIRIUS 3RF2 solid-state switching devices stand out due to their considerably longer service life. Thanks to the high product quality, their switching is extremely precise, reliable and, above all, insusceptible to faults. With its variable connection methods and a wide spread of control voltages, the SIRIUS 3RF2 family is universally applicable. Depending on the individual requirements of the application, our modular controlgear can also be quite easily expanded by the addition of standardized function modules.

Always on the sunny side with SIRIUS

Because SIRIUS 3RF2 offers even more:

- The space-saving and compact side-by-side mounting ensures reliable operation up to an ambient temperature of +60 °C.
- Thanks to fast configuration and the ease of mounting and start up, you save not only time but also expenses.

Also for switching motors (see page 6/104)



In order to achieve higher productivity, the switching frequency is continuously increased. It is no problem for our SIRIUS solid-state contactors to switch motors. With induction motors up to 7.5 kW, they can reliably withstand even the highest switching frequencies. Even a continuous change in the direction of rotation is possible with the solid-state reversing contactors. Both versions can be perfectly combined with components from the SIRIUS modular system. Connecting with SIRIUS motor starter protectors or SIRIUS overload relays can be implemented without any further steps.

SIRIUS 3RF3 solid-state switching devices for switching motors:

- Solid state contactors
- Solid-state reversing contactors

**Connection methods**

The solid-state switching devices are available with screw terminals (box terminals), spring-type terminals or ring terminal lugs.

-  Screw terminals
-  Spring-type terminals
-  Ring terminal lug connection

The terminals are indicated in the corresponding tables by the symbols shown on orange backgrounds.

## Solid-State Switching Devices for Resistive/Inductive Loads

### General data

#### Online Configurator

- Simple selection of individual solid-state switching devices by means of technical characteristics (e.g. zero-point switching, spring-type terminal and rated current)
- Once configuration is complete, you receive the article numbers corresponding to the products

see [www.siemens.com/sirius/configurators](http://www.siemens.com/sirius/configurators)

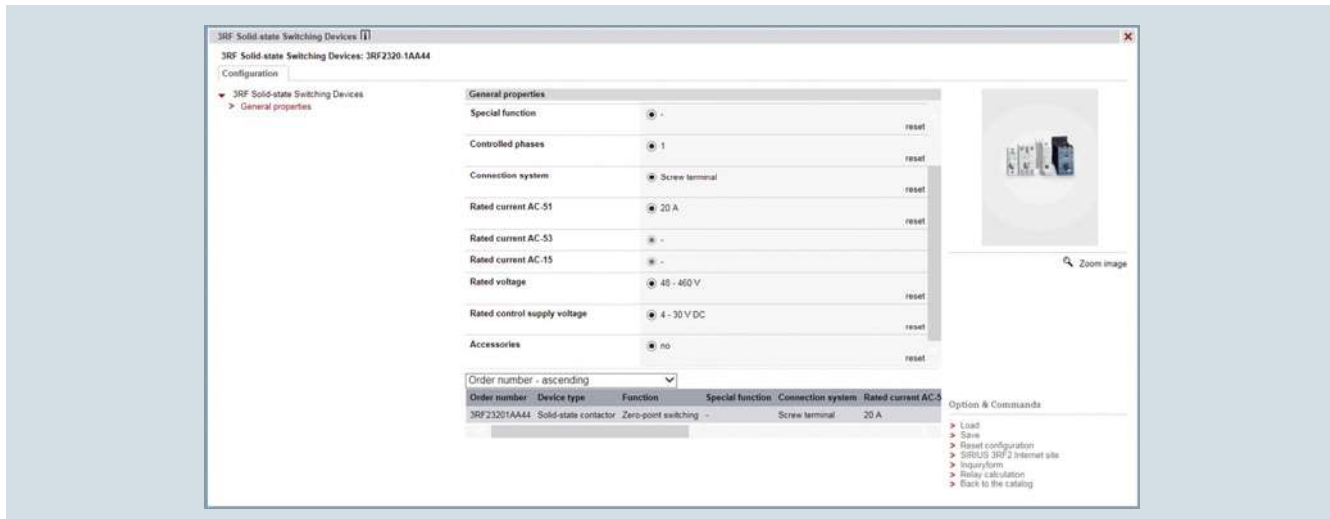

#### Article No. scheme

Product versions		Article number								
Device type	<b>Solid-state relays</b>	<b>3RF20</b>	<input type="checkbox"/>	<input type="checkbox"/>	<input type="checkbox"/>	<input type="checkbox"/>	<input type="checkbox"/>	Single-phase, 45-mm width		
		<b>3RF21</b>	<input type="checkbox"/>	<input type="checkbox"/>	<input type="checkbox"/>	<input type="checkbox"/>	<input type="checkbox"/>	Single-phase, 22.5-mm width		
		<b>3RF22</b>	<input type="checkbox"/>	<input type="checkbox"/>	<input type="checkbox"/>	<input type="checkbox"/>	<input type="checkbox"/>	Three-phase, 45-mm width		
	<b>Solid-state contactors</b>	<b>3RF23</b>	<input type="checkbox"/>	<input type="checkbox"/>	<input type="checkbox"/>	<input type="checkbox"/>	<input type="checkbox"/>	Single-phase		
		<b>3RF24</b>	<input type="checkbox"/>	<input type="checkbox"/>	<input type="checkbox"/>	<input type="checkbox"/>	<input type="checkbox"/>	Three-phase		
Type current	e.g. 20 = 20 A	<input type="checkbox"/>	<input type="checkbox"/>							
Connection type	Screw terminals						<b>1</b>			
	Spring-type terminals						<b>2</b>			
	Ring terminal lug connection						<b>3</b>			
Switching function	Zero-point switching						<b>A</b>			
	Instantaneous switching						<b>B</b>			
	Zero-point switching						<b>C</b>	Low Noise		
	Zero-point switching						<b>D</b>	Short-circuit-proof with B MCB		
Single-phase or number of controlled phases	Single-phase						<b>A</b>			
	Two-phase						<b>B</b>			
	Three-phase						<b>C</b>			
	Reversing contactor						<b>D</b>			
Rated control supply voltage $U_s$	24 V DC						<b>0</b>			
	24 V AC/DC						<b>1</b>			
	110 ... 230 V AC						<b>2</b>			
	110 V AC						<b>3</b>			
	4 ... 30 V DC						<b>4</b>			
Rated operational voltage $U_e$	230 V AC						<b>5</b>			
	24 ... 230 V AC						<b>2</b>			
	48 ... 460 V AC						<b>4</b>			
	48 ... 600 V AC						<b>5</b>			
	48 ... 600 V AC						<b>6</b>	Blocking voltage 1 600 V		
Example		<b>3RF21</b>	<b>2</b>	<b>0</b>	<b>-</b>	<b>1</b>	<b>A</b>	<b>A</b>	<b>0</b>	<b>6</b>

#### Note:

The Article No. scheme shows an overview of product versions for better understanding of the logic behind the article numbers.

For your orders please use the article numbers quoted in the selection and ordering data.

## Solid-State Switching Devices for Resistive/Inductive Loads

General data

## Overview of the SIRIUS 3RF2 solid-state switching devices

Type	Solid-state relays			Solid-state contactors		Function modules					
	Single-phase		3-phase	Single-phase	3-phase	Converters	Load monitoring		Heating current monitoring	Power controllers	Power regulators
	22.5 mm	45 mm	45 mm				Basic	Extended			
<b>Usage</b>											
Simple use of existing solid-state relays	<input type="checkbox"/>	<input checked="" type="checkbox"/>	<input type="checkbox"/>	<input type="checkbox"/>	<input type="checkbox"/>	--	--	--	--	--	--
Complete unit "Ready to use"	<input type="checkbox"/>	<input type="checkbox"/>	<input type="checkbox"/>	<input checked="" type="checkbox"/>	<input checked="" type="checkbox"/>	--	--	--	--	--	--
Space-saving	<input checked="" type="checkbox"/>	--	<input checked="" type="checkbox"/>	<input checked="" type="checkbox"/>	<input checked="" type="checkbox"/>	<input checked="" type="checkbox"/>	<input checked="" type="checkbox"/>	--	--	--	--
Can be extended with modular function modules	<input checked="" type="checkbox"/>	--	1)	<input checked="" type="checkbox"/>	1)	--	--	--	--	--	--
Frequent switching and monitoring of loads and solid-state relays/solid-state contactors	--	--	--	--	--	--	<input checked="" type="checkbox"/>	<input checked="" type="checkbox"/>	<input checked="" type="checkbox"/>	<input checked="" type="checkbox"/>	<input checked="" type="checkbox"/>
Monitoring of up to 6 partial loads	--	--	--	--	--	--	<input checked="" type="checkbox"/>	--	<input checked="" type="checkbox"/>	<input checked="" type="checkbox"/>	--
Monitoring of more than 6 partial loads	--	--	--	--	--	--	--	<input checked="" type="checkbox"/>	--	--	--
Control of the heating power through an analog input	--	--	--	--	--	<input checked="" type="checkbox"/>	--	--	--	<input checked="" type="checkbox"/>	<input checked="" type="checkbox"/>
Power control	--	--	--	--	--	--	--	--	--	--	<input checked="" type="checkbox"/>
<b>Startup</b>											
Easy setting of setpoint values with "Teach" button	--	--	--	--	--	--	<input checked="" type="checkbox"/>	<input checked="" type="checkbox"/>	--	<input checked="" type="checkbox"/>	<input checked="" type="checkbox"/>
"Remote Teach" input for setting setpoints	--	--	--	--	--	--	--	--	<input checked="" type="checkbox"/>	--	--
<b>Mounting</b>											
Mounting onto mounting rails or mounting plates	--	--	--	<input checked="" type="checkbox"/>	<input checked="" type="checkbox"/>	--	--	--	--	--	--
Can be snapped directly onto a solid-state relay or contactor	--	--	--	--	--	<input checked="" type="checkbox"/>	<input checked="" type="checkbox"/>	<input checked="" type="checkbox"/>	<input checked="" type="checkbox"/>	<input checked="" type="checkbox"/>	<input checked="" type="checkbox"/>
For use with "Coolplate" heat sink	<input checked="" type="checkbox"/>	<input checked="" type="checkbox"/>	<input checked="" type="checkbox"/>	--	--	--	--	--	--	--	--
<b>Cable routing</b>											
Connection of load circuit as for controlgear	<input checked="" type="checkbox"/>	--	<input checked="" type="checkbox"/>	<input checked="" type="checkbox"/>	<input checked="" type="checkbox"/>	--	<input checked="" type="checkbox"/>	<input checked="" type="checkbox"/>	<input checked="" type="checkbox"/>	<input checked="" type="checkbox"/>	<input checked="" type="checkbox"/>
Connection of load circuit from above	--	<input checked="" type="checkbox"/>	--	--	--	--	--	--	--	--	--

- Function available
- Function possible
- Function not possible

1) The converter can also be used with three-phase devices.

## Solid-State Switching Devices for Resistive/Inductive Loads

### General data

#### Benefits

##### Features

- Considerable space savings thanks to a width of only 22.5 mm
- Variety of connection methods: Screw terminal, spring-type connection or ring terminal lug, there is no problem – they are all finger-safe
- Flexible for all applications with function modules for retrofitting
- Possibility of fuseless short-circuit proof design

##### Benefits

- Saves time and costs with fast mounting and commissioning, short start up times and easy wiring
- Extremely long life, low maintenance, rugged and reliable
- Space-saving and safe thanks to side-by-side mounting up to an ambient temperature of +60 °C
- Modular design: Standardized function modules and heat sinks can be used in conjunction with solid-state relays to satisfy individual requirements
- Safety due to lifelong, vibration-resistant and shock-resistant spring-type terminal connection method even under tough conditions

#### Application

##### Applications

###### Example: Plastics processing industry

Thanks to their high switching endurance SIRIUS 3RF2 solid-state switching devices are ideal for controlling electrical heat. This is because the more precise the temperature regulation process has to be, the higher the switching frequency. The accurate regulation of electrical heat is used for example in many processes in the plastics processing industry:

- Band heaters heat the extrudate to the correct temperature in plastic extruders
- Heat emitters heat plastic blanks to the correct temperature
- Heat drums dry plastic granules
- Heating channels keep molds at the correct temperature in order to manufacture different plastic parts without defects

The powerful SIRIUS 3RF2 solid-state relays and contactors can be used for the simultaneous control of several heating loads. By using a load monitoring module the individual partial loads can easily be monitored, and in the event of a failure a signal is generated to be sent to the controller.

###### Use in fuseless load feeders

Compared with the fused configuration of load feeders, short circuit and line protection using miniature circuit breakers is easy to achieve with SIRIUS 3RF2 solid-state relays and contactors.

A special version of the solid-state contactors can be protected against damage in the case of a short circuit with a miniature circuit breaker with type B tripping characteristic. This allows the low-cost and simple design of fuseless load feeders with full protection of the switchgear.

### Selection and ordering data

#### Inscription labels for 3RF2 series

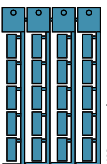
Designation	Labeling area (W x H)	Color	SD	Article No.	Price per PU	PU (UNIT, SET, M)	PS*	PG
	mm x mm		d					
<b>Blank labels</b>								
	<b>Unit labeling plates for SIRIUS<sup>1)</sup></b>	10 x 7	Pastel turquoise	15	<b>3RT1900-1SB10</b>	100	816 units	41B
		20 x 7	Pastel turquoise	20	<b>3RT1900-1SB20</b>	100	340 units	41B
	<b>Adhesive labels for SIRIUS</b>	19 x 6	Pastel turquoise	15	<b>3RT1900-1SB60</b>	100	3 060 units	41B
		19 x 6	Zinc yellow	15	<b>3RT1900-1SD60</b>	100	3 060 units	41B

3RT1900-1SB20  
(1 frame = 20 units)

<sup>1)</sup> PC labeling systems for individual inscription of unit labeling plates are available from: murrplastik Systemtechnik GmbH, see page 16/15.

**More information****Notes on integration in the load feeders**

The SIRIUS solid-state switching devices are very easy to integrate into the load feeders thanks to their industrial connection method and design.

Particular attention must however be paid to the circumstances of the installation and ambient conditions, as the performance of the solid-state switching devices is largely dependent on these. Depending on the version, certain restrictions must be observed. Detailed information in relation to solid-state contactors, e.g. on minimum spacing, and in relation to solid-state relays on the choice of heat sink can be found in the technical specifications and in the product data sheets, [see https://support.industry.siemens.com/cs/ww/en/ps/16222](https://support.industry.siemens.com/cs/ww/en/ps/16222).

**Short-circuit and overload protection**

Despite the rugged power semiconductors that are used, solid-state switching devices respond more sensitively to short circuits in the load feeder. Consequently, special precautions have to be taken against destruction, depending on the type of design.

Siemens generally recommends using SITOR semiconductor protection fuses. These fuses also provide protection against destruction in the event of a short circuit even when the solid-state contactors and solid-state relays are fully utilized.

Alternatively, if there is lower loading, protection can also be provided by standard fuses or miniature circuit breakers. This protection is achieved by overdimensioning the solid-state switching devices accordingly. The technical specifications and the product data sheets contain details both about the solid-state fuse protection itself and about use of the devices with conventional protection equipment.

**Electromagnetic compatibility (EMC)**

The solid-state switching devices are suitable for interference-free operation in industrial networks without further measures. If they are used in public networks, it may be necessary for conducted interference to be reduced by means of filters.

This does not include the solid-state contactors for resistive loads of the special type 3RF23...-CA.. "Low Noise". These comply with the class B limit values up to a rated current of 16 A. If other versions are used, and at currents of over 16 A, standard filters can be used in order to comply with the limit values. The decisive factors when it comes to selecting the filters are essentially the current loading and the other parameters (operational voltage, design type, etc.) in the load feeder.

Suitable filters can be ordered from EPCOS AG, [see page 16/15](#).

**Product information and technical specifications**

For product data sheets with detailed technical specifications, dimensional drawings and characteristic curves, [see https://support.industry.siemens.com/cs/ww/en/ps/16222](https://support.industry.siemens.com/cs/ww/en/ps/16222).

For additional information, please enter the article number of the required device under the tab "Product List".

## Solid-State Switching Devices for Resistive/Inductive Loads

### Solid-State Relays

#### General data

#### Overview

##### **Solid-state relays (without heat sink)**

SIRIUS solid-state relays are suitable for surface mounting on existing cooling surfaces. Mounting is quick and easy, involving just two screws. The special technology of the power semiconductor ensures there is excellent thermal contact with the heat sink. Depending on the nature of the heat sink, the capacity reaches up to 88 A on resistive loads.

The solid-state relays are available in three different versions:

- 3RF21 single-phase solid-state relay with a width of 22.5 mm
- 3RF20 single-phase solid-state relay with a width of 45 mm
- 3RF22 three-phase solid-state relay with a width of 45 mm

The 3RF21 and 3RF22 solid-state relays can be expanded with various function modules to adapt them to individual applications.

##### **Version for resistive loads "zero-point switching"**

This standard version is often used for switching space heaters on and off.

##### **Version for inductive loads "instantaneous switching"**

In this version the solid-state relay is specifically matched to inductive loads. Whether it is a matter of frequent actuation of the valves in a filling plant or starting and stopping small operating mechanisms in packet distribution systems, operation is carried out safely and noiselessly.

##### **Special "low noise" version**

Thanks to a special control circuit, this special version can be used in public networks up to 16 A without any additional measures such as interference suppressor filters. As a result, in terms of emitted interference, it conforms to limit value curve class B according to IEC 60947-4-3.

##### **Single-phase solid-state relays with a width of 22.5 mm**

With its compact design and a width of just 22.5 mm, which stays the same even at currents of up to 88 A, the 3RF21 solid-state relay offers an ultra small footprint. The logical connection method, with the power infeed from above and load connection from below, ensures tidy installation in the control cabinet.

##### **Single-phase solid-state relays with a width of 45 mm**

The solid-state relays with a width of 45 mm provide for connection of the power supply lead and the load from above. This makes it easy to replace existing solid-state relays in existing arrangements. The connection of the control cable is as space-saving as the 22.5 mm design, as it is simply plugged on.

##### **Three-phase solid-state relays with a width of 45 mm**

With its compact design and a width of just 45 mm, which stays the same even at currents of up to 55 A, the 3RF22 solid-state relay offers an ultra small footprint. The logical connection method, with the power infeed from above and load connection from below, ensures tidy installation in the control cabinet.

The three-phase solid-state relays are available with

- Two-phase control (suitable in particular for circuits without connection to the neutral conductor) and
- Three-phase control (suitable for star circuits with connection to the neutral conductor or for applications in which the system requires all phases to be switched)

##### **Selection notes**

When selecting solid-state relays, in addition to information about the network, the load and the ambient conditions it is also necessary to know details of the planned design. The solid-state relays can only conform to their specific technical specifications if they are mounted with appropriate care on an adequately dimensioned heat sink.

Mounting solid-state relays directly on a mounting plate made of sheet steel is inadequate in terms of heat dissipation.

The following procedure is recommended:

- Determine the rated current of the load and the mains voltage
- Select the relay design and choose a solid-state relay with higher rated current than the load
- Determine the thermal resistance of the proposed heat sink
- Check the correct relay size with the aid of the diagrams

# Solid-State Switching Devices for Resistive/Inductive Loads

## Solid-State Relays

### SIRIUS 3RF21 solid-state relays, single-phase, 22.5 mm





#### Overview

##### Single-phase solid-state relays (without heat sink) with a width of 22.5 mm

With its compact design and a width of just 22.5 mm, which stays the same even at currents of up to 88 A, the 3RF21 solid-state relay offers an ultra small footprint. The logical connection

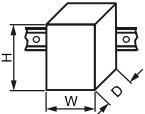
method, with the power infeed from above and load connection from below, ensures tidy installation in the control cabinet.

#### Technical specifications

More information				
System Manual "SIRIUS Modular System – System Overview", see <a href="https://support.industry.siemens.com/cs/ww/en/view/60311318">https://support.industry.siemens.com/cs/ww/en/view/60311318</a>		FAQs, see <a href="https://support.industry.siemens.com/cs/ww/en/ps/16224/faq">https://support.industry.siemens.com/cs/ww/en/ps/16224/faq</a>		
Type		<b>3RF21..-1....</b>	<b>3RF21..-2....</b>	<b>3RF21..-3....</b>
Dimensions (W x H x D)		mm 22.5 x 85 x 48 mm	22.5 x 85 x 48 mm	22.5 x 85 x 48 mm
General data				
<b>Ambient temperature</b>				
• During operation, derating from 40 °C	°C	-25 ... + 60		
• During storage	°C	-55 ... + 80		
<b>Installation altitude</b>		m	0 ... 1 000; derating from 1 000	
<b>Shock resistance</b> acc. to IEC 60068-2-27		g/ms	15/11	
<b>Vibration resistance</b> acc. to IEC 60068-2-6		g	2	
<b>Degree of protection</b>		IP20		IP00 (IP20 when using the terminal cover 3RA2900-3PA88)
<b>Electromagnetic compatibility (EMC)</b>				
• Emitted interference			Class A for industrial applications	
- Conducted interference voltage acc. to IEC 60947-4-3			Class B for residential, business and commercial applications	
- Emitted, high-frequency interference voltage acc. to IEC 60947-4-3				
• Interference immunity			Contact discharge 4; air discharge 8; behavior criterion 2	
- Electrostatic discharge acc. to IEC 61000-4-2 (corresponds to degree of severity 3)		kV		
- Induced RF fields according to IEC 61000-4-6		MHz	0.15 ... 80; 140 dBµV; behavior criterion 1	
- Burst acc. to IEC 61000-4-4		kV	2/5.0 kHz; behavior criterion 2	
- Surge acc. to IEC 61000-4-5		kV	Conductor - ground 2; conductor - conductor 1; behavior criterion 2	
<b>Mounting</b>				
• Screws (not included in the scope of supply)		Nm	2 x M4	
• Tightening torque		Nm	1.5	
<b>Connection type</b>				
<b>Connection, main contacts</b>				
• Conductor cross-sections		mm <sup>2</sup>	2 x (1.5 ... 2.5) <sup>1)</sup> , 2 x (2.5 ... 6) <sup>1)</sup>	2 x (0.5 ... 2.5)
- Solid		mm <sup>2</sup>	2 x (1 ... 2.5) <sup>1)</sup> , 2 x (2.5 ... 6) <sup>1)</sup> , 1 x 10	2 x (0.5 ... 1.5)
- Finely stranded with end sleeve		mm <sup>2</sup>	--	--
- Finely stranded without end sleeve		mm <sup>2</sup>	--	2 x (0.5 ... 2.5)
- Solid or stranded, AWG cables		AWG	2 x (14 ... 10)	2 x (18 ... 14)
• Terminal screws		M4	--	M5
• Tightening torques		Nm	2 ... 2.5	2.5 ... 2
		lb.in	7 ... 10.3	10.3 ... 7
• Cable lugs				
- According to DIN 46234		--	--	5-2.5, 5-6, 5-10, 5-16, 5-25
- According to JIS C 2805		--	--	R 2-5, R 5.5-5, R 8-5, R 14-5
- Width, maximum		mm	--	12
<b>Connection, auxiliary/control contacts</b>				
• Conductor cross-sections		mm	1 x (0.5 ... 2.5), 2 x (0.5 ... 1.0)	1 x (0.5 ... 2.5), 2 x (0.5 ... 1.0)
		AWG	20 ... 12	20 ... 12
• Stripped length		mm	7	7
• Terminal screw		M3	--	M3
• Tightening torques		Nm	0.5 ... 0.6	0.5 ... 0.6
		lb.in	4.5 ... 5.3	4.5 ... 5.3

<sup>1)</sup> If two different conductor cross-sections are connected to one clamping point, both cross-sections must lie in one of the ranges specified.

## Solid-State Switching Devices for Resistive/Inductive Loads

### Solid-State Relays

#### SIRIUS 3RF21 solid-state relays, single-phase, 22.5 mm

Type	$I_{\max}^{1)}$ at $R_{\text{thha}}/T_u = 40\text{ °C}$		$I_e$ acc. to IEC 60947-4-3 at $R_{\text{thha}}/T_u = 40\text{ °C}$		$I_e$ acc. to UL/CSA at $R_{\text{thha}}/T_u = 50\text{ °C}$		Power loss at $I_{\max}$	Minimum load current	Off-state current
	A	K/W	A	K/W	A	K/W	W	A	mA
<b>Main circuit</b>									
3RF2120-.....	20	2.0	20	1.7	20	1.3	28.6	0.1	10
3RF2130-1....	30	1.1	30	0.79	30	0.56	44.2	0.5	10
3RF2150-1....	50	0.68	50	0.48	50	0.33	66	0.5	10
3RF2150-2....	50	0.68	20	2.6	20	2.9	66	0.5	10
3RF2150-3....	50	0.68	50	0.48	50	0.33	66	0.5	10
3RF2170-1....	70	0.40	50	0.77	50	0.6	94	0.5	10
3RF2190-1....	88	0.33	50	0.94	50	0.85	118	0.5	10
3RF2190-2....	88	0.33	20	2.8	20	3.5	118	0.5	10
3RF2190-3....	88	0.33	88	0.22	83	0.19	118	0.5	10

<sup>1)</sup> The current  $I_{\max}$  provides information about the performance of the solid-state relay. The actual permitted rated operational current  $I_e$  can be smaller depending on the connection method and cooling conditions.

#### Note:

The required heat sinks for the corresponding load currents can be determined from the characteristic curves (see page 6/63, "More Information"). The minimum thickness values for the mounting surface must be observed.

Type	Rated peak withstand current $I_{\text{tsm}}$	$I^2t$ value
	A	A <sup>2</sup> s
<b>Main circuit</b>		
3RF2120-.....	200	200
3RF2130-...A.2	300	450
3RF2130-...A.4	300	450
3RF2130-...A.5	300	450
3RF2130-...A.6	400	800
3RF2150-.....	600	1 800
3RF2170-...A.2	1 200	7 200
3RF2170-...A.4	1 200	7 200
3RF2170-...A.5	1 200	7 200
3RF2170-...A.6	1 150	6 600
3RF2190-.....	1 150	6 600

Type		3RF21...-...2	3RF21...-...4	3RF21...-...5	3RF21...-...6
<b>Main circuit</b>					
Rated operational voltage $U_e$	V AC	24 ... 230	48 ... 460		
• Operating range	V AC	20 ... 253	40 ... 506	40 ... 660	
• Rated frequency	Hz	50/60 ± 10%			
Rated insulation voltage $U_i$	V	600			
Blocking voltage	V	800	1 200		1 600
Rate of voltage rise	V/μs	1 000			

Type		3RF21...-...0.	3RF21...-...1.	3RF21...-...2.	3RF21...-...4.
<b>Control circuit</b>					
Method of operation		DC operation	AC/DC operation	AC operation	DC operation
Rated control supply voltage $U_s$	V	24	24 AC 24 DC	110 ... 230	4 ... 30
Rated frequency of the control supply voltage	Hz	--	50/60 ± 10%	50/60 ± 10%	--
Control supply voltage, max.	V	30	26.5 AC 30 DC	253	30
Typical actuating current	mA	20 / Low Power: 6.5 <sup>1)</sup>	20	15	20
Response voltage	V	15	14 AC 15 DC	90	4
Drop-out voltage	V	5	5 AC 5 DC	40	1
<b>Operating times</b>					
• ON-delay	ms	1 + max. one half-wave <sup>2)</sup>	10 + max. one half-wave <sup>2)</sup>	40 + max. one half-wave <sup>2)</sup>	1 + max. one half-wave <sup>2)</sup>
• OFF-delay	ms	1 + max. one half-wave	15 + max. one half-wave	40 + max. one half-wave	1 + max. one half-wave

<sup>1)</sup> Applies to the "Low Power" version 3RF21...-AA...-0KN0.

<sup>2)</sup> Only for zero-point switching devices.



## Solid-State Switching Devices for Resistive/Inductive Loads

### Solid-State Relays

SIRIUS 3RF21 solid-state relays, single-phase, 22.5 mm

#### Selection and ordering data

##### Single-phase solid-state relays (without heat sink) with a width of 22.5 mm

Type current/ performance capacity <sup>1)</sup>	Rated control supply voltage $U_s$	SD	Screw terminals <sup>2)</sup>	⊕	PU (UNIT, SET, M)	PS*	PG
A	V	d					
<b>Zero-point switching, rated operational voltage <math>U_e</math> 24 ... 230 V AC</b>							
	20	24 DC	2	3RF2120-1AA02		1	1 unit 41C
	30		2	3RF2130-1AA02		1	1 unit 41C
	50		2	3RF2150-1AA02		1	1 unit 41C
	70		2	3RF2170-1AA02		1	1 unit 41C
	90		5	3RF2190-1AA02		1	1 unit 41C
	20	110 ... 230 AC	2	3RF2120-1AA22		1	1 unit 41C
	30		2	3RF2130-1AA22		1	1 unit 41C
	50		5	3RF2150-1AA22		1	1 unit 41C
	70		5	3RF2170-1AA22		1	1 unit 41C
	90		5	3RF2190-1AA22		1	1 unit 41C
3RF2120-1AA02	20	4 ... 30 DC	2	3RF2120-1AA42		1	1 unit 41C
	30		2	3RF2130-1AA42		1	1 unit 41C
<b>Zero-point switching, rated operational voltage <math>U_e</math> 48 ... 460 V AC</b>							
20	24 DC	2	3RF2120-1AA04		1	1 unit 41C	
30		2	3RF2130-1AA04		1	1 unit 41C	
50		2	3RF2150-1AA04		1	1 unit 41C	
70		2	3RF2170-1AA04		1	1 unit 41C	
90		2	3RF2190-1AA04		1	1 unit 41C	
20	24 AC/DC	5	3RF2150-1AA14		1	1 unit 41C	
20	110 ... 230 AC	2	3RF2120-1AA24		1	1 unit 41C	
30		2	3RF2130-1AA24		1	1 unit 41C	
50		5	3RF2150-1AA24		1	1 unit 41C	
70		2	3RF2170-1AA24		1	1 unit 41C	
90		5	3RF2190-1AA24		1	1 unit 41C	
<b>Zero-point switching, rated operational voltage <math>U_e</math> 48 ... 600 V AC</b>							
70	24 DC Low Power	5	3RF2170-1AA05-0KNO		1	1 unit 41C	
20	4 ... 30 DC	5	3RF2120-1AA45		1	1 unit 41C	
30		5	3RF2130-1AA45		1	1 unit 41C	
50		5	3RF2150-1AA45		1	1 unit 41C	
70		2	3RF2170-1AA45		1	1 unit 41C	
90		5	3RF2190-1AA45		1	1 unit 41C	
<b>Zero-point switching · Blocking voltage 1 600 V, rated operational voltage <math>U_e</math> 48 ... 600 V AC</b>							
30	24 DC	2	3RF2130-1AA06		1	1 unit 41C	
50		2	3RF2150-1AA06		1	1 unit 41C	
70		5	3RF2170-1AA06		1	1 unit 41C	
90		5	3RF2190-1AA06		1	1 unit 41C	
30	110 ... 230 AC	5	3RF2130-1AA26		1	1 unit 41C	
50		5	3RF2150-1AA26		1	1 unit 41C	
70		5	3RF2170-1AA26		1	1 unit 41C	
90		5	3RF2190-1AA26		1	1 unit 41C	

<sup>1)</sup> The type current provides information about the performance capacity of the solid-state relay. The actual permitted rated operational current  $I_e$  can be smaller depending on the connection method and cooling conditions.

<sup>2)</sup> Please note that this version can only be used for a rated current of up to approx. 50 A and a conductor cross-section of 10 mm<sup>2</sup>.

Other rated control supply voltages on request.

## Solid-State Switching Devices for Resistive/Inductive Loads

### Solid-State Relays

#### SIRIUS 3RF21 solid-state relays, single-phase, 22.5 mm

Type current/ performance capacity <sup>1)</sup>	Rated control supply voltage $U_s$	SD	Screw terminals <sup>2)</sup>	⊕	PU (UNIT, SET, M)	PS*	PG
A	V	d	Article No.	Price per PU			
<b>Instantaneous switching, rated operational voltage <math>U_e</math> 24 ... 230 V AC</b>							
50	110 ... 230 AC	5	<b>3RF2150-1BA22</b>		1	1 unit	41C
<b>Instantaneous switching, rated operational voltage <math>U_e</math> 48 ... 460 V AC</b>							
20	24 DC	5	<b>3RF2120-1BA04</b>		1	1 unit	41C
30		5	<b>3RF2130-1BA04</b>		1	1 unit	41C
50		5	<b>3RF2150-1BA04</b>		1	1 unit	41C
70		5	<b>3RF2170-1BA04</b>		1	1 unit	41C
90		5	<b>3RF2190-1BA04</b>		1	1 unit	41C
<b>Instantaneous switching · Blocking voltage 1 600 V, rated operational voltage <math>U_e</math> 48 ... 600 V AC</b>							
50	24 DC	5	<b>3RF2150-1BA06</b>		1	1 unit	41C
<b>Low Noise<sup>3)</sup> · Zero-point switching, rated operational voltage <math>U_e</math> 48 ... 460 V AC</b>							
70	24 DC	5	<b>3RF2170-1CA04</b>		1	1 unit	41C

<sup>1)</sup> The type current provides information about the performance capacity of the solid-state relay. The actual permitted rated operational current  $I_e$  can be smaller depending on the connection method and cooling conditions.

<sup>2)</sup> Please note that this version can only be used for a rated current of up to approx. 50 A and a conductor cross-section of 10 mm<sup>2</sup>.

<sup>3)</sup> See page 6/64.

Other rated control supply voltages on request.

Type current/ performance capacity <sup>1)</sup>	Rated control supply voltage $U_s$	SD	Spring-type terminals <sup>2)</sup>	∞	PU (UNIT, SET, M)	PS*	PG
A	V	d	Article No.	Price per PU			
<b>Zero-point switching, rated operational voltage <math>U_e</math> 24 ... 230 V AC</b>							
20	24 DC	2	<b>3RF2120-2AA02</b>		1	1 unit	41C
50		5	<b>3RF2150-2AA02</b>		1	1 unit	41C
90		5	<b>3RF2190-2AA02</b>		1	1 unit	41C
20	110 ... 230 AC	5	<b>3RF2120-2AA22</b>		1	1 unit	41C
50		5	<b>3RF2150-2AA22</b>		1	1 unit	41C
90		5	<b>3RF2190-2AA22</b>		1	1 unit	41C
20	4 ... 30 DC	5	<b>3RF2120-2AA42</b>		1	1 unit	41C
<b>Zero-point switching, rated operational voltage <math>U_e</math> 48 ... 460 V AC</b>							
20	24 DC	2	<b>3RF2120-2AA04</b>		1	1 unit	41C
50		5	<b>3RF2150-2AA04</b>		1	1 unit	41C
90		5	<b>3RF2190-2AA04</b>		1	1 unit	41C
50	24 AC/DC	5	<b>3RF2150-2AA14</b>		1	1 unit	41C
20	110 ... 230 AC	5	<b>3RF2120-2AA24</b>		1	1 unit	41C
50		5	<b>3RF2150-2AA24</b>		1	1 unit	41C
90		5	<b>3RF2190-2AA24</b>		1	1 unit	41C
<b>Zero-point switching, rated operational voltage <math>U_e</math> 48 ... 600 V AC</b>							
20	4 ... 30 DC	5	<b>3RF2120-2AA45</b>		1	1 unit	41C
<b>Zero-point switching · Blocking voltage 1 600 V, rated operational voltage <math>U_e</math> 48 ... 600 V AC</b>							
50	24 DC	5	<b>3RF2150-2AA06</b>		1	1 unit	41C
90		5	<b>3RF2190-2AA06</b>		1	1 unit	41C
50	110 ... 230 AC	5	<b>3RF2150-2AA26</b>		1	1 unit	41C
90		5	<b>3RF2190-2AA26</b>		1	1 unit	41C



3RF2120-2AA02

<sup>1)</sup> The type current provides information about the performance capacity of the solid-state relay. The actual permitted rated operational current  $I_e$  can be smaller depending on the connection method and cooling conditions.

<sup>2)</sup> Please note that the version with spring-type terminals can only be used for a rated current of up to approx. 20 A and a conductor cross-section of 2.5 mm<sup>2</sup>. Higher currents can be achieved by connecting two conductors per terminal.

Other rated control supply voltages on request.

## Solid-State Switching Devices for Resistive/Inductive Loads

### Solid-State Relays





#### SIRIUS 3RF21 solid-state relays, single-phase, 22.5 mm

Type current/ performance capacity <sup>1)</sup>	Rated control supply voltage $U_s$	SD	Ring terminal lug connection	PU (UNIT, SET, M)	PS*	PG	
A	V	d	Article No.	Price per PU			
<b>Zero-point switching, rated operational voltage <math>U_e</math> 24 ... 230 V AC</b>							
	20	24 DC	5	<b>3RF2120-3AA02</b>	1	1 unit	41C
	50		5	<b>3RF2150-3AA02</b>	1	1 unit	41C
	90		5	<b>3RF2190-3AA02</b>	1	1 unit	41C
	20	110 ... 230 AC	5	<b>3RF2120-3AA22</b>	1	1 unit	41C
	50		5	<b>3RF2150-3AA22</b>	1	1 unit	41C
	90		5	<b>3RF2190-3AA22</b>	1	1 unit	41C
<b>Zero-point switching, rated operational voltage <math>U_e</math> 48 ... 460 V AC</b>							
	20	24 DC	5	<b>3RF2120-3AA04</b>	1	1 unit	41C
	50		5	<b>3RF2150-3AA04</b>	1	1 unit	41C
	90		5	<b>3RF2190-3AA04</b>	1	1 unit	41C
	20	110 ... 230 AC	5	<b>3RF2120-3AA24</b>	1	1 unit	41C
	50		5	<b>3RF2150-3AA24</b>	1	1 unit	41C
	90		5	<b>3RF2190-3AA24</b>	1	1 unit	41C
	90	4 ... 30 DC	5	<b>3RF2190-3AA44</b>	1	1 unit	41C
<b>Zero-point switching · Blocking voltage 1600 V, rated operational voltage <math>U_e</math> 48 ... 600 V AC</b>							
	50	24 DC	5	<b>3RF2150-3AA06</b>	1	1 unit	41C
	90		5	<b>3RF2190-3AA06</b>	1	1 unit	41C
	50	110 ... 230 AC	5	<b>3RF2150-3AA26</b>	1	1 unit	41C
	90		5	<b>3RF2190-3AA26</b>	1	1 unit	41C

<sup>1)</sup> The type current provides information about the performance capacity of the solid-state relay. The actual permitted rated operational current  $I_e$  can be smaller depending on the connection method and cooling conditions.

Other rated control supply voltages on request.

#### Accessories

Version	SD	Article No.	Price per PU	PU (UNIT, SET, M)	PS*	PG
	d					
<b>Optional accessories</b>						
		<b>Spring-type terminals</b>				
		2	<b>3RA2908-1A</b>	1	1 unit	41B
		<b>Screwdrivers</b> For all SIRIUS devices with spring-type terminals Length approx. 200 mm, size 3.0 mm x 0.5 mm, titanium gray/black, partially insulated				
3RA2908-1A						
		<b>Ring terminal lug connection</b>				
		2	<b>3RF2900-3PA88</b>	1	10 units	41C
		<b>Terminal covers</b> For 3RF21 solid-state relays in ring terminal lug connection (With this terminal cover, degree of protection IP20 can be achieved in the terminal compartment in the case of ring terminal lug connections. It can also be used for screw terminals after simple adaptation)				
3RF2900-3PA88						
<b>Control connectors</b>						
		<b>Screw terminals</b>				
		5	<b>3RF2900-1TA88</b>	1	50 units	41C
		<b>Replacement control connectors</b> For 3RF20/21/22 Screw terminals				
		5	<b>3RF2900-2TA88</b>	1	50 units	41C
		<b>Replacement control connectors</b> For 3RF20/21/22 Spring-type terminals				
		5	<b>3RF2900-2TB88</b>	1	10 units	41C
		<b>Control connectors</b> For 3RF20/21/22 Spring-type terminals with two clamping points per contact				

## Solid-State Switching Devices for Resistive/Inductive Loads

### Solid-State Relays

#### SIRIUS 3RF20 solid-state relays, single-phase, 45 mm

#### Overview

##### Single-phase solid-state relays (without heat sink) with a width of 45 mm

The solid-state relays with a width of 45 mm provide for connection of the power supply lead and the load from above. This makes it easy to replace existing solid-state relays in existing arrangements.

The connection of the control cable is as space-saving as the 22.5 mm design, as it is simply plugged on.

#### Technical specifications

##### More information

System Manual "SIRIUS Modular System – System Overview", see <https://support.industry.siemens.com/cs/ww/en/view/60311318>

FAQs, see <https://support.industry.siemens.com/cs/ww/en/ps/16225/faq>

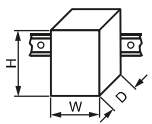
Type		3RF20.-1....	3RF20.-4....
Dimensions (W x H x D)	 mm	45 x 58 x 48	45 x 58 x 48

##### General data

##### Ambient temperature

• During operation, derating from 40 °C	°C	-25 ... +60
• During storage	°C	-55 ... +80

<b>Installation altitude</b>	m	0 ... 1 000; derating from 1 000
------------------------------	---	----------------------------------

<b>Shock resistance</b> acc. to IEC 60068-2-27	g/ms	15 /11
--	------	--------

<b>Vibration resistance</b> acc. to IEC 60068-2-6	g	2
---	---	---



<b>Degree of protection</b>		IP20
-----------------------------	--	------

##### Electromagnetic compatibility (EMC)

• Emitted interference			
- Conducted interference voltage acc. to IEC 60947-4-3			Class A for industrial applications
- Emitted, high-frequency interference voltage acc. to IEC 60947-4-3			Class B for residential, business and commercial applications
• Interference immunity			
- Electrostatic discharge acc. to IEC 61000-4-2 (corresponds to degree of severity 3)	kV		Contact discharge 4; air discharge 8; behavior criterion 2
- Induced RF fields according to IEC 61000-4-6	MHz	0.15 ... 80; 140 dBµV; behavior criterion 1	
- Burst acc. to IEC 61000-4-4	kV	2/5.0 kHz; behavior criterion 2	
- Surge acc. to IEC 61000-4-5	kV	Conductor - ground 2; conductor - conductor 1; behavior criterion 2	

##### Mounting

• Screws (not included in the scope of supply)		2 x M4
• Tightening torques	Nm	1.5

Connection type		 Screw terminals	 Spring-type terminals
<b>Connection, main contacts</b>			
• Conductor cross-sections			
- Solid	mm <sup>2</sup>	2 x (1.5 ... 2.5) <sup>1)</sup> , 2 x (2.5 ... 6) <sup>1)</sup>	--
- Finely stranded with end sleeve	mm <sup>2</sup>	2 x (1 ... 2.5) <sup>1)</sup> , 2 x (2.5 ... 6) <sup>1)</sup> , 1 x 10	--
- Solid or stranded, AWG cables	AWG	2 x (14 ... 10)	--
• Terminal screw		M4	--
• Tightening torque	Nm	2 ... 2.5	--
	lb.in	7 ... 10.3	--
<b>Connection, auxiliary/control contacts</b>			
• Conductor cross-sections	mm <sup>2</sup>	1 x (0.5 ... 2.5), 2 x (0.5 ... 1.0)	0.5 ... 2.5
	AWG	20 ... 12	20 ... 12
• Stripped length	mm	7	10
• Terminal screw		M3	--
• Tightening torque	Nm	0.5 ... 0.6	--
	lb.in	4.5 ... 5.3	--

<sup>1)</sup> If two different conductor cross-sections are connected to one clamping point, both cross-sections must lie in one of the ranges specified.

## Solid-State Switching Devices for Resistive/Inductive Loads

### Solid-State Relays

#### SIRIUS 3RF20 solid-state relays, single-phase, 45 mm

Type	$I_{\max}^{1)}$ at $R_{\text{thha}}/T_u = 40\text{ °C}$		$I_e$ acc. to IEC 60947-4-3 at $R_{\text{thha}}/T_u = 40\text{ °C}$		$I_e$ acc. to UL/CSA at $R_{\text{thha}}/T_u = 50\text{ °C}$		Power loss at $I_{\max}$ W	Minimum load current A	Off-state current mA
	A	K/W	A	K/W	A	K/W			
<b>Main circuit</b>									
3RF2020-1.A..	20	2.0	20	1.7	20	1.3	28.6	0.1	10
3RF2030-1.A..	30	1.1	30	0.79	30	0.56	44.2	0.5	10
3RF2050-1.A..	50	0.68	50	0.48	50	0.33	66	0.5	10
3RF2070-1.A..	70	0.40	50	0.77	50	0.6	94	0.5	10
3RF2090-1.A..	88	0.33	50	0.94	50	0.85	118	0.5	10

<sup>1)</sup> The current  $I_{\max}$  provides information about the performance of the solid-state relay. The actual permitted rated operational current  $I_e$  can be smaller depending on the connection method and cooling conditions.

#### Note:

The required heat sinks for the corresponding load currents can be determined from the characteristic curves (see page 6/63, "More information"). The minimum thickness values for the mounting surface must be observed.

Type	Rated peak withstand current $I_{\text{tsm}}$	$I^2t$ value
	A	A <sup>2</sup> s
<b>Main circuit</b>		
3RF2020-1.A..	200	200
3RF2030-1.A.2	300	450
3RF2030-1.A.4	300	450
3RF2030-1.A.6	400	800
3RF2050-1.A..	600	1 800
3RF2070-1.A.2	1 200	7 200
3RF2070-1.A.4	1 200	7 200
3RF2070-1.A.5	1 200	7 200
3RF2070-1.A.6	1 150	6 600
3RF2090-1.A..	1 150	6 600

Type		3RF20.0-1.A.2	3RF20.0-1.A.4	3RF20.0-1.A.5	3RF20.0-1.A.6
<b>Main circuit</b>					
Rated operational voltage $U_e$	V AC	24 ... 230	48 ... 460	48 ... 600	
• Operating range	V AC	20 ... 253	40 ... 506	40 ... 660	
• Rated frequency	Hz	50/60 ± 10%			
Rated insulation voltage $U_i$	V	600			
Blocking voltage	V	800	1 200		1 600
Rate of voltage rise	V/μs	1 000			

Type		3RF20.0-1.A.0.	3RF20.0-1.A.2.	3RF20.0-1.A.4.
<b>Control circuit</b>				
Method of operation		DC operation	AC operation	DC operation
Rated control supply voltage $U_s$	V	24	110 ... 230	4 ... 30
Rated frequency of the control supply voltage	Hz	--	50/60 ± 10%	--
Control supply voltage, max.	V	30	253	30
Typical actuating current	mA	20	15	20
Response voltage	V	15	90	4
Drop-out voltage	V	5	40	1
<b>Operating times</b>				
• ON-delay	ms	1 + max. one half-wave <sup>1)</sup>	40 + max. one half-wave <sup>1)</sup>	1 + max. one half-wave <sup>1)</sup>
• OFF-delay	ms	1 + max. one half-wave	40 + max. one half-wave	1 + max. one half-wave

<sup>1)</sup> Only for zero-point switching devices.

## Solid-State Switching Devices for Resistive/Inductive Loads

### Solid-State Relays

#### SIRIUS 3RF20 solid-state relays, single-phase, 45 mm

#### Selection and ordering data

##### Single-phase solid-state relays (without heat sink) with a width of 45 mm

Type current/ performance capacity <sup>1)</sup>	Rated control supply voltage $U_s$	SD	Screw terminals <sup>2)</sup>	⊕	PU (UNIT, SET, M)	PS*	PG
A	V	d	Article No.	Price per PU			
<b>Zero-point switching, rated operational voltage <math>U_e</math> 24 ... 230 V AC</b>							
	20	24 DC	2	3RF2020-1AA02		1	1 unit 41C
	30		2	3RF2030-1AA02		1	1 unit 41C
	50		2	3RF2050-1AA02		1	1 unit 41C
	70		2	3RF2070-1AA02		1	1 unit 41C
	90		2	3RF2090-1AA02		1	1 unit 41C
	20	110 ... 230 AC	2	3RF2020-1AA22		1	1 unit 41C
	30		2	3RF2030-1AA22		1	1 unit 41C
	50		5	3RF2050-1AA22		1	1 unit 41C
	70		5	3RF2070-1AA22		1	1 unit 41C
	90		5	3RF2090-1AA22		1	1 unit 41C
3RF2020-1AA02	20	4 ... 30 DC	5	3RF2020-1AA42		1	1 unit 41C
	30		5	3RF2030-1AA42		1	1 unit 41C
<b>Zero-point switching, rated operational voltage <math>U_e</math> 48 ... 460 V AC</b>							
20	24 DC	2	3RF2020-1AA04		1	1 unit 41C	
30		2	3RF2030-1AA04		1	1 unit 41C	
50		2	3RF2050-1AA04		1	1 unit 41C	
70		2	3RF2070-1AA04		1	1 unit 41C	
90		2	3RF2090-1AA04		1	1 unit 41C	
20	110 ... 230 AC	5	3RF2020-1AA24		1	1 unit 41C	
30		5	3RF2030-1AA24		1	1 unit 41C	
50		5	3RF2050-1AA24		1	1 unit 41C	
70		5	3RF2070-1AA24		1	1 unit 41C	
90		5	3RF2090-1AA24		1	1 unit 41C	
50	4 ... 30 DC	2	3RF2050-1AA44		1	1 unit 41C	
<b>Zero-point switching, rated operational voltage <math>U_e</math> 48 ... 600 V AC</b>							
20	4 ... 30 DC	5	3RF2020-1AA45		1	1 unit 41C	
50		5	3RF2050-1AA45		1	1 unit 41C	
70		2	3RF2070-1AA45		1	1 unit 41C	
90		5	3RF2090-1AA45		1	1 unit 41C	
<b>Zero-point switching · Blocking voltage 1 600 V, rated operational voltage <math>U_e</math> 48 ... 600 V AC</b>							
30	24 DC	5	3RF2030-1AA06		1	1 unit 41C	
50		5	3RF2050-1AA06		1	1 unit 41C	
70		5	3RF2070-1AA06		1	1 unit 41C	
90		5	3RF2090-1AA06		1	1 unit 41C	
30	110 ... 230 AC	5	3RF2030-1AA26		1	1 unit 41C	
50		5	3RF2050-1AA26		1	1 unit 41C	
70		5	3RF2070-1AA26		1	1 unit 41C	
90		5	3RF2090-1AA26		1	1 unit 41C	
<b>Instantaneous switching, rated operational voltage <math>U_e</math> 48 ... 460 V AC</b>							
30	24 DC	5	3RF2030-1BA04		1	1 unit 41C	

<sup>1)</sup> The type current provides information about the performance capacity of the solid-state relay. The actual permitted rated operational current  $I_e$  can be smaller depending on the connection method and cooling conditions.

<sup>2)</sup> Please note that this version can only be used for a rated current of up to approx. 50 A and a conductor cross-section of 10 mm<sup>2</sup>.

## Solid-State Switching Devices for Resistive/Inductive Loads Solid-State Relays

### SIRIUS 3RF20 solid-state relays, single-phase, 45 mm

Type current/ performance capacity <sup>1)</sup>	Rated control supply voltage $U_s$	SD	<b>Screw terminals + spring-type terminals</b> (control current side)		PU (UNIT, SET, M)	PS*	PG
A	V	d	Article No.	Price per PU			
<b>Zero-point switching, rated operational voltage <math>U_e</math> 24 ... 230 V AC</b>							
50	24 DC	5	<b>3RF2050-4AA02</b>		1	1 unit	41C



3RF2050-4AA02

<sup>1)</sup> The type current provides information about the performance capacity of the solid-state relay. The actual permitted rated operational current  $I_e$  can be smaller depending on the connection method and cooling conditions.

Accessories, [see page 6/69](#).

## Solid-State Switching Devices for Resistive/Inductive Loads

### Solid-State Relays

#### SIRIUS 3RF22 solid-state relays, three-phase, 45 mm

#### Overview





##### Three-phase solid-state relays (without heat sink) with a width of 45 mm

With its compact design and a width of just 45 mm, which stays the same even at currents of up to 55 A, the 3RF22 solid-state relay offers an ultra small footprint. The logical connection method, with the power infeed from above and load connection from below, ensures tidy installation in the control cabinet.

Important features:

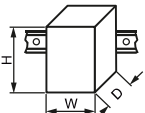
- LED display
- Variety of connection methods
- Plug-in control connection
- Degree of protection IP20 (with ring terminal lug connection IP00)
- Zero-point switching, two- or three-phase controlled

#### Technical specifications

More information				
System Manual "SIRIUS Modular System – System Overview", see <a href="https://support.industry.siemens.com/cs/ww/en/view/60311318">https://support.industry.siemens.com/cs/ww/en/view/60311318</a>		FAQs, see <a href="https://support.industry.siemens.com/cs/ww/en/ps/16226/faq">https://support.industry.siemens.com/cs/ww/en/ps/16226/faq</a>		
Type		<b>3RF22..-1....</b>	<b>3RF22..-2....</b>	<b>3RF22..-3....</b>
Dimensions (W x H x D)		45 x 95 x 47	45 x 95 x 47	45 x 95 x 47
General data				
<b>Ambient temperature</b>				
• During operation, derating from 40 °C	°C	-25 ... +60		
• During storage	°C	-55 ... +80		
<b>Installation altitude</b>	m	0 ... 1 000; > 1 000 ask Technical Assistance		
<b>Shock resistance</b> acc. to IEC 60068-2-27	g/ms	15/11		
<b>Vibration resistance</b> acc. to IEC 60068-2-6	g	2		
<b>Degree of protection</b>		IP20		IP00
<b>Insulation strength</b> at 50/60 Hz (main/control circuit to floor)	V rms	4 000		
<b>Electromagnetic compatibility (EMC)</b>				
• Emitted interference		Class A for industrial applications <sup>1)</sup>		
- Conducted interference voltage acc. to IEC 60947-4-3				
• Interference immunity				
- Electrostatic discharge acc. to IEC 61000-4-2 (corresponds to degree of severity 3)		kV	Contact discharge 4; air discharge 8; behavior criterion 2	
- Induced RF fields according to IEC 61000-4-6		MHz	0.15 ... 80; 140 dBµV; behavior criterion 1	
- Burst acc. to IEC 61000-4-4		kV	2/5.0 kHz; behavior criterion 2	
- Surge acc. to IEC 61000-4-5		kV	Conductor - ground 2; conductor - conductor 1; behavior criterion 2	
<b>Mounting</b>				
• Screws (not included in the scope of supply)		Nm	2 x M4	
• Tightening torques		Nm	1.5	
Connection type		 Screw terminals	 Spring-type terminals	 Ring terminal lug connection
Connection, main contacts				
• Conductor cross-sections				
- Solid		mm <sup>2</sup>	2 x (1.5 ... 2.5) <sup>2)</sup> , 2 x (2.5 ... 6) <sup>2)</sup>	
- Finely stranded with end sleeve		mm <sup>2</sup>	2 x (1 ... 2.5) <sup>2)</sup> , 2 x (2.5 ... 6) <sup>2)</sup> , 1 x 10	
- Finely stranded without end sleeve		mm <sup>2</sup>	2 x (0.5 ... 2.5)	
- Solid or stranded, AWG cables		AWG	2 x (18 ... 14)	
• Stripped length		mm	10	
• Terminal screws			M4	
- Tightening torque, Ø 5 ... 6 mm, PZ 2		Nm	2 ... 2.5	
		lb.in	18 ... 22	
• Cable lugs			M5	
- According to DIN 46234			2.5 ... 2	
- According to JIS C 2805			18 ... 22	
- Width, maximum		mm	5-2.5 ... 5-25 R 2-5 ... R 14-5 12	
Connection, auxiliary/control contacts				
• Conductor cross-sections, with or without end sleeve		mm	1 x (0.5 ... 2.5), 2 x (0.5 ... 1.0)	
• Stripped length		AWG	20 ... 12	
• Terminal screw		mm	7	
- Tightening torque, Ø 3.5, PZ 1		Nm	0.5 ... 0.6	
		lb.in	4.5 ... 5.3	

<sup>1)</sup> These products were built as Class A devices. The use of these devices in residential areas could result in lead in radio interference. In this case these may be required to introduce additional interference suppression measures.

<sup>2)</sup> If two different conductor cross-sections are connected to one clamping point, both cross-sections must lie in one of the ranges specified.



## Solid-State Switching Devices for Resistive/Inductive Loads

### Solid-State Relays

#### SIRIUS 3RF22 solid-state relays, three-phase, 45 mm

Type	$I_{\max}^{1)}$ at $R_{\text{thha}}/T_U = 40\text{ °C}$		$I_e$ acc. to IEC 60947-4-3 at $R_{\text{thha}}/T_U = 40\text{ °C}$		$I_e$ acc. to UL/CSA at $R_{\text{thha}}/T_U = 50\text{ °C}$		Power loss at $I_{\max}$ W	Minimum load current A	Max. off-state current mA
	A	K/W	A	K/W	A	K/W			
<b>Main circuit</b>									
3RF2230-1AB..	30	0.57	30	0.57	30	0.44	81	0.5	10
3RF2230-2AB..			20	1.36	20	1.15			
3RF2230-3AB..			30	0.57	30	0.44			
3RF2255-1AB..	55	0.18	50	0.27	50	0.19	151	0.5	10
3RF2255-2AB..			20	1.83	20	1.58			
3RF2255-3AB..			50	0.27	50	0.19			
3RF2230-1AC..	30	0.33	30	0.33	30	0.25	122	0.5	10
3RF2230-2AC..			20	0.86	20	0.72			
3RF2230-3AC..			30	0.33	30	0.25			
3RF2255-1AC..	55	0.09	50	0.15	50	0.1	226	0.5	10
3RF2255-2AC..			20	1.19	20	1.02			
3RF2255-3AC..			50	0.15	50	0.1			

<sup>1)</sup> The current  $I_{\max}$  provides information about the performance of the solid-state relay. The actual permitted rated operational current  $I_e$  can be smaller depending on the connection method and cooling conditions.

#### Note:

The required heat sinks for the corresponding load currents can be determined from the characteristic curves (see page 6/63, "More information"). The minimum thickness values for the mounting surface must be observed.

Type	Rated peak withstand current $I_{\text{ISM}}$		$i^2t$ value A <sup>2</sup> s
	A		
<b>Main circuit</b>			
3RF2230-....5	300		450
3RF2255-....5	600		1800

Type	3RF22...-AB.5		3RF22...-AC.5	
<b>Main circuit</b>				
Controlled phases	2-phase		3-phase	
Rated operational voltage $U_e$	V AC	48 ... 600		
• Operating range	V AC	40 ... 660		
• Rated frequency	Hz	50/60 ± 10%		
Rated insulation voltage $U_i$	V	600		
Rated impulse withstand voltage $U_{\text{imp}}$	kV	6		
Blocking voltage	V	1200		
Rate of voltage rise	V/μs	1000		

Type	3RF22...-A.3.		3RF22...-A.4.	
<b>Control circuit</b>				
Method of operation	AC operation		DC operation	
Rated control supply voltage $U_s$	V	110	4 ... 30	
Rated frequency of the control supply voltage	Hz	50/60 ± 10%	--	
Control supply voltage, max.	V	121	30	
Typical actuating current	mA	15	30	
Response voltage	V	90	4	
Drop-out voltage	V	< 40	1	
<b>Operating times</b>				
• ON-delay	ms	40 + max. one half-wave	1 + max. one half-wave	
• OFF-delay	ms	40 + max. one half-wave	1 + max. one half-wave	

## Solid-State Switching Devices for Resistive/Inductive Loads

### Solid-State Relays

#### SIRIUS 3RF22 solid-state relays, three-phase, 45 mm

##### Selection and ordering data

Type current/ performance capacity <sup>1)</sup>	Rated control supply voltage $U_s$	SD	Screw terminals <sup>2)</sup>	⊕	PU (UNIT, SET, M)	PS*	PG
A	V	d	Article No.		Price per PU		

##### Zero-point switching, rated operational voltage $U_e$ 48 ... 600 V AC



3RF2230-1AB45

##### Two-phase controlled

30	110 AC	5	3RF2230-1AB35		1	1 unit	41C
55		5	3RF2255-1AB35		1	1 unit	41C
30	4 ... 30 DC	5	3RF2230-1AB45		1	1 unit	41C
55		5	3RF2255-1AB45		1	1 unit	41C

##### Three-phase controlled

30	110 AC	5	3RF2230-1AC35		1	1 unit	41C
55		5	3RF2255-1AC35		1	1 unit	41C
30	4 ... 30 DC	2	3RF2230-1AC45		1	1 unit	41C
55		5	3RF2255-1AC45		1	1 unit	41C

<sup>1)</sup> The type current provides information about the performance capacity of the solid-state relay. The actual permitted rated operational current  $I_e$  can be smaller depending on the connection method and cooling conditions.

<sup>2)</sup> Please note that the version with an M4 screw connection can only be used for a rated current of up to approx. 50 A and a conductor cross-section of 10 mm<sup>2</sup>.

Type current/ performance capacity <sup>1)</sup>	Rated control supply voltage $U_s$	SD	Spring-type terminals <sup>3)</sup>	⊕	PU (UNIT, SET, M)	PS*	PG
A	V	d	Article No.		Price per PU		

##### Zero-point switching, rated operational voltage $U_e$ 48 ... 600 V AC



3RF2230-2AB45

##### Two-phase controlled

30	4 ... 30 DC	5	3RF2230-2AB45		1	1 unit	41C
55		5	3RF2255-2AB45		1	1 unit	41C

##### Three-phase controlled

30	4 ... 30 DC	5	3RF2230-2AC45		1	1 unit	41C
55		5	3RF2255-2AC45		1	1 unit	41C

<sup>1)</sup> The type current provides information about the performance capacity of the solid-state relay. The actual permitted rated operational current  $I_e$  can be smaller depending on the connection method and cooling conditions.

<sup>2)</sup> Please note that the version with spring-type terminals can only be used for a rated current of up to approx. 20 A and a conductor cross-section of 2.5 mm<sup>2</sup>. Higher currents can be achieved by connecting two conductors per terminal.

Type current/ performance capacity <sup>1)</sup>	Rated control supply voltage $U_s$	SD	Ring terminal lug connection	⊕	PU (UNIT, SET, M)	PS*	PG
A	V	d	Article No.		Price per PU		

##### Zero-point switching, rated operational voltage $U_e$ 48 ... 600 V AC



3RF2230-3AB45

##### Two-phase controlled

30	4 ... 30 DC	5	3RF2230-3AB45		1	1 unit	41C
55		5	3RF2255-3AB45		1	1 unit	41C

##### Three-phase controlled

30	4 ... 30 DC	5	3RF2230-3AC45		1	1 unit	41C
55		5	3RF2255-3AC45		1	1 unit	41C

<sup>1)</sup> The type current provides information about the performance capacity of the solid-state relay. The actual permitted rated operational current  $I_e$  can be smaller depending on the connection method and cooling conditions.

For accessories, see page 6/69.

## Solid-State Switching Devices for Resistive/Inductive Loads

### Solid-State Contactors

General data

#### Overview

##### Solid-state contactors (with integrated heat sink)

The complete units consist of a solid-state relay plus optimized heat sink, and are therefore ready to use. They offer defined rated currents to make selection as easy as possible. Depending on the version, current strengths of up to 70 A are achieved. Like all of our solid-state switching devices, one of their particular advantages is their compact and space-saving design.

With their insulated mounting foot they can easily be snapped onto a standard mounting rail, or they can be mounted on support plates with fixing screws. This insulation enables them to be used in circuits with protective extra-low voltage (PELV) or safety extra-low voltage (SELV) in building management systems. For other applications, such as for extended personal safety, the heat sink can be grounded through a screw terminal.

The solid-state contactors are available in 2 different versions:

- 3RF23 single-phase solid-state contactors
- 3RF24 three-phase solid-state contactors

##### Single-phase versions

The 3RF23 solid-state contactors can be expanded with various function modules to adapt them to individual applications.

##### Version for resistive loads "zero-point switching"

This standard version is often used for switching space heaters on and off.

##### Version for inductive loads "instantaneous switching"

In this version the solid-state contactor is specifically matched to inductive loads. Whether it is a matter of frequent actuation of the valves in a filling plant or starting and stopping small operating mechanisms in packet distribution systems, operation is carried out safely and noiselessly.

##### Special "low noise" version

Thanks to a special control circuit, this special version can be used in public networks up to 16 A without any additional measures such as interference suppressor filters. As a result, in terms of emitted interference, it conforms to limit value curve class B according to IEC 60947-4-3.

##### Special "Short-circuit proof" version

Skillful matching of the power semiconductor with the performance capacity of the solid-state contactor means that "short-circuit strength" can be achieved with a standard miniature circuit breaker. In combination with a B-type MCB or a conventional line protection fuse, the result is a short-circuit proof feeder.

In order to achieve problem-free short-circuit protection by means of miniature circuit breakers, however, certain boundary conditions must be observed. As the magnitude and duration of the short-circuit current are determined not only by the short-circuit breaking response of the miniature circuit breaker but also the properties of the wiring system, such as the internal resistance of the input to the network and damping by controls and cables, particular attention must also be paid to these parameters. The necessary cable lengths are therefore shown for the main factor, the line resistance, in the table below.

The following miniature circuit breakers with a B characteristic and 10 kA or 6 kA breaking capacity protect the 3RF23...-DA.. solid-state contactors in the event of short-circuits on the load and the specified conductor cross-sections and lengths:

Rated current of the miniature circuit breaker	Example of type <sup>1)</sup>	Max. conductor cross-section	Minimum cable length from contactor to load
6 A	5SY4106-6	1 mm <sup>2</sup>	5 m
10 A	5SY4110-6	1.5 mm <sup>2</sup>	8 m
16 A	5SY4116-6	1.5 mm <sup>2</sup>	12 m
		2.5 mm <sup>2</sup>	20 m
20 A	5SY4120-6	2.5 mm <sup>2</sup>	20 m
25 A	5SY4125-6	2.5 mm <sup>2</sup>	26 m

<sup>1)</sup> The miniature circuit breakers can be used up to a maximum rated voltage of 480 V!

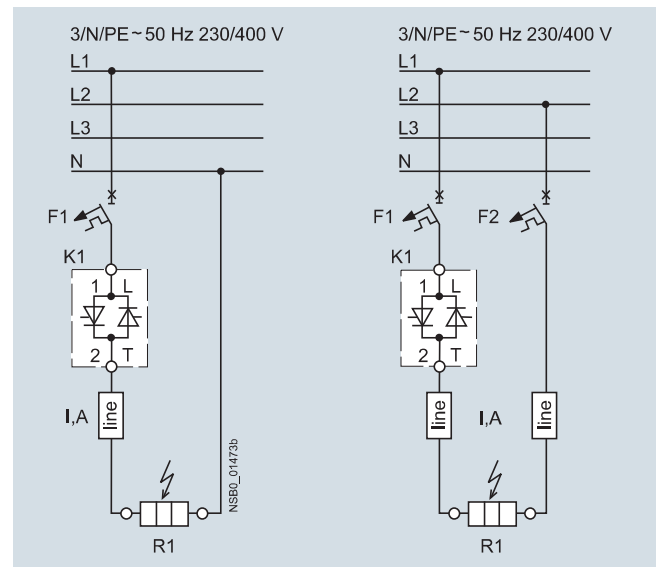

Solid-state contactor protection

The setup and installation above can also be used for the solid-state relays with an  $I^2t$  value of at least 6600 A<sup>2</sup>s.

##### 3-phase versions

The 3-phase solid-state contactors for resistive loads up to 50 A are available with

- Two-phase control (suitable in particular for circuits without connection to the neutral conductor) and
- Three-phase control (suitable for star circuits with connection to the neutral conductor or for applications in which the system requires all phases to be switched)

The converter function module can be snapped onto both versions for the simple power control of AC loads by means of analog signals.

- Check the correct contactor size with the aid of the rated current diagram, taking account of the installation conditions

## Solid-State Switching Devices for Resistive/Inductive Loads

### Solid-State Contactors

#### SIRIUS 3RF23 solid-state contactors, single-phase

#### Overview

Single-phase solid-state contactors with heat sink

Their compact design with optimized heat sink enables small complete units with currents up to 70 A. They also offer all the

special features of the solid-state relay in terms of time and space savings.



#### Technical specifications

##### More information

System Manual "SIRIUS Modular System – System Overview", see <https://support.industry.siemens.com/cs/ww/en/view/60311318>

FAQs, see <https://support.industry.siemens.com/cs/ww/en/ps/16228/faq>

Type	3RF23...-A...	3RF23...-B...	3RF23...-C...	3RF23...-D...
Dimensions (W x H x D)	See page 6/79			
<b>General data</b>				
<b>Ambient temperature</b>				
• During operation, derating from 40 °C	°C	-25 ... +60		
• During storage	°C	-55 ... +80		
<b>Installation altitude</b>	m	0 ... 1 000; derating from 1 000		
<b>Shock resistance</b> acc. to IEC 60068-2-27	g/ms	15/11		
<b>Vibration resistance</b> acc. to IEC 60068-2-6	g	2		
<b>Degree of protection</b>	IP20 (for ring terminal lug connection when using the terminal cover 3RA2900-3PA88, otherwise IP00)			
<b>Electromagnetic compatibility (EMC)</b>				
• Emitted interference according to IEC 60947-4-3		Class A for industrial applications		
- Conducted interference voltage		Class A for industrial applications; Class B for residential, business and commercial applications up to 16 A, AC-51 Low Noise		Class A for industrial applications
- Emitted, high-frequency interference voltage		Class B for residential, business and commercial applications		
• Interference immunity		Contact discharge 4; air discharge 8; behavior criterion 2		
- Electrostatic discharge acc. to IEC 61000-4-2 (corresponds to degree of severity 3)	kV			
- Induced RF fields according to IEC 61000-4-6	MHz	0.15 ... 80; 140 dBµV; behavior criterion 1		
- Burst acc. to IEC 61000-4-4	kV	2/5.0 kHz; behavior criterion 2		
- Surge acc. to IEC 61000-4-5	kV	Conductor - ground 2; conductor - conductor 1; behavior criterion 2		



Type	3RF23...-1....	3RF23...-2....	3RF23...-3....	
<b>General data</b>				
<b>Connection type</b>	 <b>Screw terminals</b>	 <b>Spring-type terminals</b>	 <b>Ring terminal lug connection</b>	
<b>Connection, main contacts</b>				
• Conductor cross-section				
- Solid	mm <sup>2</sup>	2 x (1.5 ... 2.5) <sup>1)</sup> , 2 x (2.5 ... 6) <sup>1)</sup>	2 x (0.5 ... 2.5)	
- Finely stranded with end sleeve	mm <sup>2</sup>	2 x (1 ... 2.5) <sup>1)</sup> , 2 x (2.5 ... 6) <sup>1)</sup> , 1 x 10	2 x (0.5 ... 1.5)	
- Finely stranded without end sleeve	mm <sup>2</sup>	--	2 x (0.5 ... 2.5)	
- Solid or stranded, AWG cables	AWG	2 x (14 ... 10)	2 x (18 ... 14)	
• Terminal screws		M4	M5	
• Tightening torque	Nm lb.in	2 ... 2.5 7 ... 10.3	--	2 ... 2.5 7 ... 10.3
• Cable lugs		--	--	5-2.5, 5-6, 5-10, 5-16, 5-25
- According to DIN 46234		--	--	R 2-5, R 5.5-5, R 8-5, R 14-5
- According to JIS C 2805		--	--	12
- Width, maximum	mm	--	--	--
<b>Connection, auxiliary/control contacts</b>				
• Conductor cross-section	mm AWG	1 x (0.5 ... 2.5) <sup>1)</sup> , 2 x (0.5 ... 1.0)	0.5 ... 2.5 20 ... 12	1 x (0.5 ... 2.5), 2 x (0.5 ... 1.0) 20 ... 12
• Stripped length	mm	7	10	7
• Terminal screw		M3	--	M3
• Tightening torque	Nm lb.in	0.5 ... 0.6 4.5 ... 5.3	--	0.5 ... 0.6 4.5 ... 5.3

<sup>1)</sup> If two different conductor cross-sections are connected to one clamping point, both cross-sections must lie in one of the ranges specified.

## Solid-State Switching Devices for Resistive/Inductive Loads

### Solid-State Contactors

#### SIRIUS 3RF23 solid-state contactors, single-phase

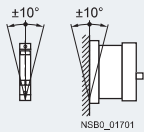
Type	3RF23..-1....	3RF23..-2....	3RF23..-3....
<b>General data</b>			
<b>Connection type</b>	 Screw terminals	 Spring-type terminals	 Ring terminal lug connection
<b>Grounding screw</b> (not included in the scope of supply)	M5		
• Size (standard screw)	M5		
<b>Permissible mounting position</b>			

Type	3RF23..-....2	3RF23..-....4	3RF23..-....5	3RF23..-....6
<b>Main circuit</b>				
<b>Rated operational voltage <math>U_e</math></b>	V AC 24 ... 230	48 ... 460	48 ... 600	
• Operating range	V AC 20 ... 253	40 ... 506	40 ... 660	
• Rated frequency	Hz 50/60 ± 10%			
<b>Rated insulation voltage <math>U_i</math></b>	V 600			
<b>Blocking voltage</b>	V 800	1 200		1 600
<b>Rate of voltage rise</b>	V/ $\mu$ s 1 000			

Type	3RF23..-...0.	3RF23..-...1.	3RF23..-...2.	3RF23..-...4.
<b>Control circuit</b>				
<b>Method of operation</b>	DC operation	AC/DC operation	AC operation	DC operation
<b>Rated control supply voltage <math>U_s</math></b>	V 24 DC	24 AC 24 DC	110 ... 230 AC	4 ... 30 DC
<b>Rated frequency of the control supply voltage</b>	Hz --	50/60 ± 10%	50/60 ± 10%	--
<b>Actuating voltage, max.</b>	V 30	26.5 AC 30 DC	253	30
<b>Typical actuating current</b>	mA 20 / Low Power: <math>10^{1}</math>	20	15	20
<b>Response voltage</b>	V 15	14 AC 15 DC	90	4
<b>Drop-out voltage</b>	V 5	5 AC 5 DC	40	1
<b>Operating times</b>				
• ON-delay	ms 1 + max. one half-wave <sup>2)</sup>	10 + max. one half-wave <sup>2)</sup>	40 + max. one half-wave <sup>2)</sup>	1 + max. one half-wave <sup>2)</sup>
• OFF-delay	ms 1 + max. one half-wave	15 + max. one half-wave	40 + max. one half-wave	1 + max. one half-wave

<sup>1)</sup> Applies to the "Low Power" version 3RF23..-AA..-0KN0.

<sup>2)</sup> Only for zero-point switching devices.

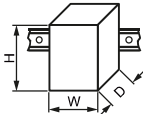
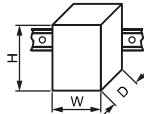
Type	Type current/ performance capacity <sup>1)</sup> $I_{AC-51}$	Dimensions (W x H x D) incl. heat sink	
		Product version up to E05	from E06 <sup>2)</sup>
	A		
		mm	mm
<b>Main circuit</b>			
3RF2310-AA..	10.5	22.5 x 100 x 89	22.5 x 100 x 86
3RF2320-AA.. 3RF2320-CA.. 3RF2320-DA..	20	22.5 x 100 x 135.5	22.5 x 100 x 118.5
3RF2330-AA.. 3RF2330-CA.. 3RF2330-DA..	30	45 x 100 x 151	45 x 100 x 133.5
3RF2340-AA..	40	22.5 x 100 x 135.5	22.5 x 100 x 118.5
3RF2350-AA..	50	67.5 x 100 x 151	67.5 x 100 x 135.5
3RF2370-AA..	70	135 x 100 x 153.5	80 x 100 x 149.5

<sup>1)</sup> The type current provides information about the performance of the solid-state contactor. The actual permitted rated operational current  $I_e$  can be smaller depending on the connection method and installation conditions.

<sup>2)</sup> Conversion of the products to product version E06 will take place from January 1, 2018; for version 3RF2370 from April 1, 2018.

## Solid-State Switching Devices for Resistive/Inductive Loads

### Solid-State Contactors

#### SIRIUS 3RF23 solid-state contactors, single-phase

Type	Type current AC-51/performance capacity <sup>1)</sup>			Power loss at $I_{max}$	Minimum load current	Off-state current	Rated peak withstand current $I_{tsm}$	$I^2t$ value
	at $I_{max}$ at 40 °C	Acc. to IEC 60947-4-3 at 40 °C	Acc. to UL/CSA at 50 °C					
	A	A	A	W	A	mA	A	A <sup>2</sup> s
<b>Main circuit</b>								
3RF2310-AA.2 3RF2310-AA.4 3RF2310-AA.5 3RF2310-AA.6	10.5	7.5	9.6	11	0.1	10	200	200
							400	800
3RF2320-AA.2 3RF2320-AA.4 3RF2320-AA.5 3RF2320-AA.6 3RF2320-CA.2 3RF2320-CA.4 3RF2320-DA.2 3RF2320-DA.4	20	13.2	17.6	20	0.5	10	600	1 800
						25	600	1 800
						10	1 150	6 600
3RF2330-AA.2 3RF2330-AA.4 3RF2330-AA.5 3RF2330-AA.6 3RF2330-CA.2 3RF2330-DA.4	30	22	27	33	0.5	10	600	1 800
						25	600	1 800
		18.5	26	33	0.5	10	1 150	6 600
3RF2340-AA.2 3RF2340-AA.4 3RF2340-AA.5 3RF2340-AA.6	40	33	36	44	0.5	10	1 200	7 200
							1 150	6 600
3RF2350-AA.2 3RF2350-AA.4 3RF2350-AA.5 3RF2350-AA.6	50	36	45	54	0.5	10	1 150	6 600
3RF2370-AA.2 3RF2370-AA.4 3RF2370-AA.5 3RF2370-AA.6	70	70	62	83	0.5	10	1 150	6 600

<sup>1)</sup> The type current provides information about the performance of the solid-state contactor. The actual permitted rated operational current  $I_e$  can be smaller depending on the connection method and installation conditions.

Type	Type current AC-51/performance capacity <sup>1)</sup>			Type current AC-15/performance capacity <sup>1)</sup>		Power loss at $I_{max}$	Minimum load current	Off-state current	Rated peak withstand current $I_{tsm}$	$I^2t$ value
	at $I_{max}$ at 40 °C	according to IEC 60947-4-3 at 40 °C	Acc. to UL/CSA at 50 °C	10 x $I_e$ for 60 ms	Parameters					
	A	A	A	A		W	A	mA	A	A <sup>2</sup> s
<b>Main circuit</b>										
3RF2310-BA.2 3RF2310-BA.4 3RF2310-BA.6	10.5	7.5	9.6	6	1 200 1/h 50% ON period	11	0.1	10	200	200
									400	800
3RF2320-BA.2 3RF2320-BA.4 3RF2320-BA.6	20	13.2	17.6	12	1 200 1/h 50% ON period	20	0.5	10	600	1 800
3RF2330-BA.2 3RF2330-BA.4 3RF2330-BA.6	30	22	27	15	1 200 1/h 50% ON period	33	0.5	10	600	1 800
3RF2340-BA.2 3RF2340-BA.4 3RF2340-BA.6	40	33	36	20	1 200 1/h 50% ON period	44	0.5	10	1 200	7 200
									1 150	6 600
3RF2350-BA.2 3RF2350-BA.4 3RF2350-BA.6	50	36	45	25	1 200 1/h 50% ON period	54	0.5	10	1 150	6 600
3RF2370-BA.2 3RF2370-BA.4 3RF2370-BA.6	70	70	62	27.5	1 200 1/h 50% ON period	83	0.5	10	1 150	6 600

<sup>1)</sup> The type current provides information about the performance of the solid-state contactor. The actual permitted rated operational current  $I_e$  can be smaller depending on the connection method and installation conditions.

## Solid-State Switching Devices for Resistive/Inductive Loads

### Solid-State Contactors

#### SIRIUS 3RF23 solid-state contactors, single-phase



#### Selection and ordering data

##### Selection notes

The solid-state contactors are selected on the basis of details of the network, the load and the ambient conditions. As the solid-state contactors are already equipped with an optimally matched heat sink, the selection process is considerably simpler than that for solid-state relays.

The following procedure is recommended:

- Determine the rated current of the load and the mains voltage
- Select a solid-state contactor with the same or higher rated current than the load

	Type current/ performance capacity <sup>1)</sup> $I_{max}$	Rated control supply voltage $U_s$	SD	Screw terminals	PU (UNIT, SET, M)	PS*	PG	
	A	V	d	Article No.				Price per PU
<b>Zero-point switching · Integrated heat sink, rated operational voltage <math>U_e</math> 24 ... 230 V AC</b>								
	10.5	24 DC	2	3RF2310-1AA02	1	1 unit	41C	
	20		2	3RF2320-1AA02	1	1 unit	41C	
	30		2	3RF2330-1AA02	1	1 unit	41C	
	40		2	3RF2340-1AA02	1	1 unit	41C	
	50		2	3RF2350-1AA02	1	1 unit	41C	
	20	24 DC Low Power	2	3RF2320-1AA02-0KN0	1	1 unit	41C	
	10.5	24 AC/DC	2	3RF2310-1AA12	1	1 unit	41C	
	10.5	110 ... 230 AC	2	3RF2310-1AA22	1	1 unit	41C	
	20		2	3RF2320-1AA22	1	1 unit	41C	
	30		2	3RF2330-1AA22	1	1 unit	41C	
	40		5	3RF2340-1AA22	1	1 unit	41C	
	50		2	3RF2350-1AA22	1	1 unit	41C	
	<b>Zero-point switching · Integrated heat sink, rated operational voltage <math>U_e</math> 48 ... 460 V AC</b>							
		10.5	24 DC	2	3RF2310-1AA04	1	1 unit	41C
20		2		3RF2320-1AA04	1	1 unit	41C	
30		2		3RF2330-1AA04	1	1 unit	41C	
40		2		3RF2340-1AA04	1	1 unit	41C	
50		2		3RF2350-1AA04	1	1 unit	41C	
10.5		24 DC Low Power	2	3RF2310-1AA04-0KN0	1	1 unit	41C	
10.5		24 AC/DC	2	3RF2310-1AA14	1	1 unit	41C	
20			5	3RF2320-1AA14	1	1 unit	41C	
30			2	3RF2330-1AA14	1	1 unit	41C	
40			5	3RF2340-1AA14	1	1 unit	41C	
50			5	3RF2350-1AA14	1	1 unit	41C	
10.5		110 ... 230 AC	2	3RF2310-1AA24	1	1 unit	41C	
20			2	3RF2320-1AA24	1	1 unit	41C	
30			2	3RF2330-1AA24	1	1 unit	41C	
40			2	3RF2340-1AA24	1	1 unit	41C	
50			2	3RF2350-1AA24	1	1 unit	41C	
10.5		4 ... 30 DC	2	3RF2310-1AA44	1	1 unit	41C	
20			2	3RF2320-1AA44	1	1 unit	41C	
30			2	3RF2330-1AA44	1	1 unit	41C	

<sup>1)</sup> The type current provides information about the performance of the solid-state contactor. The actual permitted rated operational current  $I_e$  can be smaller depending on the connection method and installation conditions. For derating characteristic curves, see page 6/63, "More information".

Other rated control supply voltages on request.

## Solid-State Switching Devices for Resistive/Inductive Loads

### Solid-State Contactors

#### SIRIUS 3RF23 solid-state contactors, single-phase

Type current/ performance capacity <sup>1)</sup> $I_{max}$	Rated control supply voltage $U_s$	SD	Screw terminals 	PU (UNIT, SET, M)	PS*	PG
A	V	d	Article No.	Price per PU		
<b>Zero-point switching · Integrated heat sink, rated operational voltage <math>U_e</math> 48 ... 600 V AC</b>						
30	110 ... 230 AC	5	<b>3RF2330-1AA25</b>	1	1 unit	41C
10,5	4 ... 30 DC	5	<b>3RF2310-1AA45</b>	1	1 unit	41C
20		2	<b>3RF2320-1AA45</b>	1	1 unit	41C
30		2	<b>3RF2330-1AA45</b>	1	1 unit	41C
40		2	<b>3RF2340-1AA45</b>	1	1 unit	41C
50		2	<b>3RF2350-1AA45</b>	1	1 unit	41C
<b>Zero-point switching · Integrated heat sink, Blocking voltage 1 600 V, rated operational voltage <math>U_e</math> 48 ... 600 V AC</b>						
10,5	24 DC	5	<b>3RF2310-1AA06</b>	1	1 unit	41C
20		2	<b>3RF2320-1AA06</b>	1	1 unit	41C
30		2	<b>3RF2330-1AA06</b>	1	1 unit	41C
40		5	<b>3RF2340-1AA06</b>	1	1 unit	41C
50		5	<b>3RF2350-1AA06</b>	1	1 unit	41C
10,5	110 ... 230 AC	5	<b>3RF2310-1AA26</b>	1	1 unit	41C
20		5	<b>3RF2320-1AA26</b>	1	1 unit	41C
30		5	<b>3RF2330-1AA26</b>	1	1 unit	41C
40		5	<b>3RF2340-1AA26</b>	1	1 unit	41C
50		5	<b>3RF2350-1AA26</b>	1	1 unit	41C
<b>3RF2340-1</b>						
<b>Low Noise<sup>2)</sup>, Zero-point switching · Integrated heat sink, rated operational voltage <math>U_e</math> 24 ... 230 V AC</b>						
20	24 DC	5	<b>3RF2320-1CA02</b>	1	1 unit	41C
30		5	<b>3RF2330-1CA02</b>	1	1 unit	41C
20	110 ... 230 AC	5	<b>3RF2320-1CA22</b>	1	1 unit	41C
<b>3RF2320-1</b>						
<b>Low Noise<sup>2)</sup>, Zero-point switching · Integrated heat sink, rated operational voltage <math>U_e</math> 48 ... 460 V AC</b>						
20	24 DC	5	<b>3RF2320-1CA04</b>	1	1 unit	41C
20	110 ... 230 AC	5	<b>3RF2320-1CA24</b>	1	1 unit	41C
20	4 ... 30 DC	2	<b>3RF2320-1CA44</b>	1	1 unit	41C
<b>Short-circuit-proof with B MCB · Zero-point switching · Integrated heat sink, rated operational voltage <math>U_e</math> 24 ... 230 V AC</b>						
20	24 DC	2	<b>3RF2320-1DA02</b>	1	1 unit	41C
20	110 ... 230 AC	5	<b>3RF2320-1DA22</b>	1	1 unit	41C
<b>Short-circuit-proof with B MCB · Zero-point switching · Integrated heat sink, rated operational voltage <math>U_e</math> 48 ... 460 V AC</b>						
20	24 DC	2	<b>3RF2320-1DA04</b>	1	1 unit	41C
20	110 ... 230 AC	5	<b>3RF2320-1DA24</b>	1	1 unit	41C
20	4 ... 30 DC	2	<b>3RF2320-1DA44</b>	1	1 unit	41C
30		2	<b>3RF2330-1DA44</b>	1	1 unit	41C
<b>3RF2320-1</b>						

<sup>1)</sup> The type current provides information about the performance of the solid-state contactor. The actual permitted rated operational current  $I_e$  can be smaller depending on the connection method and installation conditions. For derating characteristic curves, see page 6/63, "More information".

<sup>2)</sup> See page 6/77.





Other rated control supply voltages on request.



## Solid-State Switching Devices for Resistive/Inductive Loads

### Solid-State Contactors

#### SIRIUS 3RF23 solid-state contactors, single-phase

	Type current/ performance capacity <sup>1)</sup> $I_{max}$	Operational current $I_e/AC-15^{2)}$	Rated control supply voltage $U_s$	SD	Screw terminals 	PU (UNIT, SET, M)	PS*	PG	
	A	A	V	d	Article No.	Price per PU			
<b>Instantaneous switching · Integrated heat sink, rated operational voltage <math>U_e</math> 24 ... 230 V AC</b>									
 3RF2310-1	10.5	6	24 DC	2	3RF2310-1BA02		1	1 unit 41C	
	20	12		2	3RF2320-1BA02		1	1 unit 41C	
	30	15		5	3RF2330-1BA02		1	1 unit 41C	
	40	20		5	3RF2340-1BA02		1	1 unit 41C	
	50	25		5	3RF2350-1BA02		1	1 unit 41C	
	50	27.5		5	3RF2370-1BA02		1	1 unit 41C	
	10.5	6	110 ... 230 AC	5	3RF2310-1BA22		1	1 unit 41C	
	20	12		5	3RF2320-1BA22		1	1 unit 41C	
	30	15		5	3RF2330-1BA22		1	1 unit 41C	
	40	20		5	3RF2340-1BA22		1	1 unit 41C	
	50	25		5	3RF2350-1BA22		1	1 unit 41C	
	50	27.5		5	3RF2370-1BA22		1	1 unit 41C	
	<b>Instantaneous switching · Integrated heat sink, rated operational voltage <math>U_e</math> 48 ... 460 V AC</b>								
	 3RF2320-1	10.5	6	24 DC	2	3RF2310-1BA04		1	1 unit 41C
20		12		2	3RF2320-1BA04		1	1 unit 41C	
30		15		2	3RF2330-1BA04		1	1 unit 41C	
40		20		5	3RF2340-1BA04		1	1 unit 41C	
50		25		5	3RF2350-1BA04		1	1 unit 41C	
50		27.5		5	3RF2370-1BA04		1	1 unit 41C	
10.5		6	110 ... 230 AC	5	3RF2310-1BA24		1	1 unit 41C	
20		12		5	3RF2320-1BA24		1	1 unit 41C	
30		15		5	3RF2330-1BA24		1	1 unit 41C	
40		20		5	3RF2340-1BA24		1	1 unit 41C	
50		25		5	3RF2350-1BA24		1	1 unit 41C	
50		27.5		5	3RF2370-1BA24		1	1 unit 41C	
20		12	4 ... 30 DC	5	3RF2320-1BA44		1	1 unit 41C	
30		15		5	3RF2330-1BA44		1	1 unit 41C	
50	25		5	3RF2350-1BA44		1	1 unit 41C		
<b>Instantaneous switching · Integrated heat sink, Blocking voltage 1 600 V, rated operational voltage <math>U_e</math> 48 ... 600 V AC</b>									
 3RF2340-1	10.5	6	24 DC	5	3RF2310-1BA06		1	1 unit 41C	
	20	12		2	3RF2320-1BA06		1	1 unit 41C	
	30	15		5	3RF2330-1BA06		1	1 unit 41C	
	40	20		5	3RF2340-1BA06		1	1 unit 41C	
	50	25		5	3RF2350-1BA06		1	1 unit 41C	
	50	27.5		5	3RF2370-1BA06		1	1 unit 41C	
	10.5	6	110 ... 230 AC	5	3RF2310-1BA26		1	1 unit 41C	
	20	12		5	3RF2320-1BA26		1	1 unit 41C	
	30	15		5	3RF2330-1BA26		1	1 unit 41C	
	40	20		5	3RF2340-1BA26		1	1 unit 41C	
	50	25		5	3RF2350-1BA26		1	1 unit 41C	
	50	27.5		5	3RF2370-1BA26		1	1 unit 41C	

<sup>1)</sup> The type current provides information about the performance of the solid-state contactor. The actual permitted rated operational current  $I_e$  can be smaller depending on the connection method and installation conditions. For derating characteristic curves, see page 6/63, "More information".

<sup>2)</sup> Utilization category AC-15:  
Electromagnetic loads, e.g. valves according to IEC 60947-5-1.  
Parameters: max. 1 200 1/h, 50% ON period, 10-times inrush current for 60 ms.

Other rated control supply voltages on request.

## Solid-State Switching Devices for Resistive/Inductive Loads

### Solid-State Contactors

#### SIRIUS 3RF23 solid-state contactors, single-phase

Type current/ performance capacity <sup>1)</sup> $I_{max}$	Rated control supply voltage $U_s$	SD	Spring-type terminals 	PU (UNIT, SET, M)	PS*	PG
A	V	d	Article No.	Price per PU		
<b>Zero-point switching · Integrated heat sink, rated operational voltage <math>U_e</math> 24 ... 230 V AC</b>						
10.5	24 DC	5	<b>3RF2310-2AA02</b>		1	1 unit 41C
20		2	<b>3RF2320-2AA02</b>		1	1 unit 41C
10.5	110 ... 230 AC	5	<b>3RF2310-2AA22</b>		1	1 unit 41C
20		5	<b>3RF2320-2AA22</b>		1	1 unit 41C
<b>Zero-point switching · Integrated heat sink, rated operational voltage <math>U_e</math> 48 ... 460 V AC</b>						
10.5	24 DC	2	<b>3RF2310-2AA04</b>		1	1 unit 41C
20		2	<b>3RF2320-2AA04</b>		1	1 unit 41C
10.5	110 ... 230 AC	5	<b>3RF2310-2AA24</b>		1	1 unit 41C
20		5	<b>3RF2320-2AA24</b>		1	1 unit 41C
<b>Zero-point switching · Integrated heat sink, Blocking voltage 1 600 V, rated operational voltage <math>U_e</math> 48 ... 600 V AC</b>						
10.5	24 DC	5	<b>3RF2310-2AA06</b>		1	1 unit 41C
20		2	<b>3RF2320-2AA06</b>		1	1 unit 41C
10.5	110 ... 230 AC	5	<b>3RF2310-2AA26</b>		1	1 unit 41C
20		5	<b>3RF2320-2AA26</b>		1	1 unit 41C
<b>Low Noise<sup>2)</sup>, Zero-point switching · Integrated heat sink, rated operational voltage <math>U_e</math> 24 ... 230 V AC</b>						
20	24 DC	5	<b>3RF2320-2CA02</b>		1	1 unit 41C
20	110 ... 230 AC	5	<b>3RF2320-2CA22</b>		1	1 unit 41C
<b>Low Noise<sup>2)</sup>, Zero-point switching · Integrated heat sink, rated operational voltage <math>U_e</math> 48 ... 460 V AC</b>						
20	24 DC	5	<b>3RF2320-2CA04</b>		1	1 unit 41C
20	110 ... 230 AC	5	<b>3RF2320-2CA24</b>		1	1 unit 41C
<b>Short-circuit-proof with B MCB, Zero-point switching · Integrated heat sink, rated operational voltage <math>U_e</math> 24 ... 230 V AC</b>						
20	110 ... 230 AC	5	<b>3RF2320-2DA22</b>		1	1 unit 41C
<b>Short-circuit-proof with B MCB, Zero-point switching · Integrated heat sink, rated operational voltage <math>U_e</math> 48 ... 460 V AC</b>						
20	24 DC	5	<b>3RF2320-2DA04</b>		1	1 unit 41C
20	110 ... 230 AC	5	<b>3RF2320-2DA24</b>		1	1 unit 41C



3RF2320-2

<sup>1)</sup> The type current provides information about the performance of the solid-state contactor. The actual permitted rated operational current  $I_e$  can be smaller depending on the connection method and installation conditions. For derating characteristic curves, see page 6/63, "More information".



<sup>2)</sup> See page 6/77.

Other rated control supply voltages on request.

## Solid-State Switching Devices for Resistive/Inductive Loads

### Solid-State Contactors

#### SIRIUS 3RF23 solid-state contactors, single-phase

Type current/ performance capacity <sup>1)</sup> $I_{max}$	Rated control supply voltage $U_s$	SD	Ring terminal lug connection	⊕ Price per PU	PU (UNIT, SET, M)	PS*	PG			
A	V	d	Article No.							
<b>Zero-point switching · Integrated heat sink, rated operational voltage <math>U_e</math> 24 ... 230 V AC</b>										
	10.5	24 DC	5	3RF2310-3AA02		1	1 unit	41C		
	20		5	3RF2320-3AA02		1	1 unit	41C		
	30		5	3RF2330-3AA02		1	1 unit	41C		
	40		5	3RF2340-3AA02		1	1 unit	41C		
	50		5	3RF2350-3AA02		1	1 unit	41C		
	70		2	3RF2370-3AA02		1	1 unit	41C		
	10.5	110 ... 230 AC	5	3RF2310-3AA22		1	1 unit	41C		
	20		5	3RF2320-3AA22		1	1 unit	41C		
	30		5	3RF2330-3AA22		1	1 unit	41C		
	40		5	3RF2340-3AA22		1	1 unit	41C		
	50		5	3RF2350-3AA22		1	1 unit	41C		
	70		5	3RF2370-3AA22		1	1 unit	41C		
	<b>Zero-point switching · Integrated heat sink, rated operational voltage <math>U_e</math> 48 ... 460 V AC</b>									
			10.5	24 DC		5	3RF2310-3AA04		1	1 unit
20		5	3RF2320-3AA04		1	1 unit	41C			
30		2	3RF2330-3AA04		1	1 unit	41C			
40		5	3RF2340-3AA04		1	1 unit	41C			
50		2	3RF2350-3AA04		1	1 unit	41C			
70		2	3RF2370-3AA04		1	1 unit	41C			
10.5		110 ... 230 AC	5	3RF2310-3AA24		1	1 unit	41C		
20			5	3RF2320-3AA24		1	1 unit	41C		
30			5	3RF2330-3AA24		1	1 unit	41C		
40			5	3RF2340-3AA24		1	1 unit	41C		
50			5	3RF2350-3AA24		1	1 unit	41C		
70			5	3RF2370-3AA24		1	1 unit	41C		
20			4 ... 30 DC	5		3RF2320-3AA44		1	1 unit	41C
30				5		3RF2330-3AA44		1	1 unit	41C
50		5		3RF2350-3AA44	1	1 unit		41C		
<b>Zero-point switching · Integrated heat sink, rated operational voltage <math>U_e</math> 48 ... 600 V AC</b>										
40		4 ... 30 DC	5	3RF2340-3AA45		1	1 unit	41C		
70			2	3RF2370-3AA45		1	1 unit	41C		
<b>Zero-point switching · Integrated heat sink, Blocking voltage 1 600 V, rated operational voltage <math>U_e</math> 48 ... 600 V AC</b>										
10.5	24 DC	5	3RF2310-3AA06		1	1 unit	41C			
20		5	3RF2320-3AA06		1	1 unit	41C			
30		5	3RF2330-3AA06		1	1 unit	41C			
40		5	3RF2340-3AA06		1	1 unit	41C			
50		5	3RF2350-3AA06		1	1 unit	41C			
70		5	3RF2370-3AA06		1	1 unit	41C			
10.5	110 ... 230 AC	5	3RF2310-3AA26		1	1 unit	41C			
20		5	3RF2320-3AA26		1	1 unit	41C			
30		5	3RF2330-3AA26		1	1 unit	41C			
40		5	3RF2340-3AA26		1	1 unit	41C			
50		5	3RF2350-3AA26		1	1 unit	41C			
70		5	3RF2370-3AA26		1	1 unit	41C			

<sup>1)</sup> The type current provides information about the performance of the solid-state contactor. The actual permitted rated operational current  $I_e$  can be smaller depending on the connection method and installation conditions. For derating characteristic curves, see page 6/63, "More information".

Other rated control supply voltages on request.

## Solid-State Switching Devices for Resistive/Inductive Loads

### Solid-State Contactors

#### SIRIUS 3RF23 solid-state contactors, single-phase

Type current/ performance capacity <sup>1)</sup> $I_{max}$	Operational current $I_e/AC-15^{2)}$	Rated control supply voltage $U_s$	SD	Ring terminal lug connection 	PU (UNIT, SET, M)	PS*	PG
A	A	V	d	Article No.	Price per PU		
<b>Instantaneous switching · Integrated heat sink, rated operational voltage <math>U_e</math> 24 ... 230 V AC</b>							
70	27.5	24 DC	5	<b>3RF2370-3BA02</b>	1	1 unit	41C
70	27.5	110 ... 230 AC	5	<b>3RF2370-3BA22</b>	1	1 unit	41C
<b>Instantaneous switching · Integrated heat sink, rated operational voltage <math>U_e</math> 48 ... 460 V AC</b>							
70	27.5	24 DC	5	<b>3RF2370-3BA04</b>	1	1 unit	41C
70	27.5	110 ... 230 AC	5	<b>3RF2370-3BA24</b>	1	1 unit	41C
<b>Instantaneous switching · Integrated heat sink, Blocking voltage 1 600 V, rated operational voltage <math>U_e</math> 48 ... 600 V AC</b>							
70	27.5	24 DC	5	<b>3RF2370-3BA06</b>	1	1 unit	41C
70	27.5	110 ... 230 AC	5	<b>3RF2370-3BA26</b>	1	1 unit	41C
<b>Short-circuit-proof with B MCB, Zero-point switching · Integrated heat sink, rated operational voltage <math>U_e</math> 24 ... 230 V AC</b>							
20	--	24 DC	5	<b>3RF2320-3DA02</b>	1	1 unit	41C
20	--	110 ... 230 AC	5	<b>3RF2320-3DA22</b>	1	1 unit	41C
<b>Short-circuit-proof with B MCB, Zero-point switching · Integrated heat sink, rated operational voltage <math>U_e</math> 48 ... 460 V AC</b>							
20	--	24 DC	5	<b>3RF2320-3DA04</b>	1	1 unit	41C
20	--	110 ... 230 AC	5	<b>3RF2320-3DA24</b>	1	1 unit	41C

<sup>1)</sup> The type current provides information about the performance of the solid-state contactor. The actual permitted rated operational current  $I_e$  can be smaller depending on the connection method and installation conditions. For derating characteristic curves, see page 6/63, "More information".

<sup>2)</sup> Utilization category AC-15:  
Electromagnetic loads, e.g. valves according to IEC 60947-5-1.  
Parameters: max. 1 200 1/h, 50% ON period, 10-times inrush current for 60 ms.







Other rated control supply voltages on request.

## Solid-State Switching Devices for Resistive/Inductive Loads

### Solid-State Contactors

#### SIRIUS 3RF23 solid-state contactors, single-phase

#### Accessories

Version	SD	Article No.	Price per PU	PU (UNIT, SET, M)	PS*	PG
	d					
<b>Optional accessories</b>						
 <p><b>Screwdrivers</b> For all SIRIUS devices with spring-type terminals Length approx. 200 mm, size 3.0 mm x 0.5 mm, titanium gray/black, partially insulated</p> <p>3RA2908-1A</p>	2	<b>Spring-type terminals</b>  <b>3RA2908-1A</b>		1	1 unit	41B
		<b>Ring terminal lug connection</b>  <b>3RF2900-3PA88</b>		1	10 units	41C
 <p><b>Terminal covers</b> For 3RF23 solid-state contactors with ring terminal lug connection (With this terminal cover, degree of protection IP20 can be achieved in the terminal compartment in the case of ring terminal lug connections. It can also be used for screw terminals after simple adaptation)</p> <p>3RF2900-3PA88</p>	2					
<b>Control connectors</b>						
		<b>Screw terminals</b>  <b>3RF2900-1TA88</b>		1	50 units	41C
<b>Replacement control connectors</b> For 3RF23/24 Screw terminals	5					
		<b>Spring-type terminals</b>  <b>3RF2900-2TA88</b>		1	50 units	41C
<b>Replacement control connectors</b> For 3RF23/24 Spring-type terminals	5					
		<b>Control connector</b> for 3RF23/24 Spring-type terminals with two clamping points per contact		1	10 units	41C
	5					

## Solid-State Switching Devices for Resistive/Inductive Loads

### Solid-State Contactors

#### SIRIUS 3RF24 solid-state contactors, three-phase

#### Overview

##### Three-phase solid-state contactors with heat sink

Their compact design with optimized heat sink enables small complete units with currents up to 50 A. They also offer all the



special features of the solid-state relay in terms of time and space savings.

#### Technical specifications

##### More information

System Manual "SIRIUS Modular System – System Overview", see <https://support.industry.siemens.com/cs/ww/en/view/60311318>

FAQs, see <https://support.industry.siemens.com/cs/ww/en/ps/16230/faq>

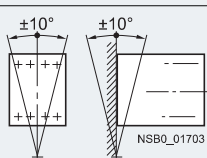
Type		3RF24..-1....	3RF24..-2....	3RF24..-3....
Dimensions (W x H x D)		See page 6/89		
<b>General data</b>				
<b>Ambient temperature</b>				
• During operation, derating from 40 °C	°C	-25 ... +60		
• During storage	°C	-55 ... +80		
<b>Installation altitude</b>	m	0 ... 1 000, derating from 1 000		
<b>Shock resistance</b> acc. to IEC 60068-2-27	g/ms	15/11		
<b>Vibration resistance</b> acc. to IEC 60068-2-6	g	2		
<b>Degree of protection</b>		IP20		IP00
<b>Insulation strength</b> at 50/60 Hz (main/control circuit to floor)	V rms	4 000		
<b>Electromagnetic compatibility (EMC)</b>				
• Emitted interference according to IEC 60947-4-3 - Conducted interference voltage		Class A for industrial applications <sup>1)</sup>		
• Interference immunity - Electrostatic discharge acc. to IEC 61000-4-2 (corresponds to degree of severity 3)	kV	Contact discharge 4; air discharge 8; behavior criterion 2		
- Induced RF fields according to IEC 61000-4-6	MHz	0.15 ... 80; 140 dBµV; behavior criterion 1		
- Burst acc. to IEC 61000-4-4	kV	2/5.0 kHz; behavior criterion 2		
- Surge acc. to IEC 61000-4-5	kV	Conductor - ground 2; conductor - conductor 1; behavior criterion 2		
<b>Connection type</b>		 <b>Screw terminals</b>	 <b>Spring-type terminals</b>	 <b>Ring terminal lug connection</b>
<b>Connection, main contacts</b>				
• Conductor cross-section				
- Solid	mm <sup>2</sup>	2 x (1.5 ... 2.5) <sup>2)</sup> , 2 x (2.5 ... 6) <sup>2)</sup>		2 x (0.5 ... 2.5)
- Finely stranded with end sleeve	mm <sup>2</sup>	2 x (1 ... 2.5) <sup>2)</sup> , 2 x (2.5 ... 6) <sup>2)</sup> , 1 x 10		2 x (0.5 ... 1.5)
- Finely stranded without end sleeve	mm <sup>2</sup>	--		2 x (0.5 ... 2.5)
- Solid or stranded, AWG cables	AWG	2 x (14 ... 10)		2 x (18 ... 14)
• Stripped length	mm	10		10
• Terminal screws		M4		M5
- Tightening torque	Nm	2 ... 2.5		2 ... 2.5
	lb.in	18 ... 22		18 ... 22
• Cable lugs		--		5-2.5 ... 5-25
- According to DIN 46234		--		R 2-5 ... R 14-5
- According to JIS C 2805		--		12
- Width, maximum	mm	--		12
<b>Connection, auxiliary/control contacts</b>				
• Conductor cross-section	mm	1 x (0.5 ... 2.5), 2 x (0.5 ... 1.0)		1 x (0.5 ... 2.5), 2 x (0.5 ... 1.0)
	AWG	20 ... 12		20 ... 12
• Stripped length	mm	7		7
• Terminal screw		M3		M3
- Tightening torque,	Nm	0.5 ... 0.6		0.5 ... 0.6
∅ 3.5, PZ 1	lb.in	4.5 ... 5.3		4.5 ... 5.3
<b>Grounding screw</b> (not included in the scope of supply)				
• Size (standard screw)		M5		
<b>Permissible mounting position</b>				
				

<sup>1)</sup> These products were built as Class A devices. The use of these devices in residential areas could result in lead in radio interference. In this case these may be required to introduce additional interference suppression measures. The versions 3RF24..-1AC55 comply with Class B for residential, business and commercial applications.

<sup>2)</sup> If two different conductor cross-sections are connected to one clamping point, both cross-sections must lie in one of the ranges specified.

## Solid-State Switching Devices for Resistive/Inductive Loads

### Solid-State Contactors

#### SIRIUS 3RF24 solid-state contactors, three-phase

Type	Type current/ performance capacity <sup>1)</sup>	Rated operational current $I_e$		Power loss at $I_{AC-51}$	Minimum load current	Max. off-state current	Rated peak withstand current $I_{tsm}$	$I^2t$ value
	$I_{AC-51}$ at 40 °C	Acc. to IEC 60947-4-3 at 40 °C	Acc. to UL/CSA at 50 °C					
<b>Main circuit</b>								
<b>3RF2410-AB.5</b>	10.5	7		23	0.1	10	200	200
<b>3RF2420-AB.5</b>	22	15		44	0.5	10	600	1800
<b>3RF2430-AB.5</b>	30	22		61	0.5	10	1200	7200
<b>3RF2440-AB.5</b>	40	30		80	0.5	10	1150	6600
<b>3RF2450-AB.5</b>	50	38		107	0.5	10	1150	6600
<b>3RF2410-AC.5</b>	10.5	7		31	0.5	10	300	450
<b>3RF2420-AC.5</b>	22	15		66	0.5	10	600	1800
<b>3RF2430-AC.5</b>	30	22		91	0.5	10	1200	7200
<b>3RF2440-AC.5</b>	40	30		121	0.5	10	1150	6600
<b>3RF2450-AC.5</b>	50	38		160	0.5	10	1150	6600

<sup>1)</sup> The type current provides information about the performance of the solid-state contactor. The actual permitted rated operational current  $I_e$  can be smaller depending on the connection method and installation conditions.

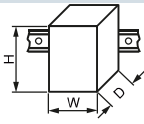
Type	Type current $I_{AC-51}$	Dimensions (W x H x D) (including heat sink)
	A	mm
		
<b>Main circuit</b>		
<b>3RF2410-AB..</b>	10.5	45 x 100 x 105
<b>3RF2410-AC..</b>		
<b>3RF2420-AB..</b>	22	67 x 100 x 112.5
<b>3RF2420-AC..</b>	22	89.5 x 100 x 112.5
<b>3RF2430-AB..</b>	30	

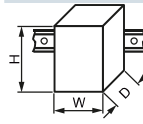
Type	Type current $I_{AC-51}$	Dimensions (W x H x D) (including heat sink)
	A	mm
		
<b>Main circuit</b>		
<b>3RF2430-AC..</b>	30	113.5 x 100 x 121
<b>3RF2440-AB..</b>	40	
<b>3RF2440-AC..</b>	40	157.5 x 100 x 121
<b>3RF2450-AB..</b>	50	
<b>3RF2450-AC..</b>	50	157.5 x 180 x 121

Type		<b>3RF24...-AB.5</b>	<b>3RF24...-AC.5</b>
<b>Main circuit</b>			
<b>Controlled phases</b>		2-phase	3-phase
<b>Rated operational voltage <math>U_e</math></b>	V AC	48 ... 600	
• Operating range	V AC	40 ... 660	
• Rated frequency	Hz	50/60 ± 10%	
<b>Rated insulation voltage <math>U_i</math></b>	V	600	
<b>Rated impulse withstand voltage <math>U_{imp}</math></b>	kV	6	
<b>Blocking voltage</b>	V	1 200	
<b>Rate of voltage rise</b>	V/μs	1 000	



Type		<b>3RF24...-...3.</b>	<b>3RF24...-...4.</b>	<b>3RF24...-...5.</b>
<b>Control circuit</b>				
<b>Method of operation</b>		AC operation	DC operation	AC operation
<b>Rated control supply voltage <math>U_s</math></b>	V	110	4 ... 30	190 ... 230
<b>Rated frequency of the control supply voltage</b>	Hz	50/60 ± 10%	--	50/60 ± 10%
<b>Actuating voltage, max.</b>	V	121	30	253
<b>Typical actuating current</b>	mA	15	30	15
<b>Response voltage</b>	V	90	4	180
<b>Drop-out voltage</b>	V	< 40	< 1	< 40
<b>Operating times</b>				
• ON-delay	ms	40 + max. one half-wave	1 + max. one half-wave	40 + max. one half-wave
• OFF-delay	ms	40 + max. one half-wave	1 + max. one half-wave	40 + max. one half-wave

## Solid-State Switching Devices for Resistive/Inductive Loads

### Solid-State Contactors

#### SIRIUS 3RF24 solid-state contactors, three-phase

##### Selection and ordering data

Type current/ performance capacity <sup>1)</sup> $I_{max}$	Rated control supply voltage $U_s$	SD	Screw terminals	⊕	PU (UNIT, SET, M)	PS*	PG
A	V	d	Article No.		Price per PU		
<b>Zero-point switching · Integrated heat sink, rated operational voltage <math>U_e</math> 48 ... 600 V AC</b>							
<b>Two-phase controlled</b>							
 3RF2420-1AB45	10.5	4 ... 30 DC	2	3RF2410-1AB45	1	1 unit	41C
	20		2	3RF2420-1AB45	1	1 unit	41C
	30		2	3RF2430-1AB45	1	1 unit	41C
	40		5	3RF2440-1AB45	1	1 unit	41C
	50		2	3RF2450-1AB45	1	1 unit	41C
	10.5	110 AC	5	3RF2410-1AB35	1	1 unit	41C
	20		5	3RF2420-1AB35	1	1 unit	41C
	30		5	3RF2430-1AB35	1	1 unit	41C
	40		5	3RF2440-1AB35	1	1 unit	41C
	50		5	3RF2450-1AB35	1	1 unit	41C
	10.5	230 AC	5	3RF2410-1AB55	1	1 unit	41C
	20		5	3RF2420-1AB55	1	1 unit	41C
	30		2	3RF2430-1AB55	1	1 unit	41C
	40		5	3RF2440-1AB55	1	1 unit	41C
	50		5	3RF2450-1AB55	1	1 unit	41C
<b>Three-phase controlled</b>							
 3RF2410-1AC45	10.5	4 ... 30 DC	2	3RF2410-1AC45	1	1 unit	41C
	20		2	3RF2420-1AC45	1	1 unit	41C
	30		2	3RF2430-1AC45	1	1 unit	41C
	40		2	3RF2440-1AC45	1	1 unit	41C
	50		2	3RF2450-1AC45	1	1 unit	41C
	10.5	110 AC	5	3RF2410-1AC35	1	1 unit	41C
	20		5	3RF2420-1AC35	1	1 unit	41C
	30		5	3RF2430-1AC35	1	1 unit	41C
	40		5	3RF2440-1AC35	1	1 unit	41C
	50		5	3RF2450-1AC35	1	1 unit	41C
	10.5	230 AC	5	3RF2410-1AC55	1	1 unit	41C
	20		5	3RF2420-1AC55	1	1 unit	41C
	30		5	3RF2430-1AC55	1	1 unit	41C
	40		5	3RF2440-1AC55	1	1 unit	41C
	50		5	3RF2450-1AC55	1	1 unit	41C

<sup>1)</sup> The type current provides information about the performance of the solid-state contactor. The actual permitted rated operational current  $I_e$  can be smaller depending on the connection method and installation conditions. For derating characteristic curves, see page 6/63, "More information".



## Solid-State Switching Devices for Resistive/Inductive Loads

### Solid-State Contactors

#### SIRIUS 3RF24 solid-state contactors, three-phase

Type current/ performance capacity <sup>1)</sup> $I_{max}$	Rated control supply voltage $U_s$	SD	Spring-type terminals 	PU (UNIT, SET, M)	PS*	PG
A	V	d	Article No.	Price per PU		
<b>Zero-point switching · Integrated heat sink, rated operational voltage <math>U_e</math> 48 ... 600 V AC</b>						
<b>Two-phase controlled</b>						
10	4 ... 30 DC	5	<b>3RF2410-2AB45</b>	1	1 unit	41C
20		5	<b>3RF2420-2AB45</b>	1	1 unit	41C
10	230 AC	5	<b>3RF2410-2AB55</b>	1	1 unit	41C
20		5	<b>3RF2420-2AB55</b>	1	1 unit	41C
<b>Three-phase controlled</b>						
10	4 ... 30 DC	5	<b>3RF2410-2AC45</b>	1	1 unit	41C
20		5	<b>3RF2420-2AC45</b>	1	1 unit	41C
10	230 AC	5	<b>3RF2410-2AC55</b>	1	1 unit	41C
20		5	<b>3RF2420-2AC55</b>	1	1 unit	41C



3RF2410-2AB45

Type current/ performance capacity <sup>1)</sup> $I_{max}$	Rated control supply voltage $U_s$	SD	Ring terminal lug connection 	PU (UNIT, SET, M)	PS*	PG
A	V	d	Article No.	Price per PU		
<b>Zero-point switching · Integrated heat sink, rated operational voltage <math>U_e</math> 48 ... 600 V AC</b>						
<b>Two-phase controlled</b>						
50	4 ... 30 DC	5	<b>3RF2450-3AB45</b>	1	1 unit	41C
50	230 AC	5	<b>3RF2450-3AB55</b>	1	1 unit	41C
<b>Three-phase controlled</b>						
50	4 ... 30 DC	5	<b>3RF2450-3AC45</b>	1	1 unit	41C
50	230 AC	5	<b>3RF2450-3AC55</b>	1	1 unit	41C

<sup>1)</sup> The type current provides information about the performance of the solid-state contactor. The actual permitted rated operational current  $I_e$  can be smaller depending on the connection method and installation conditions. For derating characteristic curves, see page 6/63, "More information".

Accessories, see page 6/87.

## Solid-State Switching Devices for Resistive/Inductive Loads

### Function Modules

#### General data

#### Overview

##### Function modules for SIRIUS 3RF2 solid-state switching devices

A great variety of applications demand an expanded range of functionality. With our function modules, these requirements can be met really easily. The modules are mounted simply by clicking them into place; straight away the necessary connections are made with the solid-state relay or contactor.

The plug-in connection to control the solid-state switching devices can simply remain in use. The external connections have screw terminals.

The following function modules are available:

- Converters
- Load monitoring
- Heating current monitoring
- Power controllers
- Power regulators

With the exception of the converter, the function modules can be used only with single-phase solid-state switching devices.

##### Recommended assignment of the function modules to the 3RF21 single-phase solid-state relays

Type	Accessories					
	Converters	Load monitoring		Heating current monitoring <sup>1)</sup>	Power controllers <sup>1)</sup>	Power regulators <sup>1)</sup>
		Basic	Extended <sup>1)</sup>			
<b>Type current = 20 A</b>						
<b>3RF2120-1A.02</b>	3RF2900-0EA18	3RF2920-0FA08	3RF2920-0GA13	--	3RF2920-0KA13	3RF2920-0HA13
<b>3RF2120-1A.04</b>	3RF2900-0EA18	3RF2920-0FA08	3RF2920-0GA16	3RF2932-0JA16	3RF2920-0KA16	3RF2920-0HA16
<b>3RF2120-1A.22</b>	--	--	3RF2920-0GA33	--	--	--
<b>3RF2120-1A.24</b>	--	--	3RF2920-0GA36	--	--	--
<b>3RF2120-1A.42</b>	3RF2900-0EA18	3RF2920-0FA08	3RF2920-0GA13	--	3RF2920-0KA13	3RF2920-0HA13
<b>3RF2120-1A.45</b>	3RF2900-0EA18	3RF2920-0FA08	3RF2920-0GA16	3RF2932-0JA16	3RF2920-0KA16	3RF2920-0HA16
<b>3RF2120-1B.04</b>	3RF2900-0EA18	3RF2920-0FA08	3RF2920-0GA16	3RF2932-0JA16	3RF2920-0KA16	3RF2920-0HA16
<b>3RF2120-2A.02</b>	3RF2900-0EA18	--	--	--	--	--
<b>3RF2120-2A.04</b>	3RF2900-0EA18	--	--	--	--	--
<b>3RF2120-2A.22</b>	--	--	--	--	--	--
<b>3RF2120-2A.24</b>	--	--	--	--	--	--
<b>3RF2120-2A.42</b>	3RF2900-0EA18	--	--	--	--	--
<b>3RF2120-2A.45</b>	3RF2900-0EA18	--	--	--	--	--
<b>3RF2120-3A.02</b>	3RF2900-0EA18	--	3RF2920-0GA13	--	3RF2920-0KA13	3RF2920-0HA13
<b>3RF2120-3A.04</b>	3RF2900-0EA18	--	3RF2920-0GA16	3RF2932-0JA16	3RF2920-0KA16	3RF2920-0HA16
<b>3RF2120-3A.22</b>	--	--	3RF2920-0GA33	--	3RF2920-0KA13	3RF2920-0HA13
<b>3RF2120-3A.24</b>	--	--	3RF2920-0GA36	--	3RF2920-0KA16	3RF2920-0HA16
<b>Type current = 30 A</b>						
<b>3RF2130-1A.02</b>	3RF2900-0EA18	3RF2920-0FA08	3RF2950-0GA13	--	3RF2950-0KA13	3RF2950-0HA13
<b>3RF2130-1A.04</b>	3RF2900-0EA18	3RF2920-0FA08	3RF2950-0GA16	3RF2932-0JA16	3RF2950-0KA16	3RF2950-0HA16
<b>3RF2130-1A.06</b>	3RF2900-0EA18	3RF2920-0FA08	3RF2950-0GA16	3RF2932-0JA16	3RF2950-0KA16	3RF2950-0HA16
<b>3RF2130-1A.22</b>	--	--	3RF2950-0GA33	--	--	3RF2950-0HA33
<b>3RF2130-1A.24</b>	--	--	3RF2950-0GA36	--	--	3RF2950-0HA36
<b>3RF2130-1A.26</b>	--	--	3RF2950-0GA36	--	--	3RF2950-0HA36
<b>3RF2130-1A.42</b>	3RF2900-0EA18	3RF2920-0FA08	3RF2950-0GA13	--	3RF2950-0KA13	3RF2950-0HA13
<b>3RF2130-1A.45</b>	3RF2900-0EA18	3RF2920-0FA08	3RF2950-0GA16	3RF2932-0JA16	3RF2950-0KA16	3RF2950-0HA16
<b>3RF2130-1B.04</b>	3RF2900-0EA18	3RF2920-0FA08	3RF2950-0GA16	3RF2932-0JA16	3RF2950-0KA16	3RF2950-0HA16
<b>Type current = 50 A</b>						
<b>3RF2150-1A.02</b>	3RF2900-0EA18	3RF2920-0FA08	3RF2950-0GA13	--	3RF2950-0KA13	3RF2950-0HA13
<b>3RF2150-1A.04</b>	3RF2900-0EA18	3RF2920-0FA08	3RF2950-0GA16	3RF2932-0JA16	3RF2950-0KA16	3RF2950-0HA16
<b>3RF2150-1A.06</b>	3RF2900-0EA18	3RF2920-0FA08	3RF2950-0GA16	3RF2932-0JA16	3RF2950-0KA16	3RF2950-0HA16
<b>3RF2150-1A.22</b>	--	--	3RF2950-0GA33	--	--	3RF2950-0HA33
<b>3RF2150-1A.24</b>	--	--	3RF2950-0GA36	--	--	3RF2950-0HA36
<b>3RF2150-1A.26</b>	--	--	3RF2950-0GA36	--	--	3RF2950-0HA36
<b>3RF2150-1A.45</b>	3RF2900-0EA18	3RF2920-0FA08	3RF2950-0GA16	3RF2932-0JA16	3RF2950-0KA16	3RF2950-0HA16
<b>3RF2150-1B.04</b>	3RF2900-0EA18	3RF2920-0FA08	3RF2950-0GA16	3RF2932-0JA16	3RF2950-0KA16	3RF2950-0HA16
<b>3RF2150-1B.06</b>	3RF2900-0EA18	3RF2920-0FA08	3RF2950-0GA16	3RF2932-0JA16	3RF2950-0KA16	3RF2950-0HA16
<b>3RF2150-1B.22</b>	--	--	3RF2950-0GA33	--	--	3RF2950-0HA33
<b>3RF2150-2A.02</b>	3RF2900-0EA18	--	--	--	--	--
<b>3RF2150-2A.04</b>	3RF2900-0EA18	--	--	--	--	--
<b>3RF2150-2A.06</b>	3RF2900-0EA18	--	--	--	--	--
<b>3RF2150-2A.14</b>	3RF2900-0EA18	--	--	--	--	--
<b>3RF2150-2A.22</b>	--	--	--	--	--	--
<b>3RF2150-2A.24</b>	--	--	--	--	--	--
<b>3RF2150-2A.26</b>	--	--	--	--	--	--
<b>3RF2150-3A.02</b>	3RF2900-0EA18	--	3RF2950-0GA13	--	3RF2950-0KA13	3RF2950-0HA13
<b>3RF2150-3A.04</b>	3RF2900-0EA18	--	3RF2950-0GA16	3RF2932-0JA16	3RF2950-0KA16	3RF2950-0HA16
<b>3RF2150-3A.06</b>	3RF2900-0EA18	--	3RF2950-0GA16	3RF2932-0JA16	3RF2950-0KA16	3RF2950-0HA16
<b>3RF2150-3A.22</b>	--	--	3RF2950-0GA33	--	--	3RF2950-0HA33
<b>3RF2150-3A.24</b>	--	--	3RF2950-0GA36	--	--	3RF2950-0HA36
<b>3RF2150-3A.26</b>	--	--	3RF2950-0GA36	--	--	3RF2950-0HA36

<sup>1)</sup> For line voltages in the range from 110 to 230 V, the versions of the 3RF29...-0A13 function modules can also be combined with more voltage-resistant versions of the solid-state relays (3RF21...-...4, -...5 or -...6).

## Solid-State Switching Devices for Resistive/Inductive Loads

### Function Modules

#### General data

Type	Accessories					
	Converters	Load monitoring		Heating current monitoring <sup>1)</sup>	Power controllers <sup>1)</sup>	Power regulators <sup>1)</sup>
		Basic	Extended <sup>1)</sup>			
<b>Type current = 70 A</b>						
<b>3RF2170-1A.02</b>	3RF2900-0EA18	3RF2920-0FA08	3RF2950-0GA13	--	3RF2950-0KA13	3RF2950-0HA13
<b>3RF2170-1A.04</b>	3RF2900-0EA18	3RF2920-0FA08	3RF2950-0GA16	3RF2932-0JA16	3RF2950-0KA16	3RF2950-0HA16
<b>3RF2170-1A.05</b>	3RF2900-0EA18	3RF2920-0FA08	3RF2950-0GA16	3RF2932-0JA16	3RF2950-0KA16	3RF2950-0HA16
<b>3RF2170-1A.06</b>	3RF2900-0EA18	3RF2920-0FA08	3RF2950-0GA16	3RF2932-0JA16	3RF2950-0KA16	3RF2950-0HA16
<b>3RF2170-1A.22</b>	--	--	3RF2950-0GA33	--	--	3RF2950-0HA33
<b>3RF2170-1A.24</b>	--	--	3RF2950-0GA36	--	--	3RF2950-0HA36
<b>3RF2170-1A.26</b>	--	--	3RF2950-0GA36	--	--	3RF2950-0HA36
<b>3RF2170-1A.45</b>	3RF2900-0EA18	3RF2920-0FA08	3RF2950-0GA16	3RF2932-0JA16	3RF2950-0KA16	3RF2950-0HA16
<b>3RF2170-1B.04</b>	3RF2900-0EA18	3RF2920-0FA08	3RF2950-0GA16	3RF2932-0JA16	3RF2950-0KA16	3RF2950-0HA16
<b>3RF2170-1C.04</b>	3RF2900-0EA18	3RF2920-0FA08	3RF2950-0GA16	3RF2932-0JA16	3RF2950-0KA16	3RF2950-0HA16
<b>Type current = 90 A</b>						
<b>3RF2190-1A.02</b>	3RF2900-0EA18	3RF2920-0FA08	3RF2950-0GA13	--	3RF2950-0KA13	3RF2950-0HA13
<b>3RF2190-1A.04</b>	3RF2900-0EA18	3RF2920-0FA08	3RF2950-0GA16	3RF2932-0JA16	3RF2950-0KA16	3RF2950-0HA16
<b>3RF2190-1A.06</b>	3RF2900-0EA18	3RF2920-0FA08	3RF2950-0GA16	3RF2932-0JA16	3RF2950-0KA16	3RF2950-0HA16
<b>3RF2190-1A.22</b>	--	--	3RF2950-0GA33	--	--	3RF2950-0HA33
<b>3RF2190-1A.24</b>	--	--	3RF2950-0GA36	--	--	3RF2950-0HA36
<b>3RF2190-1A.26</b>	--	--	3RF2950-0GA36	--	--	3RF2950-0HA36
<b>3RF2190-1A.45</b>	3RF2900-0EA18	3RF2920-0FA08	3RF2950-0GA16	3RF2932-0JA16	3RF2950-0KA16	3RF2950-0HA16
<b>3RF2190-1B.04</b>	3RF2900-0EA18	3RF2920-0FA08	3RF2950-0GA16	3RF2932-0JA16	3RF2950-0KA16	3RF2950-0HA16
<b>3RF2190-2A.02</b>	3RF2900-0EA18	--	--	--	--	--
<b>3RF2190-2A.04</b>	3RF2900-0EA18	--	--	--	--	--
<b>3RF2190-2A.06</b>	3RF2900-0EA18	--	--	--	--	--
<b>3RF2190-2A.22</b>	--	--	--	--	--	--
<b>3RF2190-2A.24</b>	--	--	--	--	--	--
<b>3RF2190-2A.26</b>	--	--	--	--	--	--
<b>3RF2190-3A.02</b>	3RF2900-0EA18	--	3RF2990-0GA13	--	3RF2990-0KA13	3RF2990-0HA13
<b>3RF2190-3A.04</b>	3RF2900-0EA18	--	3RF2990-0GA16	3RF2932-0JA16	3RF2990-0KA16	3RF2990-0HA16
<b>3RF2190-3A.06</b>	3RF2900-0EA18	--	3RF2990-0GA16	3RF2932-0JA16	3RF2990-0KA16	3RF2990-0HA16
<b>3RF2190-3A.22</b>	--	--	3RF2990-0GA33	--	--	3RF2990-0HA33
<b>3RF2190-3A.24</b>	--	--	3RF2990-0GA36	--	--	3RF2990-0HA36
<b>3RF2190-3A.26</b>	--	--	3RF2990-0GA36	--	--	3RF2990-0HA36
<b>3RF2190-3A.44</b>	3RF2900-0EA18	--	3RF2990-0GA16	3RF2932-0JA16	3RF2990-0KA16	3RF2990-0HA16

<sup>1)</sup> For line voltages in the range from 110 to 230 V, the versions of the 3RF29...-0.A13 function modules can also be combined with more voltage-resistant versions of the solid-state relays (3RF21...-....4 , -....5 or -....6).

#### Recommended assignment of the function modules to the 3RF22 three-phase solid-state relays

Type	Accessories					
	Converters	Load monitoring		Heating current monitoring	Power controllers	Power regulators
		Basic	Extended			
<b>Type current up to 55 A</b>						
<b>3RF22...-1A...</b>	3RF2900-0EA18	--	--	--	--	--
<b>3RF22...-2A...</b>	3RF2900-0EA18	--	--	--	--	--
<b>3RF22...-3A...</b>	3RF2900-0EA18	--	--	--	--	--

#### Recommended assignment of the function modules to the 3RF23 single-phase solid-state contactors

Type	Accessories					
	Converters	Load monitoring		Heating current monitoring <sup>1)</sup>	Power controllers <sup>1)</sup>	Power regulators <sup>1)</sup>
		Basic	Extended <sup>1)</sup>			
<b>Type current <math>I_e = 10.5 A</math></b>						
<b>3RF2310-1A.02</b>	3RF2900-0EA18	3RF2920-0FA08	3RF2920-0GA13	3RF2916-0JA13	3RF2920-0KA13	3RF2920-0HA13
<b>3RF2310-1A.04</b>	3RF2900-0EA18	3RF2920-0FA08	3RF2920-0GA16	3RF2932-0JA16	3RF2920-0KA16	3RF2920-0HA16
<b>3RF2310-1A.06</b>	3RF2900-0EA18	3RF2920-0FA08	3RF2920-0GA16	3RF2932-0JA16	3RF2920-0KA16	3RF2920-0HA16
<b>3RF2310-1A.12</b>	3RF2900-0EA18	--	3RF2920-0GA13	3RF2916-0JA13	3RF2920-0KA13	3RF2920-0HA13
<b>3RF2310-1A.14</b>	3RF2900-0EA18	--	3RF2920-0GA16	3RF2932-0JA16	3RF2920-0KA16	3RF2920-0HA16
<b>3RF2310-1A.22</b>	--	--	3RF2920-0GA33	--	--	3RF2920-0HA33
<b>3RF2310-1A.24</b>	--	--	3RF2920-0GA36	--	--	3RF2920-0HA36
<b>3RF2310-1A.26</b>	--	--	3RF2920-0GA36	--	--	3RF2920-0HA36
<b>3RF2310-1A.44</b>	3RF2900-0EA18	3RF2920-0FA08	3RF2920-0GA16	3RF2932-0JA16	3RF2920-0KA16	3RF2920-0HA16
<b>3RF2310-1A.45</b>	3RF2900-0EA18	3RF2920-0FA08	3RF2920-0GA16	3RF2932-0JA16	3RF2920-0KA16	3RF2920-0HA16

<sup>1)</sup> For line voltages in the range from 110 to 230 V, the versions of the 3RF29...-0.A13 function modules can also be combined with more voltage-resistant versions of the solid-state contactors (3RF23...-....4 , -....5 or -....6).

## Solid-State Switching Devices for Resistive/Inductive Loads

### Function Modules

#### General data

Type	Accessories					
	Converters	Load monitoring		Heating current monitoring <sup>1)</sup>	Power controllers <sup>1)</sup>	Power regulators <sup>1)</sup>
		Basic	Extended <sup>1)</sup>			
<b>Type current <math>I_e = 10.5 \text{ A}</math></b>						
<b>3RF2310-1B.02</b>	3RF2900-0EA18	3RF2920-0FA08	3RF2920-0GA13	3RF2916-0JA13	3RF2920-0KA13	3RF2920-0HA13
<b>3RF2310-1B.04</b>	3RF2900-0EA18	3RF2920-0FA08	3RF2920-0GA16	3RF2932-0JA16	3RF2920-0KA16	3RF2920-0HA16
<b>3RF2310-1B.06</b>	3RF2900-0EA18	3RF2920-0FA08	3RF2920-0GA16	3RF2932-0JA16	3RF2920-0KA16	3RF2920-0HA16
<b>3RF2310-1B.22</b>	--	--	3RF2920-0GA33	--	--	3RF2920-0HA33
<b>3RF2310-1B.24</b>	--	--	3RF2920-0GA36	--	--	3RF2920-0HA36
<b>3RF2310-1B.26</b>	--	--	3RF2920-0GA36	--	--	3RF2920-0HA36
<b>3RF2310-2A.02</b>	3RF2900-0EA18	--	--	--	--	--
<b>3RF2310-2A.04</b>	3RF2900-0EA18	--	--	--	--	--
<b>3RF2310-2A.06</b>	3RF2900-0EA18	--	--	--	--	--
<b>3RF2310-2A.22</b>	--	--	--	--	--	--
<b>3RF2310-2A.24</b>	--	--	--	--	--	--
<b>3RF2310-2A.26</b>	--	--	--	--	--	--
<b>3RF2310-3A.02</b>	3RF2900-0EA18	--	3RF2920-0GA13	3RF2916-0JA13	3RF2920-0KA13	3RF2920-0HA13
<b>3RF2310-3A.04</b>	3RF2900-0EA18	--	3RF2920-0GA16	3RF2932-0JA16	3RF2920-0KA16	3RF2920-0HA16
<b>3RF2310-3A.06</b>	3RF2900-0EA18	--	3RF2920-0GA16	3RF2932-0JA16	3RF2920-0KA16	3RF2920-0HA16
<b>3RF2310-3A.22</b>	--	--	3RF2920-0GA33	--	--	3RF2920-0HA33
<b>3RF2310-3A.24</b>	--	--	3RF2920-0GA36	--	--	3RF2920-0HA36
<b>3RF2310-3A.26</b>	--	--	3RF2920-0GA36	--	--	3RF2920-0HA36
<b>Type current <math>I_e = 20 \text{ A}</math></b>						
<b>3RF2320-1A.02</b>	3RF2900-0EA18	3RF2920-0FA08	3RF2920-0GA13	--	3RF2920-0KA13	3RF2920-0HA13
<b>3RF2320-1A.04</b>	3RF2900-0EA18	3RF2920-0FA08	3RF2920-0GA16	3RF2932-0JA16	3RF2920-0KA16	3RF2920-0HA16
<b>3RF2320-1A.06</b>	3RF2900-0EA18	3RF2920-0FA08	3RF2920-0GA16	3RF2932-0JA16	3RF2920-0KA16	3RF2920-0HA16
<b>3RF2320-1A.14</b>	3RF2900-0EA18	--	3RF2920-0GA16	--	3RF2920-0KA16	3RF2920-0HA16
<b>3RF2320-1A.22</b>	--	--	3RF2920-0GA33	--	--	3RF2920-0HA33
<b>3RF2320-1A.24</b>	--	--	3RF2920-0GA36	--	--	3RF2920-0HA36
<b>3RF2320-1A.26</b>	--	--	3RF2920-0GA36	--	--	3RF2920-0HA36
<b>3RF2320-1A.44</b>	3RF2900-0EA18	3RF2920-0FA08	3RF2920-0GA16	3RF2932-0JA16	3RF2920-0KA16	3RF2920-0HA16
<b>3RF2320-1A.45</b>	3RF2900-0EA18	3RF2920-0FA08	3RF2920-0GA16	3RF2932-0JA16	3RF2920-0KA16	3RF2920-0HA16
<b>3RF2320-1B.02</b>	3RF2900-0EA18	3RF2920-0FA08	3RF2920-0GA13	--	3RF2920-0KA13	3RF2920-0HA13
<b>3RF2320-1B.04</b>	3RF2900-0EA18	3RF2920-0FA08	3RF2920-0GA16	3RF2932-0JA16	3RF2920-0KA16	3RF2920-0HA16
<b>3RF2320-1B.06</b>	3RF2900-0EA18	3RF2920-0FA08	3RF2920-0GA16	3RF2932-0JA16	3RF2920-0KA16	3RF2920-0HA16
<b>3RF2320-1B.22</b>	--	--	3RF2920-0GA33	--	--	3RF2920-0HA33
<b>3RF2320-1B.24</b>	--	--	3RF2920-0GA36	--	--	3RF2920-0HA36
<b>3RF2320-1B.26</b>	--	--	3RF2920-0GA36	--	--	3RF2920-0HA36
<b>3RF2320-1B.44</b>	3RF2900-0EA18	3RF2920-0FA08	3RF2920-0GA16	3RF2932-0JA16	3RF2920-0KA16	3RF2920-0HA16
<b>3RF2320-1C.02</b>	3RF2900-0EA18	3RF2920-0FA08	3RF2920-0GA13	--	3RF2920-0KA13	3RF2920-0HA13
<b>3RF2320-1C.04</b>	3RF2900-0EA18	3RF2920-0FA08	3RF2920-0GA16	3RF2932-0JA16	3RF2920-0KA16	3RF2920-0HA16
<b>3RF2320-1C.22</b>	--	--	3RF2920-0GA33	--	--	3RF2920-0HA33
<b>3RF2320-1C.24</b>	--	--	3RF2920-0GA36	--	--	3RF2920-0HA36
<b>3RF2320-1C.44</b>	3RF2900-0EA18	3RF2920-0FA08	3RF2920-0GA16	3RF2932-0JA16	3RF2920-0KA16	3RF2920-0HA16
<b>3RF2320-1D.02</b>	3RF2900-0EA18	3RF2920-0FA08	3RF2920-0GA13	--	3RF2920-0KA13	3RF2920-0HA13
<b>3RF2320-1D.04</b>	3RF2900-0EA18	3RF2920-0FA08	3RF2920-0GA16	3RF2932-0JA16	3RF2920-0KA16	3RF2920-0HA16
<b>3RF2320-1D.22</b>	--	--	3RF2920-0GA33	--	--	3RF2920-0HA33
<b>3RF2320-1D.24</b>	--	--	3RF2920-0GA36	--	--	3RF2920-0HA36
<b>3RF2320-1D.44</b>	3RF2900-0EA18	3RF2920-0FA08	3RF2920-0GA16	3RF2932-0JA16	3RF2920-0KA16	3RF2920-0HA16
<b>3RF2320-2A.02</b>	3RF2900-0EA18	--	--	--	--	--
<b>3RF2320-2A.04</b>	3RF2900-0EA18	--	--	--	--	--
<b>3RF2320-2A.06</b>	3RF2900-0EA18	--	--	--	--	--
<b>3RF2320-2A.22</b>	--	--	--	--	--	--
<b>3RF2320-2A.24</b>	--	--	--	--	--	--
<b>3RF2320-2A.26</b>	--	--	--	--	--	--
<b>3RF2320-2C.02</b>	3RF2900-0EA18	--	--	--	--	--
<b>3RF2320-2C.04</b>	3RF2900-0EA18	--	--	--	--	--
<b>3RF2320-2C.22</b>	--	--	--	--	--	--
<b>3RF2320-2C.24</b>	--	--	--	--	--	--
<b>3RF2320-2D.22</b>	--	--	--	--	--	--
<b>3RF2320-2D.24</b>	--	--	--	--	--	--
<b>3RF2320-3A.02</b>	3RF2900-0EA18	--	3RF2920-0GA13	--	3RF2920-0KA13	3RF2920-0HA13
<b>3RF2320-3A.04</b>	3RF2900-0EA18	--	3RF2920-0GA16	3RF2932-0JA16	3RF2920-0KA16	3RF2920-0HA16
<b>3RF2320-3A.06</b>	3RF2900-0EA18	--	3RF2920-0GA16	3RF2932-0JA16	3RF2920-0KA16	3RF2920-0HA16
<b>3RF2320-3A.22</b>	--	--	3RF2920-0GA33	--	--	3RF2920-0HA33
<b>3RF2320-3A.24</b>	--	--	3RF2920-0GA36	--	--	3RF2920-0HA36
<b>3RF2320-3A.26</b>	--	--	3RF2920-0GA36	--	--	3RF2920-0HA36
<b>3RF2320-3A.44</b>	3RF2900-0EA18	--	3RF2920-0GA16	3RF2932-0JA16	3RF2920-0KA16	3RF2920-0HA16

<sup>1)</sup> For line voltages in the range from 110 to 230 V, the versions of the 3RF29...-0.A13 function modules can also be combined with more voltage-resistant versions of the solid-state contactors (3RF23...-....4 , ....5 or ....6).

## Solid-State Switching Devices for Resistive/Inductive Loads

### Function Modules

#### General data

Type	Accessories						
	Converters	Load monitoring Basic <sup>1)</sup>		Extended <sup>2)</sup>	Heating current monitoring <sup>2)</sup>	Power controllers <sup>2)</sup>	Power regulators <sup>2)</sup>
<b>Type current <math>I_e = 20\text{ A}</math></b>							
<b>3RF2320-3D.02</b>	3RF2900-0EA18	--		3RF2920-0GA13	--	3RF2920-0KA13	3RF2920-0HA13
<b>3RF2320-3D.04</b>	3RF2900-0EA18	--		3RF2920-0GA16	3RF2932-0JA16	3RF2920-0KA16	3RF2920-0HA16
<b>3RF2320-3D.22</b>	--	--		3RF2920-0GA33	--	--	3RF2920-0HA33
<b>3RF2320-3D.24</b>	--	--		3RF2920-0GA36	--	--	3RF2920-0HA36
<b>Type current <math>I_e = 30\text{ A}</math></b>							
<b>3RF2330-1A.02</b>	3RF2900-0EA18	--		3RF2950-0GA13	--	3RF2950-0KA13	3RF2950-0HA13
<b>3RF2330-1A.04</b>	3RF2900-0EA18	--		3RF2950-0GA16	3RF2932-0JA16	3RF2950-0KA16	3RF2950-0HA16
<b>3RF2330-1A.06</b>	3RF2900-0EA18	--		3RF2950-0GA16	3RF2932-0JA16	3RF2950-0KA16	3RF2950-0HA16
<b>3RF2330-1A.14</b>	3RF2900-0EA18	--		3RF2950-0GA16	3RF2932-0JA16	3RF2950-0KA16	3RF2950-0HA16
<b>3RF2330-1A.22</b>	--	--		3RF2950-0GA33	--	--	3RF2950-0HA33
<b>3RF2330-1A.24</b>	--	--		3RF2950-0GA36	--	--	3RF2950-0HA36
<b>3RF2330-1A.25</b>	--	--		3RF2950-0GA36	--	--	3RF2950-0HA36
<b>3RF2330-1A.26</b>	--	--		3RF2950-0GA36	--	--	3RF2950-0HA36
<b>3RF2330-1A.44</b>	3RF2900-0EA18	--		3RF2950-0GA16	3RF2932-0JA16	3RF2950-0KA16	3RF2950-0HA16
<b>3RF2330-1A.45</b>	3RF2900-0EA18	--		3RF2950-0GA16	3RF2932-0JA16	3RF2950-0KA16	3RF2950-0HA16
<b>3RF2330-1B.02</b>	3RF2900-0EA18	--		3RF2950-0GA13	--	3RF2950-0KA13	3RF2950-0HA13
<b>3RF2330-1B.04</b>	3RF2900-0EA18	--		3RF2950-0GA16	3RF2932-0JA16	3RF2950-0KA16	3RF2950-0HA16
<b>3RF2330-1B.06</b>	3RF2900-0EA18	--		3RF2950-0GA16	3RF2932-0JA16	3RF2950-0KA16	3RF2950-0HA16
<b>3RF2330-1B.22</b>	--	--		3RF2950-0GA33	--	--	3RF2950-0HA33
<b>3RF2330-1B.24</b>	--	--		3RF2950-0GA36	--	--	3RF2950-0HA36
<b>3RF2330-1B.26</b>	--	--		3RF2950-0GA36	--	--	3RF2950-0HA36
<b>3RF2330-1B.44</b>	3RF2900-0EA18	--		3RF2950-0GA16	3RF2932-0JA16	3RF2950-0KA16	3RF2950-0HA16
<b>3RF2330-1C.02</b>	3RF2900-0EA18	--		3RF2950-0GA13	--	--	3RF2950-0HA13
<b>3RF2330-1D.44</b>	3RF2900-0EA18	--		3RF2950-0GA16	3RF2932-0JA16	3RF2950-0KA16	3RF2950-0HA16
<b>3RF2330-3A.02</b>	3RF2900-0EA18	--		3RF2950-0GA13	--	3RF2950-0KA13	3RF2950-0HA13
<b>3RF2330-3A.04</b>	3RF2900-0EA18	--		3RF2950-0GA16	3RF2932-0JA16	3RF2950-0KA16	3RF2950-0HA16
<b>3RF2330-3A.06</b>	3RF2900-0EA18	--		3RF2950-0GA16	3RF2932-0JA16	3RF2950-0KA16	3RF2950-0HA16
<b>3RF2330-3A.22</b>	--	--		3RF2950-0GA33	--	--	3RF2950-0HA33
<b>3RF2330-3A.24</b>	--	--		3RF2950-0GA36	--	--	3RF2950-0HA36
<b>3RF2330-3A.26</b>	--	--		3RF2950-0GA36	--	--	3RF2950-0HA36
<b>3RF2330-3A.44</b>	3RF2900-0EA18	--		3RF2950-0GA16	3RF2932-0JA16	3RF2950-0KA16	3RF2950-0HA16
<b>Type current <math>I_e = 40\text{ A}</math></b>							
<b>3RF2340-1A.02</b>	3RF2900-0EA18	--		3RF2950-0GA13	--	3RF2950-0KA13	3RF2950-0HA13
<b>3RF2340-1A.04</b>	3RF2900-0EA18	--		3RF2950-0GA16	--	3RF2950-0KA16	3RF2950-0HA16
<b>3RF2340-1A.06</b>	3RF2900-0EA18	--		3RF2950-0GA16	--	3RF2950-0KA16	3RF2950-0HA16
<b>3RF2340-1A.14</b>	3RF2900-0EA18	--		3RF2950-0GA16	--	3RF2950-0KA16	3RF2950-0HA16
<b>3RF2340-1A.22</b>	--	--		3RF2950-0GA33	--	--	3RF2950-0HA33
<b>3RF2340-1A.24</b>	--	--		3RF2950-0GA36	--	--	3RF2950-0HA36
<b>3RF2340-1A.26</b>	--	--		3RF2950-0GA36	--	--	3RF2950-0HA36
<b>3RF2340-1A.45</b>	3RF2900-0EA18	--		3RF2950-0GA16	--	3RF2950-0KA16	3RF2950-0HA16
<b>3RF2340-1B.02</b>	3RF2900-0EA18	--		3RF2950-0GA13	--	3RF2950-0KA13	3RF2950-0HA13
<b>3RF2340-1B.04</b>	3RF2900-0EA18	--		3RF2950-0GA13	--	3RF2950-0KA16	3RF2950-0HA16
<b>3RF2340-1B.06</b>	3RF2900-0EA18	--		3RF2950-0GA13	--	3RF2950-0KA16	3RF2950-0HA16
<b>3RF2340-1B.22</b>	--	--		3RF2950-0GA33	--	--	3RF2950-0HA33
<b>3RF2340-1B.24</b>	--	--		3RF2950-0GA36	--	--	3RF2950-0HA36
<b>3RF2340-1B.26</b>	--	--		3RF2950-0GA36	--	--	3RF2950-0HA36
<b>3RF2340-3A.02</b>	3RF2900-0EA18	--		3RF2950-0GA13	--	3RF2950-0KA13	3RF2950-0HA13
<b>3RF2340-3A.04</b>	3RF2900-0EA18	--		3RF2950-0GA16	--	3RF2950-0KA16	3RF2950-0HA16
<b>3RF2340-3A.06</b>	3RF2900-0EA18	--		3RF2950-0GA16	--	3RF2950-0KA16	3RF2950-0HA16
<b>3RF2340-3A.22</b>	--	--		3RF2950-0GA33	--	--	3RF2950-0HA33
<b>3RF2340-3A.24</b>	--	--		3RF2950-0GA36	--	--	3RF2950-0HA36
<b>3RF2340-3A.26</b>	--	--		3RF2950-0GA36	--	--	3RF2950-0HA36
<b>3RF2340-3A.45</b>	3RF2900-0EA18	--		3RF2950-0GA16	--	3RF2950-0KA16	3RF2950-0HA16
<b>Type current <math>I_e = 50\text{ A}</math></b>							
<b>3RF2350-1A.02</b>	3RF2900-0EA18	--		3RF2950-0GA13	--	3RF2950-0KA13	3RF2950-0HA13
<b>3RF2350-1A.04</b>	3RF2900-0EA18	--		3RF2950-0GA16	--	3RF2950-0KA16	3RF2950-0HA16
<b>3RF2350-1A.06</b>	3RF2900-0EA18	--		3RF2950-0GA16	--	3RF2950-0KA16	3RF2950-0HA16
<b>3RF2350-1A.14</b>	3RF2900-0EA18	--		3RF2950-0GA16	--	3RF2950-0KA16	3RF2950-0HA16
<b>3RF2350-1A.22</b>	--	--		3RF2950-0GA33	--	--	3RF2950-0HA33
<b>3RF2350-1A.24</b>	--	--		3RF2950-0GA36	--	--	3RF2950-0HA36
<b>3RF2350-1A.26</b>	--	--		3RF2950-0GA36	--	--	3RF2950-0HA36
<b>3RF2350-1A.45</b>	3RF2900-0EA18	--		3RF2950-0GA16	--	3RF2950-0KA16	3RF2950-0HA16

<sup>1)</sup> The technical specifications must be taken into account when selecting the function modules. More combinations may be possible if the solid-state relays and contactors are not fully loaded, e.g. a load monitor for 20 A can also be operated with a solid-state contactor for 30 A if the load current during operation does not exceed 20 A.

<sup>2)</sup> For line voltages in the range from 110 to 230 V, the versions of the 3RF29...-0.A13 function modules can also be combined with more voltage-resistant versions of the solid-state contactors (3RF23...-...4, -...5 or -...6).

## Solid-State Switching Devices for Resistive/Inductive Loads

### Function Modules

#### General data

Type	Accessories					
	Converters	Load monitoring		Heating current monitoring <sup>1)</sup>	Power controllers <sup>1)</sup>	Power regulators <sup>1)</sup>
		Basic	Extended <sup>1)</sup>			
<b>Type current <math>I_e = 50</math> A</b>						
<b>3RF2350-1B.02</b>	3RF2900-0EA18	--	3RF2950-0GA13	--	3RF2950-0KA13	3RF2950-0HA13
<b>3RF2350-1B.04</b>	3RF2900-0EA18	--	3RF2950-0GA16	--	3RF2950-0KA16	3RF2950-0HA16
<b>3RF2350-1B.06</b>	3RF2900-0EA18	--	3RF2950-0GA16	--	3RF2950-0KA16	3RF2950-0HA16
<b>3RF2350-1B.22</b>	--	--	3RF2950-0GA33	--	--	3RF2950-0HA33
<b>3RF2350-1B.24</b>	--	--	3RF2950-0GA36	--	--	3RF2950-0HA36
<b>3RF2350-1B.26</b>	--	--	3RF2950-0GA36	--	--	3RF2950-0HA36
<b>3RF2350-1B.44</b>	3RF2900-0EA18	--	3RF2950-0GA16	--	3RF2950-0KA16	3RF2950-0HA16
<b>3RF2350-3A.02</b>	3RF2900-0EA18	--	3RF2950-0GA13	--	3RF2950-0KA13	3RF2950-0HA13
<b>3RF2350-3A.04</b>	3RF2900-0EA18	--	3RF2950-0GA16	--	3RF2950-0KA16	3RF2950-0HA16
<b>3RF2350-3A.06</b>	3RF2900-0EA18	--	3RF2950-0GA16	--	3RF2950-0KA16	3RF2950-0HA16
<b>3RF2350-3A.22</b>	--	--	3RF2950-0GA33	--	--	3RF2950-0HA33
<b>3RF2350-3A.24</b>	--	--	3RF2950-0GA36	--	--	3RF2950-0HA36
<b>3RF2350-3A.26</b>	--	--	3RF2950-0GA36	--	--	3RF2950-0HA36
<b>3RF2350-3A.44</b>	3RF2900-0EA18	--	3RF2950-0GA16	--	3RF2950-0KA16	3RF2950-0HA16
<b>Type current <math>I_e = 70</math> A</b>						
<b>3RF2370-1B.02</b>	3RF2900-0EA18	--	3RF2950-0GA13	--	3RF2950-0KA13	3RF2950-0HA13
<b>3RF2370-1B.04</b>	3RF2900-0EA18	--	3RF2950-0GA16	--	3RF2950-0KA16	3RF2950-0HA16
<b>3RF2370-1B.06</b>	3RF2900-0EA18	--	3RF2950-0GA16	--	3RF2950-0KA16	3RF2950-0HA16
<b>3RF2370-1B.22</b>	--	--	3RF2950-0GA33	--	--	3RF2950-0HA33
<b>3RF2370-1B.24</b>	--	--	3RF2950-0GA36	--	--	3RF2950-0HA36
<b>3RF2370-1B.26</b>	--	--	3RF2950-0GA36	--	--	3RF2950-0HA36
<b>3RF2370-3A.02</b>	3RF2900-0EA18	--	3RF2990-0GA13	--	3RF2990-0KA13	3RF2990-0HA13
<b>3RF2370-3A.04</b>	3RF2900-0EA18	--	3RF2990-0GA16	--	3RF2990-0KA16	3RF2990-0HA16
<b>3RF2370-3A.06</b>	3RF2900-0EA18	--	3RF2990-0GA16	--	3RF2990-0KA16	3RF2990-0HA16
<b>3RF2370-3A.22</b>	--	--	3RF2990-0GA33	--	--	3RF2990-0HA33
<b>3RF2370-3A.24</b>	--	--	3RF2990-0GA36	--	--	3RF2990-0HA36
<b>3RF2370-3A.26</b>	--	--	3RF2990-0GA36	--	--	3RF2990-0HA36
<b>3RF2370-3A.45</b>	3RF2900-0EA18	--	3RF2990-0GA16	--	3RF2990-0KA16	3RF2990-0HA16
<b>3RF2370-3B.02</b>	3RF2900-0EA18	--	3RF2990-0GA13	--	3RF2990-0KA13	3RF2990-0HA13
<b>3RF2370-3B.04</b>	3RF2900-0EA18	--	3RF2990-0GA16	--	3RF2990-0KA16	3RF2990-0HA16
<b>3RF2370-3B.06</b>	3RF2900-0EA18	--	3RF2990-0GA16	--	3RF2990-0KA16	3RF2990-0HA16
<b>3RF2370-3B.22</b>	--	--	3RF2990-0GA33	--	--	3RF2990-0HA33
<b>3RF2370-3B.24</b>	--	--	3RF2990-0GA36	--	--	3RF2990-0HA36
<b>3RF2370-3B.26</b>	--	--	3RF2990-0GA36	--	--	3RF2990-0HA36

<sup>1)</sup> For line voltages in the range from 110 to 230 V, the versions of the 3RF29...-0.A13 function modules can also be combined with more voltage-resistant versions of the solid-state contactors (3RF23...-...4, -...5 or -...6).

#### Recommended assignment of the function modules to the 3RF24 three-phase solid-state contactors

Type	Accessories					
	Converters	Load monitoring		Heating current monitoring	Power controllers	Power regulators
		Basic	Extended			
<b>Type current up to 50 A</b>						
<b>3RF24...-1..4.</b>	3RF2900-0EA18	--	--	--	--	--
<b>3RF24...-2..4.</b>	--	--	--	--	--	--
<b>3RF24...-3..4.</b>	3RF2900-0EA18	--	--	--	--	--
<b>3RF24...-...5.</b>	--	--	--	--	--	--

# Solid-State Switching Devices for Resistive/Inductive Loads

## Function Modules

General data

### Technical specifications

#### More information

System Manual "SIRIUS Modular System – System Overview", see <https://support.industry.siemens.com/cs/ww/en/view/60311318>

FAQs, see <https://support.industry.siemens.com/cs/ww/en/ps/16231/faq>

Type		3RF29..-0EA..	3RF29..-0FA..	3RF29..-0GA..	3RF29..-0HA..	3RF29..-0JA..	3RF29..-0KA..
Dimensions (W x H x D)	mm	22.5 x 84 x 38	22.5 x 102 x 39	45 x 112 x 44	45 x 112 x 44	45 x 112 x 44	45 x 112 x 44

#### General data

##### Ambient temperature

• During operation, derating from 40 °C	°C	-25 ... +60
• During storage	°C	-55 ... +80

##### Installation altitude

	m	0 ... 1 000; derating from 1 000
--	---	----------------------------------

##### Shock resistance acc. to IEC 60068-2-27

	g/ms	15/11
--	------	-------

##### Vibration resistance acc. to IEC 60068-2-6

	g	2
--	---	---

##### Degree of protection

		IP20
--	--	------

##### Electromagnetic compatibility (EMC)

• Emitted interference		
- Conducted interference voltage acc. to IEC 60947-4-3		Class A for industrial applications <sup>1)</sup>
- Emitted, high-frequency interference voltage acc. to IEC 60947-4-3		Class B for residential, business and commercial applications
• Interference immunity		
- Electrostatic discharge acc. to IEC 61000-4-2 (corresponds to degree of severity 3)	kV	Contact discharge 4; air discharge 8; behavior criterion 2
- Induced RF fields according to IEC 61000-4-6	MHz	0.15 ... 80; 140 dB $\mu$ V; behavior criterion 1
- Burst acc. to IEC 61000-4-4		2 kV/5.0 kHz; behavior criterion 2
- Surge acc. to IEC 61000-4-5	kV	Conductor - ground 2; conductor - conductor 1; behavior criterion 2

##### Connection type

Auxiliary/control contacts

		 Screw terminals
• Conductor cross-section	mm <sup>2</sup>	1 x (0.5 ... 2.5), 2 x (0.5 ... 1.0), 1 x (AWG 20 ... 12)
• Stripped length	mm	7
• Terminal screw		M3
• Tightening torque	Nm	0.5 ... 0.6
	lb.in	4.5 ... 5.3

##### Connection type

Converters

		 Straight-through transformers
• Diameter	mm	-- 7 17

<sup>1)</sup> Note limitations for power controller and power regulator function modules. These modules were built as Class A devices. The use of these devices in residential areas could result in lead in radio interference. In this case these may be required to introduce additional interference suppression measures.

Type		3RF29..-0EA18	3RF29..-0FA08	3RF29..-0GA.3	3RF29..-0GA.6
------	--	---------------	---------------	---------------	---------------

#### Main circuit

<b>Rated operational voltage <math>U_e</math></b>	V AC	-- <sup>1)</sup>		110 ... 230	400 ... 600
• Operating range	V AC	--		93.5 ... 253	340 ... 660
• Rated frequency	Hz	--		50/60	
<b>Rated insulation voltage <math>U_i</math></b>	V	--		600	
<b>Voltage measuring</b>					
• Measuring range	V	--		93.5 ... 253	340 ... 660
<b>Mains voltage, fluctuation compensation</b>	%	--		20	

<sup>1)</sup> Versions are independent of the main circuit.

Type		3RF29..-0HA.3 3RF29..-0KA.3	3RF29..-0HA.6 3RF29..-0KA.6	3RF29..-0JA.3	3RF29..-0JA.6
------	--	--------------------------------	--------------------------------	---------------	---------------

#### Main circuit

<b>Rated operational voltage <math>U_e</math></b>	V AC	110 ... 230	400 ... 600	110 ... 230	400 ... 600
• Operating range	V AC	93.5 ... 253	340 ... 660	93.5 ... 253	340 ... 660
• Rated frequency	Hz	50/60			
<b>Rated insulation voltage <math>U_i</math></b>	V	600			
<b>Voltage measuring</b>					
• Measuring range	V	93.5 ... 253	340 ... 660	93.5 ... 253	340 ... 660
<b>Mains voltage, fluctuation compensation</b>	%	20			

## Solid-State Switching Devices for Resistive/Inductive Loads

### Function Modules

#### General data

Type		3RF29..-...0.	3RF29..-...1.	3RF29..-...3.
<b>Control circuit</b>				
<b>Method of operation</b>		DC operation	AC/DC operation	AC operation
<b>Rated control supply voltage <math>U_s</math></b>	V	24		110
Rated control current	mA	15		
<b>Rated frequency</b> of the control supply voltage	Hz	--	50/60	
<b>Actuating voltage, max.</b>	V	30		121
<b>Rated control current</b> At maximum voltage	mA	15		
<b>Response voltage</b>	V	15		90
• For operating current	mA	2		
<b>Drop-out voltage</b>	V	5		15

Type		3RF2906-0FA08	3RF2920-0FA08	3RF2920-0GA..	3RF2950-0GA..	3RF2990-0GA..
<b>Current measurement</b>						
<b>Rated operational current <math>I_e</math></b>	A	6	20		50	90
<b>Current measurement</b>						
• Teach range	A	0.25 ... 6	0.65 ... 20	0.56 ... 20	1.62 ... 50	2.93 ... 90
• Measuring range	A	0 ... 6.6	0 ... 22		0 ... 55	0 ... 99
• Minimum partial load current	A	0.25	0.65		1.6	2.9
<b>Number of partial loads</b>		1 ... 6		1 ... 12		

Type		3RF2920-0HA..	3RF2950-0HA..	3RF2990-0HA..	3RF2916-0JA..	3RF2932-0JA..
<b>Current measurement</b>						
<b>Rated operational current <math>I_e</math></b>	A	20	50	90	16	32
<b>Current measurement</b>						
• Teach range	A	4 ... 20	10 ... 50	18 ... 90	0.42 ... 16	0.8 ... 32
• Measuring range	A	0 ... 22	0 ... 55	4 ... 99	0 ... 16	0 ... 32
• Minimum partial load current	A	--			0.42	0.8
<b>Number of partial loads</b>		--			1 ... 6	

Type		3RF2904-0KA..	3RF2920-0KA..	3RF2950-0KA..	3RF2990-0KA..
<b>Current measurement</b>					
<b>Rated operational current <math>I_e</math></b>	A	4	20	50	90
<b>Current measurement</b>					
• Teach range	A	0.15 ... 4	0.65 ... 20	1.6 ... 50	2.9 ... 90
• Measuring range	A	0 ... 4	0 ... 22	0 ... 55	0 ... 99
• Minimum partial load current	A	--	0.65	1.6	2.9
<b>Number of partial loads</b>		--	1 ... 6		



## Solid-State Switching Devices for Resistive/Inductive Loads Function Modules

SIRIUS converters for 3RF2

### Overview

#### Converters for 3RF2 solid-state switching devices

These modules are used to convert analog control signals, such as those output from many temperature controllers for example, into a pulse-width-modulated digital signal. The connected solid-state contactors and relays can therefore regulate the output of a load as a percentage.

### Application

This function module is used for conversions from an analog input signal to an on/off ratio with time basis 1 s. The module can only be used in conjunction with 3RF21 and 3RF23 single-phase solid-state switching devices or 3RF22 and 3RF24 three-phase devices. It can be used on versions with 24 V DC and 24 V AC/DC control supply voltage.

#### Note:

The use of single-pole solid-state switching devices with converters, power controllers or power regulators on AC loads in full-wave control mode is not recommended. Since the function modules do not synchronize with each other, this may lead to fluctuations in the heating power; optimum compensation can no longer be ensured, especially for setpoints < 50%.

### Selection and ordering data

	Rated operational current $I_e$	Rated operational voltage $U_e$	SD	Screw terminals	⊕	PU (UNIT, SET, M)	PS*	PG
	A	V	d	Article No.	Price per PU			
<b>Converters</b>								
		Rated control supply voltage 24 V AC/DC						
3RF2900-0EA18	--	--	2	<b>3RF2900-0EA18</b>		1	1 unit	41C

## Solid-State Switching Devices for Resistive/Inductive Loads

### Function Modules

#### SIRIUS load monitoring for 3RF2

##### Overview

##### Load monitoring for 3RF2 single-phase solid-state switching devices



Many faults can be quickly detected by monitoring a load circuit connected to the solid-state switching device, as made possible with this module. Examples include the failure of load elements (up to 6 in the basic version or up to 12 in the extended version), alloyed power semiconductors, a lack of voltage or a break in a load circuit. A fault is indicated by one or more LEDs and reported to the controller by way of a PLC-compatible output.

The principle of operation is based on permanent monitoring of the current intensity. This figure is continuously compared with the reference value stored once during start up by the simple press of a button. In order to detect the failure of one of several loads, the current difference must be 1/6 (in the basic version) or 1/12 (in the extended version) of the reference value. In the event of a fault, an output is actuated and one or more LEDs indicate the fault.

##### Application

The device is used for monitoring one or more loads (partial loads). The function module can only be used in conjunction with a 3RF21 solid-state relay or a 3RF23 solid-state contactor. The devices with spring-type terminals in the load circuit are not suitable.

##### Selection and ordering data

	Rated operational current $I_e$	Rated operational voltage $U_e$	SD	Screw terminals	⊕	PU (UNIT, SET, M)	PS*	PG
	A	V	d					
<b>Basic load monitoring</b>								
	Rated control supply voltage 24 V DC							
	6	--	2	<b>3RF2906-0FA08</b>		1	1 unit	41C
	20	--	2	<b>3RF2920-0FA08</b>		1	1 unit	41C
	• With mounted 3RF2900-0RA88 cover							
	6	--	2	<b>3RF2906-0FA08-0KH0</b>		1	1 unit	41C
	20	--	2	<b>3RF2920-0FA08-0KH0</b>		1	1 unit	41C
<b>Extended load monitoring</b>								
	Rated control supply voltage 24 V AC/DC							
	20	110 ... 230	2	<b>3RF2920-0GA13</b>		1	1 unit	41C
	20	400 ... 600	2	<b>3RF2920-0GA16</b>		1	1 unit	41C
	50	110 ... 230	2	<b>3RF2950-0GA13</b>		1	1 unit	41C
	50	400 ... 600	2	<b>3RF2950-0GA16</b>		1	1 unit	41C
	90	110 ... 230	2	<b>3RF2990-0GA13</b>		1	1 unit	41C
	90	400 ... 600	2	<b>3RF2990-0GA16</b>		1	1 unit	41C
	Rated control supply voltage 110 V AC							
	20	110 ... 230	2	<b>3RF2920-0GA33</b>		1	1 unit	41C
	20	400 ... 600	2	<b>3RF2920-0GA36</b>		1	1 unit	41C
	50	110 ... 230	2	<b>3RF2950-0GA33</b>		1	1 unit	41C
	50	400 ... 600	2	<b>3RF2950-0GA36</b>		1	1 unit	41C
90	110 ... 230	2	<b>3RF2990-0GA33</b>		1	1 unit	41C	
90	400 ... 600	2	<b>3RF2990-0GA36</b>		1	1 unit	41C	

##### Accessories

	Version	SD	Article No.	Price per PU	PU (UNIT, SET, M)	PS*	PG	
		d						
<b>Optional accessories</b>								
	<b>Sealable covers for function modules</b> (not for converters)		5	<b>3RF2900-0RA88</b>		1	10 units	41C

## Solid-State Switching Devices for Resistive/Inductive Loads

### Function Modules

#### SIRIUS heating current monitoring for 3RF2

#### Overview

##### Heating current monitoring for 3RF2 single-phase solid-state switching devices

Many faults can be quickly detected by monitoring a load circuit connected to the solid-state switching device, as made possible with this module. Examples include the failure of up to six load elements, alloyed power semiconductors, a lack of voltage, or a break in the load circuit. A fault is indicated by LEDs and reported to the controller via relay output (NC).

The principle of operation is based on permanent monitoring of the current intensity. This figure is continuously compared with the reference value stored once during start up. In order to detect the failure of one of several loads, the current difference must be 1/6 of the reference value. In the event of a fault, an output is actuated and the LEDs indicate the fault.

The heating current monitoring has a teach input and therefore differs from the load monitoring. This remote teaching function enables simple adjustment to changing loads without manual intervention.

#### Special version:

##### Deviations from the standard version

3RF29...-0JA1,-1KK0

If the current is below 50% of the lower teach current during the teach routine, the device will go into "Standby" mode; the LOAD LED will flicker. The device thus detects a non-connected load, e.g. channels not required for tool heaters, and does not signal a fault. This mode can be reset by re-teaching.

#### Application

The device is used for monitoring one or more loads (partial loads). The function module can only be used in conjunction with a 3RF21 solid-state relay or a 3RF23 solid-state contactor. The devices with spring-type terminals in the load circuit are not suitable.

#### Selection and ordering data

Rated operational current $I_e$	Rated operational voltage $U_e$	SD	Screw terminals	PU (UNIT, SET, M)	PS*	PG
A	V	d	Article No.	Price per PU		
<b>Heating current monitoring<sup>1)</sup></b>						
Rated control supply voltage 24 V AC/DC						
16	110 ... 230	2	<b>3RF2916-0JA13</b>	1	1 unit	41C
16	110 ... 230	5	<b>3RF2916-0JA13-1KK0</b>	1	1 unit	41C
16	400 ... 600	2	<b>3RF2916-0JA16-1KK0</b>	1	1 unit	41C
32	110 ... 230	2	<b>3RF2932-0JA13-1KK0</b>	1	1 unit	41C
32	400 ... 600	2	<b>3RF2932-0JA16</b>	1	1 unit	41C
32	400 ... 600	2	<b>3RF2932-0JA16-1KK0</b>	1	1 unit	41C



3RF2932-0JA13

<sup>1)</sup> Supplied without control connector. The control connector can be purchased from Phoenix Contact by quoting Article No. 1982 790 (2.5 HC/6-ST-5.08), see page 16/15.

#### Accessories

Version	SD	Article No.	Price per PU	PU (UNIT, SET, M)	PS*	PG
	d					
<b>Optional accessories</b>						
<b>Sealable covers for function modules</b> (not for converters)	5	<b>3RF2900-ORA88</b>		1	10 units	41C



3RF2900-ORA88

## Solid-State Switching Devices for Resistive/Inductive Loads

### Function Modules

#### SIRIUS power controllers for 3RF2

##### Overview

##### Power controllers for 3RF2 single-phase solid-state switching devices

The power controller is a function module for the autonomous power control of complex heating systems and inductive loads.

The following functions have been integrated:

- **Power controller**  
for adjusting the power of the connected load. The setpoint value is selected via a rotary knob on the module as a percentage of the 100% power value stored.
- **Inrush current limitation**  
With the aid of an adjustable voltage ramp, the inrush current is limited by means of phase control. This is useful above all with loads such as lamps or infrared lamps which have an inrush transient current.
- **Load circuit monitoring**  
For detecting load failure, partial load faults, alloyed power semiconductors, lack of voltage or a break in the load circuit.

##### Note:

With the phase control operating mode, a partial load fault is detected by cyclic "scanning" of the load; the exact mode of operation is described in the data sheets!

##### Special version: Deviations from the standard version

##### 3RF2904-0KA13-0KC0

During the teach routine, the connected solid-state relay or contactor is not activated; i.e. no current will flow. No current reference value is stored. No part-load monitoring!

##### 3RF29...-0KA1.-0KT0

No part-load monitoring!

##### Application

The power controller can be used for:

- Complex heating systems
- Inductive loads
- Loads with temperature-dependent resistor
- Loads with ageing after long-time service
- Simple indirect control of temperature

##### Power control

The power controller adjusts the power in the connected load by means of a solid-state switching device depending on the setpoint selection. It does not compensate for changes in the mains voltage or load resistance. The setpoint value can be predefined externally as a 0 to 10 V signal or internally by means of a potentiometer. Depending on the setting of the potentiometer ( $f_R$ ), the control is carried out according to the principle of full-wave control or generalized phase control.

##### Note:

In the case of ohmic loads, the power is set linear to the setpoint value. During operation of inductive loads, the power control is no longer proportional and linear due to the phase shift between current and voltage.

##### Full-wave control

In this operating mode the output is adjusted to the required setpoint value by changing the on-to-off period. The period duration is predefined at 1 s.

See note about AC loads on page 6/99.

##### Generalized phase control

In this operating mode the output is adjusted to the required setpoint value by changing the current flow angle. In order to observe the limit values of the conducted interference voltage for industrial networks, at loads up to 20 kVA, the load circuit must include an additional filter, and for loads above 20 kVA, a reactor with a rating of at least 200  $\mu$ H must be used.

#### Selection and ordering data

Rated operational current $I_e$	Rated operational voltage $U_e$	SD	Screw terminals	⊕	PU (UNIT, SET, M)	PS*	PG	
								Article No.
A	V	d						
<b>Power controllers</b>								
Rated control supply voltage 24 V AC/DC								
4	110 ... 230	2	<b>3RF2904-0KA13-0KC0</b>		1	1 unit	41C	
4		2						<b>3RF2904-0KA13-0KT0</b>
20		2						<b>3RF2920-0KA13</b>
50		2						<b>3RF2950-0KA13</b>
90		2						<b>3RF2990-0KA13</b>
20	400 ... 600	2	<b>3RF2920-0KA16</b>		1	1 unit	41C	
50		2						<b>3RF2950-0KA16</b>
50		2						<b>3RF2950-0KA16-0KT0</b>
90		2						<b>3RF2990-0KA16</b>



3RF2920-0KA13

Version	SD	Article No.	Price per PU	PU (UNIT, SET, M)	PS*	PG

##### Optional accessories



3RF2900-0RA88

<b>Sealable covers for function modules</b> (not for converters)	5	<b>3RF2900-0RA88</b>		1	10 units	41C
---	---	----------------------	--	---	----------	-----

# Solid-State Switching Devices for Resistive/Inductive Loads

## Function Modules

### SIRIUS power regulators for 3RF2

#### Overview

##### Power regulators for 3RF2 single-phase solid-state switching devices

The power regulator is a function module for the autonomous power control of complex heating systems.

The following functions have been integrated:

- **Power controller with proportional-action control**  
For adjusting the power of the connected load. The setpoint value is selected via a rotary knob on the module as a percentage of the 100 % power value stored. Changes in the mains voltage or in the load resistance are compensated in this case.
- **Inrush current limitation**  
With the aid of an adjustable voltage ramp, the inrush current is limited by means of phase control. This is useful above all with loads such as lamps which have an inrush transient current.
- **Load circuit monitoring**  
For detecting load failure, alloyed power semiconductors, lack of voltage or a break in the load circuit. Partial load monitoring is not possible. Load fluctuations are compensated.

#### Application

The power regulator can be used for:

- Complex heating systems
- Heating elements with temperature-dependent resistor
- Heating elements with ageing after long-time service
- Simple indirect control of temperature

#### Power control

The power regulator adjusts the power in the connected load by means of a solid-state switching device depending on the taught power and the selected setpoint. Changes in the mains voltage or in the load resistance are thus compensated by the power regulator. The setpoint value can be predefined externally as a 0 to 10 V signal or internally by means of a potentiometer. Depending on the setting of the potentiometer ( $t_{\text{P}}$ ), the adjustment is carried out according to the principle of full-wave control or generalized phase control.

##### Note:

In the case of ohmic loads, the power is set linear to the setpoint value. During operation of inductive loads, the power control is no longer proportional and linear due to the phase shift between current and voltage.

#### Full-wave control

In this operating mode the output is adjusted to the required setpoint value by changing the on-to-off period. The period duration is predefined at 1 s.

See note about AC loads on page 6/99.

#### Generalized phase control

In this operating mode the output is adjusted to the required setpoint value by changing the current flow angle. In order to observe the limit values of the conducted interference voltage for industrial networks, at loads up to 20 kVA, the load circuit must include an additional filter, and for loads above 20 kVA, a reactor with a rating of at least 200  $\mu\text{H}$  must be used.

#### Selection and ordering data

	Rated operational current $I_e$	Rated operational voltage $U_e$	SD	Screw terminals	PU (UNIT, SET, M)	PS*	PG
A		V	d				
<b>Power regulators</b>							
 3RF2920-0HA13	Rated control supply voltage 24 V AC/DC						
	20	110 ... 230	2	<b>3RF2920-0HA13</b>	1	1 unit	41C
	20	400 ... 600	2	<b>3RF2920-0HA16</b>	1	1 unit	41C
	50	110 ... 230	2	<b>3RF2950-0HA13</b>	1	1 unit	41C
	50	400 ... 600	2	<b>3RF2950-0HA16</b>	1	1 unit	41C
	90	110 ... 230	2	<b>3RF2990-0HA13</b>	1	1 unit	41C
	90	400 ... 600	2	<b>3RF2990-0HA16</b>	1	1 unit	41C
	Rated control supply voltage 110 V AC						
	20	110 ... 230	2	<b>3RF2920-0HA33</b>	1	1 unit	41C
	20	400 ... 600	2	<b>3RF2920-0HA36</b>	1	1 unit	41C
	50	110 ... 230	2	<b>3RF2950-0HA33</b>	1	1 unit	41C
	50	400 ... 600	2	<b>3RF2950-0HA36</b>	1	1 unit	41C
	90	110 ... 230	2	<b>3RF2990-0HA33</b>	1	1 unit	41C
	90	400 ... 600	2	<b>3RF2990-0HA36</b>	1	1 unit	41C

#### Accessories

	Version	SD	Article No.	Price per PU	PU (UNIT, SET, M)	PS*	PG
<b>Optional accessories</b>							
 3RF2900-0RA88	<b>Sealable covers for function modules</b> (not for converters)		5	<b>3RF2900-0RA88</b>	1	10 units	41C

\* You can order this quantity or a multiple thereof.  
Illustrations are approximate

## Solid-State Switching Devices for Switching Motors

### Solid-State Contactors

#### General data

#### Overview

##### More information

Homepage, see [www.siemens.com/solid-state-switching-devices](http://www.siemens.com/solid-state-switching-devices)  
 Industry Mall, see [www.siemens.com/product?3RF](http://www.siemens.com/product?3RF)

Online configurator, see [www.siemens.com/sirius/configurators](http://www.siemens.com/sirius/configurators)

#### Solid-state contactors for switching motors



Solid-state contactor for direct-on-line starting

The solid-state contactors for switching motors are intended for frequently switching on and off three-phase current operating mechanisms up to 7.5 kW and reversing up to 3.0 kW. The devices are constructed with complete insulation and can be mounted directly on SIRIUS motor starter protectors, overload relays and current monitoring relays, resulting in a very simple integration into motor feeders.

These three-phase solid-state contactors are equipped with a two-phase control which is particularly suitable for typical motor current circuits without connecting to the neutral conductor.

Important features:

- Insulated enclosure with integrated heat sink
- Degree of protection IP20
- Integrated mounting foot to snap on a standard mounting rail or for assembly onto a support plate
- Variety of connection methods
- Plug-in control connection
- Display via LEDs
- Wide voltage range for AC control supply voltage

#### Switching functions

The solid-state contactors for switching motors are "instantaneous switching", because this method is particularly suited for inductive loads. By distributing the ON point over the entire sine curve of the mains voltage, disturbances are reduced to a minimum.

#### Connection methods

You can choose between the following connection methods for the solid-state contactors for switching motors:

##### Screw terminals

The screw connection system is the standard among industrial controls. Open terminals and a plus-minus screw are just two features of this technology. Two conductors of up to 6 mm<sup>2</sup> can be connected in just one terminal.

##### Spring-type terminals

This innovative technology manages without any screw connection. This means that very high vibration resistance is achieved. Two conductors of up to 2.5 mm<sup>2</sup> can be connected to each terminal.

#### Motor feeders

The devices can use a link module to directly connect to a motor starter protector. Also possible is the mounting of a 3RB30/3RB31 electronic overload relay (see page 7/94) or a 3RR2 current monitoring relay (see pages 10/64 and 10/72) using a link adapter. The simultaneous mounting of a motor starter protector and an overload or current monitoring relay is not recommended for space and heat development reasons.

Rapid-switching fuseless and fuse motor feeders can thereby be implemented in a time-saving manner.

#### Selecting solid-state contactors

The solid-state contactors are selected on the basis of details of the network, the load and the ambient conditions.

The following procedure is recommended:

- Determine the rated current of the load and the mains voltage
- Select a solid-state contactor with the same or higher rated current than the load
- Testing of the maximum permissible switching frequency based on the characteristic curves (see "More information" → "Product Information"). To do this, the starting current, the starting time and the motor loaded in in the operating phase must be known.
- If the permissible switching frequency is under the desired frequency, it is possible to achieve an increase only by overdimensioning the motor and the solid-state contactor!

Alternatively, the tool for "Selection of solid-state contactors for switching motors" can be used. The correct device size can be determined by entering the network and motor data along with the application and ambient conditions, see [www.siemens.com/solid-state-switching-devices](http://www.siemens.com/solid-state-switching-devices).

#### Short-circuit protection

Despite the rugged power semiconductors that are used, solid-state switching devices respond more sensitively to short circuits in the load feeder. Consequently, special precautions have to be taken against destruction, depending on the type of design.

Siemens generally recommends using SITOR semiconductor fuses. These fuses also provide protection against destruction in the event of a short circuit even when the solid-state contactors and solid-state relays are fully utilized.

Alternatively, if there is lower loading, protection can also be provided by standard fuses or miniature circuit breakers. This protection is achieved by overdimensioning the solid-state switching devices accordingly.

## Solid-State Switching Devices for Switching Motors Solid-State Contactors

General data

### Online Configurator

- Simple selection of individual solid-state switching devices by means of technical characteristics (e.g. zero-point switching, spring-type terminal and rated current)
  - Once configuration is complete, you receive the article numbers corresponding to the products
- see [www.siemens.com/sirius/configurators](http://www.siemens.com/sirius/configurators)

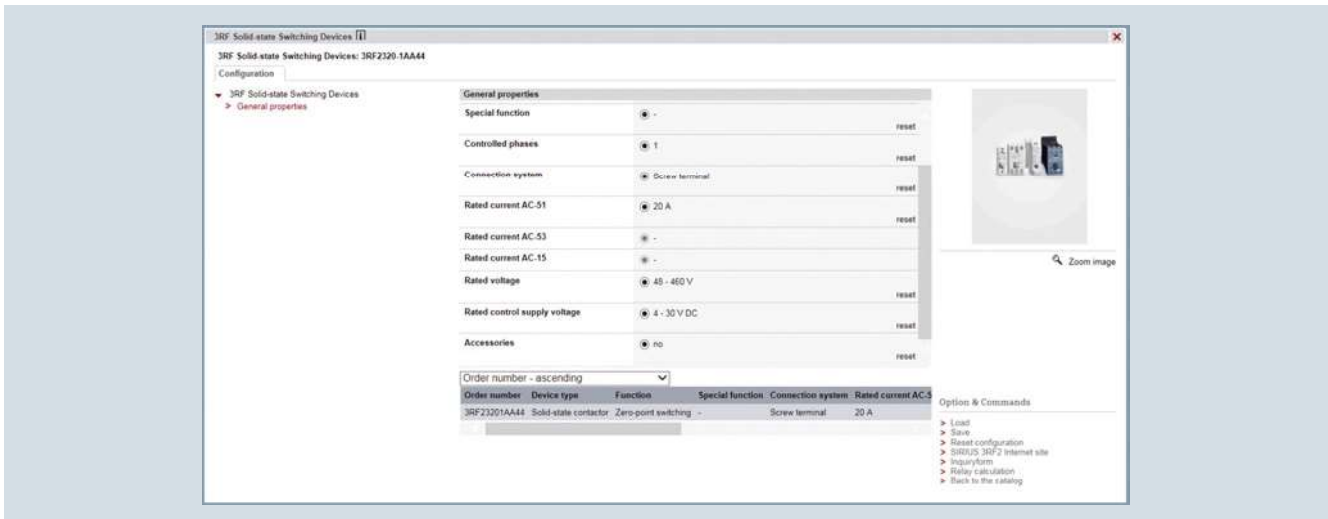

### Article No. scheme

Product versions		Article number								
<b>Solid-state contactors</b>		<b>3RF34</b>	<input type="checkbox"/>	<input type="checkbox"/>	<input type="checkbox"/>	<input type="checkbox"/>	<input type="checkbox"/>	Three-phase		
Rated operational current	3.8 A	<b>0 3</b>	<input type="checkbox"/>	<input type="checkbox"/>	<input type="checkbox"/>	<input type="checkbox"/>	<input type="checkbox"/>	Only for reversing contactor		
	5.2 A (5.4 A for reversing contactor)	<b>0 5</b>	<input type="checkbox"/>	<input type="checkbox"/>	<input type="checkbox"/>	<input type="checkbox"/>	<input type="checkbox"/>			
	9.2 A (7.4 A for reversing contactor)	<b>1 0</b>	<input type="checkbox"/>	<input type="checkbox"/>	<input type="checkbox"/>	<input type="checkbox"/>	<input type="checkbox"/>			
	12.5 A	<b>1 2</b>	<input type="checkbox"/>	<input type="checkbox"/>	<input type="checkbox"/>	<input type="checkbox"/>	<input type="checkbox"/>	Only for solid-state contactor		
	16 A	<b>1 6</b>	<input type="checkbox"/>	<input type="checkbox"/>	<input type="checkbox"/>	<input type="checkbox"/>	<input type="checkbox"/>	Only for solid-state contactor		
Connection type	Screw terminals		<b>1</b>	<input type="checkbox"/>	<input type="checkbox"/>	<input type="checkbox"/>	<input type="checkbox"/>			
	Spring-type terminals		<b>2</b>	<input type="checkbox"/>	<input type="checkbox"/>	<input type="checkbox"/>	<input type="checkbox"/>			
Switching function	Instantaneous switching			<b>B</b>	<input type="checkbox"/>	<input type="checkbox"/>	<input type="checkbox"/>			
Number of controlled phases	2-phase				<b>B</b>	<input type="checkbox"/>	<input type="checkbox"/>			
	Reversing contactor				<b>D</b>	<input type="checkbox"/>	<input type="checkbox"/>			
Rated control supply voltage $U_s$	24 V DC					<b>0</b>	<input type="checkbox"/>			
	110 ... 230 V AC					<b>2</b>	<input type="checkbox"/>			
Rated operational voltage $U_e$	48 ... 460 V AC						<b>4</b>			
	48 ... 600 V AC						<b>6</b>	Blocking voltage 1 600 V, solid-state contactor only		
Example		<b>3RF34</b>	<b>1</b>	<b>0</b>	<b>-</b>	<b>1</b>	<b>B</b>	<b>B</b>	<b>0</b>	<b>4</b>

### Note:

The Article No. scheme shows an overview of product versions for better understanding of the logic behind the article numbers.

For your orders please use the article numbers quoted in the selection and ordering data.



## Solid-State Switching Devices for Switching Motors

### Solid-State Contactors

#### General data

##### Benefits

- Units with integrated heat sink, "ready to use"
- Compact and space-saving design
- Reversing contactors with integrated interlocking

##### Application

###### *Use in load feeders*

There is no typical design of a load feeder with solid-state relays or solid-state contactors; instead, the great variety of connection methods and control voltages offers universal application opportunities.

SIRIUS solid-state relays and solid-state contactors can be installed in fuseless or fused feeders, as required.

See Configuration Manual "Load feeders – Configuring the SIRIUS Modular System – Selection data for Fuseless and Fused Load Feeders",  
<https://support.industry.siemens.com/cs/ww/en/view/39714188>.

###### *Standards and approvals*

- IEC 60947-4-2
- UL 508, CSA for North America<sup>1)</sup>
- CE marking for Europe
- C-Tick approval for Australia
- CCC approval for China

<sup>1)</sup> Please note: Use overvoltage protection device;  
max. cut-off-voltage 6 000 V;  
min. energy handling capability 100 J.



# Solid-State Switching Devices for Switching Motors



## Solid-State Contactors

General data

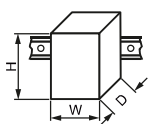
### Technical specifications

Type		<b>3RF3405-1BB..</b> <b>3RF3403-1BD..</b> <b>3RF3405-1BD..</b>	<b>3RF3410-1BB..</b> <b>3RF3412-1BB..</b> <b>3RF3416-1BB..</b> <b>3RF3410-1BD..</b>	<b>3RF3405-2BB..</b>	<b>3RF3410-2BB..</b> <b>3RF3412-2BB..</b> <b>3RF3416-2BB..</b>
Dimensions (W x H x D)		mm 45 x 95 x 96.5 mm 45 x 95 x 108.5	90 x 95 x 96.5 90 x 95 x 108.5	45 x 95 x 96.5 --	90 x 95 x 96.5 --

### General technical specifications

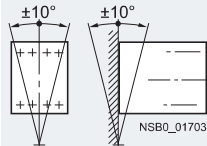
<b>Ambient temperature</b>					
• During operation, derating from 40 °C	°C	-25 ... +60			
• During storage	°C	-55 ... +80			
<b>Installation altitude</b>	m	0 ... 1 000; derating over 1 000 m on request			
<b>Shock resistance</b> acc. to IEC 60068-2-27	g/ms	15/11			
<b>Vibration resistance</b> acc. to IEC 60068-2-6	g	2			
<b>Degree of protection</b>		IP20			
<b>Insulation strength</b> at 50/60 Hz (main/control circuit to floor)	V rms	4 000			
<b>Electromagnetic compatibility (EMC)</b>					
• Emitted interference according to IEC 60947-4-2					
- Conducted interference voltage			Class A for industrial applications <sup>1)</sup>		
- Emitted, high-frequency interference voltage			Class A for industrial applications		
• Interference immunity					
- Electrostatic discharge acc. to IEC 61000-4-2 (corresponds to degree of severity 3)	kV	Contact discharge: 4; air discharge: 8; Behavior criterion 2			
- Induced RF fields according to IEC 61000-4-6	MHz	0.15 ... 80; 140 dBµV; behavior criterion 1			
- Burst acc. to IEC 61000-4-4	kV	2; at 5 kHz; behavior criterion 2			
- Surge acc. to IEC 61000-4-5 <sup>2)</sup>	kV	Conductor - ground: 2; conductor - conductor: 1; behavior criterion 2			
<b>Connection type</b>		 <b>Screw terminals</b>	 <b>Spring-type terminals</b>		
<b>Operating devices</b>		Standard screwdriver size 2 and Pozidriv 2		3.0 x 0.5 and 3.5 x 0.5	
<b>Conductor cross-sections, main contacts</b>					
• Solid	mm <sup>2</sup>	2 x (1.5 ... 2.5) <sup>3)</sup> , 2 x (2.5 ... 6) <sup>3)</sup>		2 x (0.5 ... 2.5)	
• Finely stranded with end sleeve	mm <sup>2</sup>	2 x (1 ... 2.5) <sup>3)</sup> , 2 x (2.5 ... 6) <sup>3)</sup> , 1 x 10		2 x (0.5 ... 1.5)	
• Finely stranded without end sleeve	mm <sup>2</sup>	--		2 x (0.5 ... 2.5)	
• AWG cables, solid or stranded	AWG	2 x (14 ... 10)		2 x (18 ... 14)	
<b>Conductor cross-sections, auxiliary/control contacts</b>					
• With/without end sleeve	mm <sup>2</sup>	1 x (0.5 ... 2.5), 2 x (0.5 ... 1.0)		0.5 ... 2.5	
• AWG cables, solid or stranded	AWG	20 ... 12		20 ... 12	
<b>Permissible mounting position</b>					

<sup>1)</sup> These products were built as Class A devices. The use of these devices in residential areas could result in lead in radio interference. In this case these may be required to introduce additional interference suppression measures.

<sup>2)</sup> The following applies for reversing contactors: To maintain the values, a 3TX7462-3L surge suppressor should be used between phases L1 and L3 as close as possible to the reversing contactor.

<sup>3)</sup> If two different conductor cross-sections are connected to one clamping point, both cross-sections must lie in one of the ranges specified.

### More information

For more information, see

- System Manual "SIRIUS Modular System – System Overview", <https://support.industry.siemens.com/cs/WW/en/view/60311318>
- Manual "SIRIUS 3RF34 Solid-State Switching Devices", <https://support.industry.siemens.com/cs/ww/en/view/60298187>

### Product information and technical specifications

For product data sheets with detailed technical specifications, dimensional drawings and characteristic curves, see <https://support.industry.siemens.com/cs/ww/en/ps/16237>.

For additional information, please enter the article number of the required device under the tab "Product List".

## Solid-State Switching Devices for Switching Motors

### Solid-State Contactors

#### 3RF34 solid-state contactors, three-phase

##### Overview

These two-phase controlled, instantaneous switching solid-state contactors in the insulating enclosure are offered in a width of 45 mm up to 5.2 A – and in a width of 90 mm up to 16 A. They allow the operation of motors up to 7.5 kW.<sup>1)</sup>

- <sup>1)</sup> In accordance with the product standard IEC 60947-4-2, the motor contactors are designed for motors with maximum starting current conditions of  $I/I_e \leq 8$ .  
For configuring motors with higher starting current conditions (typically  $I/I_e \geq 8$ ) the data in the manual "SIRIUS 3RF34 Solid-State Switching Devices" must be taken into account, see <https://support.industry.siemens.com/cs/ww/en/view/60298187>.

##### Technical specifications

###### More information

System Manual "SIRIUS Modular System – System Overview", see <https://support.industry.siemens.com/cs/ww/en/view/60311318>

FAQs, see <https://support.industry.siemens.com/cs/ww/en/ps/16239/faq>

Manual "SIRIUS 3RF34 Solid-State Switching Devices", see <https://support.industry.siemens.com/cs/ww/en/view/60298187>

Type		3RF3405-.BB..	3RF3410-.BB..	3RF3412-.BB..	3RF3416-.BB..
<b>Fuseless design with 3RV2 motor starter protector, CLASS 10</b>					
<b>Rated operational current <math>I_{AC-53a}</math><sup>1)</sup></b> acc. to IEC 60947-4-2					
• At 40 °C	A	5.2 (4.5)	9.2	12.5	16
• UL/CSA, at 50 °C	A	4.6 (4.0)	8.4	11.5	14
• At 60 °C	A	4.2 (3.5)	7.6	10.5	12.5
<b>Power loss at <math>I_{AC-53a}</math></b>					
• At 40 °C	W	10 (8)	16	22	28
<b>Short-circuit protection with type of coordination "1"</b> at operational voltage $U_e$ up to 440 V					
• Motor starter protector, type		3RV2011-1GA10	3RV2011-1JA10	3RV2011-1KA10	3RV2011-4AA10
• Current $I_q$	kA	50	5		3

- <sup>1)</sup> The reduced values in brackets apply to a directly mounted motor starter protector and simultaneous side-by-side mounting.

Type		3RF3405-.BB.4	3RF3405-.BB.6	3RF3410-.BB..	3RF3412-.BB.4	3RF3412-.BB.6	3RF3416-.BB..
<b>Fused design with directly connected 3RB3 overload relay</b>							
<b>Rated operational current <math>I_{AC-53a}</math></b> acc. to IEC 60947-4-2							
• At 40 °C	A	4		7.8	9.5		11
• UL/CSA, at 50 °C	A	3.6		7	8.5		10
• At 60 °C	A	3.2		6.2	7.6		9
<b>Power loss at <math>I_{AC-53a}</math></b>							
• At 40 °C	W	7		13	16		18
<b>Minimum load current</b>	A	0.1	0.5				
<b>Max. off-state current</b>	mA	10					
<b>Rated peak withstand current <math>I_{tsm}</math></b>	A	200	600		1 200	1 150	
<b><math>I^2t</math> value</b>	A <sup>2</sup> s	200	1 800		7 200	6 600	

## Solid-State Switching Devices for Switching Motors

### Solid-State Contactors

#### 3RF34 solid-state contactors, three-phase

Type		3RF34...-BB.4	3RF34...-BB.6
<b>Main circuit</b>			
<b>Controlled phases</b>		Two-phase	
<b>Rated operational voltage <math>U_e</math></b>	V AC	48 ... 480	48 ... 600
• Operating range	V AC	40 ... 506	40 ... 660
• Rated frequency	Hz	50/60 ± 10%	
<b>Rated insulation voltage <math>U_i</math></b>	V	600	
<b>Rated impulse withstand voltage <math>U_{imp}</math></b>	kV	6	
<b>Blocking voltage</b>	V	1 200	1 600
<b>Rate of voltage rise</b>	V/μs	1 000	

Type		3RF34...-BB0.	3RF34...-BB2.
<b>Control circuit</b>			
<b>Method of operation</b>		DC operation	AC operation
<b>Rated control supply voltage <math>U_s</math></b>	V	24	110 ... 230
<b>Rated frequency of the control supply voltage</b>	Hz	--	50/60 ± 10%
<b>Control supply voltage, max.</b>	V	30	253
<b>Typical actuating current</b>	mA	20	15
<b>Response voltage</b>	V	15	90
<b>Drop-out voltage</b>	V	5	< 40
<b>Operating times</b>			
• ON-delay	ms	1	5
• OFF-delay	ms	1 + max. one half-wave	30 + max. one half-wave

## Solid-State Switching Devices for Switching Motors

### Solid-State Contactors

**3RF34 solid-state contactors, three-phase** **IE3/IE4 ready**





#### Selection and ordering data

##### More information

 System Manual "SIRIUS Modular System – System Overview", see <https://support.industry.siemens.com/cs/ww/en/view/60311318>

 Manual "SIRIUS 3RF34 Solid-State Switching Devices", see <https://support.industry.siemens.com/cs/ww/en/view/60298187>

#### Motor contactors · Instantaneous switching · Two-phase controlled







Rated operational current $I_e$	Rated power at $I_e$ and $U_e$	Rated control supply voltage $U_s$	SD	Screw terminals		PU (UNIT, SET, M)	PS*	PG
				Article No.	Price per PU			
A	400 V kW	V	d					
<b>Rated operational voltage <math>U_e</math></b>								
<b>48 ... 480 V AC</b>								
	5.2	2.2	24 DC	2	<b>3RF3405-1BB04</b>	1	1 unit	41C
	9.2	4.0		5	<b>3RF3410-1BB04</b>	1	1 unit	41C
	12.5	5.5		5	<b>3RF3412-1BB04</b>	1	1 unit	41C
	16	7.5		5	<b>3RF3416-1BB04</b>	1	1 unit	41C
	5.2	2.2	110 ... 230 AC	5	<b>3RF3405-1BB24</b>	1	1 unit	41C
	9.2	4.0		5	<b>3RF3410-1BB24</b>	1	1 unit	41C
	12.5	5.5		5	<b>3RF3412-1BB24</b>	1	1 unit	41C
	16	7.5		5	<b>3RF3416-1BB24</b>	1	1 unit	41C
<b>Rated operational voltage <math>U_e</math></b>								
<b>48 ... 600 V AC, blocking voltage 1 600 V</b>								
	5.2	2.2	24 DC	5	<b>3RF3405-1BB06</b>	1	1 unit	41C
	9.2	4.0		5	<b>3RF3410-1BB06</b>	1	1 unit	41C
	12.5	5.5		5	<b>3RF3412-1BB06</b>	1	1 unit	41C
	16	7.5		5	<b>3RF3416-1BB06</b>	1	1 unit	41C
	5.2	2.2	110 ... 230 AC	5	<b>3RF3405-1BB26</b>	1	1 unit	41C
	9.2	4.0		5	<b>3RF3410-1BB26</b>	1	1 unit	41C
	12.5	5.5		5	<b>3RF3412-1BB26</b>	1	1 unit	41C
	16	7.5		5	<b>3RF3416-1BB26</b>	1	1 unit	41C
<b>Rated operational voltage <math>U_e</math></b>								
<b>48 ... 480 V AC</b>								
	5.2	2.2	24 DC	5	<b>3RF3405-2BB04</b>	1	1 unit	41C
	9.2	4.0		5	<b>3RF3410-2BB04</b>	1	1 unit	41C
	12.5	5.5		5	<b>3RF3412-2BB04</b>	1	1 unit	41C
	16	7.5		5	<b>3RF3416-2BB04</b>	1	1 unit	41C
	5.2	2.2	110 ... 230 AC	5	<b>3RF3405-2BB24</b>	1	1 unit	41C
	9.2	4.0		5	<b>3RF3410-2BB24</b>	1	1 unit	41C
	12.5	5.5		5	<b>3RF3412-2BB24</b>	1	1 unit	41C
	16	7.5		5	<b>3RF3416-2BB24</b>	1	1 unit	41C
<b>Rated operational voltage <math>U_e</math></b>								
<b>48 ... 600 V AC, blocking voltage 1 600 V</b>								
	5.2	2.2	24 DC	5	<b>3RF3405-2BB06</b>	1	1 unit	41C
	9.2	4.0		5	<b>3RF3410-2BB06</b>	1	1 unit	41C
	12.5	5.5		5	<b>3RF3412-2BB06</b>	1	1 unit	41C
	16	7.5		5	<b>3RF3416-2BB06</b>	1	1 unit	41C
	5.2	2.2	110 ... 230 AC	5	<b>3RF3405-2BB26</b>	1	1 unit	41C
	9.2	4.0		5	<b>3RF3410-2BB26</b>	1	1 unit	41C
	12.5	5.5		5	<b>3RF3412-2BB26</b>	1	1 unit	41C
	16	7.5		5	<b>3RF3416-2BB26</b>	1	1 unit	41C

## Solid-State Switching Devices for Switching Motors

### Solid-State Contactors

#### 3RF34 solid-state contactors, three-phase

#### Accessories

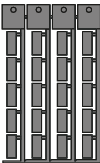
Version	SD	Article No.	Price per PU	PU (UNIT, SET, M)	PS*	PG
<b>Link modules between solid-state contactor and motor starter protector</b>						
		<b>Link modules</b> Between solid-state contactor and motor starter protector with screw terminals For 3RV2 motor starter protectors size S00/S0	<b>Screw terminals</b> 			
3RA2921-1BA00	2	<b>3RA2921-1BA00</b>		1	1 unit	41B
<b>Link adapters between solid-state contactor and overload relay</b>						
		<b>Link adapters</b> For direct mounting of 3RB3 overload relays or 3RR2 current monitoring relays to the solid-state contactor with screw terminals The adapter is snapped onto the enclosure of the 3RF34 contactor and accommodates the fixing hooks of the 3RB3 overload relays or the 3RR2 current monitoring relays for direct mounting.				
3RF3900-0QA88	2	<b>3RF3900-0QA88</b>		1	1 unit	41C
<b>Insulation stop for securely holding back the conductor insulation, on conductors up to 1 mm<sup>2</sup></b>						
		<b>Insulation stop strip</b> For all SIRIUS devices with spring-type terminals Can be inserted in cable entry of the spring-type terminal (no more than 2 strips per contactor required; removable in pairs) For terminals with a conductor cross-section up to 2.5 mm <sup>2</sup>	<b>Spring-type terminals</b> 			
3RT2916-4JA02	5	<b>3RT2916-4JA02</b>		1	20 units	41B
<b>Tools for opening spring-type terminals</b>						
		<b>Screwdrivers</b> For all SIRIUS devices with spring-type terminals Length approx. 200 mm, size 3.0 mm x 0.5 mm, titanium gray/black, partially insulated				
3RA2908-1A	2	<b>3RA2908-1A</b>		1	1 unit	41B
<b>Blank labels</b>						
		<b>Unit labeling plates</b> For SIRIUS devices <sup>1)</sup>				
	20	<b>3RT2900-1SB10</b>		100	816 units	41B
	20	<b>3RT2900-1SB20</b>		100	340 units	41B
		<b>Adhesive labels</b> For SIRIUS devices				
	5	<b>3RT2900-1SB60</b>		100	3 060 units	41B

<sup>1)</sup> PC labeling system for individual inscription of unit labeling plates available from: murrplastik Systemtechnik GmbH, see page 16/15.

## Solid-State Switching Devices for Switching Motors

### Solid-State Contactors

#### 3RF34 solid-state reversing contactors, three-phase

##### Overview

The integration of four conducting paths to a reverse switch, combined in one enclosure makes this device a particularly compact solution. Compared to conventional systems, for which two contactors are required, it is possible to save up to 50% in

width with the 3-phase reversing contactors. Devices with a width of 45 mm cover motors up to 2.2 kW – and those with a width of 90 mm cover motors up to 3 kW.<sup>1)</sup>

<sup>1)</sup> In accordance with the product standard IEC 60947-4-2, the motor contactors are designed for motors with maximum starting current conditions of  $I/I_e \leq 8$ .  
For configuring motors with higher starting current conditions (typically  $I/I_e \geq 8$ ) the data in the manual "SIRIUS 3RF34 Solid-State Switching Devices" must be taken into account, see <https://support.industry.siemens.com/cs/ww/en/view/60298187>.

##### Technical specifications

###### More information

System Manual "SIRIUS Modular System – System Overview", see <https://support.industry.siemens.com/cs/ww/en/view/60311318>  
Manual "SIRIUS 3RF34 Solid-State Switching Devices", see <https://support.industry.siemens.com/cs/ww/en/view/60298187>

FAQs, see <https://support.industry.siemens.com/cs/ww/en/ps/16241/faq>

Type		3RF3403-.BD.4	3RF3405-.BD.4	3RF3410-.BD.4
<b>Fuseless design with 3RV2 motor starter protector, CLASS 10</b>				
<b>Rated operational current <math>I_{AC-53a}</math><sup>1)</sup></b> acc. to IEC 60947-4-2				
• At 40 °C	A	3.8 (3.4)	5.4 (4.8)	7.4
• UL/CSA, at 50 °C	A	3.5 (3.1)	5 (4.3)	6.8
• At 60 °C	A	3.2 (2.8)	4.6 (3.8)	6.2
<b>Power loss at <math>I_{AC-53a}</math></b>				
• At 40 °C	W	7 (6)	9 (8)	13
<b>Short-circuit protection with type of coordination "1"</b> at operational voltage $U_e$ up to 440 V				
• Motor starter protector, type		3RV2011-1FA10	3RV2011-1GA10	3RV2011-1JA10
• Current $I_q$	kA	50		10

<sup>1)</sup> The reduced values in brackets apply to a directly mounted motor starter protector and simultaneous side-by-side mounting.

Type		3RF3403-.BD.4	3RF3405-.BD.4	3RF3410-.BD.4
<b>Fused design with directly connected 3RB3 overload relay</b>				
<b>Rated operational current <math>I_{AC-53a}</math></b> acc. to IEC 60947-4-2				
• At 40 °C	A	3.8	5.4	7.4
• UL/CSA, at 50 °C	A	3.5	5	6.8
• At 60 °C	A	3.2	4.6	6.2
<b>Power loss at <math>I_{AC-53a}</math></b>				
• At 40 °C	W	6	8	16
<b>Minimum load current</b>	A	0.5		
<b>Max. off-state current</b>	mA	10		
<b>Rated peak withstand current <math>I_{tsm}</math></b>	A	200	600	
<b><math>i^2t</math> value</b>	A <sup>2</sup> s	200	1 800	

## Solid-State Switching Devices for Switching Motors

### Solid-State Contactors

#### 3RF34 solid-state reversing contactors, three-phase

Type	<b>3RF34...BD.4</b>	
<b>Main circuit</b>		
<b>Controlled phases</b>	Two-phase	
<b>Rated operational voltage <math>U_e</math><sup>1)</sup></b>	V AC	48 ... 480
• Operating range	V AC	40 ... 506
• Rated frequency	Hz	50/60 ± 10%
<b>Rated insulation voltage <math>U_i</math></b>	V	600
<b>Rated impulse withstand voltage <math>U_{imp}</math></b>	kV	6
<b>Blocking voltage</b>	V	1 200
<b>Rate of voltage rise</b>	V/μs	1 000

<sup>1)</sup> To reduce the risk of a phase short circuit due to overvoltage, we recommend using a varistor type 3TX7462-3L between the phases L1 and L3 as close as possible to the switchgear.

We recommend a design with semiconductor protection as short-circuit protection.

Type	<b>3RF34...BD0.</b>	<b>3RF34...BD2.</b>
<b>Control circuit</b>		
<b>Method of operation</b>	DC operation	AC operation
<b>Rated control supply voltage <math>U_s</math></b>	V	24
<b>Rated frequency of the control supply voltage</b>	Hz	--
<b>Control supply voltage, maximum</b>	V	30
<b>Typical actuating current</b>	mA	15
<b>Response voltage</b>	V	15
<b>Drop-out voltage</b>	V	5
<b>Operating times<sup>1)</sup></b>		
• ON-delay	ms	5
• OFF-delay	ms	5 + max. one half-wave
• Interlocking time	ms	60 ... 100
		20
		10 + max. one half-wave
		50 ... 100

<sup>1)</sup> Caution! Risk of phase short circuit in automatic mode. The control inputs must not be actuated until a delay of 40 ms has expired after the main voltage is applied.



## Solid-State Switching Devices for Switching Motors

### Solid-State Contactors



**3RF34 solid-state reversing contactors, three-phase** **IE3/IE4 ready**

#### Selection and ordering data

##### Reversing contactors · Instantaneous switching · Two-phase controlled

	Rated operational current $I_e$	Rated power at $I_e$ and $U_e$	Rated control supply voltage $U_s$	SD	Screw terminals	PU (UNIT, SET, M)	PS*	PG
	A	400 V kW	V	d	Article No.			
<b>Rated operational voltage <math>U_e</math> 48 ... 480 V AC</b>								
	3.8	<b>1.5</b>	24 DC	2	<b>3RF3403-1BD04</b>	1	1 unit	41C
	5.4	<b>2.2</b>		5				41C
	7.4	<b>3.0</b>		5				41C
	3.8	<b>1.5</b>	110 ... 230 AC	5	<b>3RF3403-1BD24</b>	1	1 unit	41C
	5.4	<b>2.2</b>		5				41C
	7.4	<b>3.0</b>		5				41C

#### Accessories

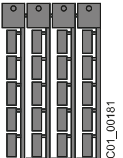
Version	SD	Article No.	Price per PU	PU (UNIT, SET, M)	PS*	PG
<b>Link modules between solid-state contactor and motor starter protector</b>						
	2	<b>3RA2921-1BA00</b>		1	1 unit	41B
<b>Link adapters between solid-state contactor and overload relay</b>						
	2	<b>3RF3900-0QA88</b>		1	1 unit	41C
<b>Blank labels</b>						
	20	<b>3RT2900-1SB10</b>		100	816 units	41B
	20	<b>3RT2900-1SB20</b>		100	340 units	41B
	5	<b>3RT2900-1SB60</b>		100	3 060 units	41B

<sup>1)</sup> PC labeling system for individual inscription of unit labeling plates available from: murrplastik Systemtechnik GmbH, see page 16/15.



## X-ON Electronics

Largest Supplier of Electrical and Electronic Components

*Click to view similar products for [Siemens](#) manufacturer:*

Other Similar products are found below :

[5ST2144](#) [5ST2167](#) [5SX2125-7](#) [5SX2340-7](#) [5SX9200](#) [5VD5401](#) [6EP1332-1SH41](#) [6EP1436-3BA00](#) [6EP1931-2DC21](#) [6ES5451-7LA11](#)  
[D11CEU1](#) [FP9556](#) [PD63F160](#) [FXD63B175](#) [8WA1011-1BH23](#) [8WA1011-2SF25](#) [8WA1721](#) [8WA8848-0AC](#) [8WA8-848-0AM](#) [8WA8-848-0AN](#) [8WA8-848-0AT](#) [8WA8-848-0AX](#) [8WA8-848-0BD](#) [8WA8-848-0BF](#) [8WA8-848-0BL](#) [8WA8-848-0BP](#) [8WA8-848-0BQ](#) [14DP32AC81](#)  
[ED21B100](#) [B32523-.47@400V-J](#) [B65541-T25-A48](#) [B65812-B1512-T1](#) [B66317-G0000-X127](#) [B66337-G0500-X127](#) [B66417-G-X167](#)  
[B82724-J](#) [8WA1201](#) [8WA1854](#) [8WA1870](#) [8WA8-848-0AK](#) [8WA8-848-0AV](#) [8WA8-848-0BG](#) [8WA8-848-0BJ](#) [8WA8-848-0BK](#) [8WA8-848-0BM](#) [8WD4400-1AB](#) [8WD4400-1AC](#) [8WD4420-0EA](#) [RTD14024-S](#) [SAB8259AP](#)