

## High Efficiency, 3.0A, 18V Input Synchronous Step Down Regulator

### General Description

The SM8103 is a high efficiency, 500kHz synchronous step-down DC/DC regulator capable of delivering up to 3A load current. It can operate over a wide input voltage range from 4.2V to 18V and integrate main switch and synchronous switch with very low  $R_{DS(ON)}$  to minimize the conduction loss.

The SM8103 adopts the instant PWM architecture to achieve fast transient responses for high step down applications and high efficiency at light loads. In addition, it operates at pseudo-constant frequency of 500kHz to minimize the size of the inductor and the capacitor.

### Ordering Information

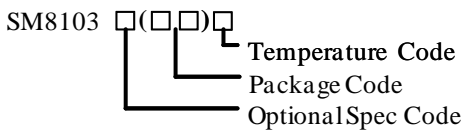

Ordering Number	Package type	Note
SM8103ADC	TSOT23-6	----

### Features

- Low  $R_{DS(ON)}$  for Internal Switches (Top/Bottom): 90mΩ/50mΩ
- 4.2-18V Input Voltage Range
- 3A Output Current Capability
- 500kHz Switching Frequency Minimize the External Components
- Stable with 10 μF  $C_{OUT}$  and 2.2 μH Inductor
- Instant PWM Architecture to Achieve Fast Transient Responses
- Internal Soft-start Limits the Inrush Current
- Cycle-by-cycle Peak/Valley Current Limitation
- Hic-cup Mode Output Short Circuit Protection
- Thermal Shutdown with Auto Recovery
- Output Auto Discharge Function
- Compact Package: TSOT23-6

### Applications

- Set Top Box
- Portable TV
- DSL Modem
- LCD TV
- IP CAM
- Networking

### Typical Application

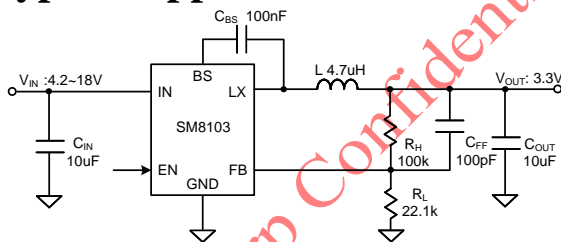

Figure1. Schematic Diagram

Inductor and  $C_{OUT}$  Selection Table

$V_{OUT}$ [V]	L [μH]	$C_{OUT}$ [μF]		
		4.7	10	22
1.2	1.5			✓
	2.2			☆
3.3	2.2		✓	✓
	4.7		☆	✓
5	3.3		✓	✓
	6.8		☆	✓

Note: '☆' means recommended for most applications.

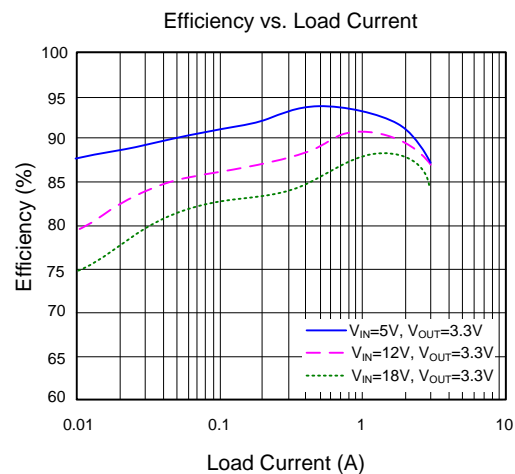
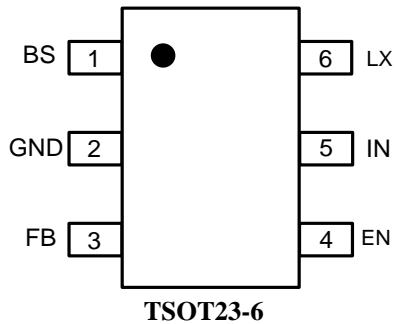

Figure2. Efficiency vs. Output Current

## Pinout (top view)



Top mark: **J7xyz** (Device code: J7, x=year code, y=week code, z=lot number code)

Pin Name	Pin Number	Pin Description
BS	1	Boot-strap pin. Supply high side gate driver. Connect a 0.1 μF ceramic capacitor between BS and LX pins.
GND	2	Power ground pin.
FB	3	Output feedback pin. Connect this pin to the center point of the output resistor divider (as shown in Figure 1) to program the output voltage: $V_{OUT}=0.6 \times (1+R_H/R_L)$ .
EN	4	Enable control. Pull high to turn on. Do not leave this pin floating.
IN	5	Input pin. Decouple this pin to GND pin with at least a 10 μF ceramic capacitor.
LX	6	Inductor pin. Connect this pin to the switching node of inductor.

## Block Diagram

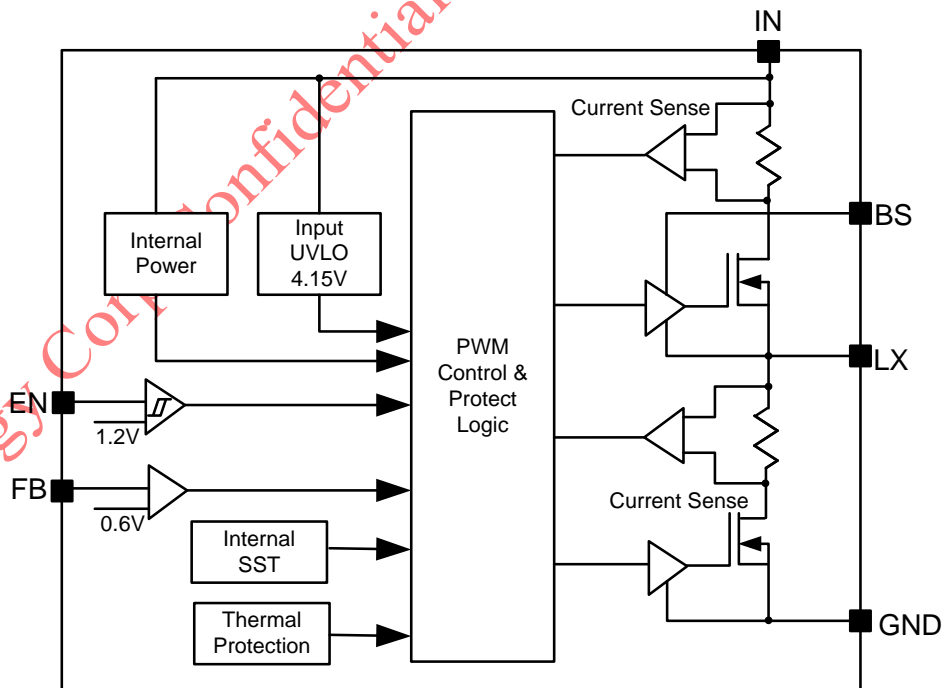

**Figure3. Block Diagram**

**Absolute Maximum Ratings** (Note 1)

Supply Input Voltage	-----	-0.3V to 19V
LX, EN Voltage	-----	-0.3V to $V_{IN} + 0.3V$
FB, BS-LX Voltage	-----	-0.3V to 4V
Power Dissipation, $P_D$ @ $T_A = 25\text{ }^\circ\text{C}$ TSOT23-6,	-----	1.5W
Package Thermal Resistance (Note 2)		
$\theta_{JA}$	-----	66 $^\circ\text{C/W}$
$\theta_{JC}$	-----	15 $^\circ\text{C/W}$
Junction Temperature Range	-----	-40 $^\circ\text{C}$ to 150 $^\circ\text{C}$
Lead Temperature (Soldering, 10 sec.)	-----	260 $^\circ\text{C}$
Storage Temperature Range	-----	-65 $^\circ\text{C}$ to 150 $^\circ\text{C}$
Dynamic LX Voltage in 10ns Duration (Note3)	-----	IN+3V to GND-5V

**Recommended Operating Conditions** (Note 3)

Supply Input Voltage	-----	4.2V to 18V
Junction Temperature Range	-----	-40 $^\circ\text{C}$ to 125 $^\circ\text{C}$
Ambient Temperature Range	-----	-40 $^\circ\text{C}$ to 85 $^\circ\text{C}$

Silergy Corp Confidential Prepared for

## Electrical Characteristics

( $V_{IN} = 12V$ ,  $V_{OUT} = 3.3V$ ,  $L = 4.7 \mu H$ ,  $C_{OUT} = 10 \mu F$ ,  $T_A = 25 \text{ }^\circ C$ ,  $I_{OUT} = 1A$  unless otherwise specified)

Parameter	Symbol	Test Conditions	Min	Typ	Max	Unit
Input Voltage Range	$V_{IN}$		4.2		18	V
Input UVLO Threshold	$V_{UVLO}$				4.15	V
Input UVLO Hysteresis	$V_{HYS}$			0.3		V
Quiescent Current	$I_Q$	$I_{OUT}=0$ , $V_{FB}=V_{REF}\times 105\%$		250		$\mu A$
Shutdown Current	$I_{SHDN}$	EN=0		5	10	$\mu A$
Feedback Reference Voltage	$V_{REF}$		588	600	612	mV
FB Input Current	$I_{FB}$	$V_{FB}=3.3V$	-50		50	nA
Output Discharge Resistance	$R_{DIS}$			40		$\Omega$
Top FET $R_{ON}$	$R_{DS(ON)1}$			90		m $\Omega$
Bottom FET $R_{ON}$	$R_{DS(ON)2}$			50		m $\Omega$
EN Rising Threshold	$V_{EN,R}$		1.08	1.2	1.32	V
EN Falling Threshold	$V_{EN,F}$		0.9	1.0	1.1	V
Min ON Time	$t_{ON,MIN}$			50		ns
Min OFF Time	$t_{OFF,MIN}$			200		ns
Turn On Delay	$t_{ON,DLY}$	from EN high to LX start switching		300		$\mu s$
Soft-start Time	$t_{SS}$	$V_{OUT}$ from 0 to 100%	0.5	1	1.5	ms
Switching Frequency	$F_{SW}$	$V_{OUT}=3.3V$ , CCM		500		kHz
Top FET Current Limit	$I_{LIM, TOP}$		4.5			A
Bottom FET Current Limit	$I_{LIM, BOT}$		3			A
Output Under Voltage Protection Threshold	$V_{UVP}$			33%		$V_{REF}$
Output UVP Delay	$t_{UVP,DLY}$			100		$\mu s$
UVP Hiccup ON Time	$t_{UVP, ON}$			2		ms
UVP Hiccup OFF Time	$t_{UVP, OFF}$			6		ms
Thermal Shutdown Temperature	$T_{SD}$			150		$^\circ C$
Thermal Shutdown Hysteresis	$T_{HYS}$			15		$^\circ C$

**Note 1:** Stresses beyond the “Absolute Maximum Ratings” may cause permanent damage to the device. These are stress ratings only. Functional operation of the device at these or any other conditions beyond those indicated in the operational sections of the specification is not implied. Exposure to absolute maximum rating conditions for extended periods may affect device reliability.

**Note 2:**  $\theta_{JA}$  is measured in the natural convection at  $T_A = 25 \text{ }^\circ C$  on a 2OZ two-layer Silergy evaluation board. Paddle of TSOT23-6 package is the case position for SM8103  $\theta_{JC}$  measurement.

**Note 3:** The device is not guaranteed to function outside its operating conditions.

## Typical Performance Characteristics

Efficiency vs. Load Current

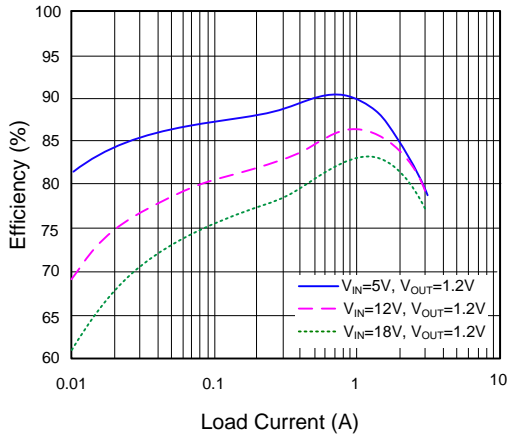

Efficiency vs. Load Current

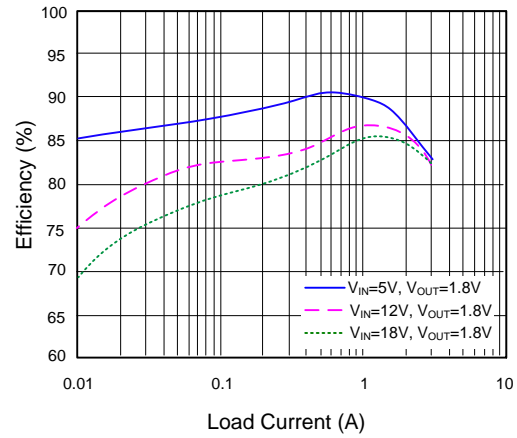

Efficiency vs. Load Current

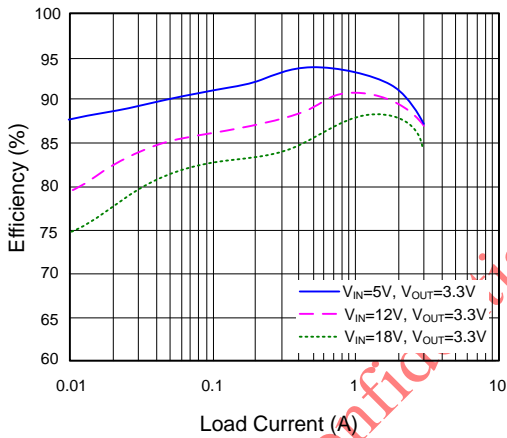

Efficiency vs. Load Current

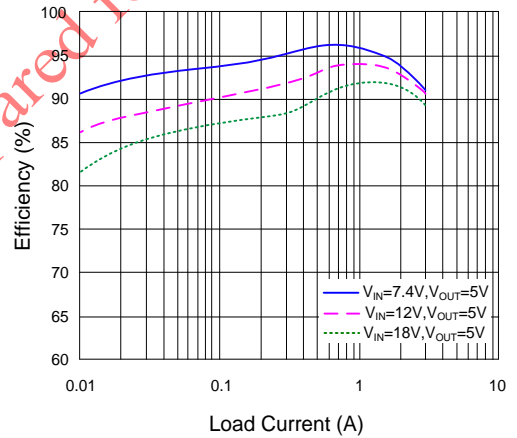

Output Ripple

( $V_{IN}=12V, V_{OUT}=3.3V, I_{LOAD}=0A$ )

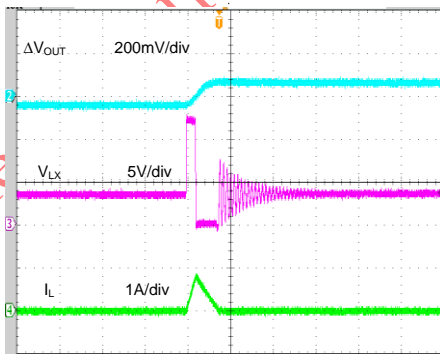

Output Ripple

( $V_{IN}=12V, V_{OUT}=3.3V, I_{LOAD}=3A$ )

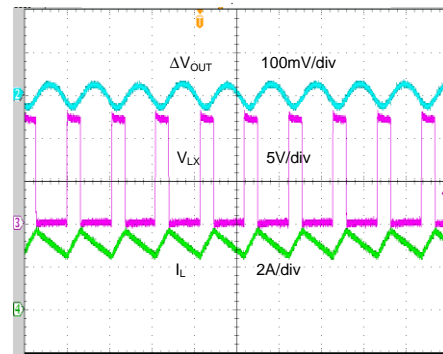

Load Transient

( $V_{IN}=12V$ ,  $V_{OUT}=3.3V$ ,  $I_{LOAD}=0-1.5A$ )

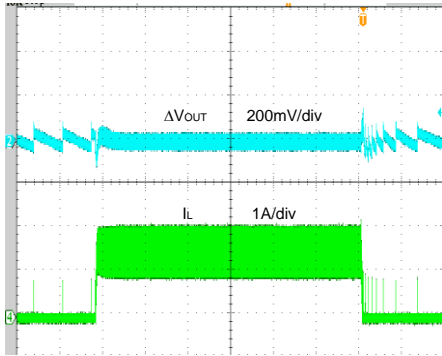

Time (400μs/div)

Load Transient

( $V_{IN}=12V$ ,  $V_{OUT}=3.3V$ ,  $I_{LOAD}=0.3-3A$ )

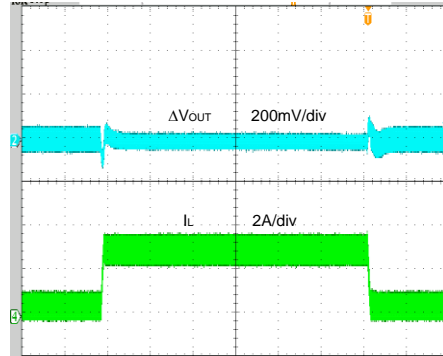

Time (400μs/div)

Startup from Enable

( $V_{IN}=12V$ ,  $V_{OUT}=3.3V$ ,  $I_{LOAD}=3A$ )

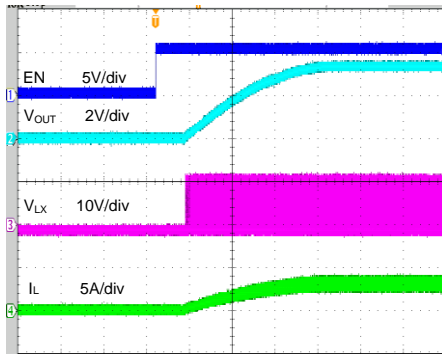

Time (400μs/div)

Shutdown from Enable

( $V_{IN}=12V$ ,  $V_{OUT}=3.3V$ ,  $I_{LOAD}=3A$ )

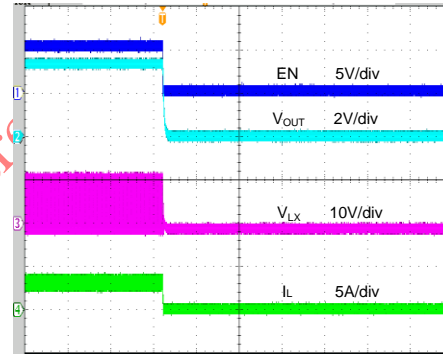

Time (400μs/div)

Startup from  $V_{IN}$

( $V_{IN}=12V$ ,  $V_{OUT}=3.3V$ ,  $I_{LOAD}=3A$ )

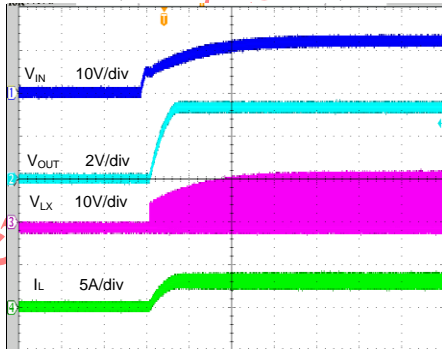

Time (2ms/div)

Shutdown from  $V_{IN}$

( $V_{IN}=12V$ ,  $V_{OUT}=3.3V$ ,  $I_{LOAD}=3A$ )

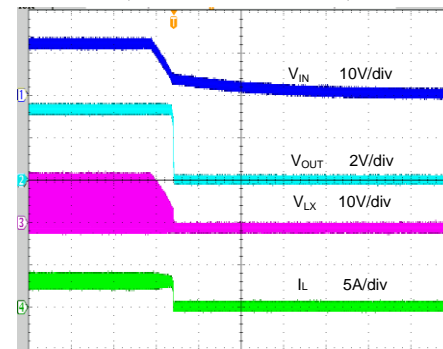

Time (2ms/div)

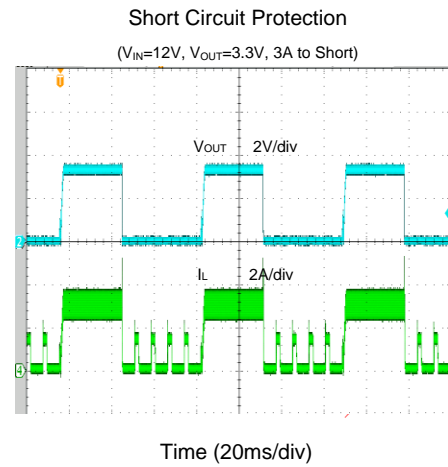
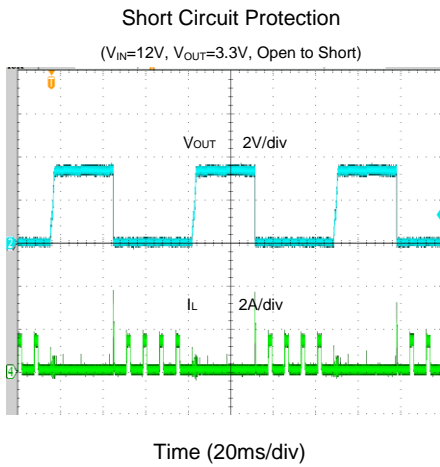

Silergy Corp Confidential Prepared for

## Operation

The SM8103 is a high efficiency, 500kHz synchronous step-down DC/DC regulator capable of delivering up to 3A load current. It can operate over a wide input voltage range from 4.2V to 18V and integrate main switch and synchronous switch with very low  $R_{DS(ON)}$  to minimize the conduction loss. The SM8103 adopts the instant PWM architecture to achieve fast transient responses for high step down applications and high efficiency at light loads.

The SM8103 provides protection functions such as cycle-by-cycle current limit and thermal shutdown protection. The SM8103 will sense the output voltage conditions for the fault protection.

## Applications Information

Because of the high integration in the SM8103, the application circuit based on this IC is rather simple. Only the input capacitor  $C_{IN}$ , the output capacitor  $C_{OUT}$ , the inductor  $L$  and the feedback resistors ( $R_H$  and  $R_L$ ) need to be selected for the targeted applications specifications.

### Feedback Resistor Dividers $R_H$ and $R_L$

Choose  $R_H$  and  $R_L$  to program the proper output voltage. To minimize the power consumption under light loads, it is desirable to choose large resistance values for both  $R_H$  and  $R_L$ . A value of between 10k $\Omega$  and 1M $\Omega$  is highly recommended for both resistors. If  $V_{OUT}$  is 3.3V,  $R_H=100k$  is chosen, then using the following equation,  $R_L$  can be calculated to be 22.1k:

$$R_L = \frac{0.6V}{V_{OUT} - 0.6V} R_H$$

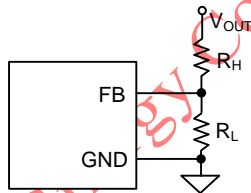

### Input Capacitor $C_{IN}$

The ripple current through the input capacitor is calculated as:

$$I_{CIN\_RMS} = I_{OUT} \cdot \sqrt{D(1-D)}$$

Place a typical X5R or a better grade ceramic capacitor really close to the IN and GND pins to minimize the potential noise problem. Care should be taken to minimize the loop area formed by  $C_{IN}$ , and IN/GND pins. In this case, a 10 $\mu$ F low ESR ceramic capacitor is recommended.

### Output Capacitor $C_{OUT}$

The output capacitor is selected to handle the output ripple noise requirements. Both steady state ripple and transient requirements must be taken into consideration when selecting this capacitor. For the best performance, it is recommended to use X5R or a better grade ceramic capacitor with 16V rating and more than 22 $\mu$ F capacitance.

### Output Inductor $L$

There are several considerations in choosing this inductor.

- 1) Choose the inductance to provide the desired ripple current. It is suggested to choose the ripple current to be about 40% of the maximum output current. The inductance is calculated as:

$$L = \frac{V_{OUT}(1 - V_{OUT}/V_{IN,MAX})}{F_{SW} \times I_{OUT,MAX} \times 40\%}$$

Where  $F_{SW}$  is the switching frequency and  $I_{OUT,MAX}$  is the maximum load current.

The IC is quite tolerant of different ripple current amplitudes. Consequently, the final choice of the inductance can be slightly off the calculation value without significantly impacting the performance.

- 2) The saturation current rating of the inductor must be selected to be greater than the peak inductor current under full load conditions.

$$I_{SAT, MIN} > I_{OUT, MAX} + \frac{V_{OUT}(1 - V_{OUT}/V_{IN,MAX})}{2 \cdot F_{SW} \cdot L}$$

- 3) The DCR of the inductor and the core loss at the switching frequency must be low enough to achieve the desired efficiency requirement. It is desirable to choose an inductor with  $DCR < 50m\Omega$  to achieve good overall efficiency.

### Soft-start

The SM8103 has a built-in soft-start to control the rising rate of the output voltage and limit the input current surge during the IC start-up. The typical soft-start time is 1ms.



### External Bootstrap Capacitor

This capacitor provides the gate driver voltage for the internal high side MOSFET. A 100nF low ESR ceramic capacitor connected between BS pin and LX pin is recommended.

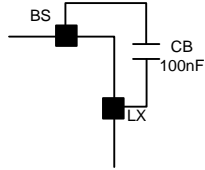

### Load Transient Considerations

The SM8103 integrates the compensation components to achieve good stability and fast transient responses. Adding a small ceramic capacitor in parallel with  $R_H$  will further speed up the load transient responses.

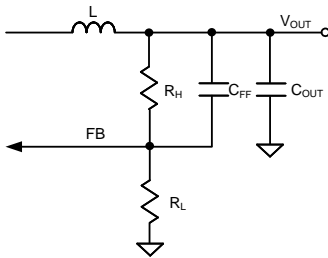

### OCP and SCP Protection Method

If the high side power FET current gets higher than the peak current limit threshold, the high side power FET will turn off and the low side power FET will turn on. If the low side FET current gets higher than the valley current limit threshold, the low side FET will keep turning on until low side FET current decreases below the valley current limit threshold. So both peak and valley current are limited. If the load current continues to increase in these conditions, the output voltage will drop. When the output voltage falls below 33% of the regulation level, the output short will be detected and the IC will operate in hic-cup mode. The hic-cup on time will be 2ms and hic-cup off time is will be 6ms. If the hard short is removed, the IC will return to normal operation.

### Enable and Adjusting Under Voltage Lockout

The EN pin has accurate rising and falling threshold, it provides programmable ON/OFF control by connecting an external resistor divider. Once the EN pin voltage exceeds the rising threshold, the device will start operation. If the EN pin voltage is pulled below the falling threshold, the regulator will stop switching and enter the shutdown state.

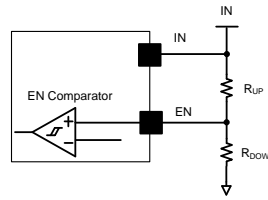

It is not recommended to connect EN and IN directly. A resistor in a range of  $1k\Omega$  to  $1M\Omega$  should be adopted if EN is pulled high by IN.

### Layout Design

The layout design of the SM8103 is relatively simple. For the best efficiency and to minimize the noise problem, we should place the following components close to the IC:  $C_{IN}$ , L,  $R_H$  and  $R_L$ .

- 1) It is desirable to maximize the PCB copper area connecting to the GND pin to achieve the best thermal and noise performance. If the board space allows, a ground plane will be highly desirable.
- 2)  $C_{IN}$  must be close to the IN and GND pins. The loop area formed by  $C_{IN}$  and GND must be minimized.
- 3) The PCB copper area associated with the LX pin must be minimized to avoid the potential noise problem.
- 4) The components  $R_H$  and  $R_L$ , and the trace connected to the FB pin must NOT be adjacent to the LX net on the PCB layout to avoid the noise problem.
- 5) If the system chip interfacing with the EN pin has a high impedance state in the shutdown mode and the IN pin is connected directly to a power source such as a Li-Ion battery, it is desirable to add a pull-down  $1M\Omega$  resistor between the EN and GND pins to prevent the noise from falsely turning on the regulator.

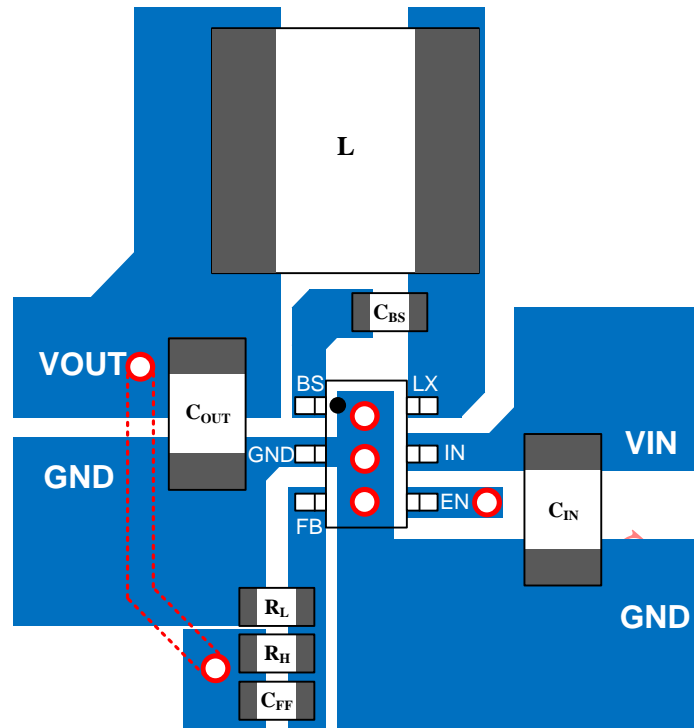
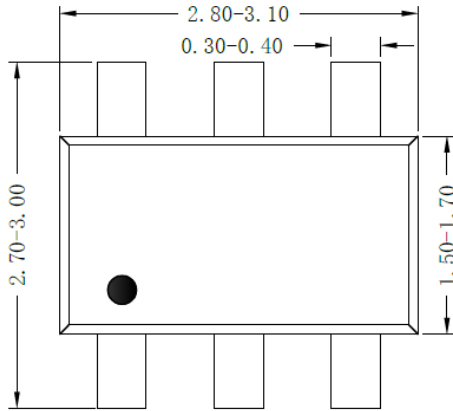
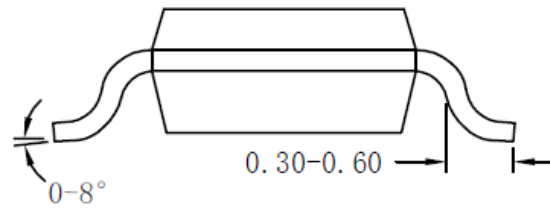

Figure4. PCB Layout Suggestion

**TSOT23-6 Package Outline & PCB Layout**



**Top view**



**Side view**

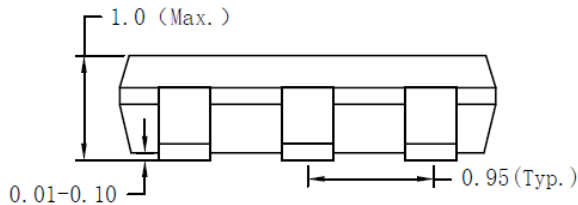

**Front view**

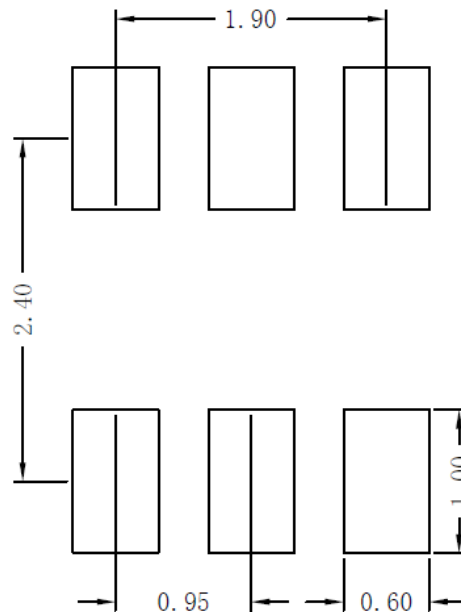

**Recommended Pad Layout**

**Notes: All dimension in millimeter and exclude mold flash & metal burr.**

## Taping & Reel Specification

### 1. Taping orientation

TSOT23-6

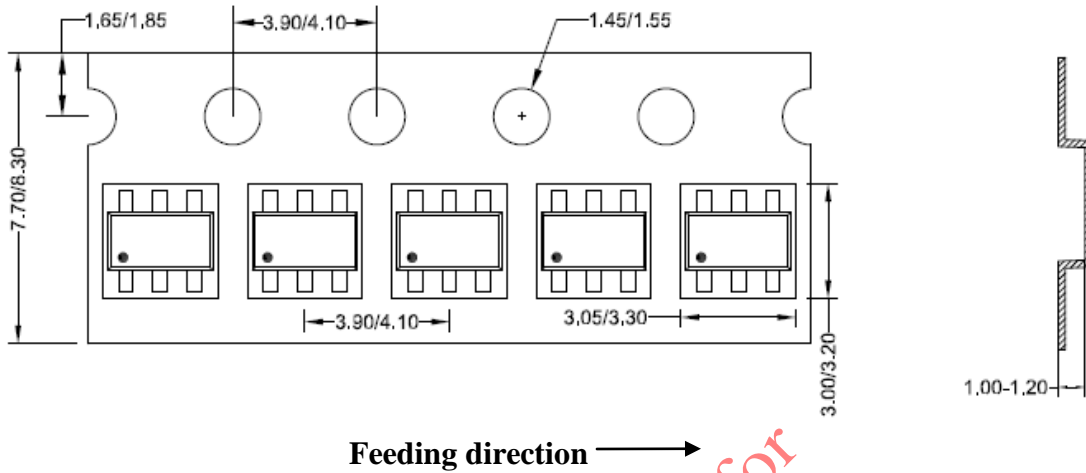

### 2. Carrier Tape & Reel specification for packages

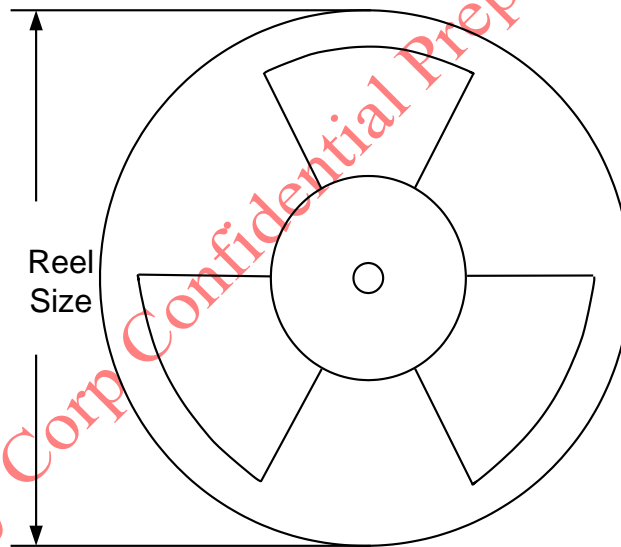

Package types	Tape width (mm)	Pocket pitch(mm)	Reel size (Inch)	Trailer length(mm)	Leader length (mm)	Qty per reel
TSOT23-6	8	4	7"	400	160	3000

### 3. Others: NA.

## X-ON Electronics

Largest Supplier of Electrical and Electronic Components

*Click to view similar products for [Switching Controllers](#) category:*

*Click to view products by [Silergy](#) manufacturer:*

Other Similar products are found below :

[LV5065VB-TLM-H](#) [LV5066V-TLM-H](#) [LV5725JAZ-AH](#) [633888R](#) [MP2908AGF](#) [AZ7500EP-E1](#) [NCP1012AP133G](#) [NCP1217P133G](#)  
[NCP1218AD65R2G](#) [NCP1234AD100R2G](#) [NCP1244BD065R2G](#) [NCP1336ADR2G](#) [NCP1587GDR2G](#) [NCP6153MNTWG](#)  
[NCP81005MNTWG](#) [NCP81101BMNTXG](#) [NCP81205MNTXG](#) [HV9123NG-G-M934](#) [IR35207MTRPBF](#) [ISL6367HIRZ](#) [CAT874-80ULGT3](#)  
[SJ6522AG](#) [SJE6600](#) [TLE63893GV50XUMA1](#) [IR35215MTRPBF](#) [SG3845DM](#) [NCP1216P133G](#) [NCP1236DD65R2G](#) [NCP1247BD100R2G](#)  
[NCP1250BP65G](#) [NCP4202MNR2G](#) [NCP4204MNTXG](#) [NCP6132AMNR2G](#) [NCP81141MNTXG](#) [NCP81142MNTXG](#) [NCP81172MNTXG](#)  
[NCP81203MNTXG](#) [NCP81206MNTXG](#) [NX2155HCUPTR](#) [UC3845ADM](#) [UBA2051C](#) [IR35201MTRPBF](#) [MAX8778ETJ+](#)  
[MAX17500AAUB+T](#) [MAX17411GTM+T](#) [MAX16933ATIR/V+](#) [NCP1010AP130G](#) [NCP1063AD100R2G](#) [NCP1216AP133G](#)  
[NCP1217AP100G](#)