

General Description

The SY20114 high-efficiency 1.5MHz synchronous step-down DC/DC regulator operates over a wide input voltage range of 2.5V to 5.5V and can deliver an output current up to 2A with a low quiescent current of 55 μ A. To minimize conduction loss, it integrates a main switch and a synchronous switch with very low $R_{DS(ON)}$.

The SY20114 is highly integrated, so only the input and output capacitors, inductor, and resistor-divider components need to be selected for the targeted application specifications.

The SY20114 is available in a space-saving, low-profile SOT563 package.

Features

- 2.5V–5.5V Input Voltage Range
- Up to 2A Output Current
- Low $R_{DS(ON)}$ for Internal Switches: 125m Ω Top, 75m Ω Bottom
- Low 55 μ A Quiescent Current
- High 1.5MHz Switching Frequency
Minimizes Required External Components
- Internal Soft-Start Limits Inrush Current
- 100% Dropout Operation
- Power-Good Indicator
- Hiccup Mode for Short-Circuit Protection
- Output Auto-Discharge Function
- RoHS-Compliant and Halogen-Free
- Compact SOT563 Package

Applications

- Set-Top Box
- USB Dongle
- Media Player
- Smartphone

Typical Application

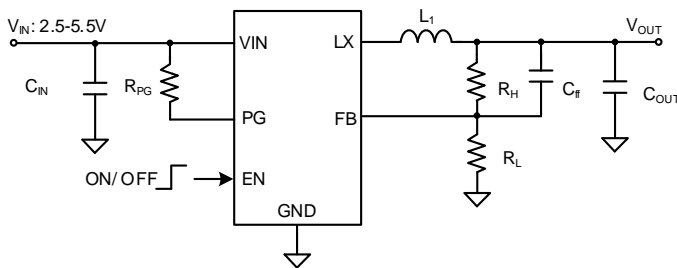

Figure 1. Schematic Diagram

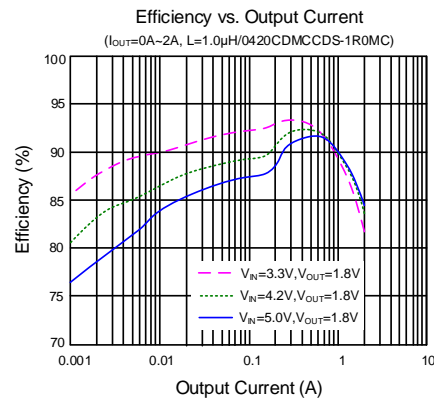
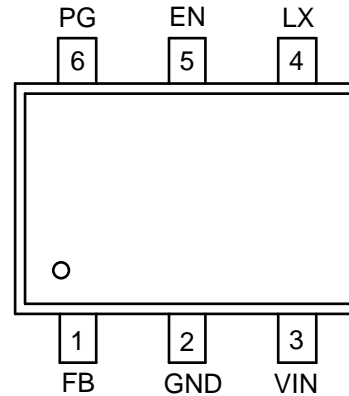

Figure 2. Efficiency vs. Output Current

Ordering Information

Ordering Part Number	Details
SY20114 ARC	PFM Operation Pin 6 Power-Good (PG)
SY20114 BARC	PFM Operation Pin 6 NC (No PG)
SY20114 EARC	Forced PWM Operation Pin 6 Power-Good (PG)
SY20114 FARC	Forced PWM Operation Pin 6 NC (No PG)

Pinout (top view)*



*Pin 6 is NC for SY20114BARC and SY20114FARC

Package Information

Part Number	Top Mark	Package type
SY20114 ARC	M4xyz	SOT-563 RoHS-Compliant, Halogen-Free
SY20114 BARC	M5xyz	
SY20114 EARC	E3xyz	
SY20114 FARC	M6xyz	

x = year code, y = week code, z = lot number code

Pin Description

Pin No	Pin Name	Pin Description
1	FB	Output feedback pin. Connect this pin to the center point of the output resistor divider (as shown in Figure 1) to program the output voltage: $V_{OUT} = 0.6 \times (1 + R_H/R_L)$.
2	GND	Ground pin
3	V _{IN}	Input pin. Decouple this pin from the GND pin with a minimum 10μF ceramic capacitor.
4	LX	Inductor pin. Connect this pin to the switching node of the inductor.
5	EN	Enable control pin. Pull high to turn on. Do not leave floating.
6	PG	SY20114ARC/SY20114EARC: Power-good indicator (open-drain output). The PG pin is high-impedance if the output is between 90% and 120% of the regulation voltage; otherwise, it is driven low. Connect a pullup resistor to the input.
	NC	SY20114BARC/SY20114FARC: NC, leave it floating or connected to GND.

Block Diagram

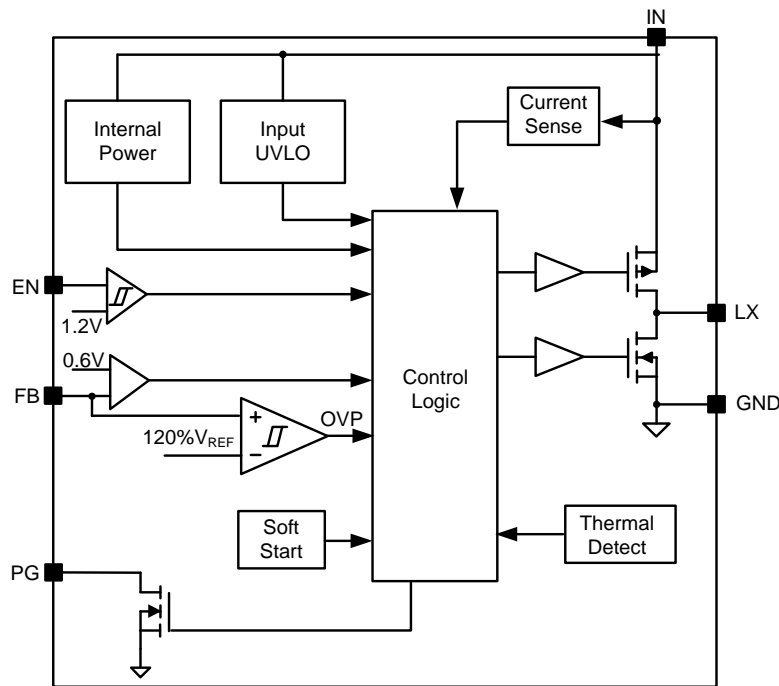

Figure 3. Block Diagram

Absolute Maximum Ratings

Parameter (Note 1)	Min	Max	Unit
IN	-0.3	6	V
EN, FB, PG	-0.3	IN + 0.6	
LX	-0.3	6	
LX, 20ns duration	-3	7	
Junction Temperature, Operating	-40	150	°C
Lead Temperature (Soldering, 10s)		260	
Storage Temperature	-65	150	

Thermal Information

Parameter (Note 2)	Min	Max	Unit
θ_{JA} Junction-to-Ambient Thermal Resistance		90	°C/W
θ_{JC} Junction-to-Case Thermal Resistance		20	
P_D Power Dissipation $T_A = 25^\circ\text{C}$		1.11	W

Recommended Operating Conditions

Parameter (Note 3)	Min	Max	Unit
IN	2.5	5.5	V
Output Voltage	0.6	5.5	
Output Current		2	A
Junction Temperature	-40	125	°C

Electrical Characteristics

($V_{IN} = 5V$, $V_{OUT} = 1.8V$, $L = 1.0\mu H$, $C_{OUT} = 22\mu F$, $T_J = 25^\circ C$, unless otherwise specified)

Parameter	Symbol	Test Conditions	Min	Typ	Max	Unit	
Input	Voltage	V_{IN}	2.5		5.5	V	
	UVLO, rising	$V_{IN,UVLO}$		2.45	2.5	V	
	UVLO, hysteresis	$V_{IN,HYS}$		150		mV	
	Quiescent current	I_Q	$V_{FB} = 105\% \times V_{REF}$ (For SY20114ARC and SY20114BARC Only)		55		μA
	Shutdown current	I_{SHDN}	$V_{EN} = 0V$		0.1	1	μA
FB	Reference voltage	V_{REF}	0.591	0.6	0.609	V	
	Input current	I_{FB}	-50	0	50	nA	
Power Switch	On-resistance	$R_{DS(ON),HS}$		125		m Ω	
	Current limit	$I_{LMT,HS}$	3			A	
Synchronous Rectifier	On-resistance	$R_{DS(ON),LS}$		75		m Ω	
Discharge FET Resistance		R_{DIS}		50		Ω	
Enable (EN)	Input voltage high	$V_{EN,H}$	1.2			V	
	Input voltage low	$V_{EN,L}$			0.4	V	
	Input current	I_{EN}			2	μA	
Soft-Start (SS)	Turn-on delay time	$t_{ON,DLY}$		0.25		ms	
	Soft-start time	t_{SS}		0.75		ms	
Undervoltage Protection	Threshold	V_{UVP}		50		% V_{REF}	
	Delay	$t_{UVP,DLY}$		10		μs	
UVP/OCP Hiccup ON Time		$t_{HICCUP,ON}$		1.45		ms	
UVP/OCP Hiccup OFF Time		$t_{HICCUP,OFF}$		1.45		ms	
Power-Good (SY20114ARC and SY20114EARC only)	Thresholds	V_{PG}	V_{FB} falling, fault		88		%
		V_{PG}	V_{FB} rising, good		90		%
		V_{PG}	V_{FB} rising, fault		120		%
		V_{PG}	V_{FB} falling, good		114		%
	Delay	$t_{PG,R}$	V_{FB} rising, good		2		μs
$t_{PG,F}$		V_{FB} falling, fault		20		μs	
Switching Frequency		f_{SW}		1.5		MHz	
Minimum ON Time		$t_{ON,MIN}$		50		ns	
Maximum Duty Cycle		D_{MAX}	100			%	
Thermal Shutdown Temperature		T_{SD}		160		$^\circ C$	
Thermal Shutdown Hysteresis		T_{HYS}		20		$^\circ C$	

Note 1: Stresses beyond the “Absolute Maximum Ratings” may cause permanent damage to the device. These are stress ratings only. Functional operation of the device at these or any other conditions beyond those indicated in the operational sections of the specification is not implied. Exposure to absolute maximum rating conditions for extended periods may affect device reliability.

Note 2: θ_{JA} of SY20114ARC is measured in the natural convection at $T_A = 25^\circ C$ on a 2OZ two-layer Silergy evaluation board. Pin 4 is the case position for SY20114ARC θ_{JC} measurement.

Note 3: The device is not guaranteed to function outside its operating conditions.

Typical Performance Characteristics

(SY20114ARC, $T_A = 25^\circ\text{C}$, $V_{IN} = 5\text{V}$, $V_{OUT} = 1.8\text{V}$, $L = 1.0\mu\text{H}$, $C_{OUT} = 22\mu\text{F}$, unless otherwise noted)

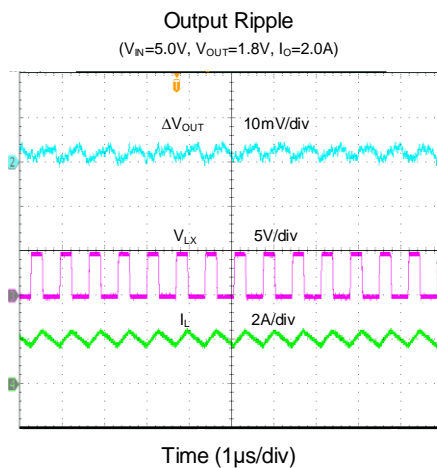
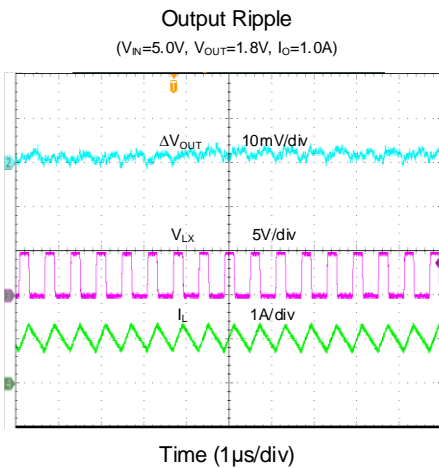
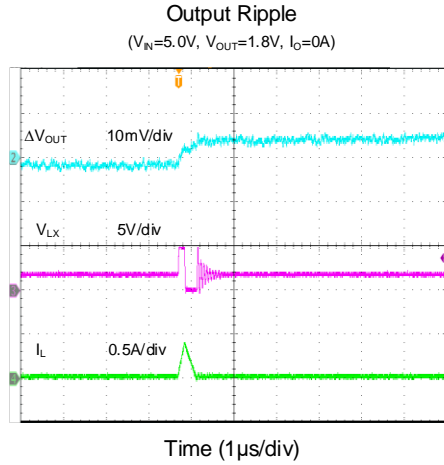
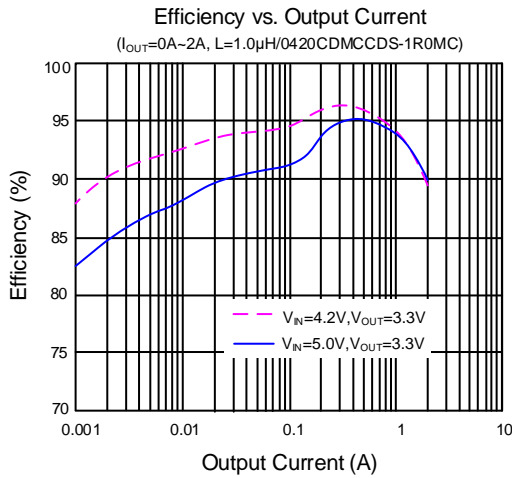
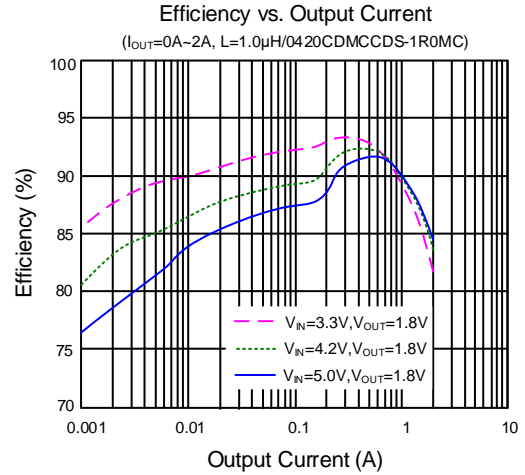
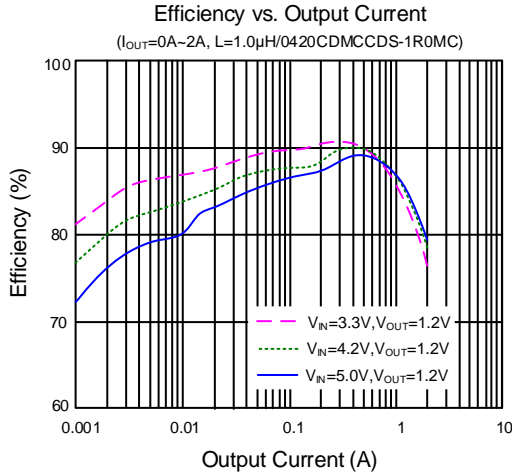

Load Transient
($V_{IN}=5.0V$, $V_{OUT}=1.8V$, $I_O=0A \sim 1A$)

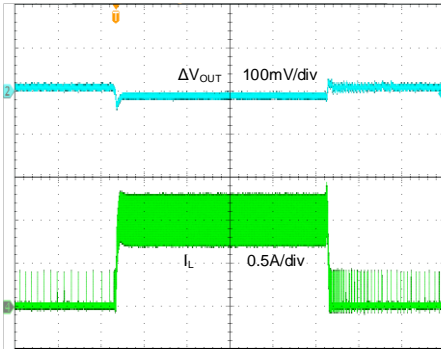

Time (100μs/div)

Load Transient
($V_{IN}=5.0V$, $V_{OUT}=1.8V$, $I_O=0.2A \sim 2A$)

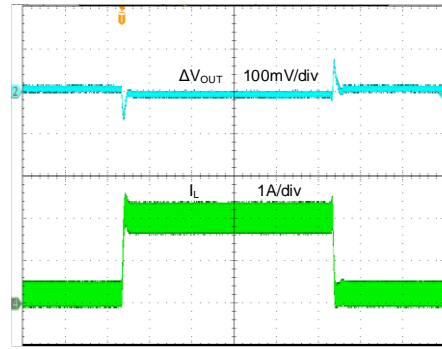

Time (100μs/div)

Startup from V_{IN}
($V_{IN}=5V$, $V_{OUT}=1.8V$, $R_{LOAD}=0.9\Omega$)

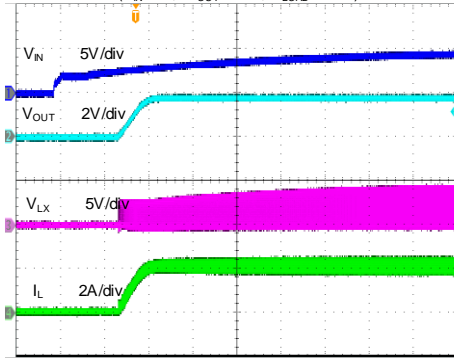

Time (800 μs/div)

Shutdown from V_{IN}
($V_{IN}=5V$, $V_{OUT}=1.8V$, $R_{LOAD}=0.9\Omega$)

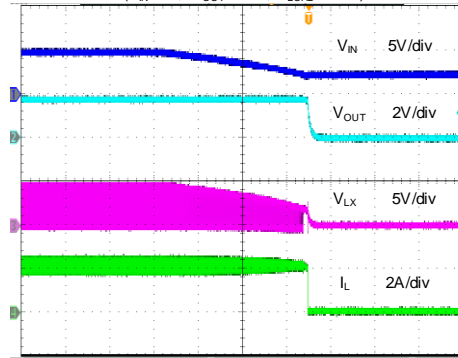

Time (400 μs/div)

Startup from Enable
($V_{IN}=5.0V$, $V_{OUT}=1.8V$, $R_{LOAD}=0.9\Omega$)

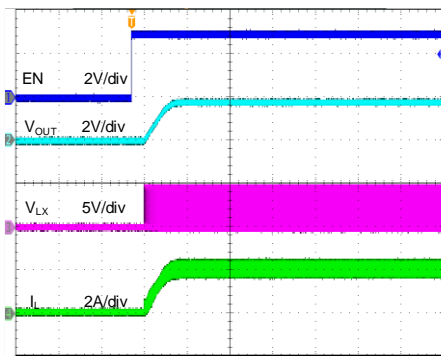

Time (800μs/div)

Shutdown from Enable
($V_{IN}=5.0V$, $V_{OUT}=1.8V$, $R_{LOAD}=0.9\Omega$)

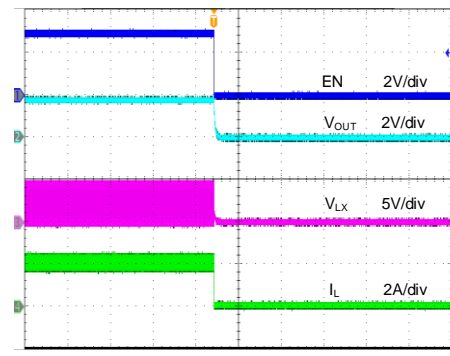

Time (800μs/div)

Short Circuit Protection

($V_{IN}=5.0V$, $V_{OUT}=1.8V$, $I_O=0A$ ~ Short)

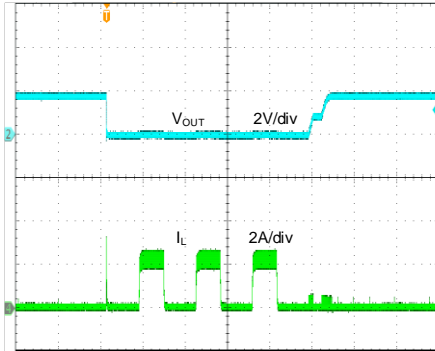

Time (2ms/div)

Short Circuit Protection

($V_{IN}=5.0V$, $V_{OUT}=1.8V$, $I_O=2A$ ~ Short)

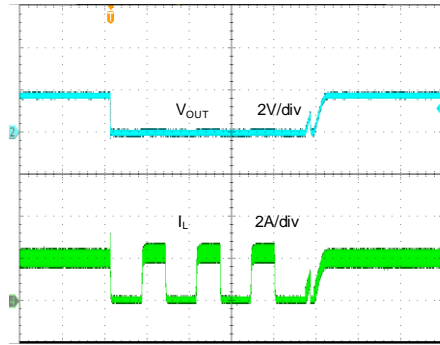

Time (2ms/div)

Bode Plot

($V_{IN}=5V$, $V_{OUT}=1.8V$, $I_{OUT}=2A$)

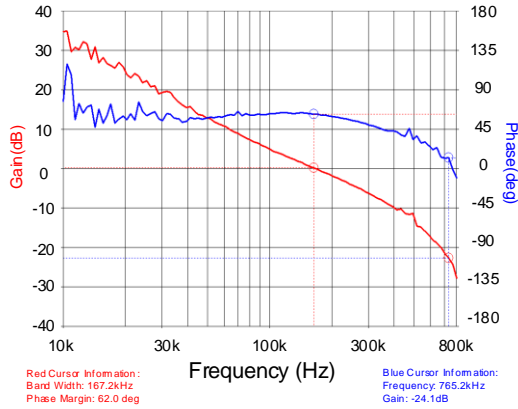

Bode Plot

($V_{IN}=5V$, $V_{OUT}=3.3V$, $I_{OUT}=2A$)

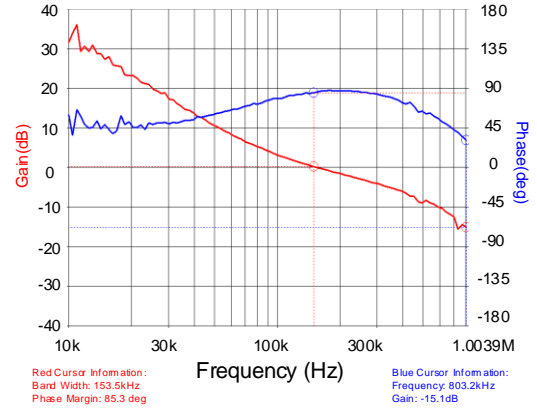

Operation

The SY20114 high-efficiency 1.5MHz synchronous step-down DC/DC regulator operates over a wide input-voltage range of 2.5V to 5.5V and can deliver an output current up to 2A with a low quiescent current of 55 μ A. To minimize conduction loss, it integrates a main switch and a synchronous switch with very low $R_{DS(ON)}$.

The SY20114 employs a constant-off-time and peak-current-mode control strategy. When the top FET's current-sense signal reaches internal V_{COMP} , the top FET turns off and the bottom FET turns on for a fixed period of time (constant t_{OFF}). t_{OFF} is internally calculated according to the input voltage, output voltage, and desired switching frequency (f_{SW}):

$$t_{OFF} = \frac{1 - V_{OUT}/V_{IN}}{f_{SW}}$$

The bottom FET turns off after a period of t_{OFF} .

The SY20114 is available in a space-saving, low-profile SOT563 package.

Application Information

The SY20114 is highly integrated, so only the following components need to be selected for the targeted application specifications: input capacitor C_{IN} , output capacitor C_{OUT} , output inductor L , and feedback resistors R_H and R_L .

Feedback Resistor-Divider R_H and R_L

Choose R_H and R_L to program the proper output voltage. A value between 1k Ω and 1M Ω is recommended for both resistors. If R_L is chosen as 120k Ω , then R_H can be calculated as follows:

$$R_H = \frac{(V_{OUT} - 0.6V) \times R_L}{0.6V}$$

Input Capacitor C_{IN}

For the best performance, select a typical X5R or better grade ceramic capacitor with a 10V rating, and greater than 10 μ F capacitance. The capacitor should be placed as close as possible to the device, while also minimizing the loop area formed by C_{IN} and the IN/GND pins. When selecting an input capacitor, ensure that its voltage rating is at least 20% greater than the maximum voltage of the input supply. X5R or X7R dielectric types are the most often selected due to their small size, low cost, surge current capability, and high RMS current rating over a wide temperature and voltage range.

In situations where the input rail is supplied through long wires, it is recommended to add some bulk capacitance like electrolytic, tantalum or polymer type capacitors to reduce the overshoot and ringing caused by the added parasitic inductance.

Consider the RMS current rating of the input capacitor, paralleling additional capacitors if required to meet the calculated RMS ripple current.

$$I_{CIN_RMS} = I_{OUT} \times \sqrt{D \times (1 - D)}$$

The worst-case condition occurs at $D = 0.5$, then

$$I_{CIN_RMS_MAX} = \frac{I_{OUT}}{2}$$

For simplification, choose an input capacitor with an RMS current rating greater than half of the maximum load current.

The input capacitor value determines the input voltage ripple of the converter. If there is a voltage ripple requirement in the system, choose an appropriate input capacitor that meets the specification.

Given the very low ESR and ESL of ceramic capacitors, the input voltage ripple can be estimated using the formula:

$$V_{CIN_RIPPLE_CAP} = \frac{I_{OUT}}{f_{SW} \times C_{IN}} \times D \times (1 - D)$$

The worst-case condition occurs at $D = 0.5$, then

$$V_{CIN_RIPPLE_CAP_MAX} = \frac{I_{OUT}}{4 \times f_{SW} \times C_{IN}}$$

The capacitance value is less important than the RMS current rating. A single 10 μ F X5R capacitor is sufficient in most applications.

Output Capacitor C_{OUT}

Select the output capacitor C_{OUT} to handle the output ripple requirements. Both steady state ripple and transient requirements must be taken into consideration when selecting the component. For the best performance, use an X5R or better grade ceramic capacitor with a 6.3V rating, and capacitance greater than 22 μ F.

For applications where the design must meet stringent ripple requirements, the following considerations must be followed:

The output voltage ripple at the switching frequency is caused by the inductor current ripple (ΔI_L) on the output capacitor's ESR (ESR ripple), as well as the stored charge (capacitive ripple).

When calculating total ripple, consider both.

$$V_{RIPPLE,ESR} = \Delta I_L \times ESR$$

$$V_{RIPPLE,CAP} = \frac{\Delta I_L}{8 \times C_{OUT} \times f_{SW}}$$

The capacitive ripple might be higher because the effective capacitance for ceramic capacitors decreases with the voltage across the terminals. The voltage derating is usually included as a chart in the capacitor datasheet, and the ripple can be recalculated after taking the target output voltage into account.

Output Inductor L

There are several considerations in choosing this inductor:

- 1) Choose the inductance to provide a ripple current that is approximately 40% of the maximum output current. The recommended inductance is calculated as:

$$L = \frac{V_{OUT}(1 - V_{OUT} / V_{IN,MAX})}{f_{SW} \times I_{OUT,MAX} \times 0.4}$$

where f_{SW} is the switching frequency and $I_{OUT,MAX}$ is the maximum load current.

- 2) The saturation current rating of the inductor must be greater than the peak inductor current under full-load conditions:

$$I_{SAT,MIN} > I_{OUT,MAX} + \frac{V_{OUT}(1 - V_{OUT}/V_{IN,MAX})}{2 \times f_{SW} \times L}$$

- 3) The DCR of the inductor and the core loss at the switching frequency must be low enough to achieve the desired efficiency requirement. It is recommended to choose an inductor with DCR less than 50mΩ to achieve good overall efficiency.

Overcurrent and Short-Circuit Protection

With load current increasing, as soon as the high-side FET current exceeds the peak current-limit threshold, the high-side FET will turn off. If the load current continues to increase, the output voltage will drop. When the output voltage falls below 50% of the regulation level, the output undervoltage protection will be activated and the SY20114 will operate in hiccup mode. The hiccup frequency is 400Hz and the hiccup duty cycle is 50%. If the hard short is removed, the SY20114 will return to normal operation.

Load-Transient Considerations

The SY20114 integrates the compensation components to achieve good stability and fast transient responses. In some applications, adding a ceramic capacitor (feed-forward capacitor C_{ff}) in parallel with R_H may further speed up the load-transient responses, and is therefore recommended for applications with large load-transient step requirements.

Application Schematic ($V_{OUT} = 1.8V$)

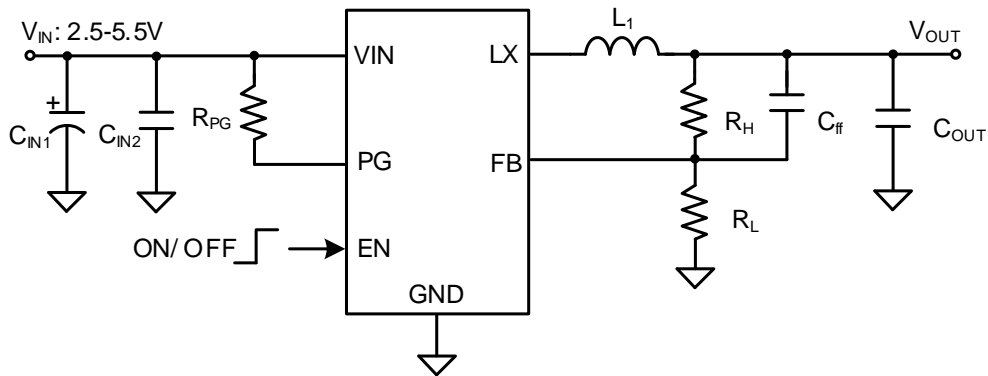

BOM List

Reference Designator	Description	Part Number	Manufacturer
L ₁	1.0μH	0420CDMCCDS-1R0MC	Sumida
C _{IN1}	100μF/25V(electrolytic capacitor)		
C _{IN2}	10μF/10V, 0805, X5R	C2012X5R1A106K	TDK
C _{OUT}	22μF/6.3V, 0805, X5R	C2012X5R0J226M	TDK
C _{ff}	22pF/50V, 0603, C0G	C1608C0G1H220J	TDK
R _H	100kΩ, 1%, 0603		
R _L	49.9kΩ, 1%, 0603		
R _{PG}	100kΩ, 0603		

Recommended Component Values for Typical Applications

V _{OUT} (V)	R _H (kΩ)	R _L (kΩ)	C _{FF} (pF)	L/(Rated/Saturating Current)	C _{OUT}
1.2	49.9	49.9	22	1.0μH/(6.5A/8A)	22μF/6.3V, 0805, X5R
1.8	100	49.9	22	1.0μH/(6.5A/8A)	22μF/6.3V, 0805, X5R
3.3	100	22.1	22	1.0μH/(6.5A/8A)	22μF/6.3V, 0805, X5R

Layout Design

For optimal design, follow these PCB layout considerations:

- For maximum efficiency and minimal noise, the following components should be placed close to the IC: C_{IN} , L, R_H and R_L .
- To achieve the best thermal and noise performance, maximize the PCB copper area connecting to the GND pin. A ground plane is highly recommended if board space allows. Connect the ground pad to a large copper area to enhance thermal performance.
- C_{IN} must be close to pins IN and GND. Minimize the loop area formed by C_{IN} , V_{IN} , and GND.
- To reduce potential noise:
 - Minimize the PCB copper area connected to the LX pin.
 - R_H , R_L , and the trace connecting to the FB pin must **not** be adjacent to the LX net on the PCB layout.

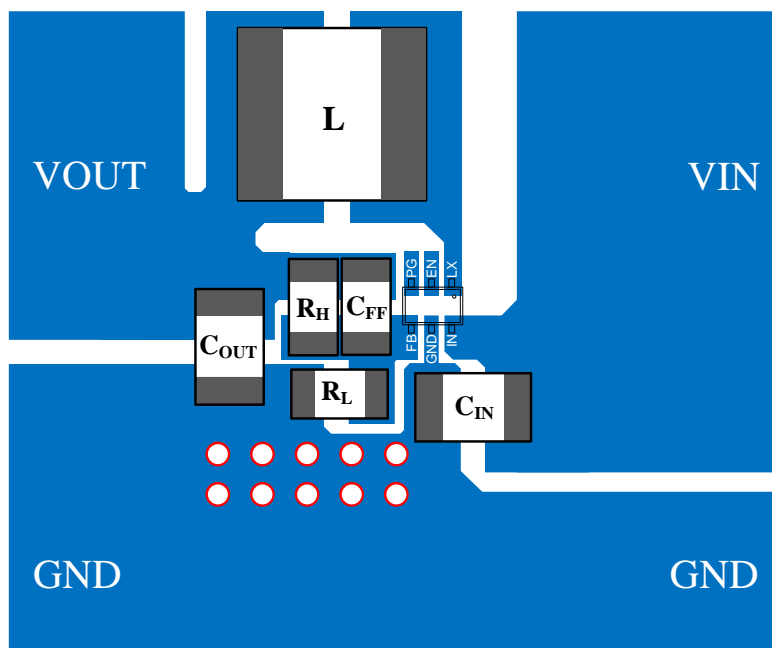
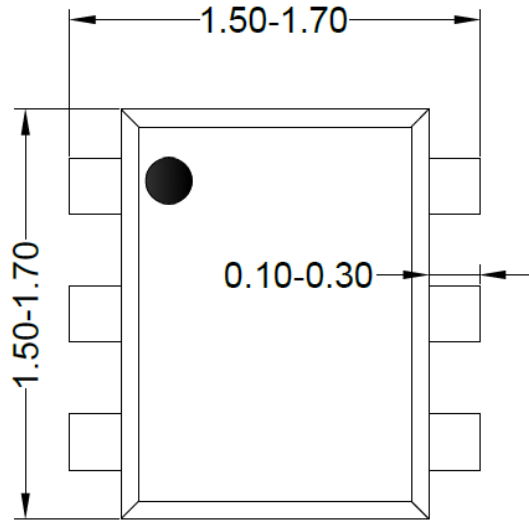
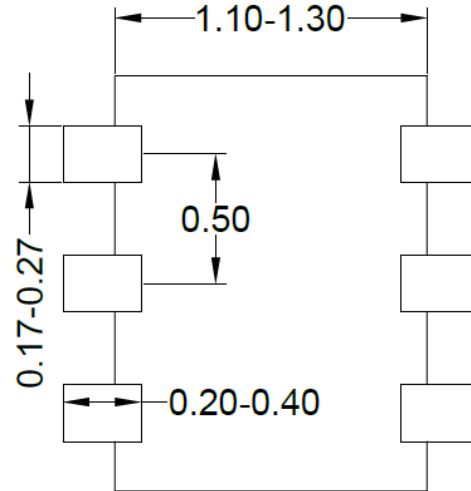

Figure 3. Suggested PCB Layout

SOT563 Package Outline Drawing



Top view



Bottom view

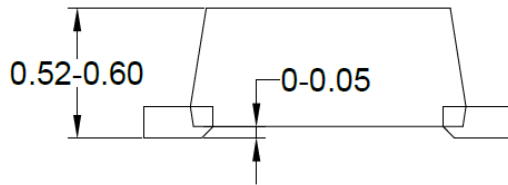

Side View

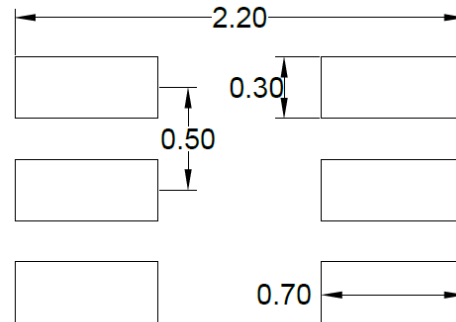

**Recommended PCB layout
(Reference only)**

Note: All dimensions are in millimeters and exclude mold flash and metal burr.

Taping and Reel Specification

Taping Orientation
SOT563

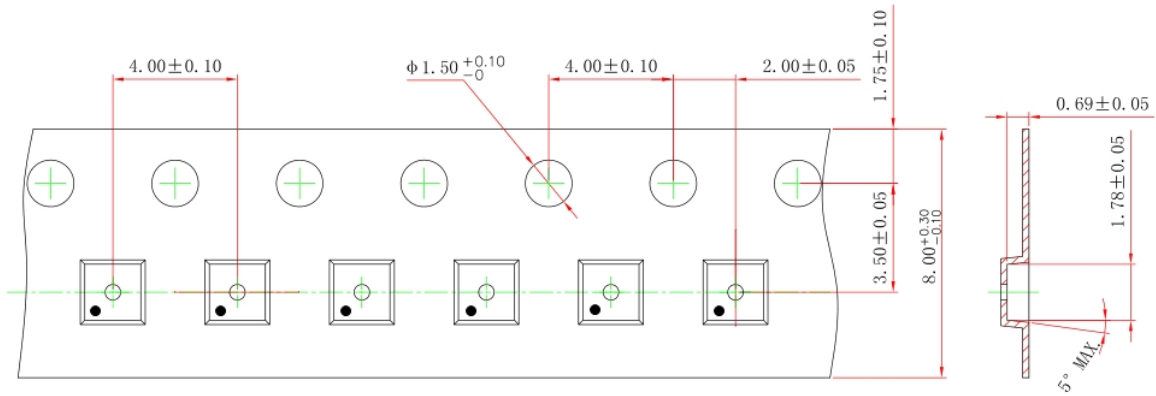

Feeding Direction →

Carrier Tape and Reel Specification for Packages

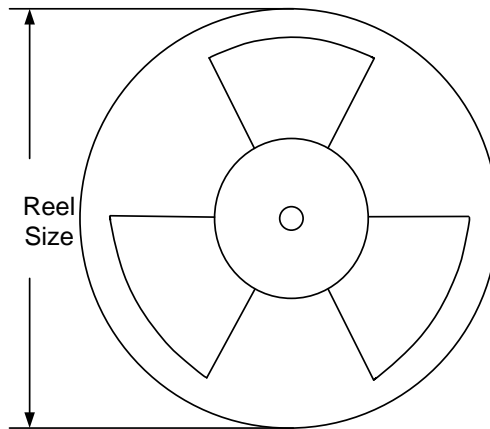

Package types	Tape width (mm)	Pocket pitch(mm)	Reel size (Inch)	Trailer length(mm)	Leader length (mm)	Qty per reel (pcs)
SOT563	8	4	7"	280	160	5000

Others: NA



Revision History

The revision history provided is for informational purposes only and is believed to be accurate; however, it is not warranted. Please make sure that you have the latest revision.

Date	Revision	Change
Jun. 11, 2020	Revision 0.9	Initial Release
Jun. 11, 2021	Revision 1.0	Production Release

IMPORTANT NOTICE

1. **Right to make changes.** Silergy and its subsidiaries (hereafter Silergy) reserve the right to change any information published in this document, including but not limited to circuitry, specification and/or product design, manufacturing or descriptions, at any time and without notice. This document supersedes and replaces all information supplied prior to the publication hereof. Buyers should obtain the latest relevant information before placing orders and should verify that such information is current and complete. All semiconductor products are sold subject to Silergy's standard terms and conditions of sale.

2. **Applications.** Application examples that are described herein for any of these products are for illustrative purposes only. Silergy makes no representation or warranty that such applications will be suitable for the specified use without further testing or modification. Buyers are responsible for the design and operation of their applications and products using Silergy products. Silergy or its subsidiaries assume no liability for any application assistance or designs of customer products. It is customer's sole responsibility to determine whether the Silergy product is suitable and fit for the customer's applications and products planned. To minimize the risks associated with customer's products and applications, customer should provide adequate design and operating safeguards. Customer represents and agrees that it has all the necessary expertise to create and implement safeguards which anticipate dangerous consequences of failures, monitor failures and their consequences, lessen the likelihood of failures that might cause harm and take appropriate remedial actions. Silergy assumes no liability related to any default, damage, costs or problem in the customer's applications or products, or the application or use by customer's third-party buyers. Customer will fully indemnify Silergy, its subsidiaries, and their representatives against any damages arising out of the use of any Silergy components in safety-critical applications. It is also buyers' sole responsibility to warrant and guarantee that any intellectual property rights of a third party are not infringed upon when integrating Silergy products into any application. Silergy assumes no responsibility for any said applications or for any use of any circuitry other than circuitry entirely embodied in a Silergy product.

3. **Limited warranty and liability.** Information furnished by Silergy in this document is believed to be accurate and reliable. However, Silergy makes no representation or warranty, expressed or implied, as to the accuracy or completeness of such information and shall have no liability for the consequences of use of such information. In no event shall Silergy be liable for any indirect, incidental, punitive, special or consequential damages, including but not limited to lost profits, lost savings, business interruption, costs related to the removal or replacement of any products or rework charges, whether or not such damages are based on tort or negligence, warranty, breach of contract or any other legal theory. Notwithstanding any damages that customer might incur for any reason whatsoever, Silergy' aggregate and cumulative liability towards customer for the products described herein shall be limited in accordance with the Standard Terms and Conditions of Sale of Silergy.

4. **Suitability for use.** Customer acknowledges and agrees that it is solely responsible for compliance with all legal, regulatory and safety-related requirements concerning its products, and any use of Silergy components in its applications, notwithstanding any applications-related information or support that may be provided by Silergy. Silergy products are not designed, authorized or warranted to be suitable for use in life support, life-critical or safety-critical systems or equipment, nor in applications where failure or malfunction of an Silergy product can reasonably be expected to result in personal injury, death or severe property or environmental damage. Silergy assumes no liability for inclusion and/or use of Silergy products in such equipment or applications and therefore such inclusion and/or use is at the customer's own risk.

5. **Terms and conditions of commercial sale.** Silergy products are sold subject to the standard terms and conditions of commercial sale, as published at <http://www.silergy.com/stdterms>, unless otherwise agreed in a valid written individual agreement specifically agreed to in writing by an authorized officer of Silergy. In case an individual agreement is concluded only the terms and conditions of the respective agreement shall apply. Silergy hereby expressly objects to and denies the application of any customer's general terms and conditions with regard to the purchase of Silergy products by the customer.

6. **No offer to sell or license.** Nothing in this document may be interpreted or construed as an offer to sell products that is open for acceptance or the grant, conveyance or implication of any license under any copyrights, patents or other industrial or intellectual property rights. Silergy makes no representation or warranty that any license, either express or implied, is granted under any patent right, copyright, mask work right, or other intellectual property right. Information published by Silergy regarding third-party products or services does not constitute a license to use such products or services or a warranty or endorsement thereof. Use of such information may require a license from a third party under the patents or other intellectual property of the third party, or a license from Silergy under the patents or other intellectual property of Silergy.

For more information, please visit: www.silergy.com

©2020 Silergy Corp. All Rights Reserved.

X-ON Electronics

Largest Supplier of Electrical and Electronic Components

Click to view similar products for [Switching Voltage Regulators](#) category:

Click to view products by [Silergy](#) manufacturer:

Other Similar products are found below :

[FAN53610AUC33X](#) [FAN53611AUC123X](#) [EN6310QA](#) [160215](#) [R3](#) [KE177614](#) [FAN53611AUC12X](#) [MAX809TTR](#) [NCV891234MW50R2G](#)
[AST1S31PUR](#) [NCP81203PMNTXG](#) [NCP81208MNTXG](#) [NCP81109GMNTXG](#) [NCP3235MNTXG](#) [NCP81109JMNTXG](#) [MP2161AGJ-Z](#)
[NCP81241MNTXG](#) [NTE7223](#) [NTE7222](#) [NTE7224](#) [L6986FTR](#) [MPQ4481GU-AEC1-P](#) [MP8756GD-P](#) [MPQ2171GJ-P](#) [MPQ2171GJ-AEC1-P](#)
[N JW4153U2-A-TE2](#) [MP2171GJ-P](#) [MP28160GC-Z](#) [MPM3509GQVE-AEC1-P](#) [XDPE132G5CG000XUMA1](#) [LM60440AQRPKRQ1](#)
[MP5461GC-P](#) [NCV896530MWATXG](#) [MPQ4409GQBE-AEC1-P](#) [S-19903DA-A8T1U7](#) [S-19903CA-A6T8U7](#) [S-19903CA-S8T1U7](#) [S-](#)
[19902BA-A6T8U7](#) [S-19902CA-A6T8U7](#) [S-19932BA-A6T8U7](#) [S-19932AA-A6T8U7](#) [S-19932BA-A8T1U7](#) [S-19902AA-A6T8U7](#) [S-](#)
[19903AA-A6T8U7](#) [S-19902AA-S8T1U7](#) [S-19902BA-A8T1U7](#) [AU8310](#) [LMR33630APAQRN XRQ1](#) [LMR33630APCQRN XRQ1](#)
[LMR54406DBVR](#)