

## 0.85V Minimum Input, 5.5V Maximum Output, High-Efficiency 2A Valley-Current Synchronous Boost Converter

### General Description

The SY20492A is a high-efficiency, synchronous Boost converter designed for single-cell lithium (Li-ion or Li-polymer) or two-cell to three-cell nickel (alkaline Ni-Cd or Ni-MH) battery-powered applications. It can operate down to 0.85V input voltage. It uses NMOS for the main switch and PMOS for the synchronous switch.

The SY20492A can disconnect the output from the input during shutdown mode. When the input voltage exceeds the regulated output voltage, the SY20492A will enter bypass mode automatically.

The low operating current along with a 0.1  $\mu\text{A}$  shutdown current (typ.) makes this device suitable for battery applications where extended battery life is important.

The SY20492A is available in a compact SOT23-6 package.

### Features

- 0.85V Minimum Input Voltage
- Adjustable Output Voltage from 1.8V to 5.5V
- Minimum 2A Valley Current Limit
- 5 $\mu\text{A}$  Typical Quiescent Current
- Load Disconnect During Shutdown
- Low  $R_{\text{DS(ON)}}$  at 3.3V Output: 100m $\Omega$  Main, 170m $\Omega$  Synchronous
- Output Overvoltage Protection (OVP)
- Auto-Bypass Mode when  $V_{\text{IN}} \geq V_{\text{OUT}}$
- RoHS-Compliant and Halogen-Free
- Compact Package: SOT23-6

### Applications

- Single-Cell Lithium or Dual-Cell Nickel Battery-Powered Devices (MP3 players, PDAs, etc.)

### Typical Application

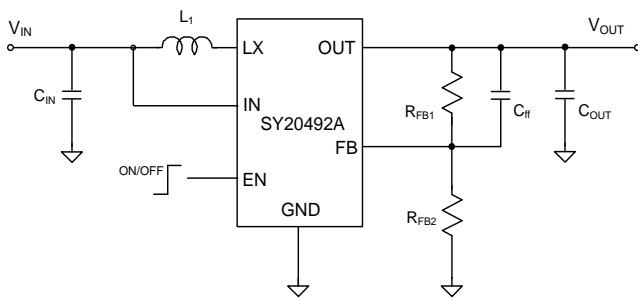

Figure 1. Schematic Diagram

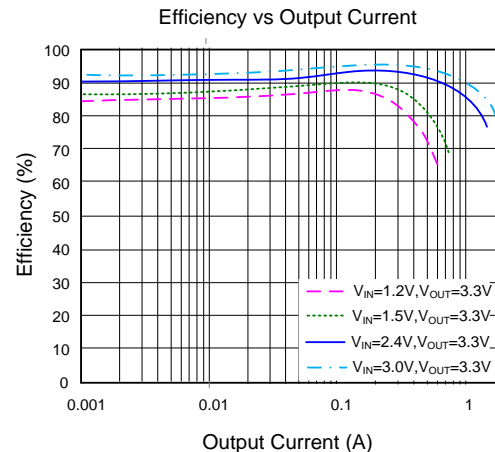

Figure 2. Efficiency vs. Load Current

## Ordering Information

Ordering Part Number	Package Type	Top Mark
SY20492AABC	SOT23-6 RoHS-Compliant and Halogen-Free	<b>cKxyz</b>

*x = year code, y = week code, z = lot number code*

## Pinout (top view)

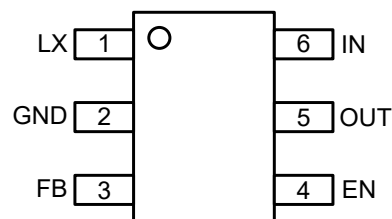

## Pin Description

Pin Number	Pin Name	Pin Description
1	LX	Inductor node. Connect an inductor between the IN pin and the LX pin.
2	GND	Ground pin.
3	FB	Feedback pin. Connect a resistor $R_{FB1}$ between OUT and FB, and a resistor $R_{FB2}$ between FB and GND to program the output voltage. $V_{OUT} = 1.2V \times (R_{FB1} / R_{FB2} + 1)$ .
4	EN	Enable pin. Pull low to disable the device, high to enable. Do not leave this pin floating.
5	OUT	Output pin. Decouple this pin to the GND pin with a minimum of 22 $\mu$ F ceramic capacitor.
6	IN	Input pin.

## Functional Block Diagram

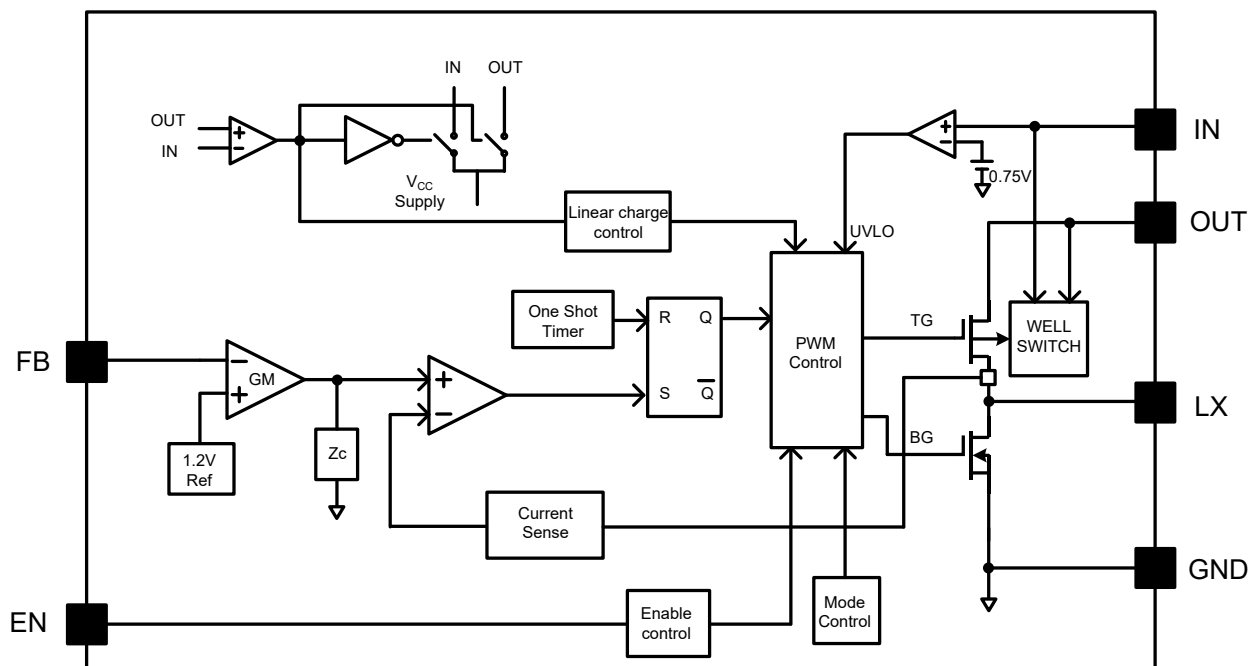



## Absolute Maximum Ratings

Parameter (Note 1)	Min	Max	Unit
FB, IN, OUT, EN	-0.3	6	V
LX	-0.3 <sup>(1)</sup>	6 <sup>(2)</sup>	
Lead Temperature (Soldering, 10s)		260	°C
Junction Temperature, Operating	-40	150	
Storage Temperature	-65	150	

<sup>(1)</sup> LX voltage tested down to -3V < 20ns.

<sup>(2)</sup> LX voltage tested up to +7V < 20ns.

## Thermal Information

Parameter (Note 2)	Typ	Unit
$\theta_{JA}$ Junction-to-Ambient Thermal Resistance	100	°C/W
$\theta_{JC}$ Junction-to-Case Thermal Resistance	30	
$P_D$ Power Dissipation $T_A = 25^\circ\text{C}$	1	W

## Recommended Operating Conditions

Parameter (Note 3)	Min	Max	Unit
IN	0.85	5.5	V
OUT	1.8	5.5	
EN	0	$V_{OUT} + 0.3$	
LX, FB	0	5.5	
Junction Temperature, Operating	-40	125	°C
Ambient Temperature	-40	85	

## Electrical Characteristics

( $V_{IN} = 2.4V$ ,  $V_{OUT} = 3.3V$ ,  $I_{OUT} = 500mA$ ,  $T_A = 25^\circ C$ , unless otherwise specified)

Parameter	Symbol	Test Conditions	Min	Typ	Max	Unit
Input Voltage Range	$V_{IN}$		0.85		5.5	V
Input UVLO Threshold	$V_{UVLO}$			0.7	0.85	V
Input UVLO Hysteresis	$V_{HYS}$			0.04		V
Quiescent Current	$V_{IN}$	$V_{FB} = 1.3V$ , $V_{EN} = V_{IN} = 1V$ , $V_{OUT} = 3.4V$		0.7		$\mu A$
	$V_{OUT}$			5		$\mu A$
Shutdown Current	$I_{SHDN}$	$V_{EN} = 0V$ , $V_{IN} = 2.4V$		0.1	1	$\mu A$
Linear Charge Current	$I_{CHARGE}$	$V_{OUT} < 0.5V_{IN}$		1		A
Feedback Reference Voltage	$V_{REF}$		1.182	1.2	1.218	V
Low-Side Main FET $R_{ON}$	$R_{DS(ON)1}$			100		m $\Omega$
Synchronous FET $R_{ON}$	$R_{DS(ON)2}$			170		m $\Omega$
EN Input Voltage High	$V_{EN,H}$	$V_{IN} \leq 1.6V$ and $V_{OUT} \leq 1.6V$	0.7			V
		$V_{IN} > 1.6V$ or $V_{OUT} > 1.6V$	1.2			V
EN Input Voltage Low	$V_{EN,L}$	$V_{IN} \leq 1.6V$ and $V_{OUT} \leq 1.6V$			0.25	V
		$V_{IN} > 1.6V$ or $V_{OUT} > 1.6V$			0.4	V
EN Leakage Current	$I_{EN,LK}$	$V_{EN} = 3.3V$	-1		1	$\mu A$
Min On-Time	$t_{ON,MIN}$			60		ns
Min Off-Time	$t_{OFF,MIN}$			140		ns
Soft-Start Time	$t_{SS}$			1		ms
Switching Frequency	$F_{SW}$	$V_{OUT} = 3.3V$ , CCM		1		MHz
Valley FET Current Limit	$I_{LMT,VAL}$		2			A
Output Overvoltage Threshold	$V_{OVP}$			5.8		V
Output Overvoltage Hysteresis	$V_{OVP,HYS}$			0.3		V
Thermal Shutdown Temperature	$T_{SD}$			150		$^\circ C$
Thermal Shutdown Hysteresis	$T_{HYS}$			20		$^\circ C$

**Note 1:** Stresses beyond “Absolute Maximum Ratings” may cause permanent damage to the device. These are for stress ratings. Functional operation of the device at these or any other conditions beyond those indicated in the operational sections of the specifications is not implied. Exposure to absolute maximum rating conditions for extended periods may affect device reliability.

**Note 2:** Package thermal resistance is measured in the natural convection at  $T_A = 25^\circ C$  on a two-layer Silergy Evaluation Board.

**Note 3:** The device is not guaranteed to function outside its operating conditions.

## Typical Performance Characteristics

( $T_A = 25^\circ\text{C}$ ,  $V_{IN} = 1.5\text{V}$ ,  $V_{OUT} = 3.3\text{V}$ ,  $L = 1\mu\text{H}$ ,  $C_{OUT} = 22\mu\text{F}$ , unless otherwise specified.)

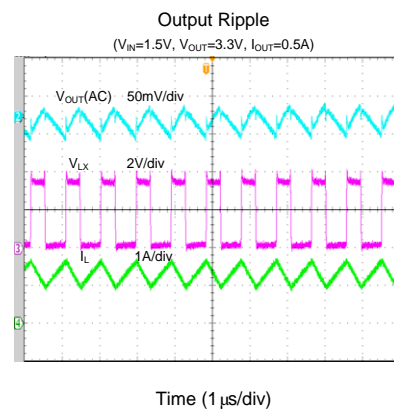
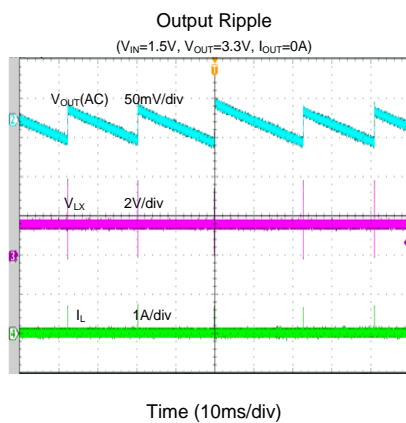
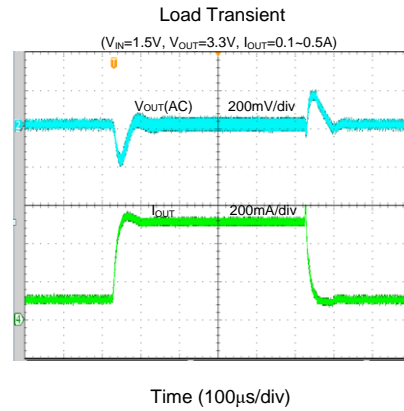
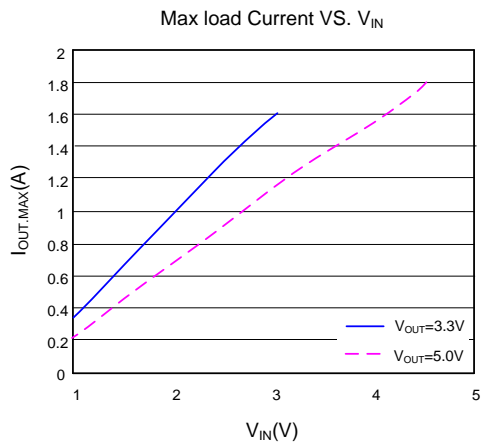
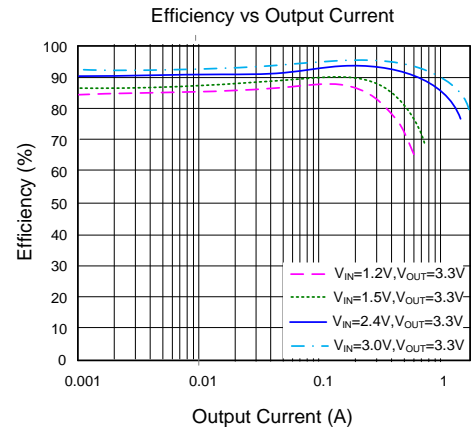
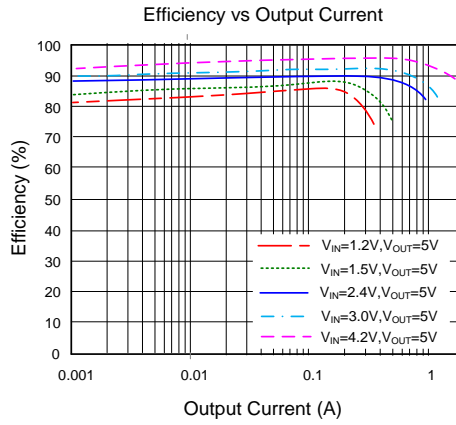

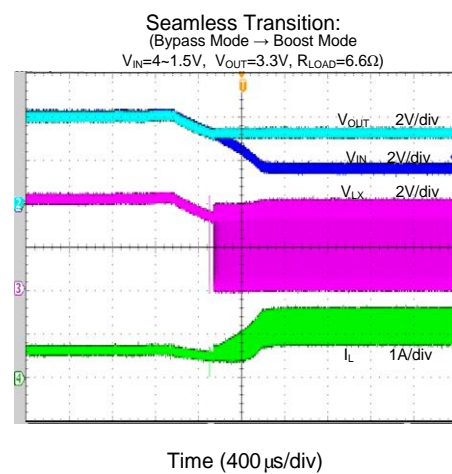
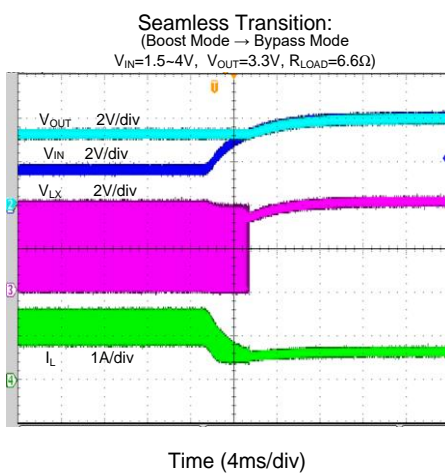
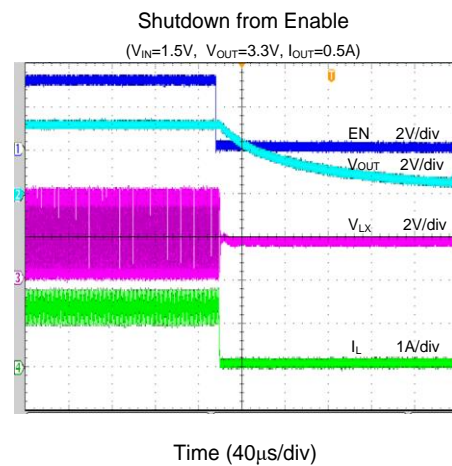
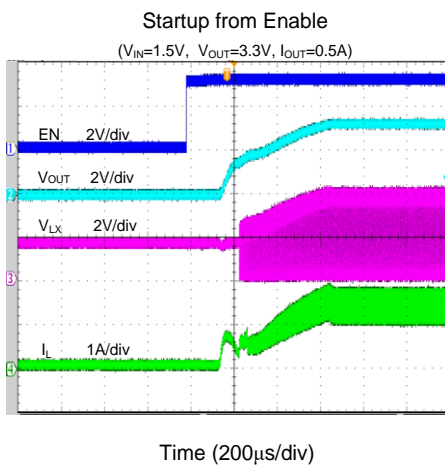
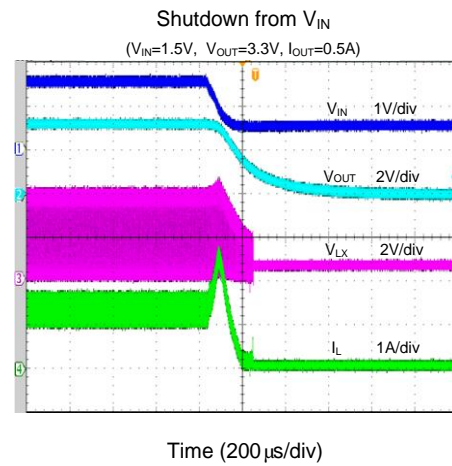
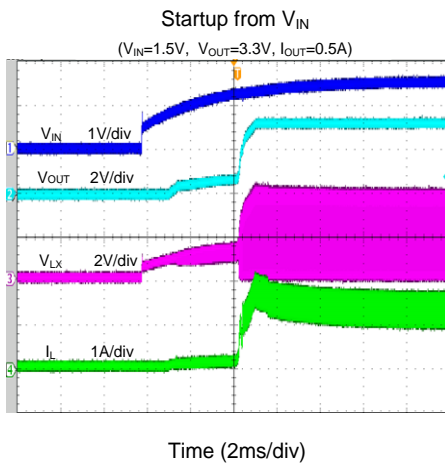

Short Circuit Protection  
( $V_{IN}=1.5V$ ,  $V_{OUT}=3.3V$ ,  $I_O=0A$ -Short)

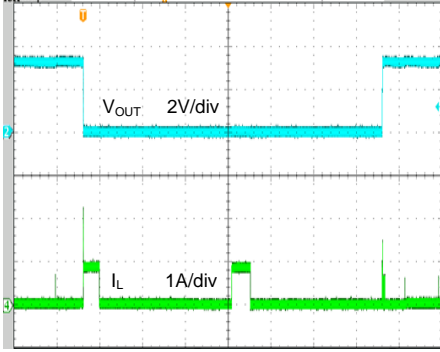

Time (20ms/div)

Short Circuit Protection  
( $V_{IN}=1.5V$ ,  $V_{OUT}=3.3V$ ,  $I_O=0.5A$ -Short)

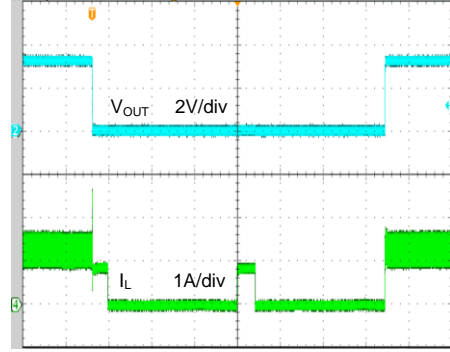

Time (20ms/div)

## Application Information

### Operation

The SY20492A operates using constant-on-time valley-current control. The one-shot circuit or on-time generator, which determines how long to turn on the high-side power switch, is fundamental to any constant-on-time (COT) architecture. Each on-time ( $t_{ON}$ ) is a fixed period internally calculated to operate the step-down regulator at the desired switching frequency over the input and output voltage range, where  $t_{ON} = T_{SW} * (V_O - V_{IN})/V_O$ .

The low-side FET is turned on at the start of every switching cycle, and inductor current ramps up. After turning on for the period  $t_{ON}$ , the low-side FET closes and the high-side FET opens. During this period, inductor current decays until it is lower than the valley-current threshold  $V_{COMP}$ . An internal signal then sets and the low-side FET starts turning on in a new switching cycle. See Figure 3 for details.

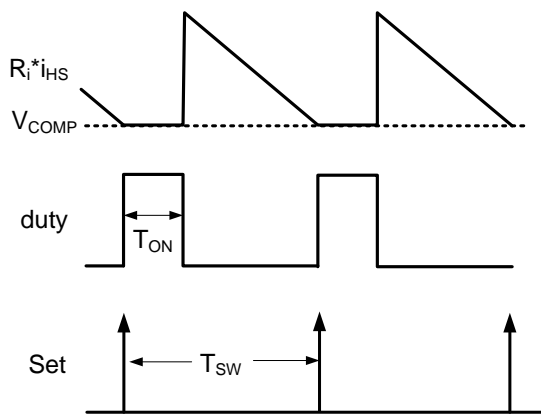

Figure 3. Constant-On-Time Valley-Current Control

The following paragraphs describe the selection process for the input capacitor  $C_{IN}$ , the output capacitor  $C_{OUT}$ , the inductor  $L$ , and the feedback resistor-divider ( $R_1$  and  $R_2$ ).

### Feedback Resistor-Divider $R_1$ and $R_2$ :

Choose  $R_1$  and  $R_2$  in the feedback resistor-divider to configure the output voltage. A value between 100k $\Omega$  and 1M $\Omega$  is recommended for both resistors to minimize power consumption under light loads. If  $V_{OUT} = 3.3V$  and

$R_1$  is chosen to be 510k $\Omega$ , then  $R_2$  can be calculated as 300k $\Omega$  using the following formula:

$$R_2 = \frac{1.2V}{V_{OUT} - 1.2V} R_1$$

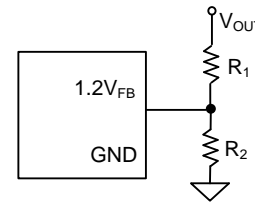

Figure 4. Feedback Resistor-Divider

### Input Capacitor $C_{IN}$

Input filter capacitors reduce the ripple voltage on the input, filter the switched current drawn from the input supply, and reduce potential EMI. When selecting an input capacitor, be sure to select a voltage rating at least 20% greater than the maximum voltage of the input supply and a temperature rating higher than the system requirements. X5R or X7R series ceramic capacitors are most often selected due to their small size, low cost, surge-current capability, and high RMS current ratings over a wide temperature and voltage range. However, systems that are powered by a wall adapter or other long and therefore inductive cabling may be susceptible to significant inductive ringing at the input to the device. In these cases, consider adding some bulk capacitance like electrolytic, tantalum, or polymer type capacitors. Using a combination of bulk capacitors (to reduce overshoot or ringing) in parallel with ceramic capacitors (to meet the RMS current requirements) is helpful in these cases.

Consider the RMS current rating of the input capacitor, paralleling additional capacitors if required to meet the calculated RMS ripple current.

The ripple current through input capacitor is calculated as:

$$I_{CIN\_RMS} = \frac{V_{IN} \times (V_{OUT} - V_{IN})}{2\sqrt{3} \times L f_{SW} \times V_{OUT}}$$

For the best performance, select a typical X5R or better grade ceramic capacitor. The component should be placed as close as possible to the IN and GND pins, while also minimizing the loop area formed by  $C_{IN}$  and the IN/GND pins. In this case, a 22 $\mu F$  low-ESR ceramic capacitor is recommended to improve transient behavior



of the regulator and EMI behavior of the total power-supply circuit.

### Output Capacitor $C_{OUT}$

Select the output capacitor  $C_{OUT}$  to handle the output ripple requirements. Both steady-state ripple and transient requirements must be taken into consideration when selecting  $C_{OUT}$ . For the best performance, use a X5R or better grade ceramic capacitor with a 6.3V rating and at least 22 $\mu$ F capacitance.

For applications where the design must meet stringent ripple requirements, the following considerations must be followed:

The output-voltage ripple at the switching frequency is caused by the inductor-current ripple ( $\Delta I_L$ ) on the output capacitor's ESR (ESR ripple), as well as the stored charge (capacitive ripple). When calculating total ripple, both should be considered.

$$V_{\text{RIPPLE, ESR1}} = I_{\text{LPEAK}} \times \text{ESR}$$

$$V_{\text{RIPPLE, ESR2}} = I_{\text{LVALLEY}} \times \text{ESR}$$

$$V_{\text{RIPPLE,CAP}} = \frac{I_{\text{OUT}} \times (1-D)}{C_{\text{OUT}} \times f_{\text{SW}}}$$

The capacitive ripple might be higher because the effective capacitance for ceramic capacitors decreases with the voltage across the terminals. The voltage derating is usually included as a chart in the capacitor datasheet, and the ripple can be recalculated after taking the target output voltage into account.

### Li-Ion Battery Hot Plug Consideration

In the mass production stage, the Li-Ion battery will always hot plug between the IN and GND pins. The hot plug may lead to large voltage spikes, or even to IC EOS failure. To avoid this potential risk, place one 22 $\mu$ F ceramic capacitor in series with a 0.1 $\Omega$  resistor to absorb the input voltage spike. With this solution, the voltage spike can be reduced from 6.12V to 5.2V. See Figure 5 and Figure 6 for more details.

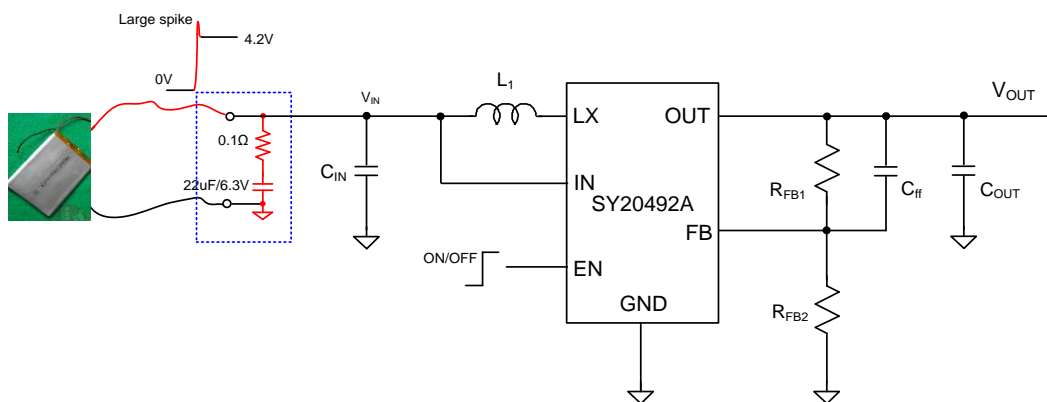

Figure 5. Voltage Spike Suppression

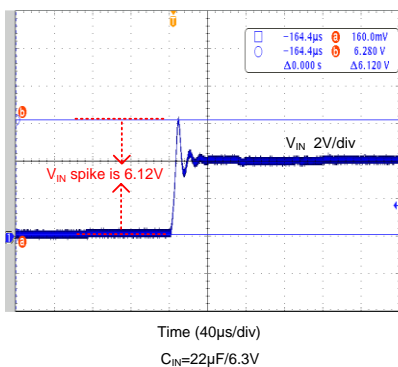

Figure 6. Voltage Spike without Suppression

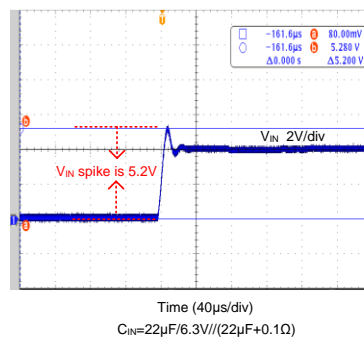

Figure 7. Voltage Spike with Suppression

## Boost Inductor L

Consider the following when choosing this inductor:

- Choose the inductance to provide a ripple current that is approximately 40% of the maximum output current. The recommended inductance is calculated as:

$$L = \left( \frac{V_{IN}}{V_{OUT}} \right)^2 \frac{(V_{OUT} - V_{IN})}{f_{SW} \times I_{OUT\_MAX} \times 40\%}$$

where  $f_{SW}$  is the switching frequency and  $I_{OUT\_MAX}$  is the maximum load current.

The SY20492A has high tolerance for ripple-current amplitude variation. As a result, the final choice of inductance can vary slightly from the calculated value with no significant performance impact.

- The saturation-current rating of the inductor must be selected to be greater than the peak inductor current under full-load conditions.

$$I_{SAT\_MIN} > \left( \frac{V_{OUT}}{V_{IN} \times \eta} \right) \times I_{OUT\_MAX} + \frac{V_{IN}(V_{OUT} - V_{IN})}{2 \times f_{SW} \times L \times V_{OUT}}$$

- The DCR of the inductor and the core loss at the switching frequency must be low enough to achieve the desired efficiency requirement. Choose an inductor with DCR greater than 50mΩ to achieve good overall efficiency.

## EN Input

Driving the EN pin high (>1.2V) enables normal operation. Driving the EN pin low (<0.4V) will shut down the device. During shutdown mode, the SY20492A shutdown current drops to less than 1µA.

## Overcurrent Protection

The SY20492A provides cycle-by-cycle overcurrent protection and turns off the main power MOSFET once the inductor current reaches the overcurrent-limit threshold. During overcurrent protection, the output voltage drops as a function of the load. As soon as the overload condition is removed, the converter resumes operation.

## Thermal Protection

The SY20492A includes overtemperature protection circuitry to prevent overheating due to excessive power dissipation. This will shut down the device when the junction temperature exceeds 150°C. When the junction temperature cools down by approximately 20°C, the device will resume normal operation after a complete soft-start cycle. For continuous operation, provide adequate cooling so that the junction temperature does not exceed the thermal protection threshold.

## Typical Application Schematic

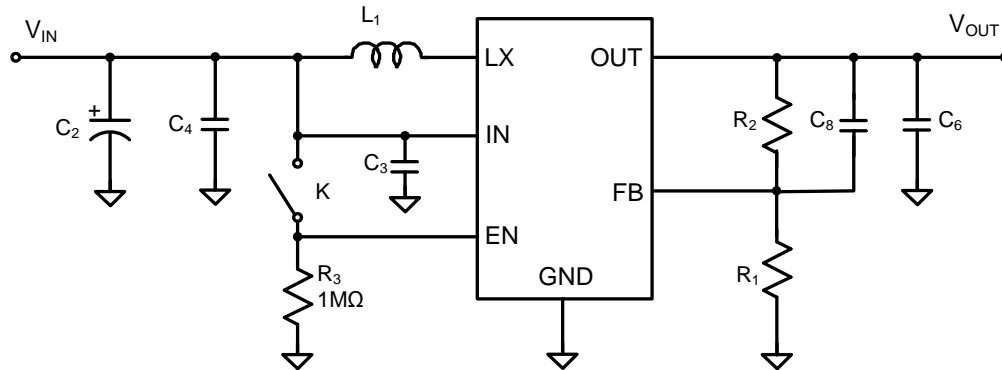

## Design Specifications

Input Voltage (V)	Output Voltage (V)	Output Current Limit (A)
0.85-3.3	3.3	0.3

## BOM List

Reference Designator	Description	Part Number	Manufacturer
C2	100µF/25V, Electrolytic Capacitor		
C3, C4	10µF/6.3V,0603	C1608X5R0J106M	TDK
C6	22µF/6.3V,0805	C2012X5R0J226M	TDK
C8	22pF/50V,0603	C1608C0G1H220J	TDK
L1	1µH/8.6A	VLP6045LT-1R0N	TDK
R1	300kΩ		
R2	510kΩ		
R3	1MΩ		

## Recommended Components for Typical Applications

V <sub>OUT</sub> (V)	R2(kΩ)	R1(kΩ)	L(µH)	C <sub>OUT</sub>
5	300	951	1	22µF/10V/X5R,1206
3.3	300	510	1	22µF/6.3V/X5R,1206

## Recommended PCB Layout

Follow these PCB layout guidelines for optimal performance and thermal dissipation:

- Place the following components as close as possible to the IC: C<sub>IN</sub>, L, R1, and R2.
- To achieve the best thermal and noise performance, maximize the PCB copper area connecting to the GND pin. If board space allows, using a large copper pour connected to GND ground plane is recommended.
- C<sub>IN</sub> must be close to the IN and GND pins. Minimize the loop area formed by C<sub>IN</sub> and GND.
- Minimize the PCB copper area associated with the LX pin to reduce EMI emissions.
- To avoid crosstalk, R1, R2, and the trace connecting to the FB pin must not be adjacent to the LX net on the PCB layout.
- If the system chip controlling the EN pin has a high-impedance state during low-power modes and the IN pin is connected directly to a power source such as a Li-Ion battery, add a 1MΩ pull-down resistor between the EN and GND pins to prevent potential noise from falsely triggering the regulator during shutdown mode.

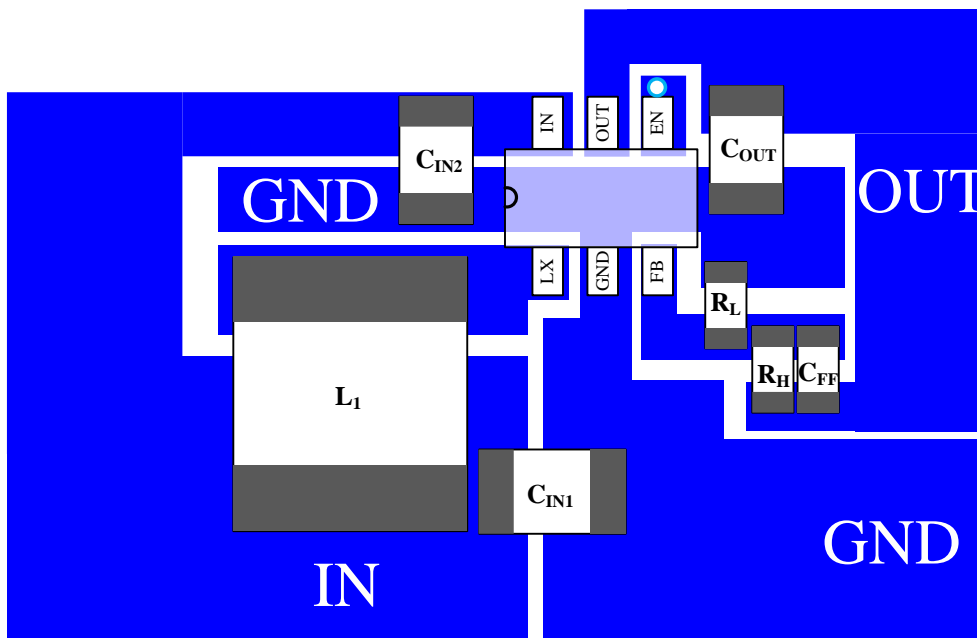
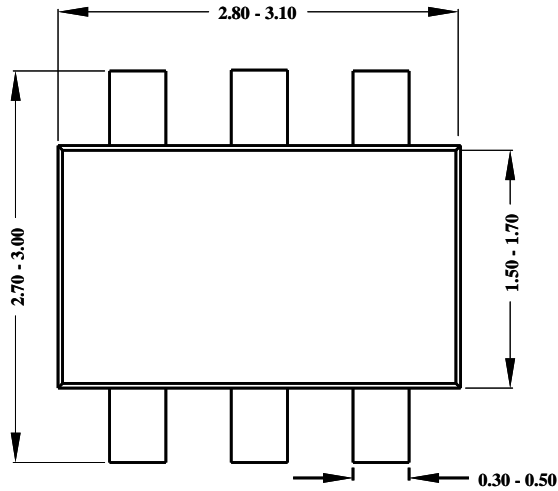
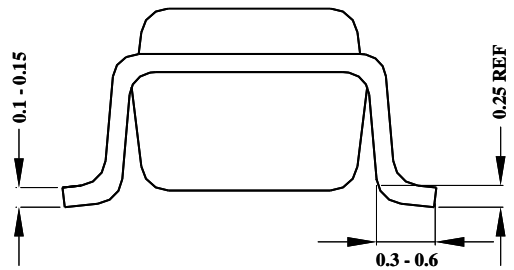

Figure 8. Suggested PCB Layout

**SOT23-6 Package Outline Drawing**



**Top view**



**Side view A**

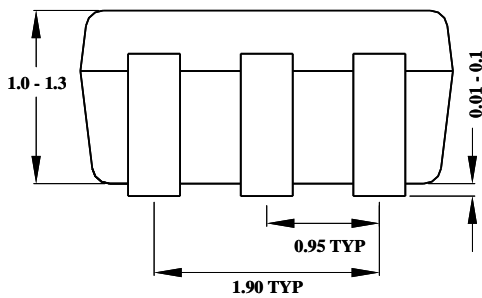

**Side view B**

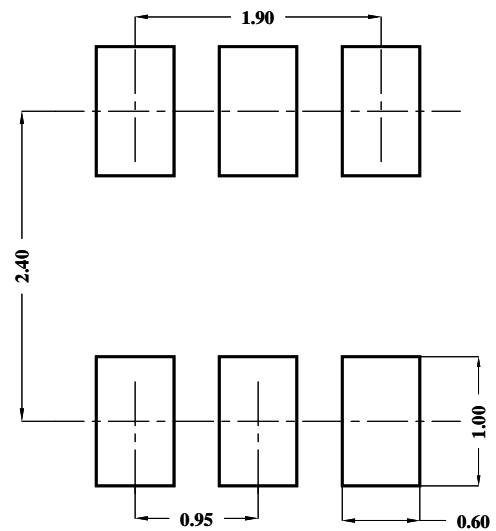

**Recommended pad layout (reference only)**

**Note:** All dimensions are in millimeters and exclude mold flash and metal burr.

**Taping and Reel Specification**

**SOT23-6 taping orientation**

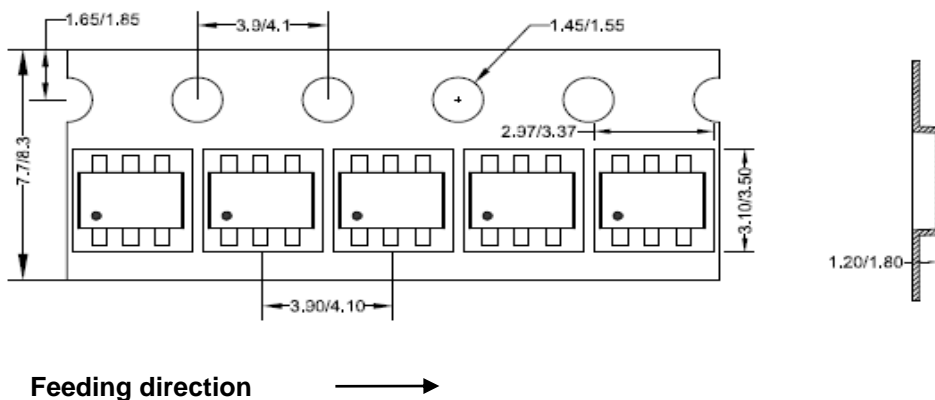

**Carrier tape and reel specification for packages**

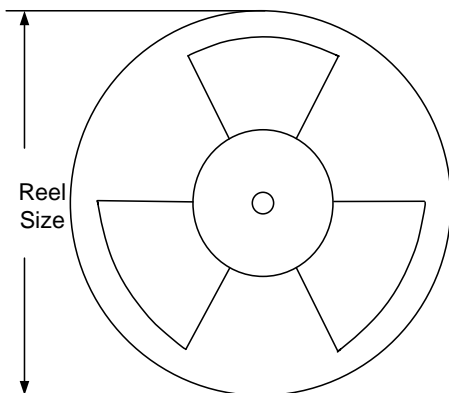

Package type	Tape width (mm)	Pocket pitch(mm)	Reel size (Inch)	Trailer length(mm)	Leader length (mm)	Qty per reel (pcs)
SOT23-6	8	4	7"	280	160	3000

Others: NA



## IMPORTANT NOTICE

1. **Right to make changes.** Silergy and its subsidiaries (hereafter Silergy) reserve the right to change any information published in this document, including but not limited to circuitry, specification and/or product design, manufacturing or descriptions, at any time and without notice. This document supersedes and replaces all information supplied prior to the publication hereof. Buyers should obtain the latest relevant information before placing orders and should verify that such information is current and complete. All semiconductor products are sold subject to Silergy's standard terms and conditions of sale.

2. **Applications.** Application examples that are described herein for any of these products are for illustrative purposes only. Silergy makes no representation or warranty that such applications will be suitable for the specified use without further testing or modification. Buyers are responsible for the design and operation of their applications and products using Silergy products. Silergy or its subsidiaries assume no liability for any application assistance or designs of customer products. It is customer's sole responsibility to determine whether the Silergy product is suitable and fit for the customer's applications and products planned. To minimize the risks associated with customer's products and applications, customer should provide adequate design and operating safeguards. Customer represents and agrees that it has all the necessary expertise to create and implement safeguards which anticipate dangerous consequences of failures, monitor failures and their consequences, lessen the likelihood of failures that might cause harm and take appropriate remedial actions. Silergy assumes no liability related to any default, damage, costs or problem in the customer's applications or products, or the application or use by customer's third-party buyers. Customer will fully indemnify Silergy, its subsidiaries, and their representatives against any damages arising out of the use of any Silergy components in safety-critical applications. It is also buyers' sole responsibility to warrant and guarantee that any intellectual property rights of a third party are not infringed upon when integrating Silergy products into any application. Silergy assumes no responsibility for any said applications or for any use of any circuitry other than circuitry entirely embodied in a Silergy product.

3. **Limited warranty and liability.** Information furnished by Silergy in this document is believed to be accurate and reliable. However, Silergy makes no representation or warranty, expressed or implied, as to the accuracy or completeness of such information and shall have no liability for the consequences of use of such information. In no event shall Silergy be liable for any indirect, incidental, punitive, special or consequential damages, including but not limited to lost profits, lost savings, business interruption, costs related to the removal or replacement of any products or rework charges, whether or not such damages are based on tort or negligence, warranty, breach of contract or any other legal theory. Notwithstanding any damages that customer might incur for any reason whatsoever, Silergy' aggregate and cumulative liability towards customer for the products described herein shall be limited in accordance with the Standard Terms and Conditions of Sale of Silergy.

4. **Suitability for use.** Customer acknowledges and agrees that it is solely responsible for compliance with all legal, regulatory and safety-related requirements concerning its products, and any use of Silergy components in its applications, notwithstanding any applications-related information or support that may be provided by Silergy. Silergy products are not designed, authorized or warranted to be suitable for use in life support, life-critical or safety-critical systems or equipment, nor in applications where failure or malfunction of a Silergy product can reasonably be expected to result in personal injury, death or severe property or environmental damage. Silergy assumes no liability for inclusion and/or use of Silergy products in such equipment or applications and therefore such inclusion and/or use is at the customer's own risk.

5. **Terms and conditions of commercial sale.** Silergy products are sold subject to the standard terms and conditions of commercial sale, as published at <http://www.silergy.com/stdterms>, unless otherwise agreed in a valid written individual agreement specifically agreed to in writing by an authorized officer of Silergy. In case an individual agreement is concluded only the terms and conditions of the respective agreement shall apply. Silergy hereby expressly objects to and denies the application of any customer's general terms and conditions with regard to the purchase of Silergy products by the customer.

6. **No offer to sell or license.** Nothing in this document may be interpreted or construed as an offer to sell products that is open for acceptance or the grant, conveyance or implication of any license under any copyrights, patents or other industrial or intellectual property rights. Silergy makes no representation or warranty that any license, either express or implied, is granted under any patent right, copyright, mask work right, or other intellectual property right. Information published by Silergy regarding third-party products or services does not constitute a license to use such products or services or a warranty or endorsement thereof. Use of such information may require a license from a third party under the patents or other intellectual property of the third party, or a license from Silergy under the patents or other intellectual property of Silergy.

For more information, please visit: [www.silergy.com](http://www.silergy.com)

© 2020 Silergy Corp.

All Rights Reserved.

## X-ON Electronics

Largest Supplier of Electrical and Electronic Components

*Click to view similar products for [Switching Voltage Regulators](#) category:*

*Click to view products by [Silergy](#) manufacturer:*

Other Similar products are found below :

[FAN53610AUC33X](#) [FAN53611AUC123X](#) [EN6310QA](#) [160215](#) [R3](#) [KE177614](#) [FAN53611AUC12X](#) [MAX809TTR](#) [NCV891234MW50R2G](#)  
[AST1S31PUR](#) [NCP81203PMNTXG](#) [NCP81208MNTXG](#) [NCP81109GMNTXG](#) [NCP3235MNTXG](#) [NCP81109JMNTXG](#) [MP2161AGJ-Z](#)  
[NCP81241MNTXG](#) [NTE7223](#) [NTE7222](#) [NTE7224](#) [L6986FTR](#) [MPQ4481GU-AEC1-P](#) [MP8756GD-P](#) [MPQ2171GJ-P](#) [MPQ2171GJ-AEC1-P](#)  
[N JW4153U2-A-TE2](#) [MP2171GJ-P](#) [MP28160GC-Z](#) [MPM3509GQVE-AEC1-P](#) [XDPE132G5CG000XUMA1](#) [LM60440AQRPKRQ1](#)  
[MP5461GC-P](#) [NCV896530MWATXG](#) [MPQ4409GQBE-AEC1-P](#) [S-19903DA-A8T1U7](#) [S-19903CA-A6T8U7](#) [S-19903CA-S8T1U7](#) [S-](#)  
[19902BA-A6T8U7](#) [S-19902CA-A6T8U7](#) [S-19932BA-A6T8U7](#) [S-19932AA-A6T8U7](#) [S-19932BA-A8T1U7](#) [S-19902AA-A6T8U7](#) [S-](#)  
[19903AA-A6T8U7](#) [S-19902AA-S8T1U7](#) [S-19902BA-A8T1U7](#) [AU8310](#) [LMR33630APAQRN XRQ1](#) [LMR33630APCQRN XRQ1](#)  
[LMR54406DBVR](#)