



SY20623D

High Efficiency, 3 A , 2.5V- 6V Input Synchronous Step Down DC/DC converter

General Description

The SY20623D is a step-down module converter with built-in power MOSFETs and inductor. The SY20623D achieves 3A of continuous output current from a 2.5V to 6V input voltage with excellent load and line regulation. It provides accurate regulation for a variety of loads over $T_j = -40^{\circ}\text{C}$ to 125°C . The output voltage can be regulated as low as 0.6V. Only input capacitors, output capacitor and FB resistor divider are needed to complete the design.

The SY20623D adopts the instant PWM architecture to achieve fast transient responses for high step down applications. The device is also equipped with cycle-by-cycle current limit, hiccup over current protection and thermal shutdown protection.

Features

- Wide Input Voltage Range: 2.5V to 6V
- Capable of 3A constant output current
- High Output Voltage Accuracy Over Temperature Range ($T_a -40^{\circ}\text{C}$ to 105°C)
- Instant PWM architecture to achieve fast transient response
- FCCM under all I_o Range
- Pseudo 2.4MHz switching frequency
- Internal Soft-start Limits the Inrush Current
- Reliable Protection Mode:
 - Auto-retry Mode for UVP, UVLO and OTP.
 - Hiccup Mode for OCP
- Power good indicator
- 100% dropout operation
- RoHS Compliant and Halogen Free
- Compact Package: $2.5 \times 2 \times 1.3$ mm

Applications

- Smart Phone
- Telecom Applications
- Light Module

Typical Applications

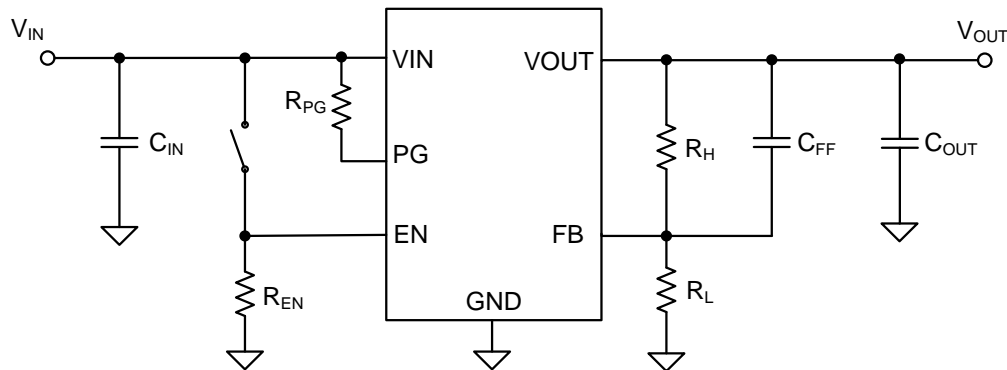

Figure 1. Schematic Diagram



Ordering Information

Ordering Part Number	Package type	Top Mark
SY20623DAFM	MDFN2.5×2-10 RoHS Compliant and Halogen Free	a9xyz

x=year code, y=week code, z= lot number code

Pinout (top view)

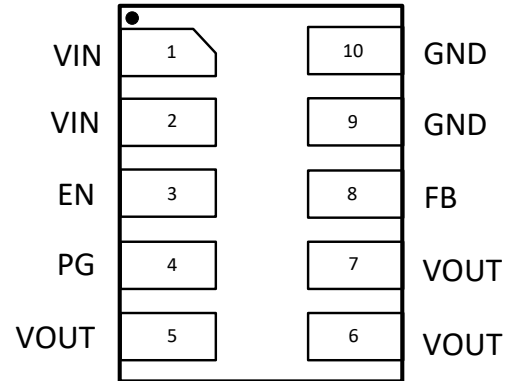

Pin Name	Pin Number	Pin Description
VIN	1,2	Input pin. Decouple this pin to GND pin with at least 20μF ceramic capacitor.
EN	3	Enable pin. Pull high to enable the device. Pull low to disable the device.
PG	4	Power good open drain output pin.
VOUT	5,6,7	Output voltage pin. Decouple this pin to GND pin with at least a 30μF ceramic capacitor.
FB	8	Output Feedback Pin. Connect this pin to the center point of the output resistor divider to program the output voltage: $V_{OUT}=0.6 \times (1+R_H/R_L)$.
GND	9,10	Ground pin.



Block Diagram

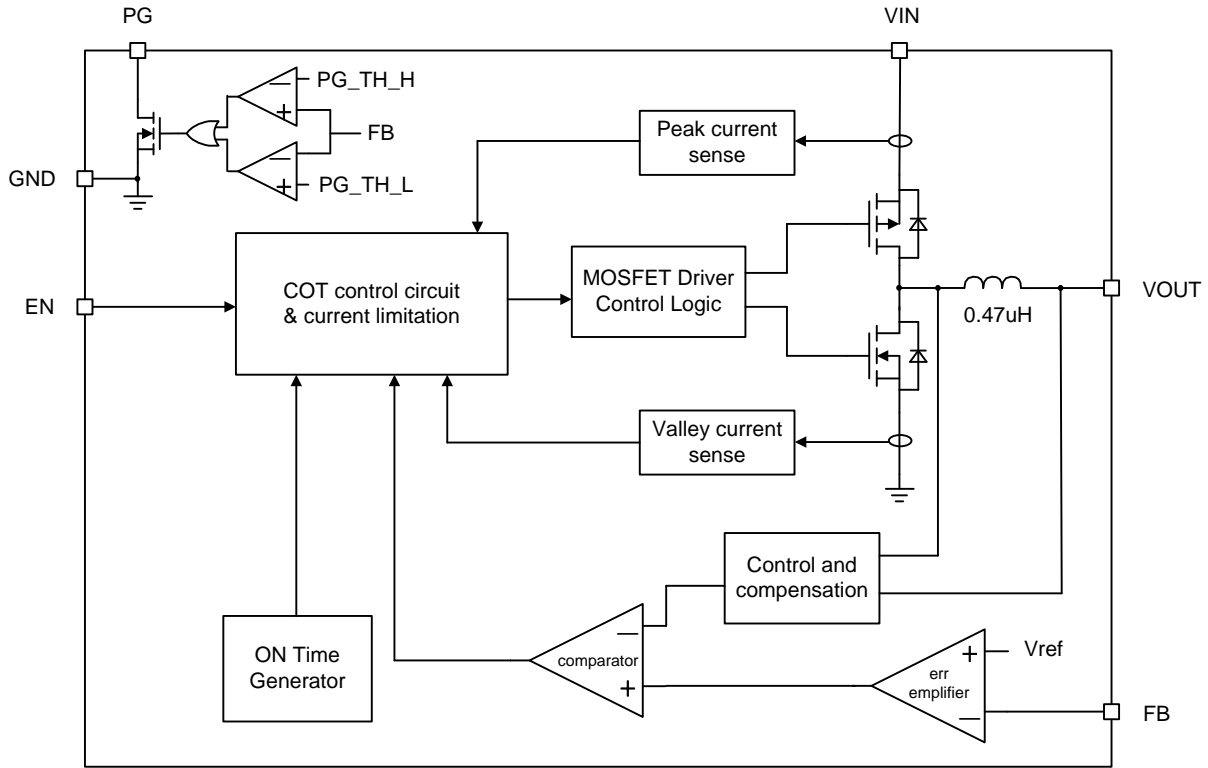

Figure 2. Block Diagram

Absolute Maximum Ratings(Note1)	Min	Max	Unit
IN	0.3	7	V
All Other Pins	-0.3	IN + 0.3	V
Lead Temperature (Soldering, 10 sec.)		260	°C
Storage Temperature Range	-55	125	°C
Junction Temperature, Operating	-40	125	°C

Thermal Information (Note 2)	Min	Max	Unit
Package Thermal Resistance (Note 2)			
θ_{JA}		27	°C/W
Ψ_{JB}		18	°C/W
Power Dissipation , P_D @ $T_A=25^\circ\text{C}$,MDFN		3.7	W

Recommended Operating Conditions (Note 3)	Min	Max	Unit
IN	-0.3	6	V
Output Voltage	0.6	Vin	V
Output Current Range	0	3	A
Junction Temperature Range	-40	125	°C



Electrical Characteristics

Electrical Characteristics $V_{IN} = 3.3V$, $V_O = 1.8V$, $I_O = 3A$, $C_O = 3*10\mu F$, $T_A = 25^\circ C$, FB divider resistor accuracy = 0.5%, unless otherwise specified

Parameter	Symbol	Test Conditions	Min	Typ	Max	Unit
Input Specifications						
Input Voltage Range	V_{IN}		2.5		6	V
Input UVLO Threshold (falling)	$V_{UVLO,FALLING}$	$EN = V_{IN}$	2.1	2.2	2.3	V
Input UVLO Hysteresis	V_{HYS}			200		mV
Input Current with No Load	I_{IN}	$I_O = 0A$	10	16	30	mA
Shutdown Current	I_{SHDN}			0.1	0.5	μA
Output Specifications						
Feedback Reference Voltage	V_{REF}	$T_J = -40^\circ C - 125^\circ C$	0.594	0.6	0.606	V
Load Regulation	ΔV_{LDR}	$T_A = 25^\circ C$, $I_O = 0$ to 3A			± 1	%
Line Regulation	ΔV_{LNR}	$V_{IN} = 2.5 - 6V$, $I_O = 3A$			± 0.5	%
Temperature Regulation	ΔT	$T_A = -40^\circ C$ to $105^\circ C$, $I_O = 3A$			± 2	%
Bottom FET Valley Current Limit	$I_{LIM,BOT}$			5		A
Rise Time	t_{RISE}	From EN high to 95% of V_{OUT} nominal	0	0.3	1	ms
General Specifications						
Switching Frequency	f_{SW}		1.92	2.4	2.88	MHz
Thermal Shutdown Temperature	T_{SD}			150		$^\circ C$
Thermal Shutdown Hysteresis	T_{HYS}			20		$^\circ C$
Maximum Duty Cycle (Note 4)	D_{MAX}		100			%
Min On Time	$t_{ON,MIN}$			50		ns
Signal Specifications						
EN Pin Logic High Threshold (rising)	V_{EN}		1.0			V
EN Hysteresis	$V_{EN,HYS}$			0.6		V
EN Pull-down Resistance	R_{EN}	EN Low	300	400	500	$k\Omega$
		V_{OUT} rising	93.5	95	97.5	%
Power Good Asserts Threshold	$V_{PG,ASSERTS}$	V_{OUT} falling	86	88	91	%

Note 1: Stresses beyond the “Absolute Maximum Ratings” may cause permanent damage to the device. These are stress ratings only. Functional operation of the device at these or any other conditions beyond those indicated in the operational sections of the specification is not implied. Exposure to absolute maximum rating conditions for extended periods may affect device reliability.

Note 2: θ_{JA} and Ψ_{JB} are based on a four-layer Silergy Evaluation Board in the natural convection at $T_A = 25^\circ C$. Board temperature refers to the PCB point to the hottest IC pin with a 1mm distance on the same PCB surface layer.

Note 3: The device is not guaranteed to function outside its operating conditions.

Note 4: The values are guaranteed by design.

Typical Performance Characteristics

($C_{OUT} = 3 \times 10 \mu\text{F}$, $T_A = 25^\circ\text{C}$, resistor tolerance is $\pm 1\%$, unless otherwise specified.)

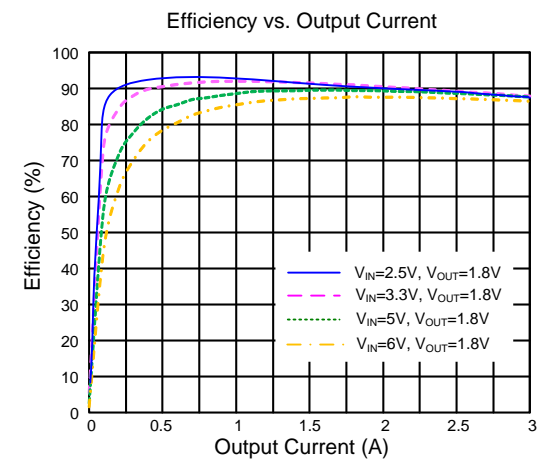
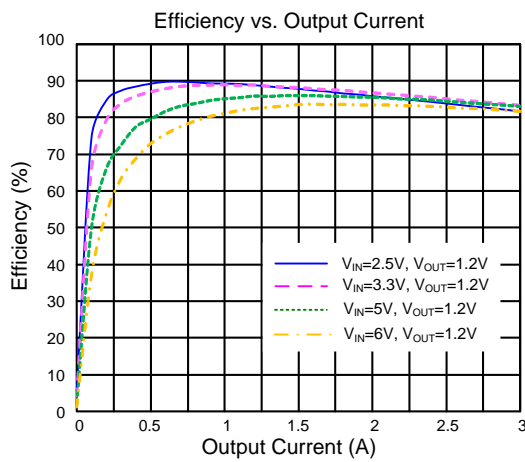
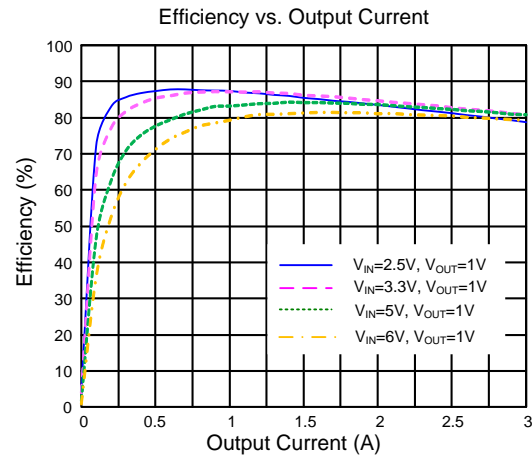
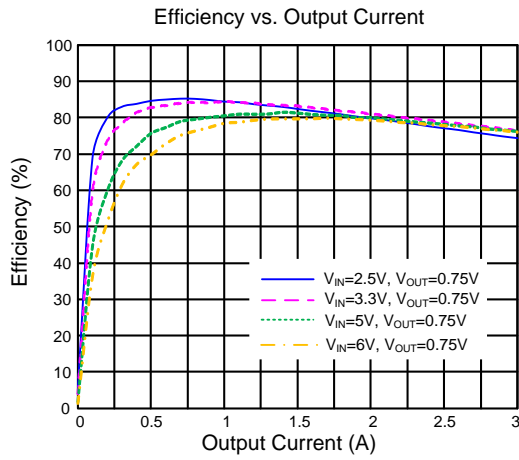

$V_{OUT}=0.75\text{V}$

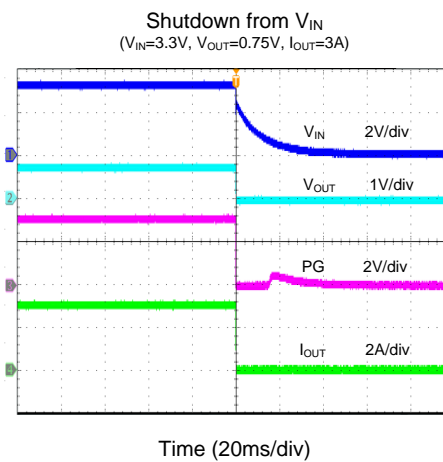
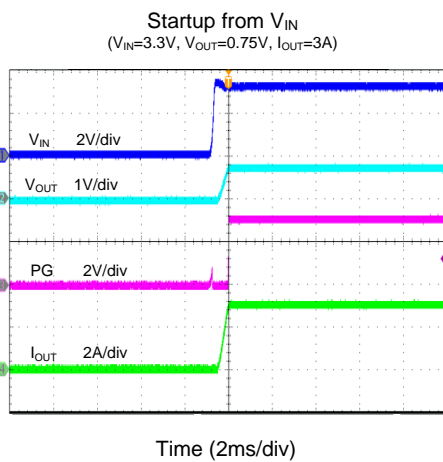

Startup from EN
($V_{IN}=3.3V$, $V_{OUT}=0.75V$, $I_{OUT}=3A$)

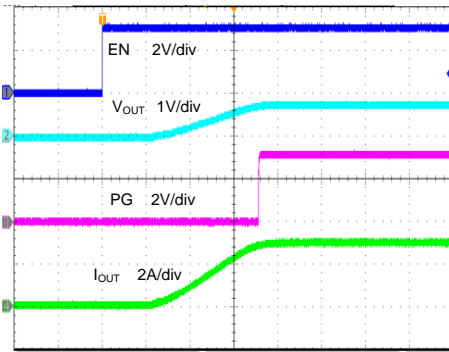

Time (200 μ s/div)

Shutdown from EN
($V_{IN}=3.3V$, $V_{OUT}=0.75V$, $I_{OUT}=3A$)

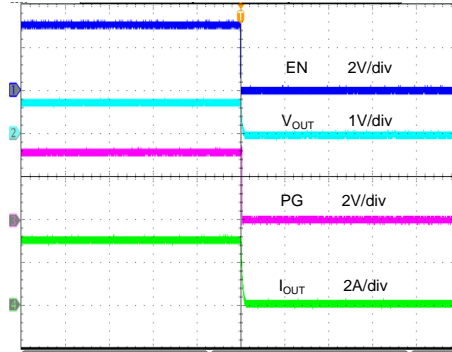

Time (200 μ s/div)

Short Circuit Protection
($V_{IN}=3.3V$, $V_{OUT}=0.75V$, $I_{OUT}=0A$ -Short)

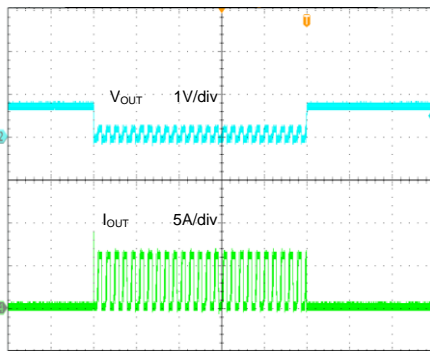

Time (10ms/div)

Short Circuit Protection
($V_{IN}=3.3V$, $V_{OUT}=0.75V$, $I_{OUT}=3A$ -Short)

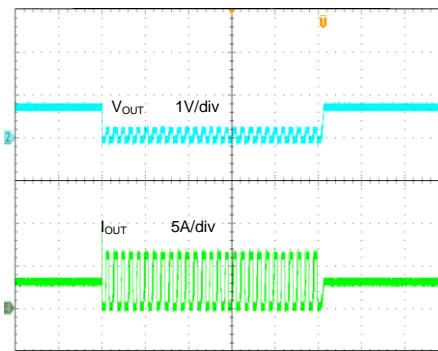

Time (10ms/div)

Output Ripple
($V_{IN}=3.3V$, $V_{OUT}=0.75V$, $I_{OUT}=3A$)

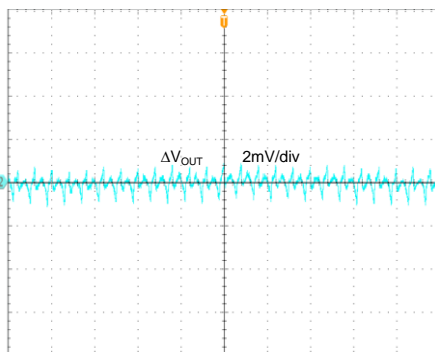

Time (1 μ s/div)

Output Ripple
($V_{IN}=3.3V$, $V_{OUT}=0.75V$, $I_{OUT}=0A$)

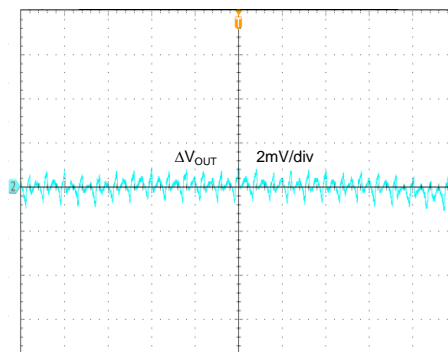

Time (1 μ s/div)

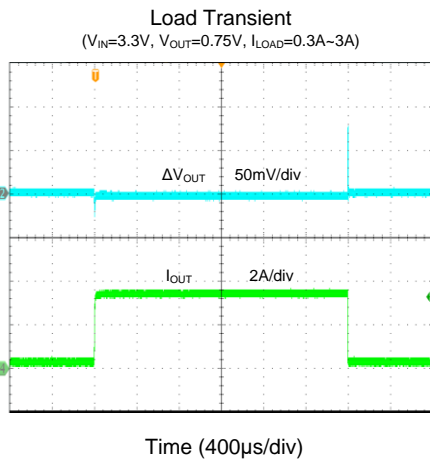

$V_{OUT}=1V$

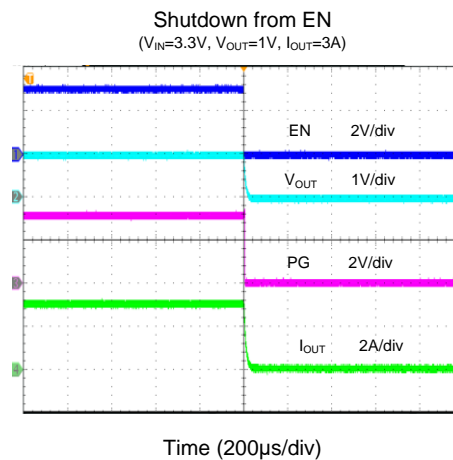
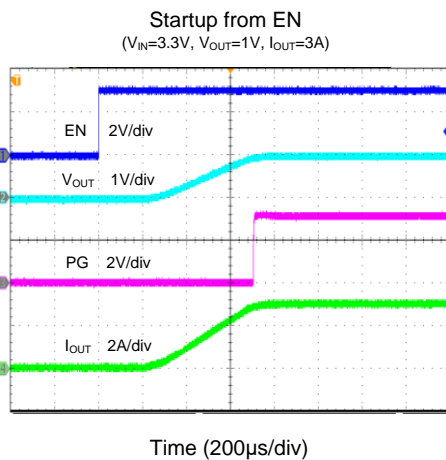
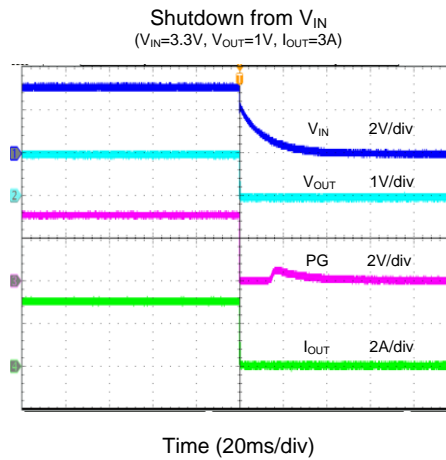
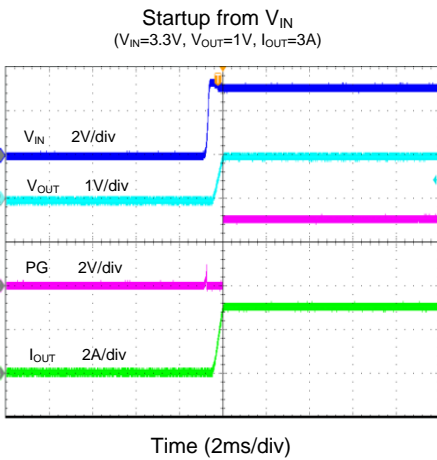

Short Circuit Protection
 ($V_{IN}=3.3V$, $V_{OUT}=1V$, $I_{OUT}=0A$ -Short)

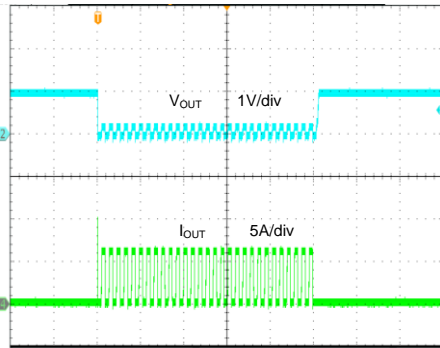

Time (10ms/div)

Short Circuit Protection
 ($V_{IN}=3.3V$, $V_{OUT}=1V$, $I_{OUT}=3A$ -Short)

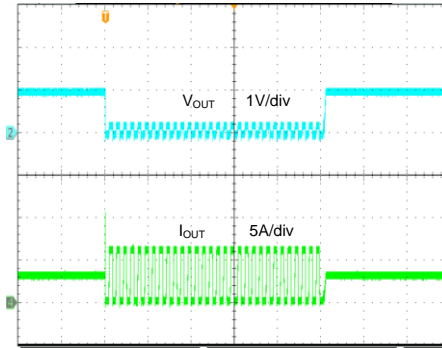

Time (10ms/div)

Output Ripple
 ($V_{IN}=3.3V$, $V_{OUT}=1V$, $I_{OUT}=3A$)

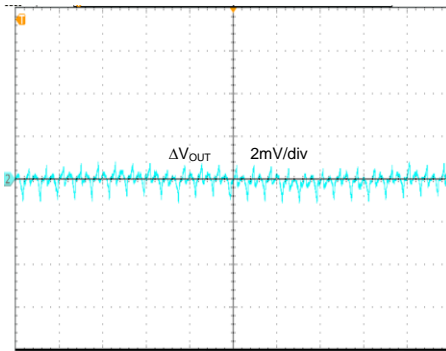

Time (1μs/div)

Output Ripple
 ($V_{IN}=3.3V$, $V_{OUT}=1V$, $I_{OUT}=0A$)

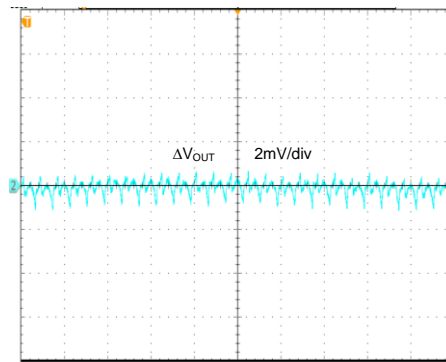

Time (1μs/div)

Load Transient
 ($V_{IN}=3.3V$, $V_{OUT}=1V$, $I_{OUT}=0.3A$ - $3A$)

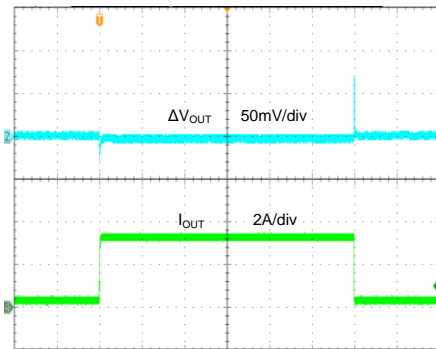

Time (400μs/div)



SILERGY

SY20623D

V_{OUT}=1.2V

Startup from V_{IN}
(V_{IN}=3.3V, V_{OUT}=1.2V, I_{OUT}=3A)

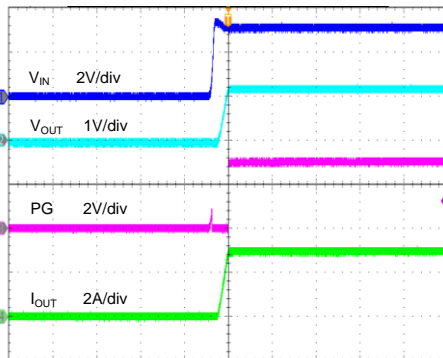

Time (2ms/div)

Shutdown from V_{IN}
(V_{IN}=3.3V, V_{OUT}=1.2V, I_{OUT}=3A)

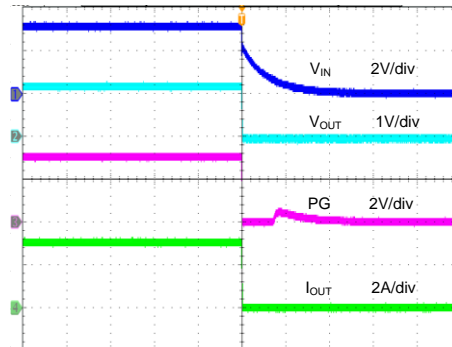

Time (20ms/div)

Startup from EN
(V_{IN}=3.3V, V_{OUT}=1.2V, I_{OUT}=3A)

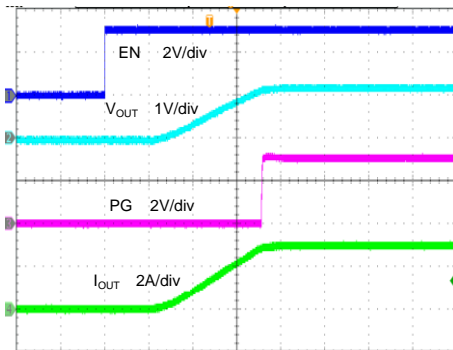

Time (200μs/div)

Shutdown from EN
(V_{IN}=3.3V, V_{OUT}=1.2V, I_{OUT}=3A)

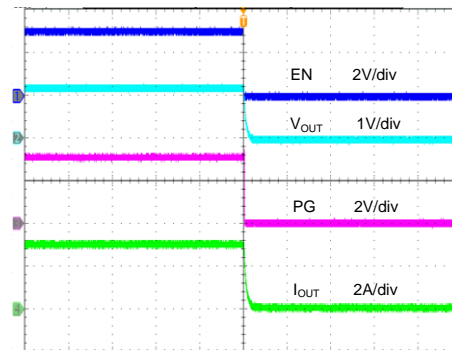

Time (200μs/div)

Short Circuit Protection
(V_{IN}=3.3V, V_{OUT}=1.2V, I_{OUT}=0A-Short)

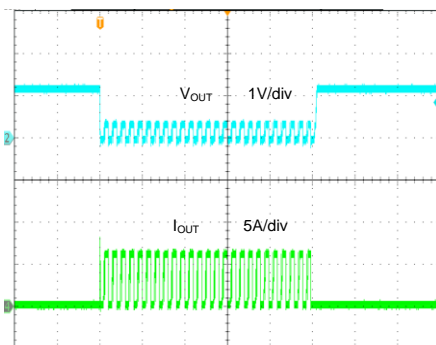

Time (10ms/div)

Short Circuit Protection
(V_{IN}=3.3V, V_{OUT}=1.2V, I_{OUT}=3A-Short)

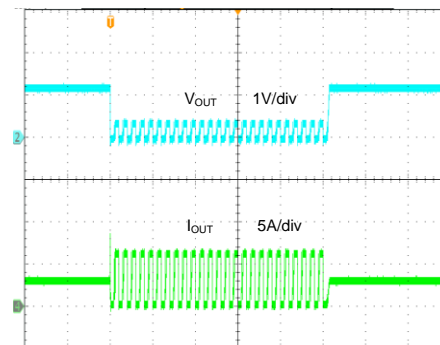

Time (10ms/div)

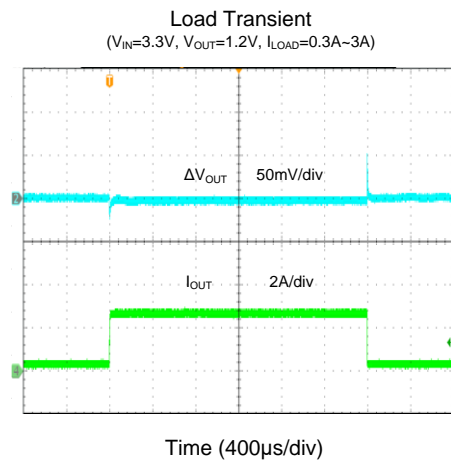
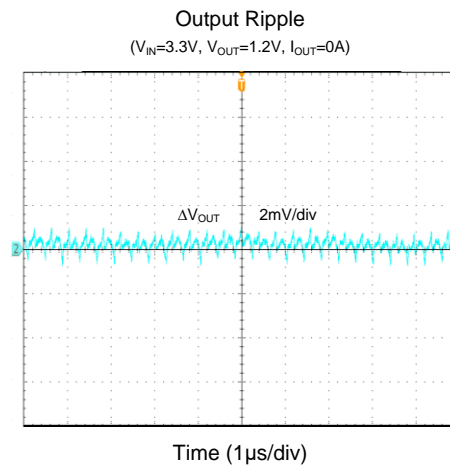
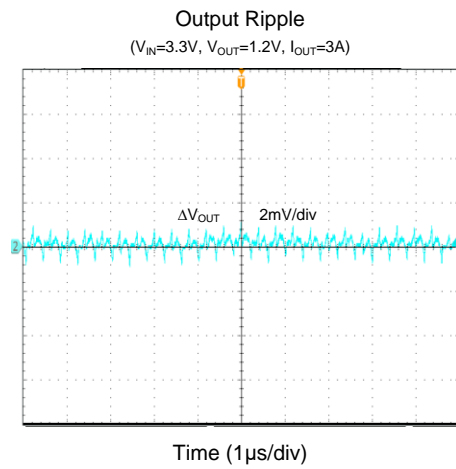



SILERGY

SY20623D

$V_{OUT}=1.8V$

Startup from V_{IN}
($V_{IN}=3.3V$, $V_{OUT}=1.8V$, $I_{OUT}=3A$)

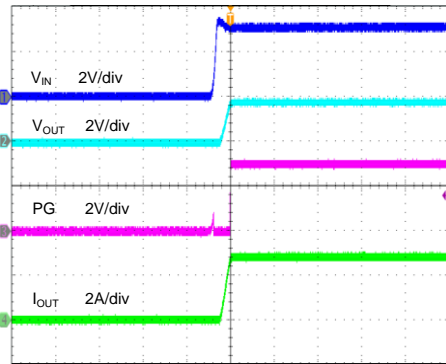

Time (2ms/div)

Shutdown from V_{IN}
($V_{IN}=3.3V$, $V_{OUT}=1.8V$, $I_{OUT}=3A$)

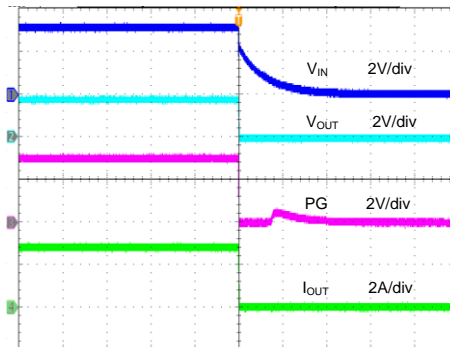

Time (20ms/div)

Startup from EN
($V_{IN}=3.3V$, $V_{OUT}=1.8V$, $I_{OUT}=3A$)

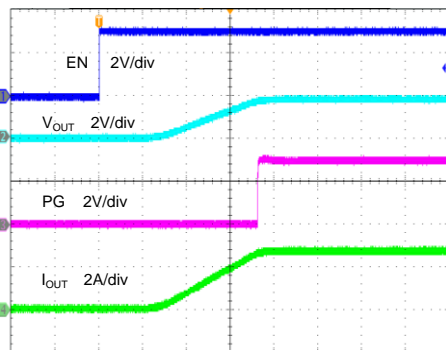

Time (200µs/div)

Shutdown from EN
($V_{IN}=3.3V$, $V_{OUT}=1.8V$, $I_{OUT}=3A$)

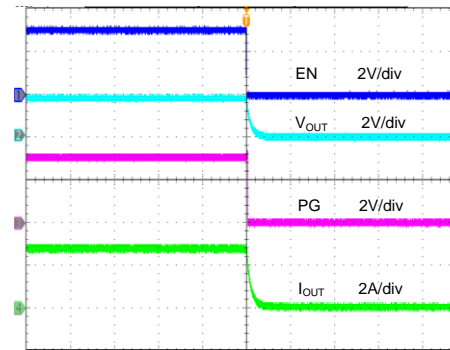

Time (200µs/div)

Short Circuit Protection
($V_{IN}=3.3V$, $V_{OUT}=1.8V$, $I_{OUT}=0A$ -Short)

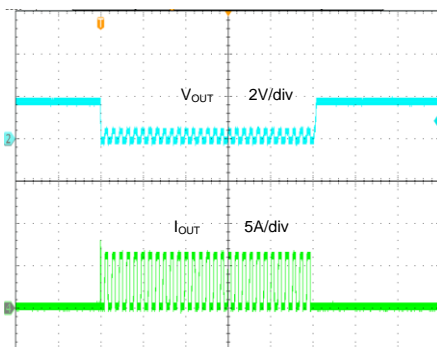

Time (10ms/div)

Short Circuit Protection
($V_{IN}=3.3V$, $V_{OUT}=1.8V$, $I_{OUT}=3A$ -Short)

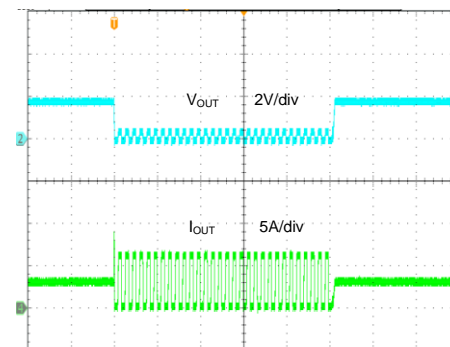

Time (10ms/div)

Output Ripple
($V_{IN}=3.3V$, $V_{OUT}=1.8V$, $I_{OUT}=3A$)

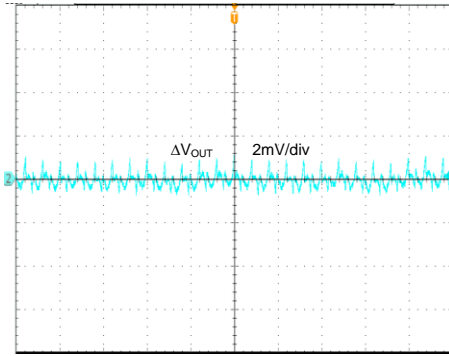

Time (1µs/div)

Output Ripple
($V_{IN}=3.3V$, $V_{OUT}=1.8V$, $I_{OUT}=0A$)

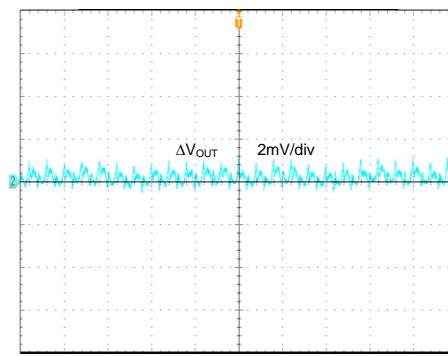

Time (1µs/div)

Load Transient
($V_{IN}=3.3V$, $V_{OUT}=1.8V$, $I_{LOAD}=0.3A-3A$)

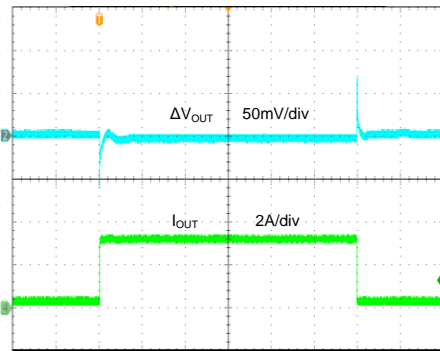

Time (400µs/div)

Bode Plot
($V_{IN}=3.3V$, $V_{OUT}=0.75V$, $I_{OUT}=3A$)

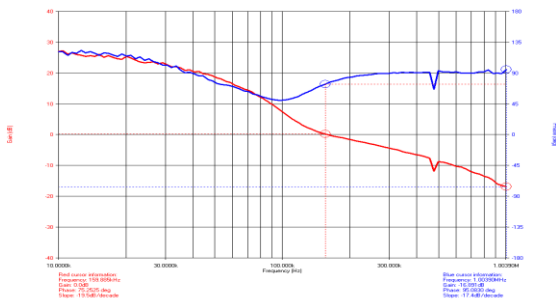

Bode Plot
($V_{IN}=3.3V$, $V_{OUT}=1V$, $I_{OUT}=3A$)

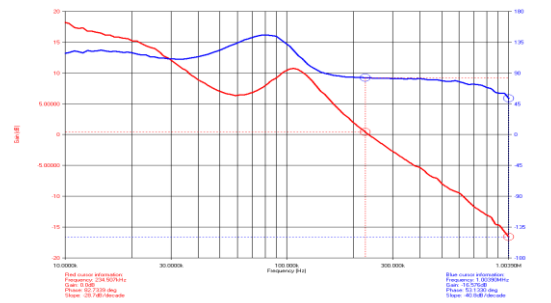

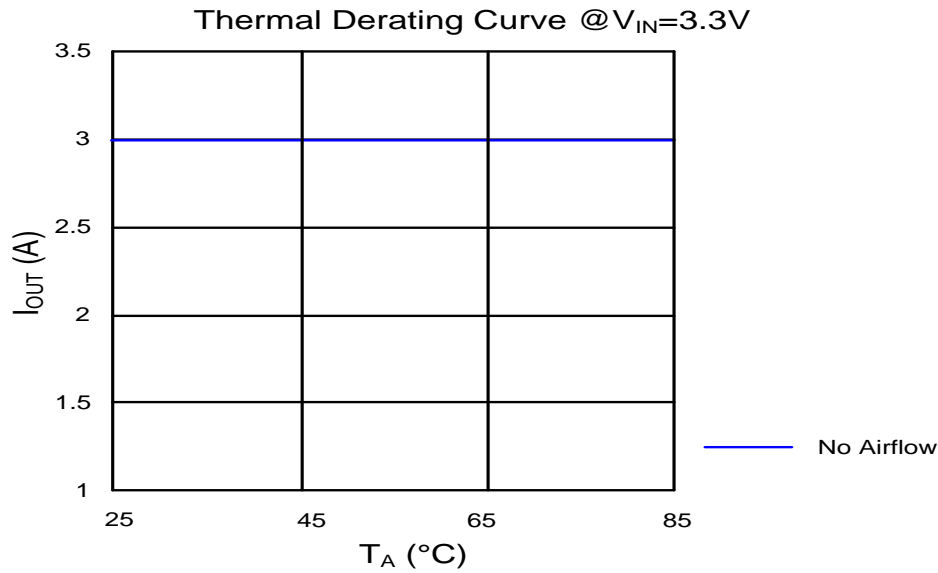
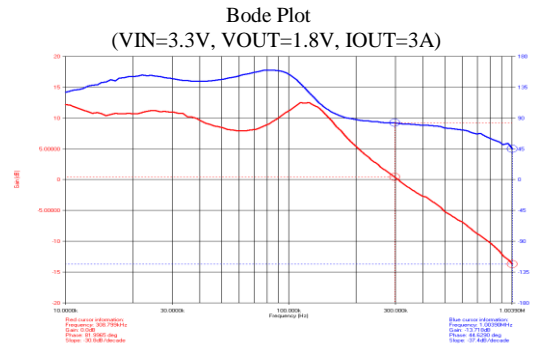
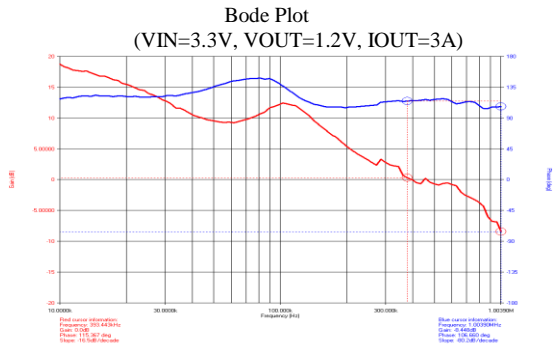

Notes:

- 1) T_A: Air temperature, 0.5 inch above IC.
- 2) Based on a four-layer Silergy Evaluation Board in the natural convection.
- 3) The inductor's temperature is not beyond 115°C under this TD curve.
- 4) For customer's specific application, the recommended inductor temperature limitation is 115°C.

Operation General Description

The SY20623D is a high efficiency 2.4MHz synchronous step-down DC/DC regulator which is capable of delivering up to 3A output currents. It can operate over a wide input voltage range from 2.5V to 6V and integrate main switch and synchronous switch with very low $R_{DS(ON)}$ to minimize the conduction loss.

Low output voltage ripple, small external inductor and capacitor sizes are achieved with 2.4MHz switching frequency.

Applications Information

Because of the high integration in the SY20623D, the application circuit based on this regulator is rather simple. Only the input capacitor C_{IN} , the output capacitor C_{OUT} , and the feedback resistors (R_H and R_L) need to be selected for the targeted application specifications.

Feedback Resistor Dividers R_H and R_L

Choose R_H and R_L to program the proper output voltage. To minimize the power consumption under light loads, it is desirable to choose large resistance values for both R_H and R_L . A value between 10k Ω and 1M Ω is highly recommended for both resistors. If $R_H = 100k\Omega$ is chosen, then R_L can be calculated to be:

$$R_L = \frac{0.6V \times R_H}{(V_{OUT} - 0.6V)}$$

Input Capacitor C_{IN}

To minimize the potential noise problem, place a typical X7R or better grade ceramic capacitor with higher than 10V rating and greater than 20 μ F capacitance, Place this ceramic capacitor really close to the IN and GND pins. Care should be taken to minimize the loop area formed by the C_{IN} , and the IN/GND pins.

External Capacitor Recommendation

	Description	Vendor	PN
C_{IN}	10 μ F/10V/X7R, 0603	Murata	GRM188D71A106KA73#

Output Capacitor C_{OUT}

The output capacitor is selected to handle the output ripple noise requirements. Both steady state ripple and transient requirements must be taken into consideration when selecting this capacitor. For the best performance, it is recommended to use X7R or better grade ceramic capacitor with higher than 6.3V rating and greater than 30 μ F capacitance. Place this ceramic capacitor really close to the OUT and GND pins to minimize the loop area formed by the C_{OUT} , and the OUT/GND pins.

External Capacitor Recommendation

	Description	Vendor	PN
C_{OUT}	10 μ F/6.3V/X7T, 0603	Murata	GRM188D70J106MA73D

If the output capacitance is larger than 100 μ F or other type of capacitor (polymer, tantalum...) is used, please contact Silergy supporting team to get more assessment.

Over Current Protection

With load current increasing, as soon as the high side power FET current gets higher than peak current limit threshold, the high side power FET will turn off and the low side power FET will keep turning on until low side power FET current decrease below the valley current limit threshold. If the load current continues to increase, the output voltage will drop.

Thermal Shutdown Protection

If the junction temperature of SY20623D is higher than the thermal shutdown temperature (typical 150 $^{\circ}$ C), the IC will turn off both high side power FET and low side power FET, and then enters thermal shutdown protection mode. It will remain in this state until the junction temperature decreases below 130 $^{\circ}$ C. After exiting this state, the IC auto retries to normal operation.



Application Schematic ($V_{OUT}=1.2V$)

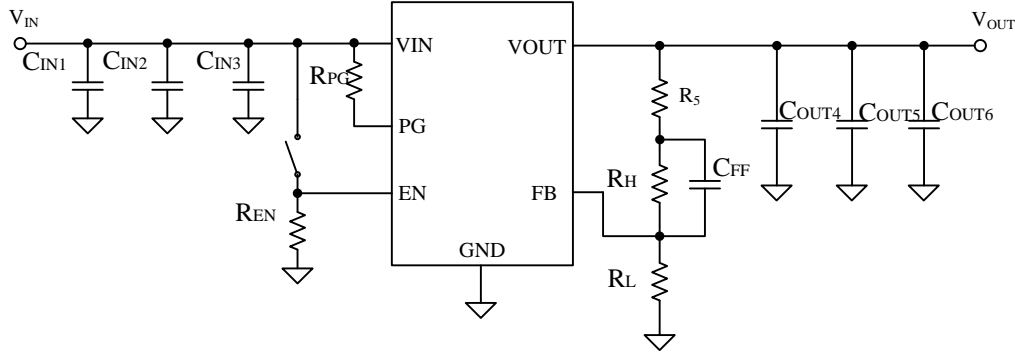

BOM List

Reference Designator	Description	Part Number	Manufacturer
CIN1	47 μ F/25V Electrolytic Cap		
CIN2,CIN3	10uF/10V/X7R,0603	GRM188D71A106KA73#	murata
COUT4,COUT5,COUT6	10uF/6.3V/X7T,0603	GRM188D70J106MA73D	murata
RH ,RPG	100k Ω ,1%,0603		
RL	100k Ω ,1%,0603($V_{OUT}=1.2V$)		
REN	1M Ω ,1%,0603		
R5	0 Ω ,1%,0603		
CFF	120pF/100V/C0G,0603	GCM1885C2A121JA16#	murata

Recommend Table for Typical Applications

$V_{OUT}(V)$	$R_2(K\Omega)$	$R_1(K\Omega)$	$C_7(pF)$
0.6	0	100	120
1.2	100	100	120
1.8	50	100	120
3.3	22.1	100	120

Layout Design

To achieve a higher efficiency and better noise immunity, following components should be placed close to the IC: C_{IN} and C_{OUT} .

- 1) C_{IN} must be close to the pins IN and GND. The loop area formed by C_{IN} and GND must be minimized.
- 2) C_{OUT} must be close to the pins OUT and GND. The loop area formed by C_{OUT} and GND must be minimized.
- 3) Place the FB components (R_H , R_L) as close to the FB pin as possible. Avoid routing the FB trace near LX as it is noise sensitive.
- 4) It is desirable to maximize the PCB copper area connecting to the GND pin to achieve the best thermal and noise performance. If the board space allowed, a ground plane is highly desirable.

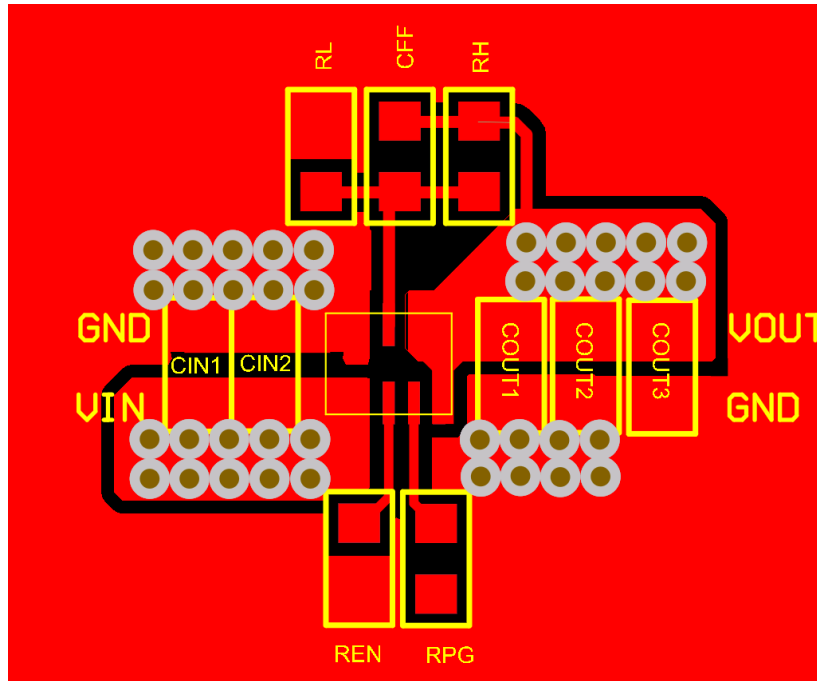
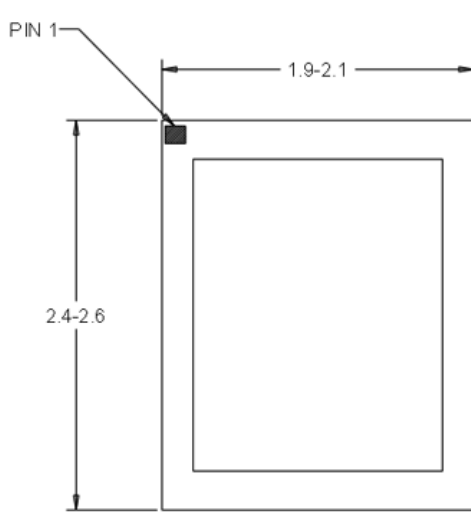
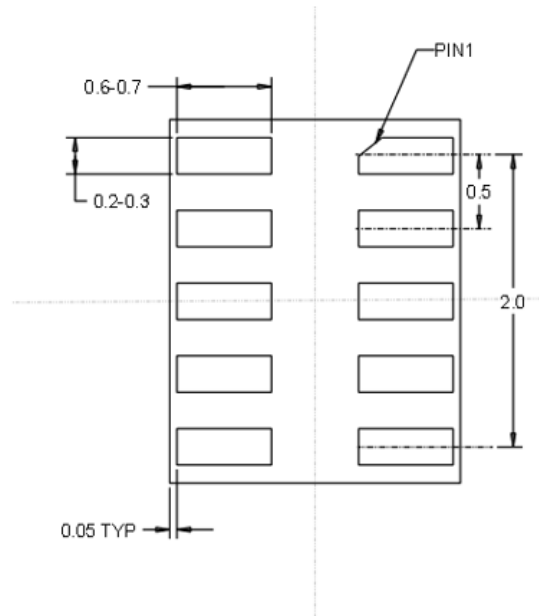

Figure 3. PCB Layout Suggestion

MDFN2.5×2-10 Package Outline Drawing



Top View



Bottom View

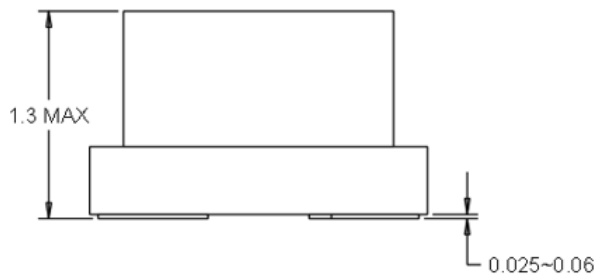

Side View

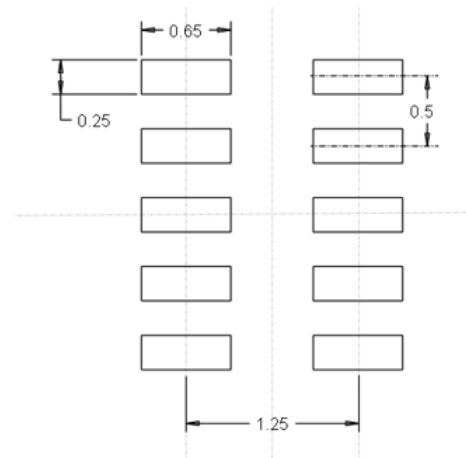

**Recommended PCB layout
(Reference Only)**

Notes: 1, All dimension in millimeter and exclude mold flash & metal burr.

Taping & Reel Specification

1. MDFN2.5x2 taping orientation

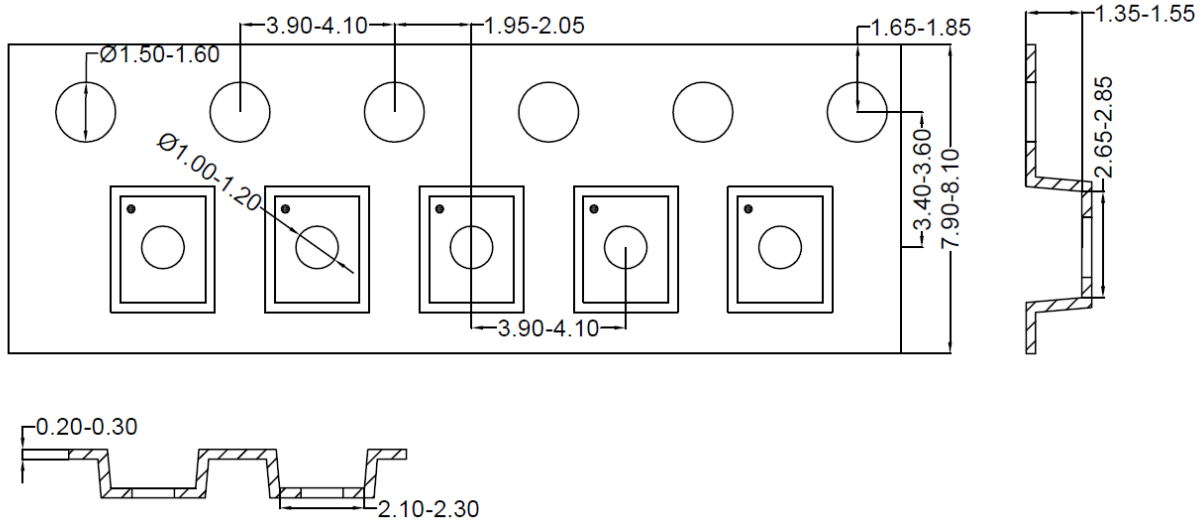

Feeding direction →

2. Carrier Tape & Reel specification for packages

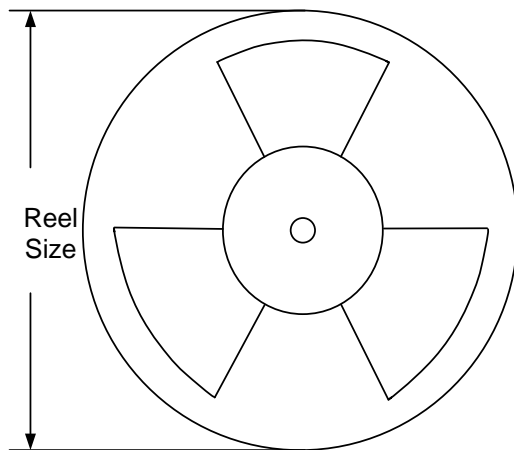

Package type	Tape width (mm)	Pocket pitch(mm)	Reel size (Inch)	Trailer length(mm)	Leader length (mm)	Qty per reel
MDFN2.5x2	8	4	7"	400	160	2500

3. Others: NA









SILERGY

SY20623D

Packaging Information\

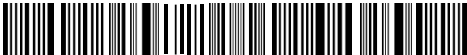
Device Marking: a9

Label Information

W/O: XXXXXXXXXXXX		
		
P/N: SY20623DAFM	MSL1	
		
QTY: 2500		 Pb-Free
		
D/C Lot: XXXXXXXXXXXX		RoHS Compliant Halogen Free
	(The barcode is for demonstration only.)	

IMPORTANT NOTICE

1. **Right to make changes.** Silergy and its subsidiaries (hereafter Silergy) reserve the right to change any information published in this document, including but not limited to circuitry, specification and/or product design, manufacturing or descriptions, at any time and without notice. This document supersedes and replaces all information supplied prior to the publication hereof. Buyers should obtain the latest relevant information before placing orders and should verify that such information is current and complete. All semiconductor products are sold subject to Silergy's standard terms and conditions of sale.
2. **Applications.** Application examples that are described herein for any of these products are for illustrative purposes only. Silergy makes no representation or warranty that such applications will be suitable for the specified use without further testing or modification. Buyers are responsible for the design and operation of their applications and products using Silergy products. Silergy or its subsidiaries assume no liability for any application assistance or designs of customer products. It is customer's sole responsibility to determine whether the Silergy product is suitable and fit for the customer's applications and products planned. To minimize the risks associated with customer's products and applications, customer should provide adequate design and operating safeguards. Customer represents and agrees that it has all the necessary expertise to create and implement safeguards which anticipate dangerous consequences of failures, monitor failures and their consequences, lessen the likelihood of failures that might cause harm and take appropriate remedial actions. Silergy assumes no liability related to any default, damage, costs or problem in the customer's applications or products, or the application or use by customer's third-party buyers. Customer will fully indemnify Silergy, its subsidiaries, and their representatives against any damages arising out of the use of any Silergy components in safety-critical applications. It is also buyers' sole responsibility to warrant and guarantee that any intellectual property rights of a third party are not infringed upon when integrating Silergy products into any application. Silergy assumes no responsibility for any said applications or for any use of any circuitry other than circuitry entirely embodied in a Silergy product.
3. **Limited warranty and liability.** Information furnished by Silergy in this document is believed to be accurate and reliable. However, Silergy makes no representation or warranty, expressed or implied, as to the accuracy or completeness of such information and shall have no liability for the consequences of use of such information. In no event shall Silergy be liable for any indirect, incidental, punitive, special or consequential damages, including but not limited to lost profits, lost savings, business interruption, costs related to the removal or replacement of any products or rework charges, whether or not such damages are based on tort or negligence, warranty, breach of contract or any other legal theory. Notwithstanding any damages that customer might incur for any reason whatsoever, Silergy' aggregate and cumulative liability towards customer for the products described herein shall be limited in accordance with the Standard Terms and Conditions of Sale of Silergy.
4. **Suitability for use.** Customer acknowledges and agrees that it is solely responsible for compliance with all legal, regulatory and safety-related requirements concerning its products, and any use of Silergy components in its applications, notwithstanding any applications-related information or support that may be provided by Silergy. Silergy products are not designed, authorized or warranted to be suitable for use in life support, life-critical or safety-critical systems or equipment, nor in applications where failure or malfunction of a Silergy product can reasonably be expected to result in personal injury, death or severe property or environmental damage. Silergy assumes no liability for inclusion and/or use of Silergy products in such equipment or applications and therefore such inclusion and/or use is at the customer's own risk.
5. **Terms and conditions of commercial sale.** Silergy products are sold subject to the standard terms and conditions of commercial sale, as published at <http://www.silergy.com/stdterms>, unless otherwise agreed in a valid written individual agreement specifically agreed to in writing by an authorized officer of Silergy. In case an individual agreement is concluded only the terms and conditions of the respective agreement shall apply. Silergy hereby expressly objects to and denies the application of any customer's general terms and conditions with regard to the purchase of Silergy products by the customer.
6. **No offer to sell or license.** Nothing in this document may be interpreted or construed as an offer to sell products that is open for acceptance or the grant, conveyance or implication of any license under any copyrights, patents or other industrial or intellectual property rights. Silergy makes no representation or warranty that any license, either express or implied, is granted under any patent right, copyright, mask work right, or other intellectual property right. Information published by Silergy regarding third-party products or services does not constitute a license to use such products or services or a warranty or endorsement thereof. Use of such information may require a license from a third party under the patents or other intellectual property of the third party, or a license from Silergy under the patents or other intellectual property of Silergy.

For more information, please visit: www.silergy.com

© 2021 Silergy Corp.

All Rights Reserved.

X-ON Electronics

Largest Supplier of Electrical and Electronic Components

Click to view similar products for [Switching Voltage Regulators](#) category:

Click to view products by [Silergy](#) manufacturer:

Other Similar products are found below :

[FAN53610AUC33X](#) [FAN53611AUC123X](#) [EN6310QA](#) [160215](#) [R3](#) [KE177614](#) [FAN53611AUC12X](#) [MAX809TTR](#) [NCV891234MW50R2G](#)
[AST1S31PUR](#) [NCP81203PMNTXG](#) [NCP81208MNTXG](#) [NCP81109GMNTXG](#) [NCP3235MNTXG](#) [NCP81109JMNTXG](#) [MP2161AGJ-Z](#)
[NCP81241MNTXG](#) [NTE7223](#) [NTE7222](#) [NTE7224](#) [L6986FTR](#) [MPQ4481GU-AEC1-P](#) [MP8756GD-P](#) [MPQ2171GJ-P](#) [MPQ2171GJ-AEC1-P](#)
[N JW4153U2-A-TE2](#) [MP2171GJ-P](#) [MP28160GC-Z](#) [MPM3509GQVE-AEC1-P](#) [XDPE132G5CG000XUMA1](#) [LM60440AQRPKRQ1](#)
[MP5461GC-P](#) [NCV896530MWATXG](#) [MPQ4409GQBE-AEC1-P](#) [S-19903DA-A8T1U7](#) [S-19903CA-A6T8U7](#) [S-19903CA-S8T1U7](#) [S-](#)
[19902BA-A6T8U7](#) [S-19902CA-A6T8U7](#) [S-19932BA-A6T8U7](#) [S-19932AA-A6T8U7](#) [S-19932BA-A8T1U7](#) [S-19902AA-A6T8U7](#) [S-](#)
[19903AA-A6T8U7](#) [S-19902AA-S8T1U7](#) [S-19902BA-A8T1U7](#) [AU8310](#) [LMR33630APAQRN XRQ1](#) [LMR33630APCQRN XRQ1](#)
[LMR54406DBVR](#)