

General Description

The SY20733B is a low-voltage, low-dropout voltage regulator capable of sourcing 500mA with a built-in negative metal-oxide-semiconductor (NMOS). A separate bias rail is provided to enable an input voltage range of 0.8V to 5.5V. The output voltage can be configured using a resistor divider and provides a voltage accuracy of $\pm 1\%$.

The SY20733B is available in a compact DFN1.2mm \times 1.2mm-6 pin package.

Features

- Input Voltage Range: 0.8V-5.5V
- Bias Voltage Range: 2.4V-5.5V
- Output Voltage Accuracy: $\pm 1\%$
- Bias Input Quiescent Current: 110 μ A (typ.)
- Bias Shutdown current: 0.1 μ A (typ.)
- Up to 500mA Output Current
- Current Limit Protection
- Over Temperature Shutdown
- Output Auto-Discharge Resistor: 130 Ω
- RoHS Compliant and Halogen Free
- Compact Package: DFN1.2 \times 1.2-6

Applications

- Battery-Powered Equipment
- Smartphones, Tablets
- Cameras, DVRs, STB and Camcorders

Typical Applications

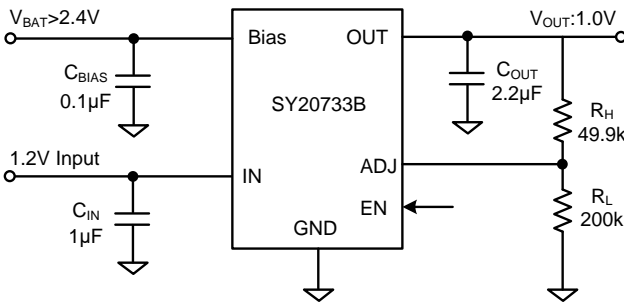

Figure 1. Schematic Diagram

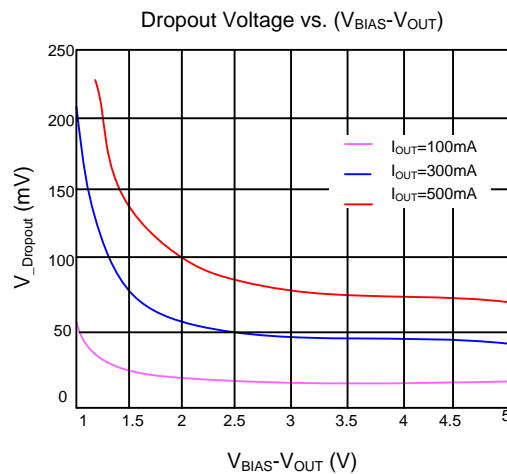

Figure 2. Dropout Curve

Ordering Information

Ordering Part Number	Package Type	Top Mark
SY20733BSCC	DFN1.2x1.2-6 RoHS Compliant and Halogen Free	Hxyz

x=year code, y=week code, z=lot number code

Pinout (top view)

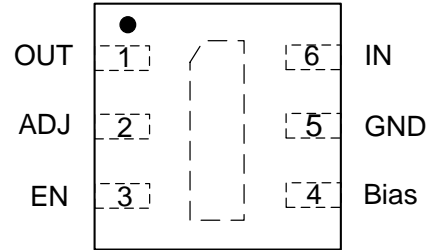

Pin Number	Symbol	Pin Description
1	OUT	Output pin. Decouple this pin to the GND with at least a 2.2μF ceramic capacitor.
2	ADJ	Output voltage programming pin. Connect this pin to the center point of the output resistor divider (as shown in Figure 1) to program the output voltage: $V_{OUT}=0.8V \times (1+R_H/R_L)$.
3	EN	Enable control pin. Pull high to enable the regulator. Pull low to shut down the regulator. Do not leave it floating.
4	Bias	Bias voltage supply for internal control circuits. Decouple this pin to GND with at least a 0.1μF ceramic capacitor.
5	GND	Ground pin.
6	IN	Input voltage supply pin. Decouple this pin to GND with at least a 1μF ceramic capacitor.

Block Diagram

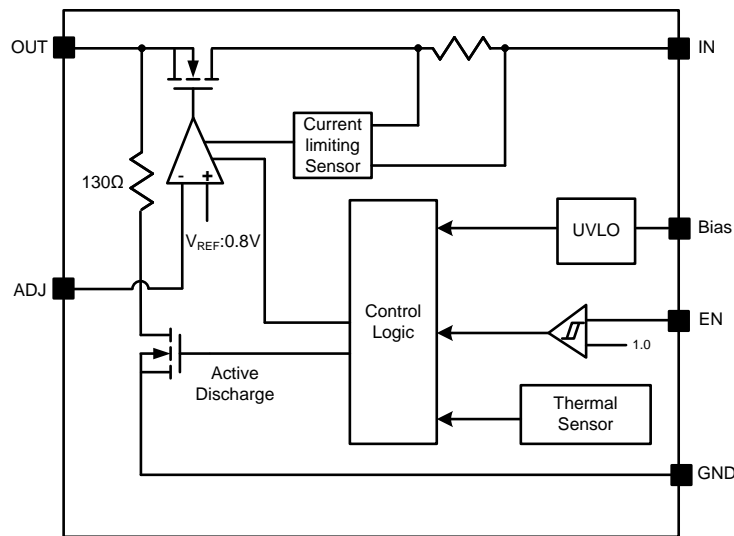

Figure 3. Block Diagram

**Absolute Maximum Ratings**

Parameter (Note1)	Min	Max	Unit
IN, OUT, Bias, EN, ADJ	-0.3	6	V
Lead Temperature (Soldering, 10 sec.)		260	
Junction Temperature, Operating	-40	150	°C
Storage Temperature	-65	150	

Thermal Information

Parameter (Note2)	Typ	Unit
θ_{JA} Junction-to-ambient Thermal Resistance	70	°C/W
θ_{JC} Junction-to-case Thermal Resistance	12	
P_D Power Dissipation $T_A = 25^\circ\text{C}$	1.4	W

Recommended Operating Conditions

Parameter (Note 3)	Min	Max	Unit
Bias Input Voltage	2.4	5.5	
IN	0.8	5.5	V
OUT	0.8	$V_{\text{Bias}} - 1.4$	
Junction Temperature, Operating	-40	125	°C
Ambient Temperature	-40	85	



Electrical Characteristics

($V_{IN}=1.2V$, $V_{OUT}=1.0V$, $V_{Bias}=3.3V$, $I_{OUT}=1mA$, $C_{IN}=1.0\mu F$, $C_{OUT}=2.2\mu F$, $T_A = 25^\circ C$ unless otherwise specified.)

Parameter	Symbol	Test Conditions	Min	Typ.	Max	Unit
Input Voltage Range	V_{IN}		$V_{OUT}+V_{DO}$		5.5	V
Bias Input Voltage	V_{Bias}		2.4		5.5	V
Bias Supply Current	I_{Bias}			110		μA
Bias Shutdown Current	I_{SD}	$V_{EN}=0$		0.1	1	μA
Feedback Reference Voltage	V_{REF}		0.792	0.8	0.808	V
Current Limit	I_{LIM}		500			mA
Load Regulation	V_{LOAD}	$I_{OUT}: 1mA\sim 500mA$		2		mV
V_{Bias} Line Regulation	$\frac{\Delta V_{OUT}}{\Delta V_{Bias}}$	2.7 V or ($V_{OUT(NOM)} + 1.6 V$), whichever is greater < $V_{Bias} < 5.5 V$		0.01		%/V
Dropout Voltage	V_{DO}	$I_{OUT}=500mA$		90		mV
Ripple Rejection	$PSRR_{(VIN)}$	V_{IN} to V_{OUT} , $f = 1 kHz$, $I_{OUT} = 150mA$, $V_{IN} \geq V_{OUT} + 0.5 V$		70		dB
	$PSRR_{(VBias)}$	V_{Bias} to V_{OUT} , $f = 1 kHz$, $I_{OUT} = 150mA$, $V_{IN} \geq V_{OUT} + 0.5 V$		70		dB
Output Voltage Temperature Coefficient	$\frac{\Delta V_{OUT}}{\Delta T}$	$I_{OUT}=100mA$ $-40^\circ C \leq T \leq 85^\circ C$		± 100		ppm/ $^\circ C$
Output Noise Voltage	V_N	$V_{IN}=V_{OUT}+0.5V$, $V_{OUT}=1V$, $f=10Hz$ to 100kHz		40		μV_{RMS}
Discharge Resistor	$R_{Discharge}$			130		Ω
EN Rising Threshold	V_{ENH}		1.0			V
EN Falling Threshold	V_{ENL}				0.4	V
Thermal Shutdown Temperature	T_{SD}			150		$^\circ C$
Thermal Shutdown Hysteresis	T_{HYS}			20		$^\circ C$

Note 1: Stresses beyond the “Absolute Maximum Ratings” may cause permanent damage to the device. These are stress ratings only. Functional operation of the device at these or any other conditions beyond those indicated in the operational sections of the specification is not implied. Exposure to absolute maximum rating conditions for extended periods may affect device reliability.

Note 2: θ_{JA} of SY20733BSCC is measured in the natural convection at $T_A = 25^\circ C$ on a two-layer Silergy evaluation board. θ_{JC} measurement. Paddle of DFN 1.2x1.2-6 package is the case position for SY20733BSCC.

Note 3: The device is not guaranteed to function outside its operating conditions.

Typical Performance Characteristics

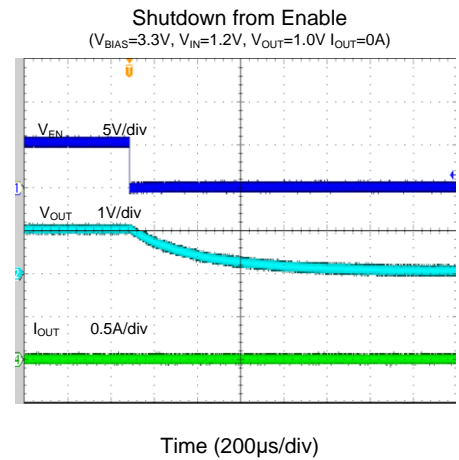
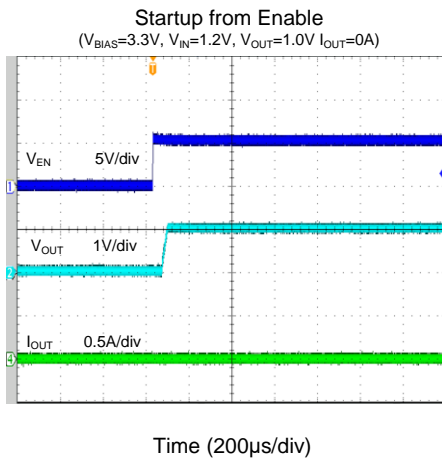
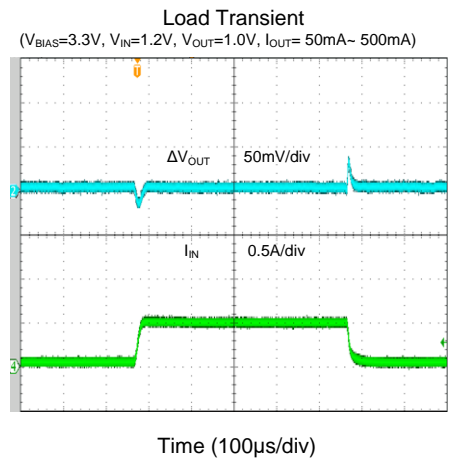
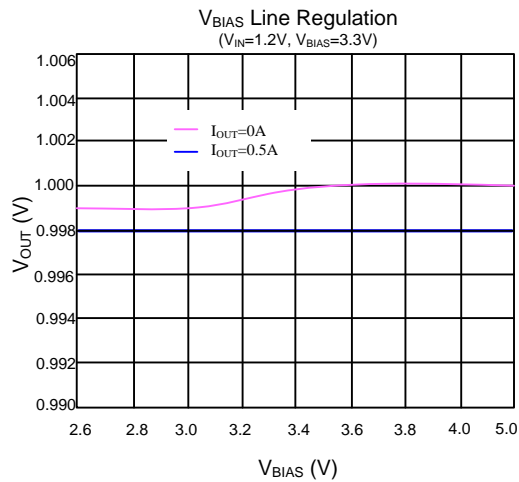
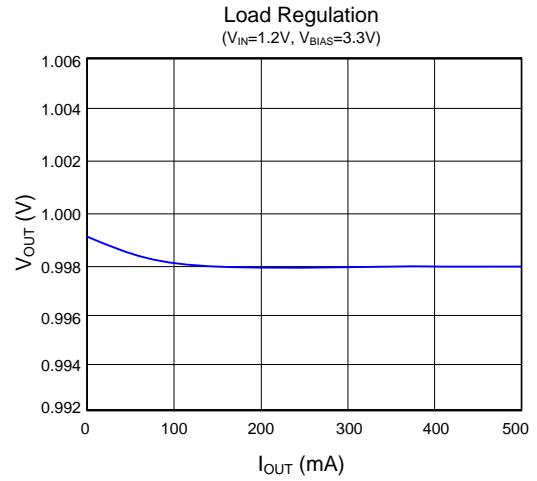
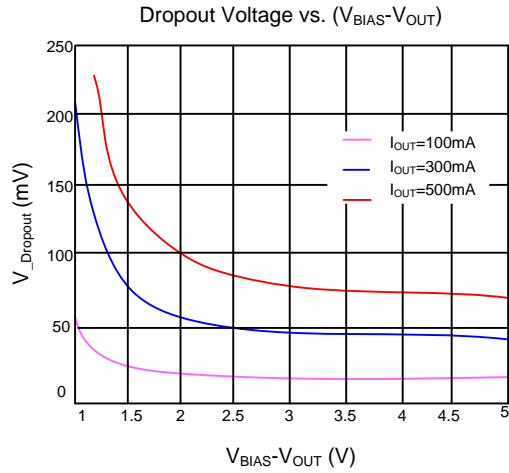

Startup from Enable
 ($V_{BIAS}=3.3V$, $V_{IN}=1.2V$, $V_{OUT}=1.0V$ $I_{OUT}=500mA$)

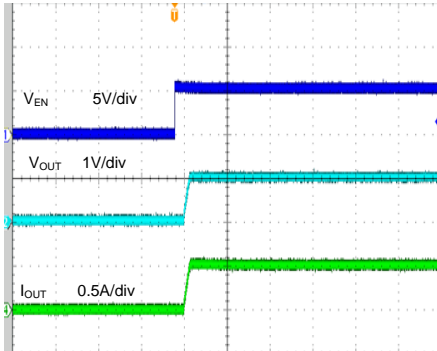

Time (200 μ s/div)

Shutdown from Enable
 ($V_{BIAS}=3.3V$, $V_{IN}=1.2V$, $V_{OUT}=1.0V$ $I_{OUT}=500mA$)

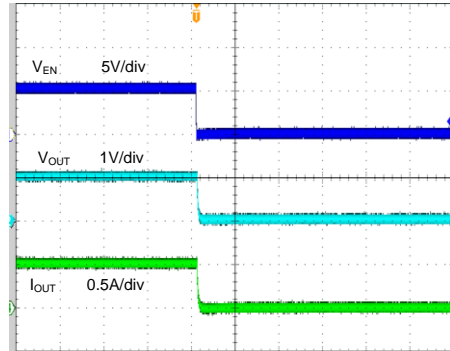

Time (200 μ s/div)

Startup from V_{BIAS}
 ($V_{BIAS}=3.3V$, $V_{IN}=1.2V$, $V_{OUT}=1.0V$ $I_{OUT}=0A$)

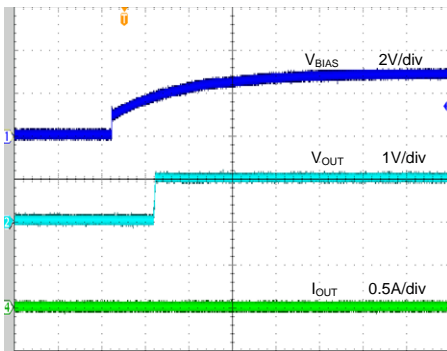

Time (2ms/div)

Shutdown from V_{BIAS}
 ($V_{BIAS}=3.3V$, $V_{IN}=1.2V$, $V_{OUT}=1.0V$ $I_{OUT}=0A$)

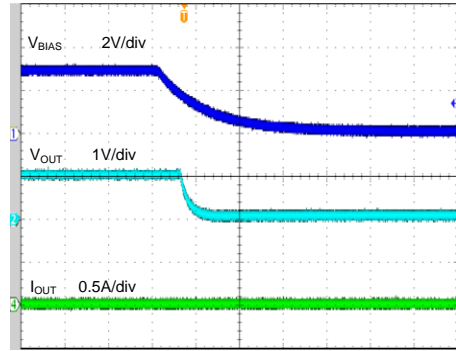

Time (2ms/div)

Startup from V_{BIAS}
 ($V_{BIAS}=3.3V$, $V_{IN}=1.2V$, $V_{OUT}=1.0V$ $I_{OUT}=500mA$)

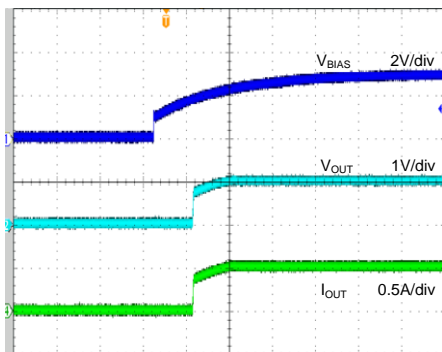

Time (2ms/div)

Shutdown from V_{BIAS}
 ($V_{BIAS}=3.3V$, $V_{IN}=1.2V$, $V_{OUT}=1.0V$ $I_{OUT}=500mA$)

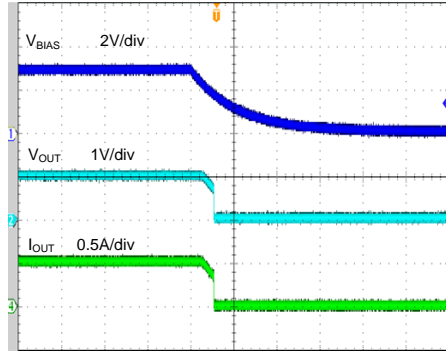

Time (2ms/div)

Startup from V_{IN}
($V_{BIAS}=3.3V$, $V_{IN}=1.2V$, $V_{OUT}=1.0V$ $I_{OUT}=0A$)

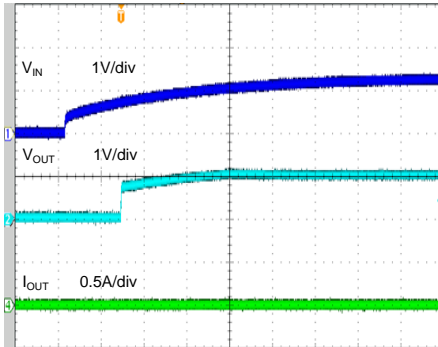

Time (800us/div)

Shutdown from V_{IN}
($V_{BIAS}=3.3V$, $V_{IN}=1.2V$, $V_{OUT}=1.0V$ $I_{OUT}=0A$)

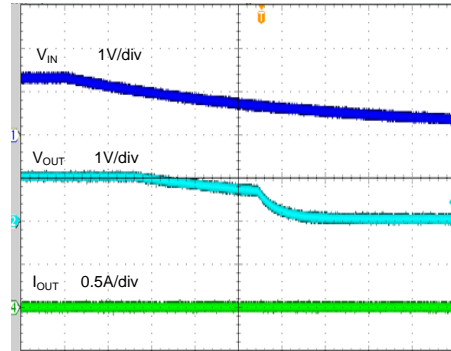

Time (800us/div)

Startup from V_{IN}
($V_{BIAS}=3.3V$, $V_{IN}=1.2V$, $V_{OUT}=1.0V$ $I_{OUT}=500mA$)

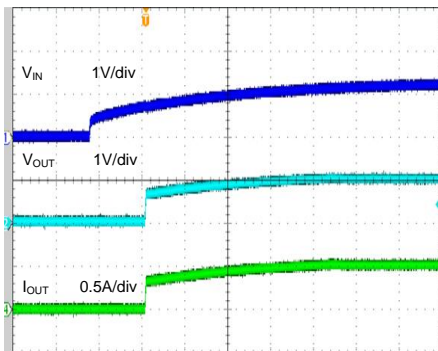

Time (800us/div)

Shutdown from V_{IN}
($V_{BIAS}=3.3V$, $V_{IN}=1.2V$, $V_{OUT}=1.0V$ $I_{OUT}=500mA$)

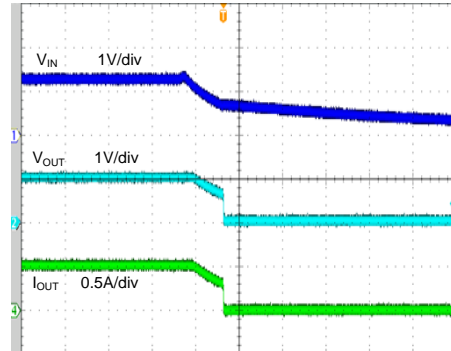

Time (800us/div)

Hard Short Protection
($V_{BIAS}=3.3V$, $V_{IN}=1.2V$, $V_{OUT}=1.0V$ $I_{OUT}=0A$ to short)

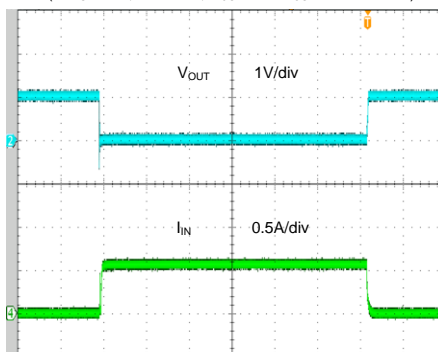

Time (800us/div)

Hard Short Protection
($V_{BIAS}=3.3V$, $V_{IN}=1.2V$, $V_{OUT}=1.0V$ $I_{OUT}=0.5A$ to short)

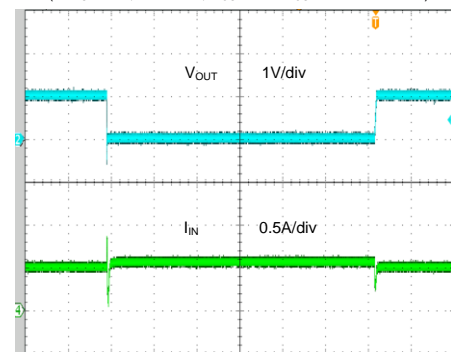

Time (800us/div)

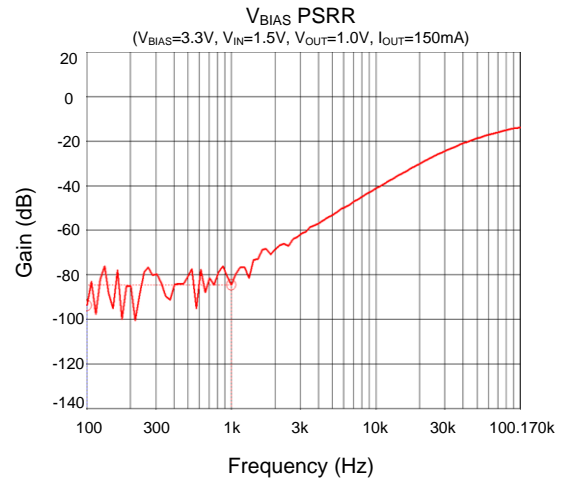
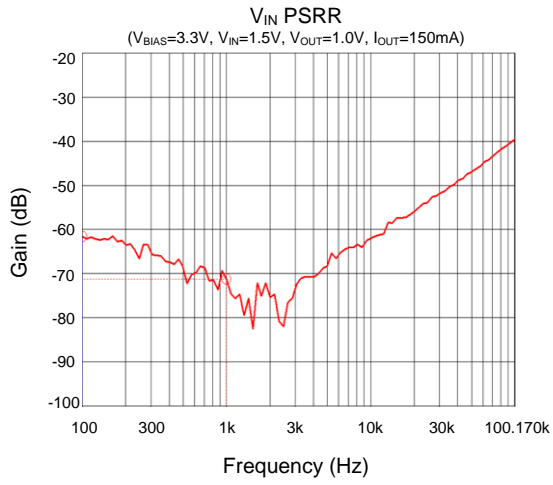

Application Information

The SY20733B is a low dropout LDO regulator with a compact DFN1.2x1.2-6 package, capable of delivering up to 500mA output current.

Input Capacitor C_{IN} :

A 1 μ F decoupling capacitor is recommended between the input and ground pins. A typical X5R or better grade ceramic capacitor with a 6V rating is recommended for most applications.

Output Capacitor C_{OUT} :

The SY20733B is designed to operate using low equivalent series resistance (ESR) ceramic capacitors. This forms a zero to provide phase lead which is required for loop stability. A 2.2 μ F input capacitor with 10m Ω to 50m Ω ESR range can be used in this application. Higher capacitance values help to improve transient response.

Place the input and output capacitors as close as practical to the input and output pins to ensure stable operation.

Bias Capacitor C_{Bias} :

A 0.1 μ F decoupling capacitor is recommended between the bias and GND pins. Place the capacitor as close as practical to the device to achieve the best decoupling performance.

No Load Stability:

The device will remain stable and in regulation with no external load. This is especially important in CMOS RAM keep-alive applications.

Dropout Voltage:

Keep V_{Bias} higher than $V_{OUT} + 1.4V$. Decrease V_{IN} until V_{OUT} starts to decrease. The value for $V_{IN}-V_{OUT}$ is defined as V_{IN} dropout voltage. The V_{IN} dropout voltage is the regulator's minimum $V_{IN}-V_{OUT}$:

$$V_{DROPOUT} = V_{IN} - V_{OUT} = R_{DS(ON)} \times I_{OUT}$$

Current Limit:

The internal current-limit circuit protects the LDO against transient high-load current faults. During an overload event, the minimum current limit is 500mA.

Short-Circuit Protection:

The current through the device increases very rapidly during a short circuit event. When a short circuit is detected by comparing the current through the device with the current limit threshold, the current is reduced to approximately 0.5A. Operating in current limit can trigger the integrated thermal shutdown protection circuit. The output turns on and off when thermal shutdown is reached until the temperature drops below $T_{SD} - T_{HYS}$.

Thermal Considerations:

The SY20733B can source a current of up to 500mA over the full operating junction temperature range. However, the maximum output current must be derated at a higher ambient temperature to limit junction temperature to a maximum of 125°C. The junction temperature must be within the operating range specified under all operating conditions. The LDO power dissipation depends on the input-to-output voltage difference and load current.

The dissipated power, P_D , can be calculated using the following equation:

$$P_D = (V_{IN} - V_{OUT}) I_{OUT}$$

The operating junction temperature can be estimated by using the following formula:

$$P_{DMAX} = (T_{J(MAX)} - T_A) / \theta_{JA}$$

Where $T_{J(MAX)}$ is the maximum junction temperature of die (125°C) and T_A is the maximum ambient temperature.

PCB Layout Guide

Good board layout practices must be used for stable operation, and a large PCB copper area can improve the thermal performance. The input and output capacitors must be directly connected to the device's input, output and ground pins using traces with no other currents flowing through them. Place C_{IN} and C_{OUT} near the device with short traces to the IN, OUT, and ground pins.

Below is the recommended PCB layout example:

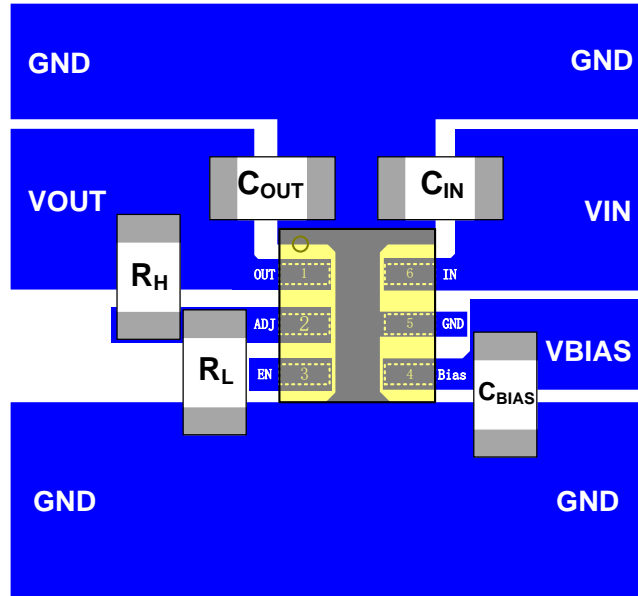
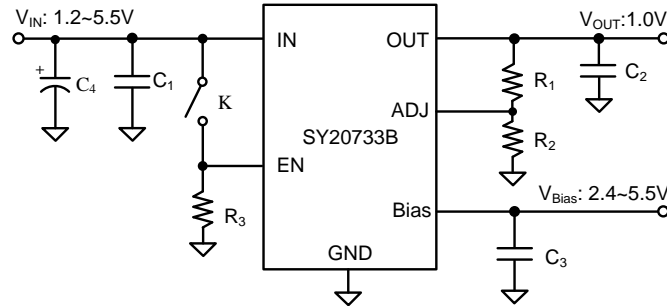

Figure 4. PCB Layout Example

Application Schematic ($V_{OUT} = 1.0V$)



BOM List

Reference Designator	Description	Part Number	Manufacturer
C ₁	1.0 μ F/25V, 0603, X5R	C1608X5R1E105K	TDK
C ₂	2.2 μ F/16V, 0603, X5R	C1608X5R1C225K	TDK
C ₃	0.1 μ F/50V, 0603, X5R	C1608X5R1H104K	TDK
C ₄	100 μ F/16V (electrolytic capacitor)		
R ₁	49.9k Ω , 1%, 0603		
R ₂	200k Ω , 1%, 0603		
R ₃	1M Ω , 0603		

DFN1.2x1.2-6 Package Outline Drawing

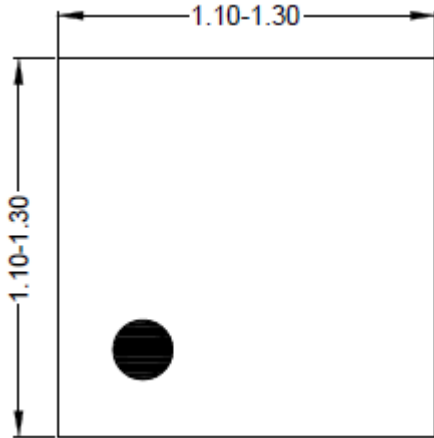

Top View

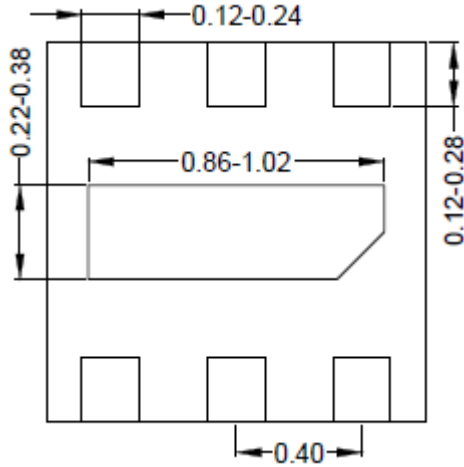

Bottom View

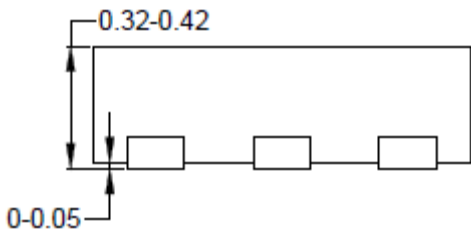

Side View

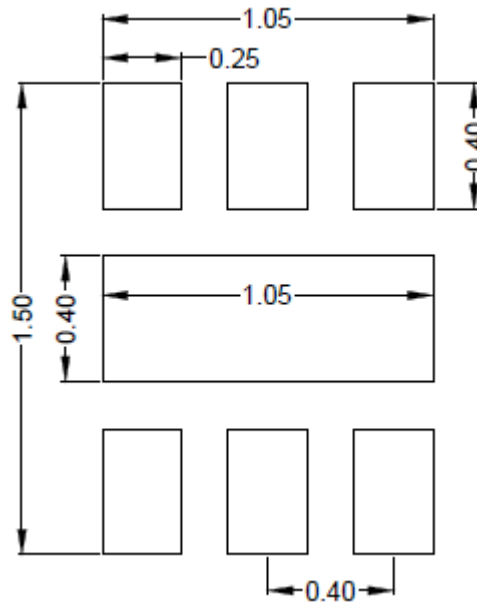

**Recommended PCB Layout
(Reference Only)**

Note: All dimensions are in millimeters and exclude mold flash and metal burr.

Taping & Reel Specification

1. DFN1.2x1.2 Taping Orientation

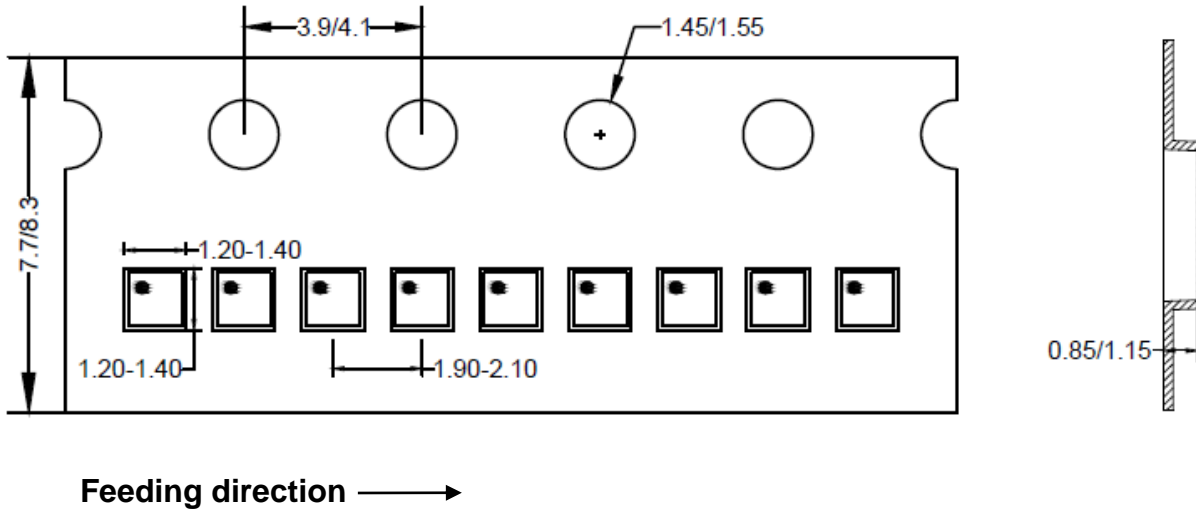

2. Carrier Tape & Reel Specification for Packages

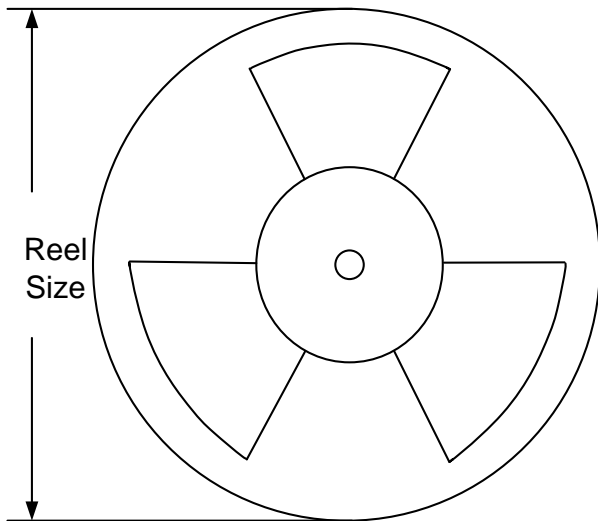

Package type	Tape width (mm)	Pocket pitch(mm)	Reel size (Inch)	Trailer length(mm)	Leader length (mm)	Qty per reel
DFN1.2x1.2	8	2	7"	400	160	5000

3. Others: NA



Revision History

The revision history provided is for informational purposes only and is believed to be accurate; however, it is not warranted. Please reference the latest revision.

Date	Revision	Change
Sep. 25, 2023	Revision 1.0	Language improvements for clarity.
Mar. 21, 2019	Revision 0.9B	Qty per reel change from 10000 to 5000
Mar. 20, 2018	Revision 0.9A	1. Update in "Absolute Maximum Ratings" a. Change from "All pins ----- 6.0V" to "IN, OUT, Bias, EN, ADJ ----- -0.3V to 6.0V". b. Change from "Junction Temperature Range ----- 150°C" to "Junction Temperature Range ----- -40°C to 150°C". 2. Update in "Recommended Operating Conditions" Add "IN ----- 0.8V to 5.5V OUT ----- 0.8V to V _{Bias} -1.4V". 3. Update in "Dropout Voltage" in Page9 Change from "When V _{Bias} is high enough" to "Keep V _{Bias} is higher than V _{OUT} +1.4V".
Apr. 25, 2017	Revision 0.9	Initial Release



IMPORTANT NOTICE

1. **Right to make changes.** Silergy and its subsidiaries (hereafter Silergy) reserve the right to change any information published in this document, including but not limited to circuitry, specification and/or product design, manufacturing or descriptions, at any time and without notice. This document supersedes and replaces all information supplied prior to the publication hereof. Buyers should obtain the latest relevant information before placing orders and should verify that such information is current and complete. All semiconductor products are sold subject to Silergy's standard terms and conditions of sale.

2. **Applications.** Application examples that are described herein for any of these products are for illustrative purposes only. Silergy makes no representation or warranty that such applications will be suitable for the specified use without further testing or modification. Buyers are responsible for the design and operation of their applications and products using Silergy products. Silergy or its subsidiaries assume no liability for any application assistance or designs of customer products. It is customer's sole responsibility to determine whether the Silergy product is suitable and fit for the customer's applications and products planned. To minimize the risks associated with customer's products and applications, customer should provide adequate design and operating safeguards. Customer represents and agrees that it has all the necessary expertise to create and implement safeguards which anticipate dangerous consequences of failures, monitor failures and their consequences, lessen the likelihood of failures that might cause harm and take appropriate remedial actions. Silergy assumes no liability related to any default, damage, costs or problem in the customer's applications or products, or the application or use by customer's third-party buyers. Customer will fully indemnify Silergy, its subsidiaries, and their representatives against any damages arising out of the use of any Silergy components in safety-critical applications. It is also buyers' sole responsibility to warrant and guarantee that any intellectual property rights of a third party are not infringed upon when integrating Silergy products into any application. Silergy assumes no responsibility for any said applications or for any use of any circuitry other than circuitry entirely embodied in a Silergy product.

3. **Limited warranty and liability.** Information furnished by Silergy in this document is believed to be accurate and reliable. However, Silergy makes no representation or warranty, expressed or implied, as to the accuracy or completeness of such information and shall have no liability for the consequences of use of such information. In no event shall Silergy be liable for any indirect, incidental, punitive, special or consequential damages, including but not limited to lost profits, lost savings, business interruption, costs related to the removal or replacement of any products or rework charges, whether or not such damages are based on tort or negligence, warranty, breach of contract or any other legal theory. Notwithstanding any damages that customer might incur for any reason whatsoever, Silergy' aggregate and cumulative liability towards customer for the products described herein shall be limited in accordance with the Standard Terms and Conditions of Sale of Silergy.

4. **Suitability for use.** Customer acknowledges and agrees that it is solely responsible for compliance with all legal, regulatory and safety-related requirements concerning its products, and any use of Silergy components in its applications, notwithstanding any applications-related information or support that may be provided by Silergy. Silergy products are not designed, authorized or warranted to be suitable for use in life support, life-critical or safety-critical systems or equipment, nor in applications where failure or malfunction of a Silergy product can reasonably be expected to result in personal injury, death or severe property or environmental damage. Silergy assumes no liability for inclusion and/or use of Silergy products in such equipment or applications and therefore such inclusion and/or use is at the customer's own risk.

5. **Terms and conditions of commercial sale.** Silergy products are sold subject to the standard terms and conditions of commercial sale, as published at <http://www.silergy.com/stdterms>, unless otherwise agreed in a valid written individual agreement specifically agreed to in writing by an authorized officer of Silergy. In case an individual agreement is concluded only the terms and conditions of the respective agreement shall apply. Silergy hereby expressly objects to and denies the application of any customer's general terms and conditions with regard to the purchase of Silergy products by the customer.

6. **No offer to sell or license.** Nothing in this document may be interpreted or construed as an offer to sell products that is open for acceptance or the grant, conveyance or implication of any license under any copyrights, patents or other industrial or intellectual property rights. Silergy makes no representation or warranty that any license, either express or implied, is granted under any patent right, copyright, mask work right, or other intellectual property right. Information published by Silergy regarding third-party products or services does not constitute a license to use such products or services or a warranty or endorsement thereof. Use of such information may require a license from a third party under the patents or other intellectual property of the third party, or a license from Silergy under the patents or other intellectual property of Silergy.

For more information, please visit: www.silergy.com

© 2019 Silergy Corp.

All Rights Reserved.

X-ON Electronics

Largest Supplier of Electrical and Electronic Components

Click to view similar products for [LDO Voltage Regulators](#) category:

Click to view products by [Silergy](#) manufacturer:

Other Similar products are found below :

[AP7363-SP-13](#) [NCV8664CST33T3G](#) [L79M05TL-E](#) [AP7362-HA-7](#) [PT7M8202B12TA5EX](#) [TCR3DF185,LM\(CT](#) [TLF4949EJ](#)
[NCP4687DH15T1G](#) [NCV8703MX30TCG](#) [LP2951CN](#) [NCV4269CPD50R2G](#) [AP7315-25W5-7](#) [AP2111H-1.2TRG1](#) [ZLDO1117QK50TC](#)
[AZ1117ID-ADJTRG1](#) [NCP114BMX075TCG](#) [MC33269T-3.5G](#) [TLE4471GXT](#) [AP7315-33SA-7](#) [NCV4266-2CST33T3G](#) [NCP715SQ15T2G](#)
[NCV8623MN-50R2G](#) [NCV563SQ18T1G](#) [NCV8664CDT33RKG](#) [NCV4299CD250R2G](#) [NCP715MX30TBG](#) [NCV8702MX25TCG](#)
[L974113TR](#) [TLE7270-2E](#) [NCV562SQ25T1G](#) [AP2202K-2.6TRE1](#) [NCV8170BMX300TCG](#) [NCV8152MX300180TCG](#) [NCP700CMT45TBG](#)
[AP7315-33W5-7](#) [LD56100DPU28R](#) [NCP154MX180300TAG](#) [AP2113AMTR-G1](#) [NJW4104U2-33A-TE1](#) [MP2013AGG-5-P](#)
[NCV8775CDT50RKG](#) [NJM2878F3-45-TE1](#) [S-19214B00A-V5T2U7](#) [S-19214B50A-V5T2U7](#) [S-19213B50A-V5T2U7](#) [S-19214BC0A-](#)
[E8T1U7*1](#) [S-19213B00A-V5T2U7](#) [S-19213B33A-V5T2U7](#) [S-19213BC0A-V5T2U7](#) [S-1313D18-N4T1U4](#)