

General Description

The SY20737H is a high-voltage input Linear Voltage Regulator (LDO) operating with input voltages from 4V to 36V and capable of delivering 500mA to a load, with ultra-low ground current and low dropout voltage.

The SY20737H has an adjustable output that can be configured using two external resistors. The device offers protection features, including an over-current limit, output short and over-temperature protections.

The Enable input allows disabling the part to reduce power consumption.

The High-Power Supply Rejection Ratio (PSRR) and low noise makes this part suitable for many applications in industrial and consumer products.

The SY20737H is available in a compact DFN 2mmx3mm-8pin package.

Features

- Input Voltage Range: 4V to 36V
- $V_{ABS} = 40V$
- $V_{FB}: 1.235V (\pm 1\%)$
- Output Voltage Tolerance: $\pm 1\%$
- Line Regulation: $0.2\%/V$
- Load Regulation: 0.25%
- PSRR: 60dB
- Noise Level: $150\mu VRMS$
- Operating T_J : $-40^\circ C$ to $125^\circ C$
- Auto Retry-During Fault Conditions
- Compact Package: DFN2x3-8

Applications

- Portable Consumer Equipment
- Portable Instrumentation
- Industrial Equipment
- SMPS Post Regulators

Typical Application

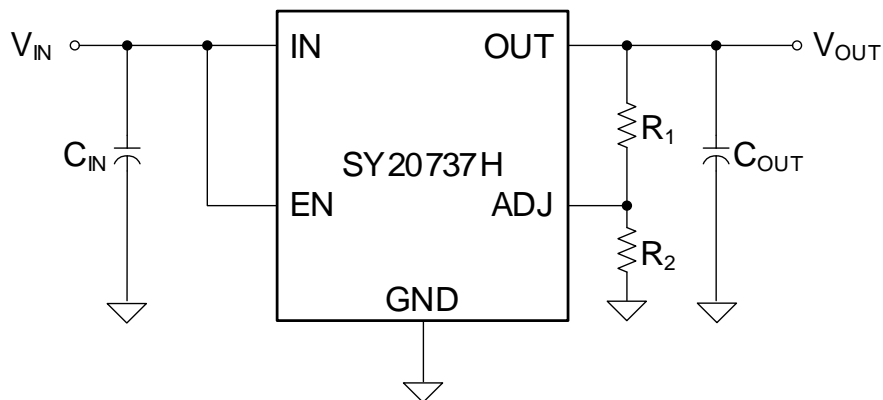

Figure 1. Schematic Diagram



Ordering Information

| Ordering Part Number | Package Type | Top Mark |
|----------------------|---|----------|
| SY20737HDGD | DFN2x3-8 RoHS Compliant and Halogen Free | 4Axyz |

x=year code, y=week code, z=lot number code

Pinout (top view)

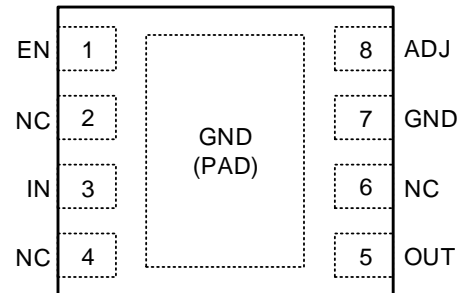

Pin Description

| Pin Name | Pin Number | Pin Description |
|----------|------------|---|
| EN | 1 | Enable. CMOS-compatible control input. Logic high = enable. Logic low or open = shutdown. |
| NC | 2, 4, 6 | No connection. |
| IN | 3 | Supply input. |
| OUT | 5 | Regulator output. |
| GND | 7 | Ground. |
| ADJ | 8 | Adjustable part only. Feedback input. Connect to resistive voltage-divider network. |

Block Diagram

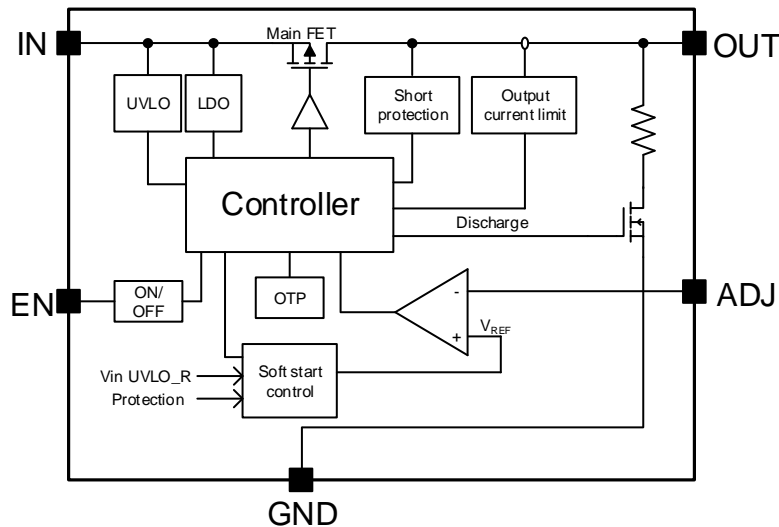

Figure 2. Block Diagram

Absolute Maximum Ratings

| Parameter (Note1) | Min | Max | Unit |
|---------------------------------------|------|-----|------|
| IN, EN, OUT, ADJ | -0.3 | 40 | V |
| Lead Temperature (Soldering, 10 sec.) | | 260 | °C |
| Junction Temperature, Operating | -40 | 150 | |
| Storage Temperature | -65 | 150 | |

Thermal Information

| Parameter (Note2) | Typ | Unit |
|--|------|------|
| θ_{JA} Junction-to-ambient Thermal Resistance | 46 | °C/W |
| θ_{JB} Junction-to-Board Thermal Resistance | 22.5 | |
| θ_{JC} Junction-to-case Thermal Resistance | 28 | |
| P_D Power Dissipation $T_A = 25^\circ\text{C}$ | 2.17 | W |

Recommended Operating Conditions

| Parameter (Note 3) | Min | Max | Unit |
|---------------------------------|-----|-----|------|
| IN | 4 | 36 | V |
| EN, OUT, ADJ | 0 | 36 | |
| Junction Temperature, Operating | -40 | 125 | °C |



Electrical Characteristics

($V_{IN} = V_{EN} = 12V$, $T_J = -40^{\circ}C \sim 125^{\circ}C$, typical values are at $T_J = 25^{\circ}C$, unless otherwise specified, the values are guaranteed by test, design, or statistical correlation.)

| Parameter | Symbol | Test Conditions | Min | Typ | Max | Unit |
|---------------------------------|-------------------|--|-------|-------|-------|---------------|
| Input Voltage | V_{IN} | | 4 | | 36 | V |
| Reference Voltage | V_{REF} | $T_A = 25^{\circ}C$ | 1.223 | 1.235 | 1.247 | V |
| | | $T_J = -40^{\circ}C \sim 125^{\circ}C$ | 1.210 | 1.235 | 1.260 | V |
| Line Regulation | ΔV_{LNR} | $I_{OUT} = 10mA$, $4V \leq V_{IN} \leq 36V$ | | 1 | 1.5 | mV/V |
| Load Regulation | ΔV_{LDR} | $V_{IN} = 5V$, $10mA \leq I_{OUT} \leq 0.5A$, | | 0.25 | 1.0 | % |
| Dropout Voltage | ΔV_{DROP} | $I_{OUT} = 10mA$ | | 10 | 20 | mV |
| | | $I_{OUT} = 300mA$ | | 300 | 540 | mV |
| | | $I_{OUT} = 500mA$ | | 500 | 750 | mV |
| Shutdown Current | I_{SHDN} | $V_{EN} = 0V$, $V_{IN} = 24V$ | | | 5 | μA |
| Ground Pin Current | I_{GND} | No Load | | 7 | 14 | μA |
| | | $I_L = 0.1mA$ | | 90 | 190 | μA |
| | | $I_L = 50mA$ | | 250 | 900 | μA |
| | | $I_L = 150mA$ | | 1.0 | 2.5 | mA |
| | | $I_L = 500mA$ | | 6.5 | 30.0 | mA |
| Output Current | I_O | $V_{IN} = V_{OUT} + 1V$ | 0 | | 500 | mA |
| Current Limit | I_{LIMIT} | $V_{OUT} = 0.9 \times V_{OUT}(\text{normal})$ | 600 | 900 | 1200 | mA |
| Input Voltage UVLO Threshold | V_{UVLO} | V_{IN} rising | | | 3.9 | V |
| UVLO Hysteresis | $V_{UVLO,HYS}$ | | | 200 | | mV |
| Shutdown Discharge Resistance | R_{DIS} | | | 600 | | Ω |
| Ripple Rejection | PSRR | | | 60 | | dB |
| Output Noise | e_{NO} | $I_L = 10mA$, $C_L = 1.0\mu F$, $C_{IN} = 1\mu F$, (10Hz – 100kHz) | | 150 | | μV_{RMS} |
| Enable Input Logic-low Voltage | V_{IL} | OFF | | | 0.4 | V |
| Enable Input Logic-high Voltage | V_{IH} | ON | 1.5 | | | V |
| Thermal Shutdown Temperature | T_{SD} | | | 150 | | $^{\circ}C$ |
| Thermal Shutdown Hysteresis | T_{HYS} | | | 20 | | $^{\circ}C$ |

Note 1: Stresses beyond the “Absolute Maximum Ratings” may cause permanent damage to the device. These are stress ratings only. Functional operation of the device at these or any other conditions beyond those indicated in the operational sections of the specification is not implied. Exposure to absolute maximum rating conditions for extended periods may affect device reliability.

Note 2: θ_{JA} is measured in the natural convection at $T_A = 25^{\circ}C$ on a high effective single layer thermal conductivity test board of JESD51-2, -5, -7, -8, -14 thermal measurement standard.

Note 3: The device is not guaranteed to function outside its operating conditions.

Typical Performance Characteristics

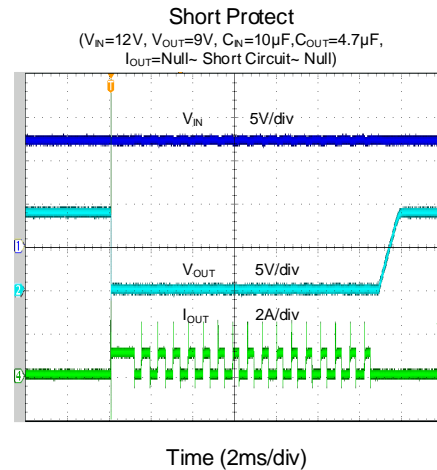
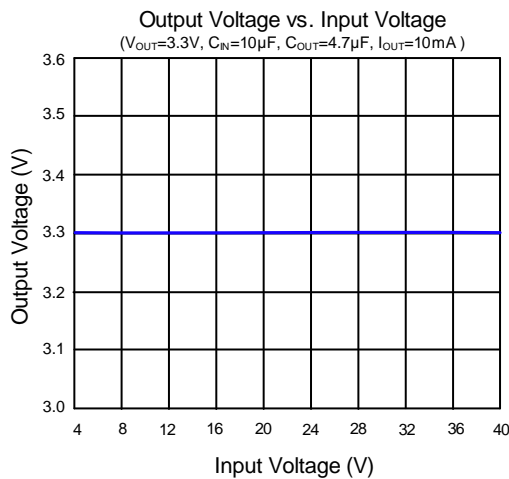
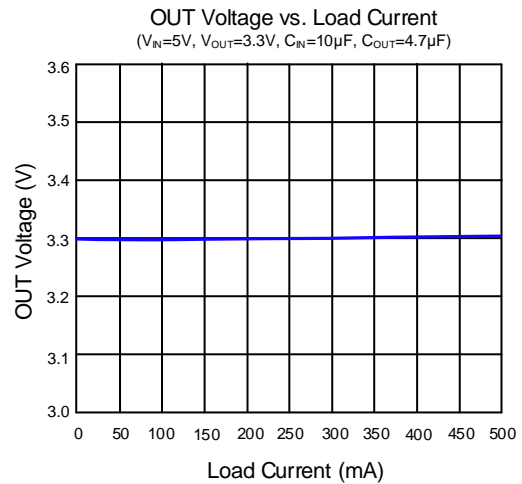
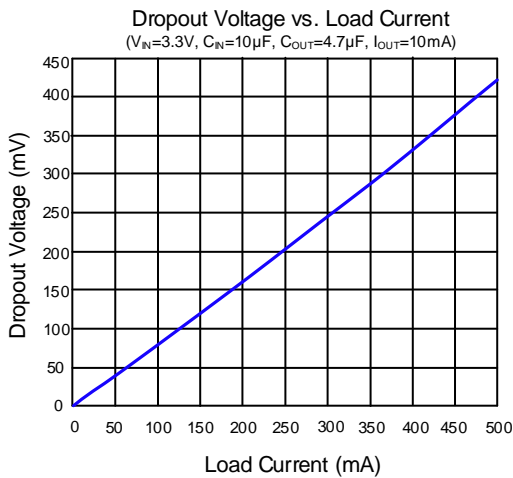
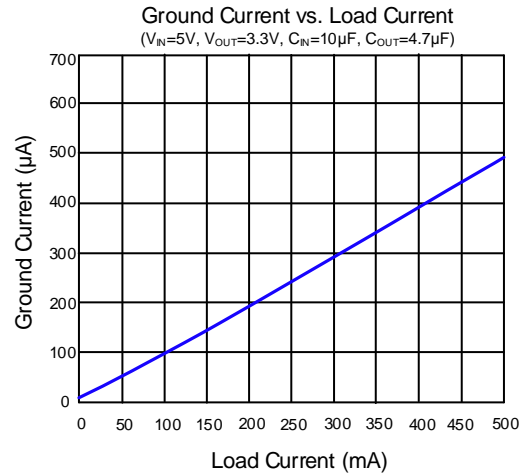
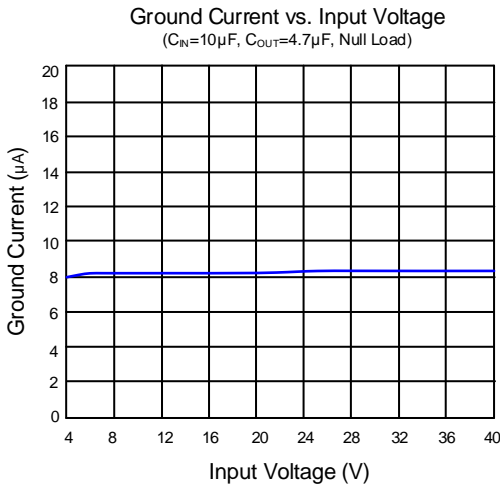

Startup from Enable

($V_{IN}=5V$, $V_{OUT}=3.3V$, $C_N=10\mu F$, $C_{OUT}=4.7\mu F$, $I_{OUT}=500mA$)

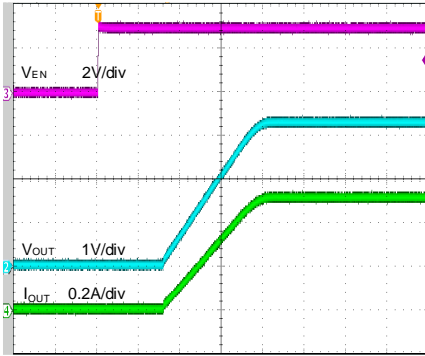

Time (400µs/div)

Shutdown from Enable

($V_{IN}=5V$, $V_{OUT}=3.3V$, $C_N=10\mu F$, $C_{OUT}=4.7\mu F$, $I_{OUT}=500mA$)

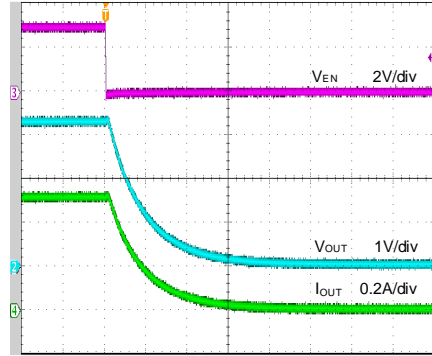

Time (40µs/div)

Startup from V_{IN}

($V_{IN}=5V$, $V_{OUT}=3.3V$, $C_N=10\mu F$, $C_{OUT}=4.7\mu F$, $I_{OUT}=500mA$)

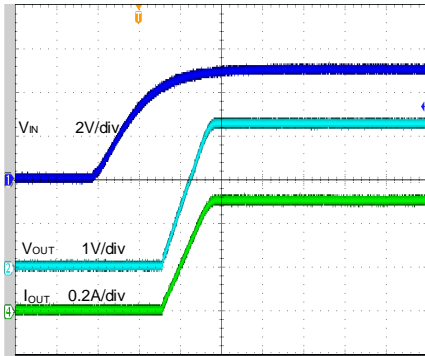

Time (800µs/div)

Shutdown from V_{IN}

($V_{IN}=5V$, $V_{OUT}=3.3V$, $C_N=10\mu F$, $C_{OUT}=4.7\mu F$, $I_{OUT}=500mA$)

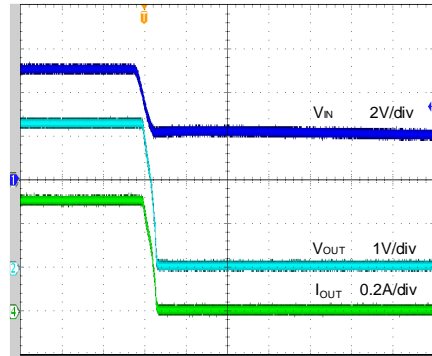

Time (2ms/div)

Load Transient

($V_{IN}=5V$, $V_{OUT}=3.3V$, $C_N=10\mu F$, $C_{OUT}=4.7\mu F$, $I_{OUT}=10mA \sim 500mA \sim 10mA$)

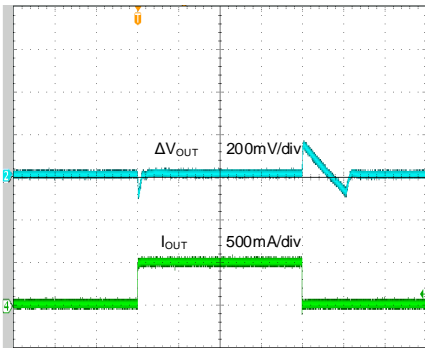

Time (100µs/div)

Line Transient

($V_{IN}=5V \sim 12V \sim 5V$, $V_{OUT}=3.3V$, $C_N=10\mu F$, $C_{OUT}=4.7\mu F$, $I_{OUT}=500mA$)

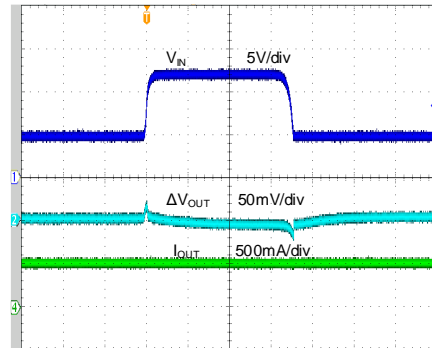

Time (2ms/div)

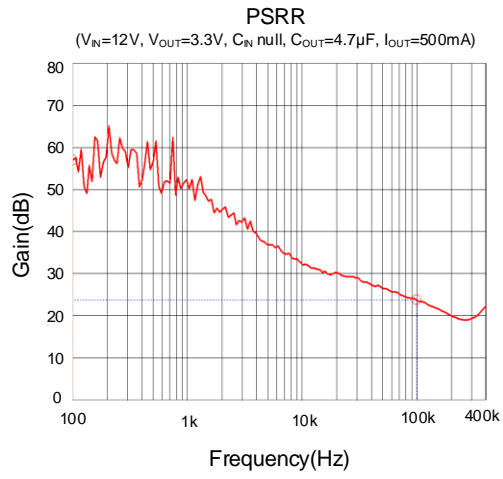

Application Information

The SY20737H is a 500mA high-current capacity linear regulator with ultra-low ground current and low dropout voltage. The SY20737H has an adjustable output that can be set by two external resistors. The device provides protection features, including over-current limit, output short and over-temperature protections.

Feedback Resistor Dividers R₁ and R₂:

Choose R₁ and R₂ to program the proper output voltage. To minimize the power consumption under light loads, choosing large resistance values for both R₁ and R₂ is recommended. A value of between 10kΩ and 10MΩ is recommended for both resistors. As an example, for a V_{OUT} of 3.3V, if R₁=50.1kΩ is chosen, then using the following equation, R₂ can be calculated to be 30kΩ:

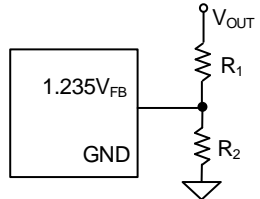
$$R_2 = \frac{1.235V}{V_{OUT} - 1.235V} \times R_1$$

Input Capacitor C_{IN}:

An input capacitor of about 10μF between the device input and ground pin is required. A typical X5R or better grade ceramic capacitor is recommended for most applications. Place the input capacitor as close as practical to the device to minimize the input noise.

Output Capacitor C_{OUT}:

The SY20737H is designed specifically to work with very small ceramic output capacitors for transient stability. A 4.7μF output capacitance can be used in this application. Higher capacitance values help to improve transient response. The output capacitor's ESR is critical because it forms a zero to provide phase lead which is required for loop stability.

Dropout Voltage:

The SY20737H has a very low dropout voltage due to its extra low R_{DS(ON)} of the main PMOS, which determines the lowest usable supply.

$$V_{DROPOUT} = V_{IN} - V_{OUT} = R_{DS(ON)} \times I_{OUT}$$

Over-Current and Short-Circuit Protection:

The device includes over-current and short-circuit protection. The current limiting circuit regulates the output current to its limit threshold to protect the device from damage. Under over-current or short-circuit conditions, the dissipated power on device can be high, which may trigger thermal protection.

Thermal Considerations:

The SY20737H can deliver a current of up to 500mA over the full operating temperature range. However, the maximum output current must be derated at a higher ambient temperature. Under all operating conditions the junction temperature must be within the range specified. The LDO power dissipation can be calculated based on the output current and the voltage drop across the regulator.

The dissipated power, P_D, can be calculated using the following equation:

$$P_D = (V_{IN} - V_{OUT}) \times I_{OUT} + V_{IN} \times I_{GND}$$

The operating junction temperature can be estimated by the following thermal formula:

$$P_{D(MAX)} = (T_{J(MAX)} - T_A) / \theta_{JA}$$

Where T_{J(MAX)} is the maximum junction temperature of die (125°C), T_A is the maximum ambient temperature and θ_{JA} is the junction to ambient thermal resistance for the package (46°C/W).

Load Transient Considerations:

The SY20737H integrates the compensation components to achieve stability and fast transient response. In some applications, adding a small ceramic capacitor in parallel with R₁ may further speed up the load transient responses and is thus recommended for applications with large load transient step requirements.

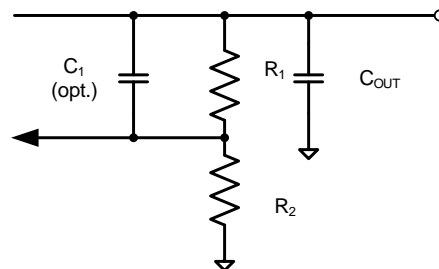

PCB Layout Guide:

For the best performance of the SY20737H, the following guidelines must be followed:

1. Keep all power traces as short and wide as possible. A 2-layer- or 4-layer board is recommended for improved thermal performance and current flow capability.
2. Place the input/output capacitor close to the IC for better transient performance.
3. Maximize the copper area connected to GND and the exposed pad of the package to improve heat dissipation.

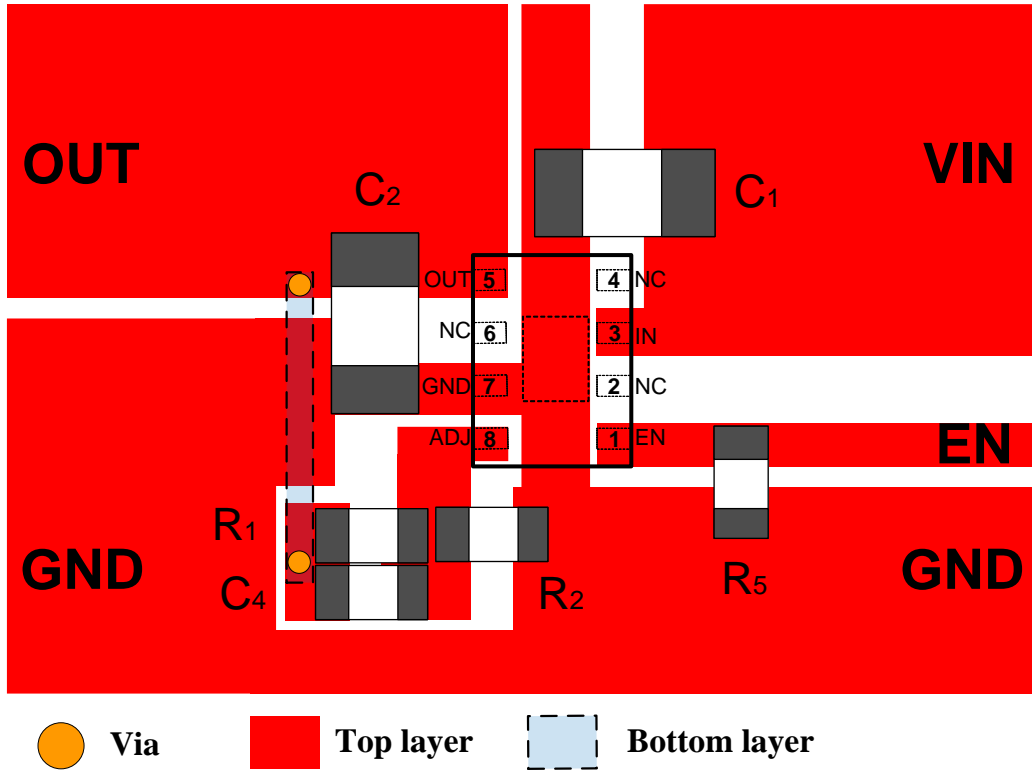
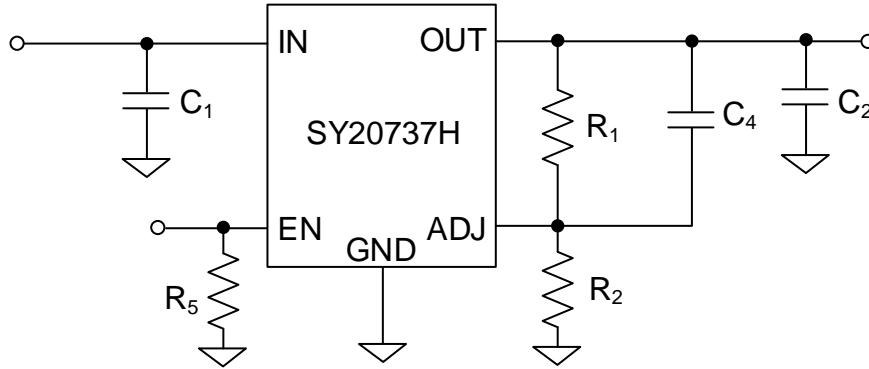

Figure 3. PCB Layout Suggestion

Application Schematic (V_{OUT}=3.3V)



BOM List

| Reference Designator | Description | Part Number | Manufacturer |
|----------------------|--------------------|----------------|--------------|
| C ₁ | 10μF/50V/X5R,1206 | GRM31CR61H106K | Murata |
| C ₂ | 4.7μF/25V/X5R,1206 | GRM31CR61E475K | Murata |
| R ₁ | 50.1kΩ, 1%, 0603 | | |
| R ₂ | 30kΩ, 1%, 0603 | | |
| R ₅ | 1MΩ, 1%, 0603 | | |

DFN2x3-8 Package Outline

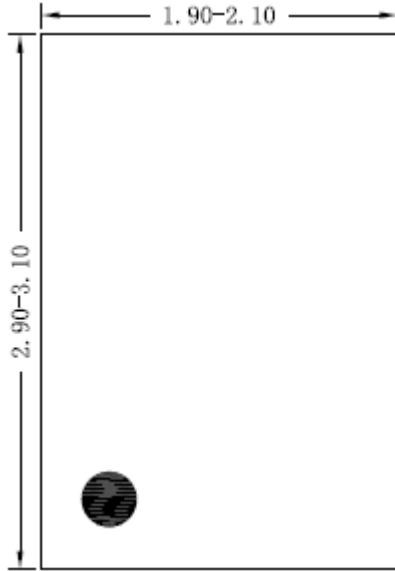

Top View

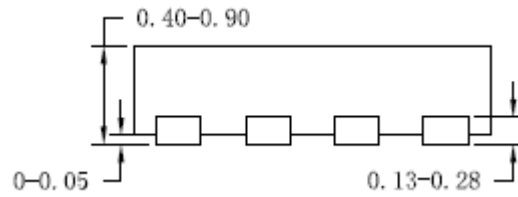

Side View

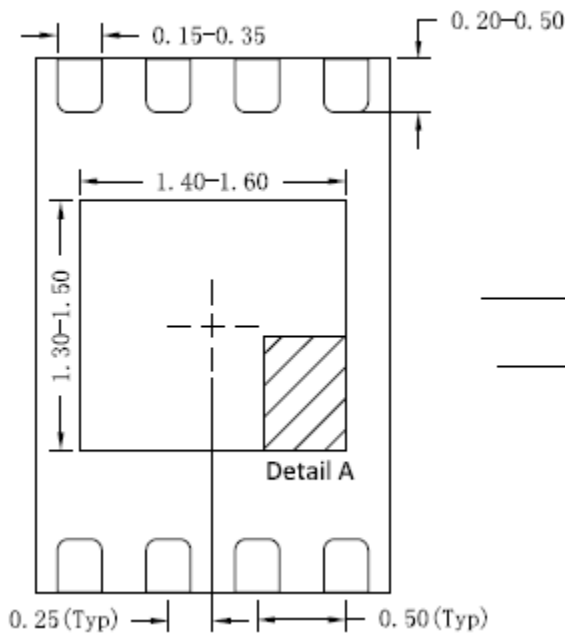

Bottom View

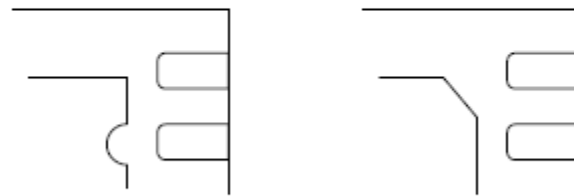

Detail A

Pin1 Identifier: two options

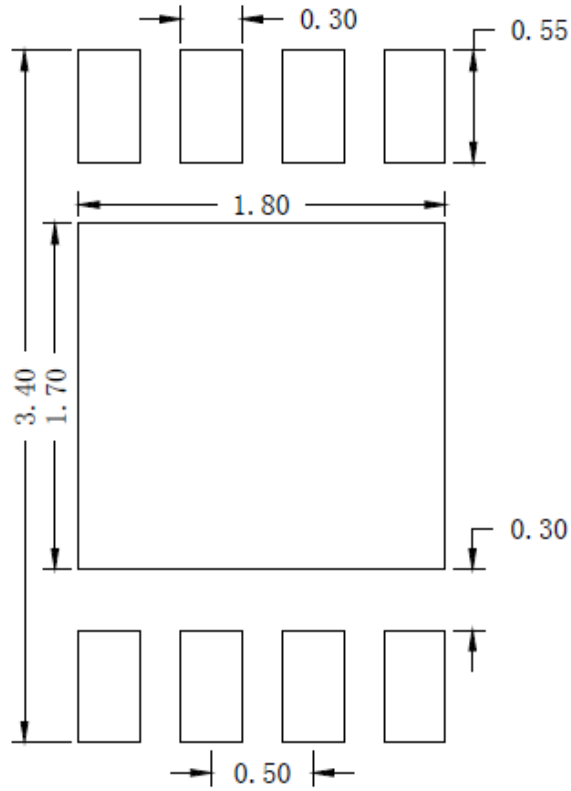

**Recommended PCB Layout
(Reference Only)**

Note: All dimensions are in millimeters and exclude mold flash and metal burr.

Taping & Reel Specification

1. DFN2x3-8 Taping Orientation

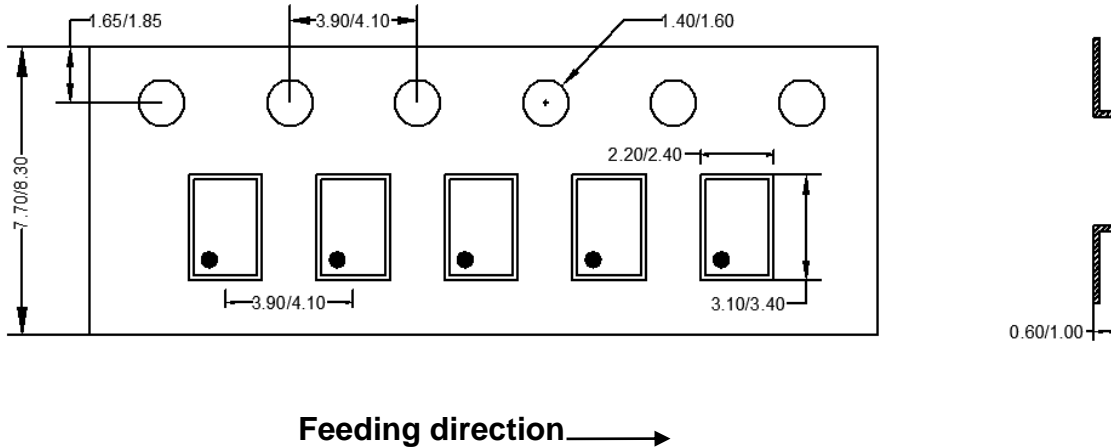

2. Carrier Tape & Reel Specification for Packages

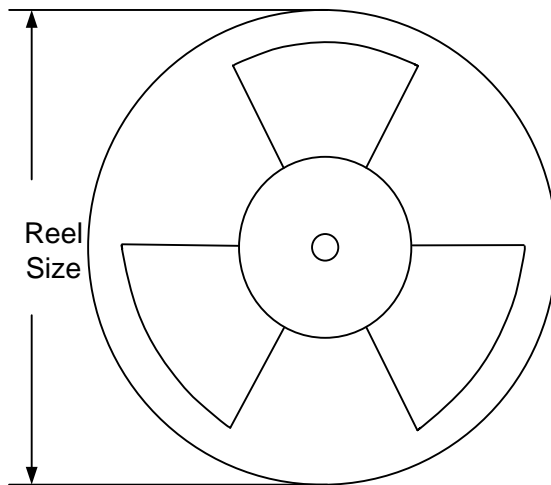

| Package type | Tape width (mm) | Pocket pitch(mm) | Reel size (Inch) | Trailer length(mm) | Leader length (mm) | Qty per reel |
|--------------|-----------------|------------------|------------------|--------------------|--------------------|--------------|
| DFN2x3 | 8 | 4 | 7" | 400 | 160 | 3000 |

3. Others: NA



Revision History

The revision history provided is for informational purposes only and is believed to be accurate; however, it is not warranted. Please reference the latest revision.

| Date | Revision | Change |
|--------------|-----------------|------------------------------------|
| Sep.27, 2023 | Revision 1.0 | Language improvements for clarity. |
| Jul.28, 2020 | Revision 0.9 | Initial Release |

IMPORTANT NOTICE

1. **Right to make changes.** Silergy and its subsidiaries (hereafter Silergy) reserve the right to change any information published in this document, including but not limited to circuitry, specification and/or product design, manufacturing or descriptions, at any time and without notice. This document supersedes and replaces all information supplied prior to the publication hereof. Buyers should obtain the latest relevant information before placing orders and should verify that such information is current and complete. All semiconductor products are sold subject to Silergy's standard terms and conditions of sale.
2. **Applications.** Application examples that are described herein for any of these products are for illustrative purposes only. Silergy makes no representation or warranty that such applications will be suitable for the specified use without further testing or modification. Buyers are responsible for the design and operation of their applications and products using Silergy products. Silergy or its subsidiaries assume no liability for any application assistance or designs of customer products. It is customer's sole responsibility to determine whether the Silergy product is suitable and fit for the customer's applications and products planned. To minimize the risks associated with customer's products and applications, customer should provide adequate design and operating safeguards. Customer represents and agrees that it has all the necessary expertise to create and implement safeguards which anticipate dangerous consequences of failures, monitor failures and their consequences, lessen the likelihood of failures that might cause harm and take appropriate remedial actions. Silergy assumes no liability related to any default, damage, costs or problem in the customer's applications or products, or the application or use by customer's third-party buyers. Customer will fully indemnify Silergy, its subsidiaries, and their representatives against any damages arising out of the use of any Silergy components in safety-critical applications. It is also buyers' sole responsibility to warrant and guarantee that any intellectual property rights of a third party are not infringed upon when integrating Silergy products into any application. Silergy assumes no responsibility for any said applications or for any use of any circuitry other than circuitry entirely embodied in a Silergy product.
3. **Limited warranty and liability.** Information furnished by Silergy in this document is believed to be accurate and reliable. However, Silergy makes no representation or warranty, expressed or implied, as to the accuracy or completeness of such information and shall have no liability for the consequences of use of such information. In no event shall Silergy be liable for any indirect, incidental, punitive, special or consequential damages, including but not limited to lost profits, lost savings, business interruption, costs related to the removal or replacement of any products or rework charges, whether or not such damages are based on tort or negligence, warranty, breach of contract or any other legal theory. Notwithstanding any damages that customer might incur for any reason whatsoever, Silergy' aggregate and cumulative liability towards customer for the products described herein shall be limited in accordance with the Standard Terms and Conditions of Sale of Silergy.
4. **Suitability for use.** Customer acknowledges and agrees that it is solely responsible for compliance with all legal, regulatory and safety-related requirements concerning its products, and any use of Silergy components in its applications, notwithstanding any applications-related information or support that may be provided by Silergy. Silergy products are not designed, authorized or warranted to be suitable for use in life support, life-critical or safety-critical systems or equipment, nor in applications where failure or malfunction of an Silergy product can reasonably be expected to result in personal injury, death or severe property or environmental damage. Silergy assumes no liability for inclusion and/or use of Silergy products in such equipment or applications and therefore such inclusion and/or use is at the customer's own risk.
5. **Terms and conditions of commercial sale.** Silergy products are sold subject to the standard terms and conditions of commercial sale, as published at <http://www.silergy.com/stdterms>, unless otherwise agreed in a valid written individual agreement specifically agreed to in writing by an authorized officer of Silergy. In case an individual agreement is concluded only the terms and conditions of the respective agreement shall apply. Silergy hereby expressly objects to and denies the application of any customer's general terms and conditions with regard to the purchase of Silergy products by the customer.
6. **No offer to sell or license.** Nothing in this document may be interpreted or construed as an offer to sell products that is open for acceptance or the grant, conveyance or implication of any license under any copyrights, patents or other industrial or intellectual property rights. Silergy makes no representation or warranty that any license, either express or implied, is granted under any patent right, copyright, mask work right, or other intellectual property right. Information published by Silergy regarding third-party products or services does not constitute a license to use such products or services or a warranty or endorsement thereof. Use of such information may require a license from a third party under the patents or other intellectual property of the third party, or a license from Silergy under the patents or other intellectual property of Silergy.

For more information, please visit: www.silergy.com

© 2020 Silergy Corp.

All Rights Reserved.

X-ON Electronics

Largest Supplier of Electrical and Electronic Components

Click to view similar products for [LDO Voltage Regulators](#) category:

Click to view products by [Silergy](#) manufacturer:

Other Similar products are found below :

[AP7363-SP-13](#) [NCV8664CST33T3G](#) [L79M05TL-E](#) [AP7362-HA-7](#) [PT7M8202B12TA5EX](#) [TCR3DF185,LM\(CT](#) [TLF4949EJ](#)
[NCP4687DH15T1G](#) [NCV8703MX30TCG](#) [LP2951CN](#) [NCV4269CPD50R2G](#) [AP7315-25W5-7](#) [AP2111H-1.2TRG1](#) [ZLDO1117QK50TC](#)
[AZ1117ID-ADJTRG1](#) [NCP114BMX075TCG](#) [MC33269T-3.5G](#) [TLE4471GXT](#) [AP7315-33SA-7](#) [NCV4266-2CST33T3G](#) [NCP715SQ15T2G](#)
[NCV8623MN-50R2G](#) [NCV563SQ18T1G](#) [NCV8664CDT33RKG](#) [NCV4299CD250R2G](#) [NCP715MX30TBG](#) [NCV8702MX25TCG](#)
[L974113TR](#) [TLE7270-2E](#) [NCV562SQ25T1G](#) [AP2202K-2.6TRE1](#) [NCV8170BMX300TCG](#) [NCV8152MX300180TCG](#) [NCP700CMT45TBG](#)
[AP7315-33W5-7](#) [LD56100DPU28R](#) [NCP154MX180300TAG](#) [AP2113AMTR-G1](#) [NJW4104U2-33A-TE1](#) [MP2013AGG-5-P](#)
[NCV8775CDT50RKG](#) [NJM2878F3-45-TE1](#) [S-19214B00A-V5T2U7](#) [S-19214B50A-V5T2U7](#) [S-19213B50A-V5T2U7](#) [S-19214BC0A-](#)
[E8T1U7*1](#) [S-19213B00A-V5T2U7](#) [S-19213B33A-V5T2U7](#) [S-19213BC0A-V5T2U7](#) [S-1313D18-N4T1U4](#)