



SILERGY

SY20807B/C/L/Z

Low Loss Power Distribution Switch With Programmable Current Limit

General Description

The SY20807 is a current-limited P-channel MOSFET power switch designed for USB load-switching or hot-plug applications. Its ultra-low $R_{DS(ON)}$ and current limit protect the power source from overcurrent and short-circuit conditions. An external resistor is used to configure the current limit threshold between 0.2A and 2A. An open-drain output can be used to detect fault events.

The device incorporates overtemperature protection and reverse blocking functions.

Different versions of the part, SY20807B/C/L/Z, are available in 2mm x 2mm DFN and SOT23-6 packages.

Applications

- USB 3.1 Applications
- USB 3G Data Cards
- USB Dongles
- Mini PCI Accessories
- USB Chargers
- Public Place Multi-USB Chargers
- PC Card Hotswap Applications

Features

- Input Voltage: 2.5V to 5.5V
- Extremely Low Power Path Resistance: 65mΩ (Typ.)
- Adjustable Current Limit Up to 2.0A
- Overtemperature Shutdown and Automatic Retry
 - SY20807B/C/Z: Automatic Retry
 - SY20807L: Latch Off After Current Limit 2ms
- Automatic Output Discharge at Shutdown
 - SY20807L/Z: Auto Output Voltage Discharge
 - SY20807B/C: No Output Voltage Discharge
- Fast Trip Protection Logic During V_{OUT} Hard Short
 - SY20807Z: 2μs short circuit response time
 - SY20807B/C/L: 25μs current limit response time
- Enable Polarity
 - SY20807C/L/Z: Active High
 - SY20807B: Active Low
- Reverse Blocking (No Body Diode)
- Fault Flag (OCB) Output for Over Current and Fault Conditions
- Built-in Soft-Start
- Compact Package: DFN2x2-6/SOT23-6
- RoHS Compliant and Halogen Free
- UL(CB) Certification No. E491480

Typical Application Circuit

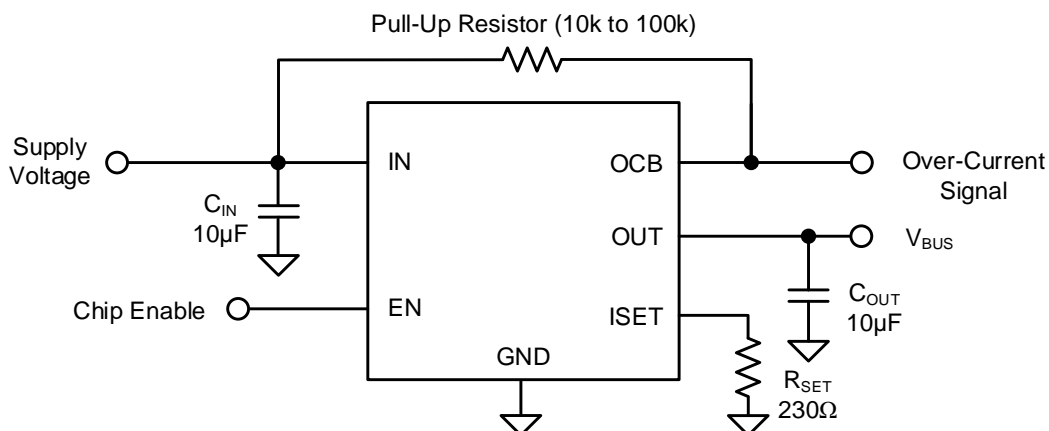

Figure 1. Schematic Diagram

Ordering Information

Part Number	Package Type	Top Mark ^①
SY20807BDEC	DFN2x2-6	mKxyz
SY20807CDEC	DFN2x2-6	cMxyz
SY20807CABC	SOT23-6	cLxyz
SY20807LABC	SOT23-6	N8xyz
SY20807ZDEC	DFN2x2-6	nBxyz

x=year code, y=week code, z=lot number code.

Pinout (Top View)

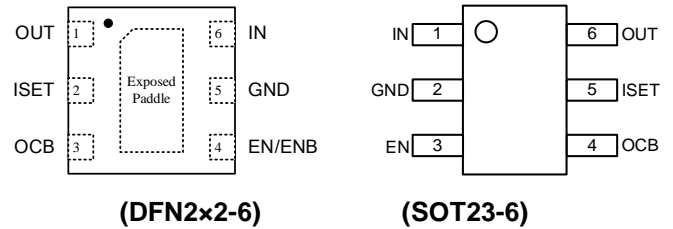

Pin Name	Pin Number		Pin Description
	DFN2x2	SOT23-6	
IN	6	1	Input pin, decoupled with a 10μF capacitor to GND.
GND	5, Exposed Paddle	2	Ground pin.
OUT	1	6	Output pin, decoupled with a 10μF capacitor to GND.
EN	4	3	ON/OFF control, active high. Do not leave it floating.
ISET	2	5	Current limit programming pin. Connect a resistor R _{SET} from this pin to the ground to program the current limit: I _{LIM} (A)=230/R _{SET} (Ω).
OCB	3	4	Open-drain fault flag.

Block Diagram

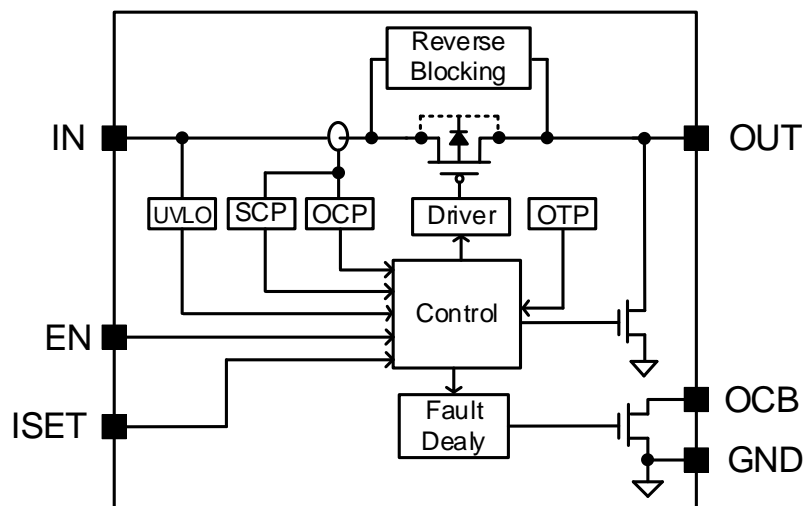

SY20807Z

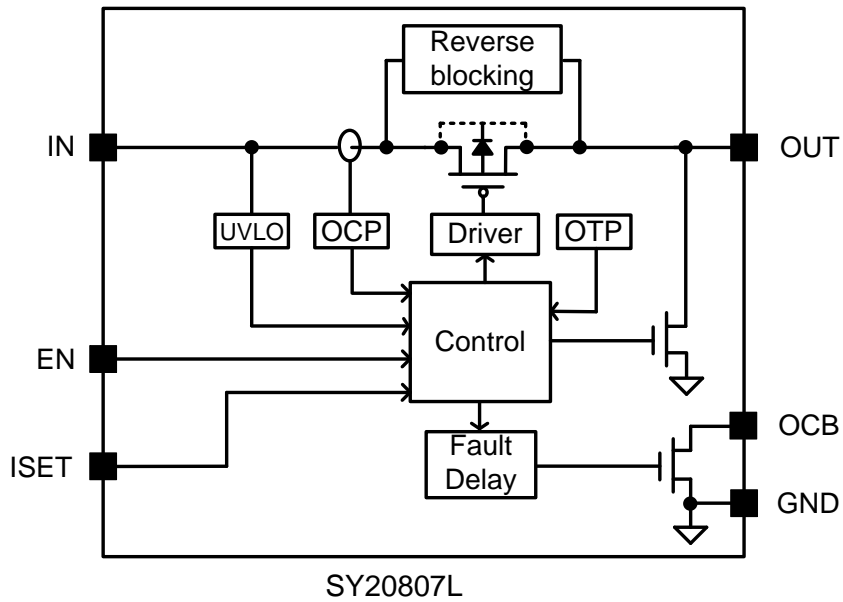
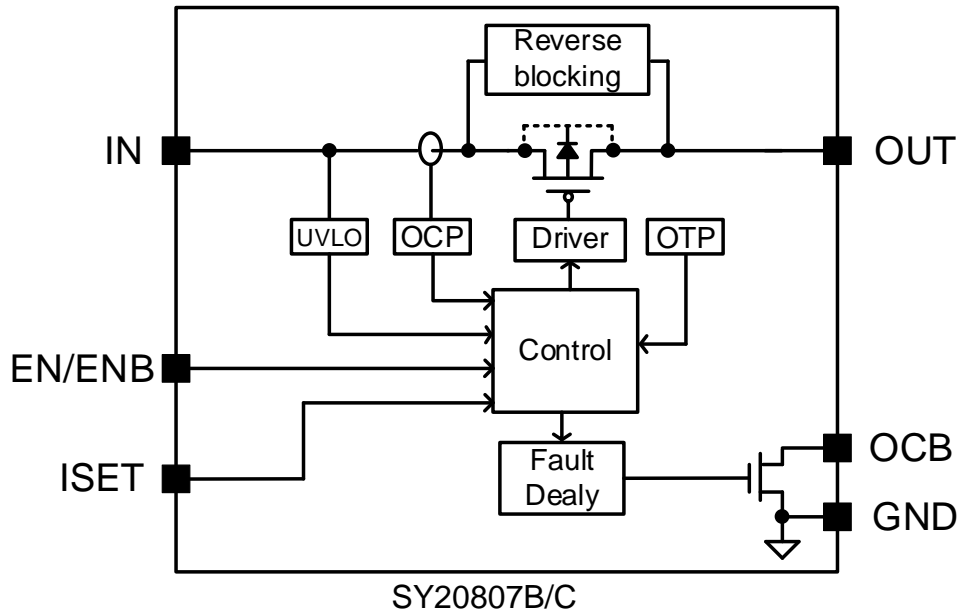

Figure 2. Block Diagram

Absolute Maximum Ratings

Parameter (Note1)	Min	Max	Unit
IN, OUT	-0.3	7	V
ISET, OCB, EN	-0.3	7	
Lead Temperature (Soldering, 10 sec.)		260	°C
Junction Temperature, Operating	-40	150	
Storage Temperature	-65	150	

Thermal Information

Parameter (Note2)	Typ	Unit
θ_{JA} Junction-to-ambient Thermal Resistance (DFN2x2-6/ SOT23-6)	65.3/106.4	°C/W
θ_{JC} Junction-to-case Thermal Resistance (DFN2x2-6/ SOT23-6)	16.2/41.7	
P_D Power Dissipation $T_A = 25^\circ\text{C}$ (DFN2x2-6/ SOT23-6)	1.53/0.94	W

Recommended Operating Conditions

Parameter (Note 3)	Min	Max	Unit
IN, OUT	2.5	5.5	V
ISET, OCB, EN	0	5.5	
Junction Temperature, Operating	-40	125	°C
Ambient Temperature	-40	85	

Electrical Characteristics

($V_{IN} = 5V$, $C_{OUT} = 10\mu F$, $T_A = 25^\circ\text{C}$, BOLD values indicate -40°C to 85°C , unless otherwise specified.)

Parameter	Symbol	Test Conditions	Min	Typ	Max	Unit
Input Voltage Range	V_{IN}		2.5		5.5	V
IN UVLO Threshold	$V_{IN,UVLO}$				2.45	V
IN UVLO Hysteresis	$V_{IN,HYS}$			0.1		V
Shutdown Input Current	I_{SHDN}	Open load, switch off		0.1	5	μA
		Output grounded, switch off		0.1	5	μA
Reverse Leakage Current		IN tied to GND, $V_{OUT} = 5V$		0.1	5	μA
Reverse Blocking Threshold	V_{RBT}	$V_{OUT} - V_{IN}$		100		mV
Reverse Blocking Recovery Threshold	V_{RBT_REC}	$V_{OUT} - V_{IN}$		-30		mV
Quiescent Supply Current	I_Q	Open load, switch on		45	100	μA
FET $R_{DS(ON)}$	$R_{DS(ON)}$	$V_{IN} = 5V$, $I_{OUT} = 0.5A$		65	100	m Ω
Current Limit	I_{LIM}	$V_{OUT} = 4V$, $R_{SET} = 460\Omega$ (Note 5)	0.425	0.5	0.575	A
		$V_{OUT} = 4V$, $R_{SET} = 153.3\Omega$ (Note 5)	1.382	1.5	1.617	A
EN/ $\overline{\text{EN}}$ Threshold	Logic-Low Voltage	V_{IL}			0.4	V
	Logic-High Voltage	V_{IH}	1.0			V
EN Input Cap	C_{EN}	Note 4		1		pF
EN Leakage Current	I_{ENLK}				1	μA

Parameter	Symbol	Test Conditions	Min	Typ	Max	Unit
Output Turn On Time	t _{ON}	R _L =10Ω, C _L =1μF. Measure from EN ON until V _{OUT} reaches V _{IN} ×90%	1	2	5	ms
Output Turn On Rise Time	t _r	R _L =10Ω, C _L =1μF. Measure from V _{OUT} =10% of V _{IN} to 90% of V _{IN}	1	2	5	ms
Output Turn Off Time	t _{OFF}	R _L =10Ω, C _L =1μF. Measure from EN OFF until V _{OUT} reaches V _{IN} ×10%		22		μs
Output Turn Off Fall Time	t _f	R _L =10Ω, C _L =1μF. Measure from V _{OUT} =90% of V _{IN} to 10% of V _{IN}		21		μs
OCB Low Resistance	R _{OCB}	V _{IN} =5V, I _L =10μA		9		Ω
		V _{IN} =3.3V, I _L =10μA		12		Ω
OUT Shutdown Discharge Resistance	R _{DSG}	EN=0, V _{OUT} =0.1V, Only for SY20807Z		25		Ω
		EN=0, V _{OUT} =0.1V, Only for SY20807L		150		Ω
OCB Leakage Current	I _{LKG_OCB}	V _{OCB} =5V		0.01	1	μA
Thermal Shutdown Temperature	T _{SD}			150		°C
Thermal Shutdown Hysteresis	T _{HYS}			20		°C
Current Limit Latch Off Time	t _{OC_OFF}	I _{LOAD} =1.2I _{LIMIT} (Note 5). Measure from I _{OUT} >I _{LIMIT} to Power FET shutdown, Only for SY20807L		2		ms
Current Limit Response Time	t _{OC_RES}	I _{LOAD} =1.2I _{LIMIT} (Note 4, Note 5)		25		μs
Short Circuit Response Time	t _{OC}	I _{LOAD} =1.5I _{LIMIT} (Note 4, Note 5), Only for SY20807Z		2		μs
Over Current Flag Response Time	t _{OCB}	I _{LOAD} =1.2I _{LIMIT} (Note 5), for SY20807B/C/Z	4	8	12	μs
		I _{LOAD} =1.2I _{LIMIT} (Note 5), For SY20807L		2		ms
Reverse Blocking Response Time	t _{RBT}	Note 4		800		ns

Note 1: Stresses beyond the “Absolute Maximum Ratings” may cause permanent damage to the device. These are stress ratings only. Functional operation of the device at these or any other conditions beyond those indicated in the operational sections of the specification is not implied. Exposure to absolute maximum rating conditions for extended periods may affect device reliability.

Note 2: θ_{JA} is measured in the natural convection at T_A = 25°C on a Silergy’s test board. The exposed paddle of DFN2×2-6 packages is the case position for θ_{JC} measurement.

Note 3: The device is not guaranteed to function outside its operating conditions.

Note 4: Guaranteed by design but not production tested.

Note5: Current limit threshold is determined by I_{LIMIT}=230V/R_{SET}, where R_{SET} is in Ω.

Typical Performance Characteristics

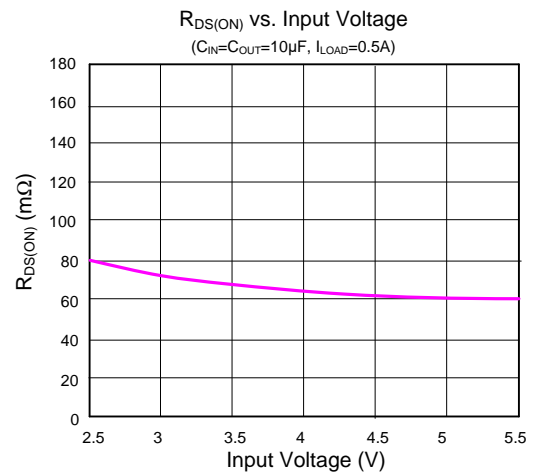
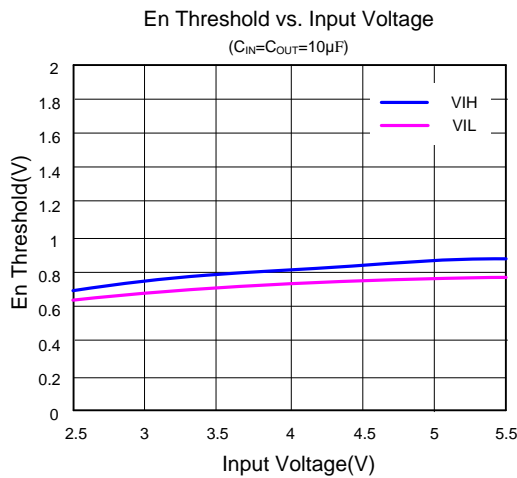
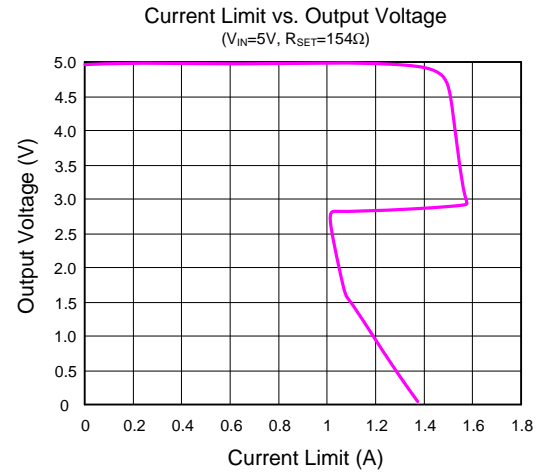
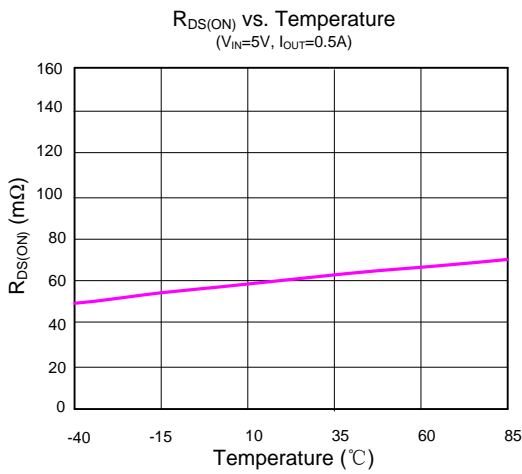
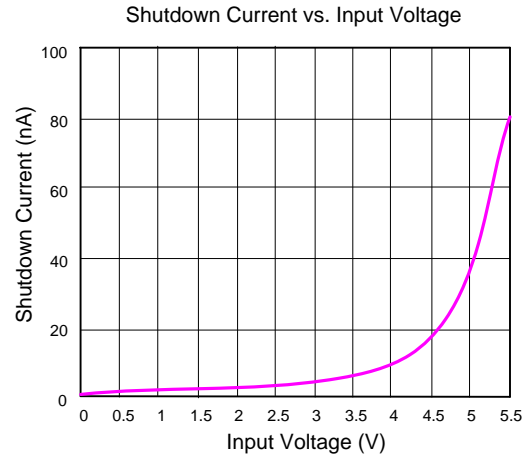
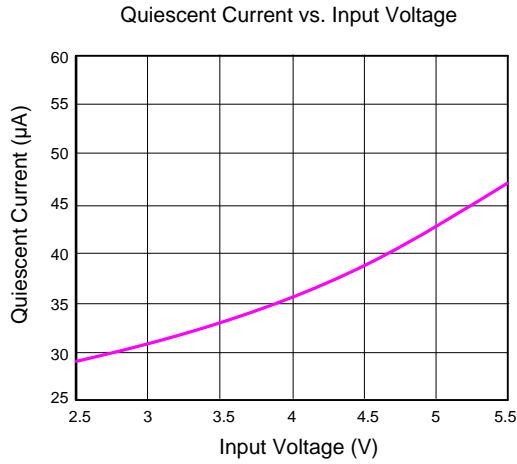

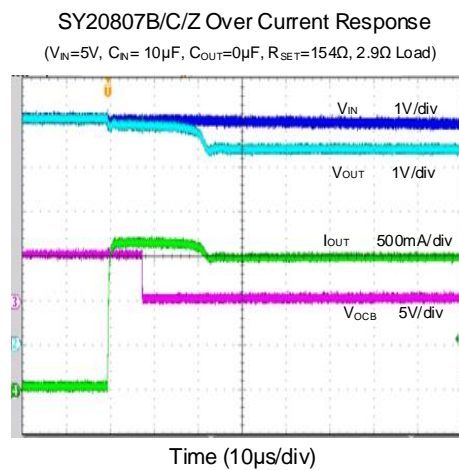
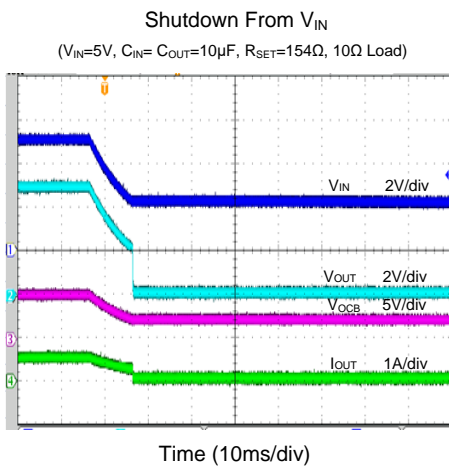
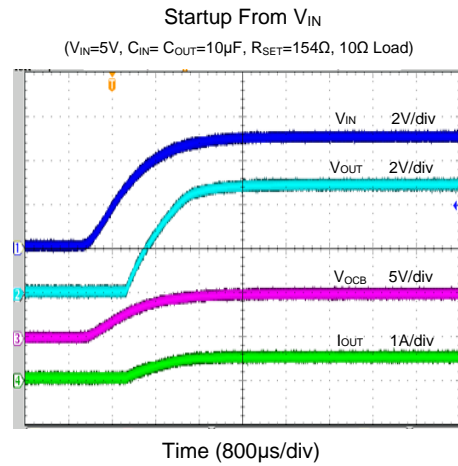
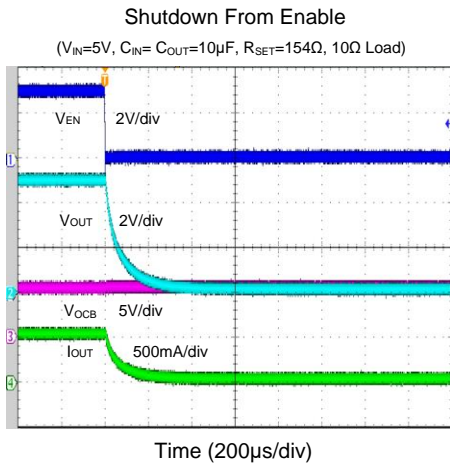
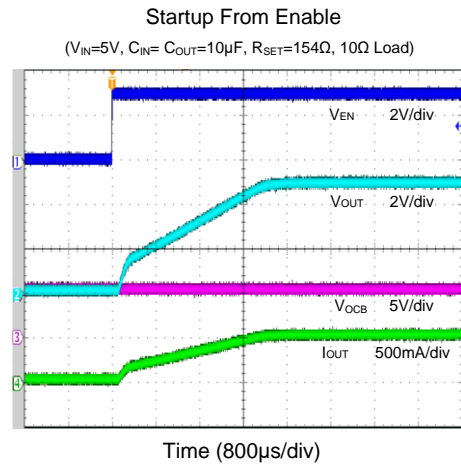
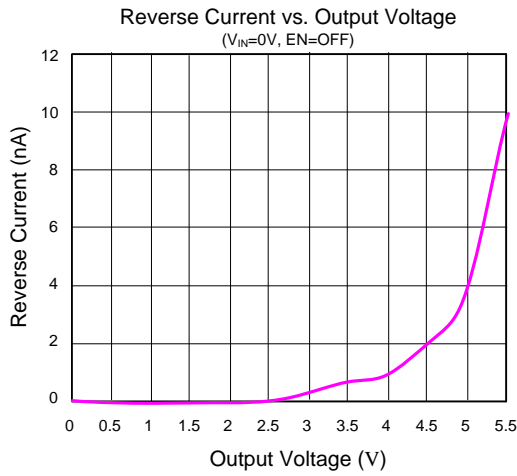

SY20807L Over Current Response

($V_{IN}=5V$, $C_{IN}=10\mu F$, $C_{OUT}=0\mu F$, $R_{SET}=154\Omega$, 2.5Ω Load)

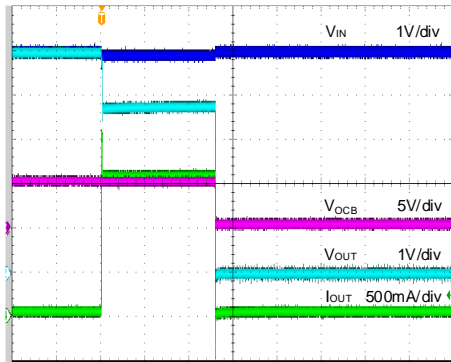

Time (800µs/div)

SY20807Z Short Circuit Response

($V_{IN}=5V$, $C_{IN}=C_{OUT}=10\mu F$)

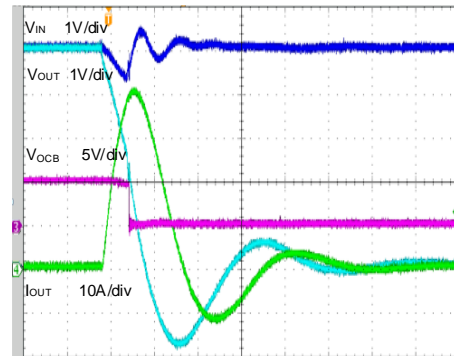

Time (2µs/div)

SY20807B/C Short Circuit Response

($V_{IN}=5V$, $C_{IN}=C_{OUT}=10\mu F$)

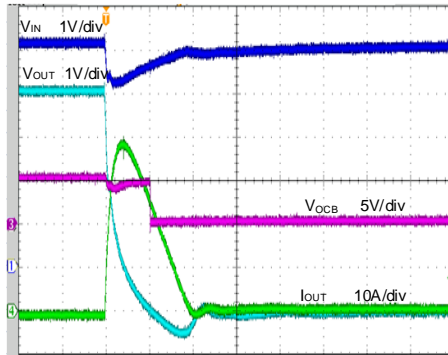

Time (10µs/div)

Application Information

The SY20807 is a current-limited P-channel MOSFET power switch designed for USB load-switching or hot-plug applications. It incorporates a reverse blocking function, which prevents current flow from OUT to IN when OUT is externally forced to a higher voltage than IN.

Overcurrent Protection:

The SY20807 supports current limit programming. Connect a resistor R_{SET} from ISET pin to the ground to program the current limit:

$$I_{LIM} (A) = 230 / R_{SET} (\Omega)$$

The minimum current limit is 0.2A. A current limit beyond 2A is not recommended.

When the overcurrent condition is sensed, the gate of the pass switch is modulated to achieve a constant output current. If the overcurrent condition persists for a long time, the junction temperature may exceed 150°C, and overtemperature protection will shut down the part. Once the chip temperature drops below 130°C, the part will restart.

Table 1. Current Limit vs. R_{SET}

$R_{SET}(\Omega)$	Current Limit Threshold(mA)		
	MIN	TYP	MAX
460.0	425	500	575
153.3	1380	1500	1620

The current limit of device will be folded back at about $60\% \times I_{LIMIT}$ to decrease power dissipation when $V_{OUT} < 50\% \times V_{IN}$.

Latch off Protection:

The SY20807L uses a latch off protection. Once the junction temperature exceeds 150°C or over current conditions exceeds 2ms, the SY20807L will shut down and latch off. Toggling the EN pin or V_{IN} dropping below UVLO can reset IC.

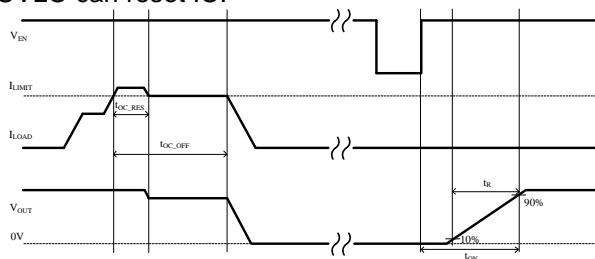

Short Circuit Protection:

During short circuit conditions, the current limit loop may not respond fast enough to prevent overcurrent. The SY20807Z provides a fast trip logic to avoid large short circuit current. When the load current exceeds 1.5 times of current limit threshold, the Power FET will be shutdown for 2us first, and then the circuit will start controlling the gate of Power FET in current limit mode.

Fault Flag (OCB):

The OCB output is asserted (active-low) when thermal shutdown protection is triggered or an overcurrent condition persists for longer than 8us. The output remains asserted until the fault condition is removed. Connecting a heavy capacitance load to an enabled device can cause a momentary overcurrent condition; however, no false reporting on the OCB occurs due to an 8us deglitch circuit.

Supply Filter Capacitor:

In order to prevent significant input voltage drop during hot-plug events, a 10μF ceramic capacitor from V_{IN} to GND is strongly recommended. Higher capacitor values can further reduce the input voltage drop. Without an input capacitor, an output short can cause ringing at the input, which could destroy the internal circuitry when the input transient exceeds the absolute maximum supply voltage, even for a short duration.

Output Filter Capacitor:

A 10μF output ceramic capacitor is recommended to be placed close to the device and output connector to reduce voltage drop during load transients. Higher output capacitor values can further reduce the drop during high-current applications.

Reverse Block Function:

The SY20807 integrates a reverse blocking function. Once the voltage between the OUT and IN pins exceeds 100mV, reverse blocking will be triggered. The power FET will be shut down in 700ns, blocking the reverse current flow from OUT to IN.

PCB Layout Guide:

For best performance of the SY20807, the following guidelines must be followed:

1. Keep all VBUS traces as short and wide as possible and use at least 2 ounce copper for all VBUS traces.
2. Place the output capacitor as close to the connectors as possible to lower the impedance and inductance between the port and the capacitor and improve transient performance.
3. Place the input and output capacitors close to the device and connect them to the ground plane to reduce noise coupling.

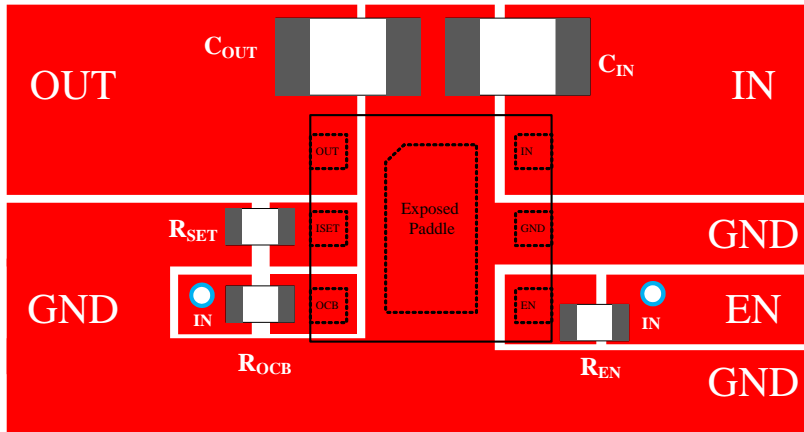

Figure 3. SY20807ZDEC PCB Layout Example

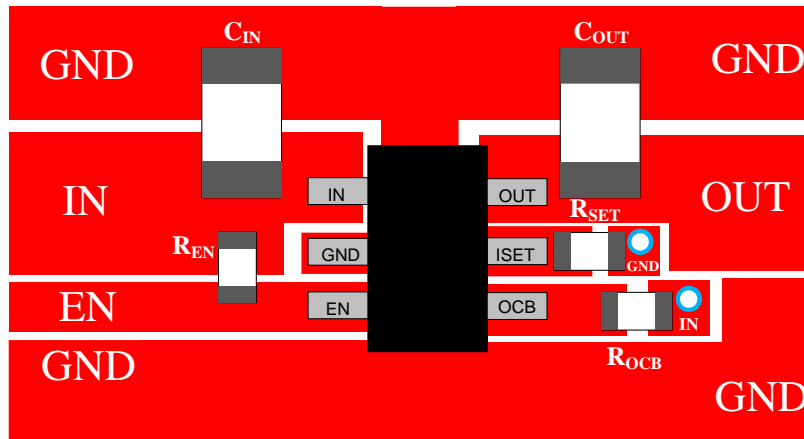
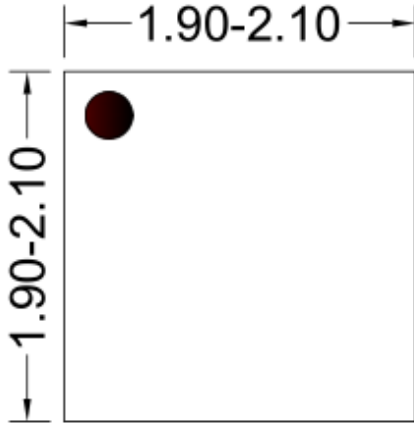
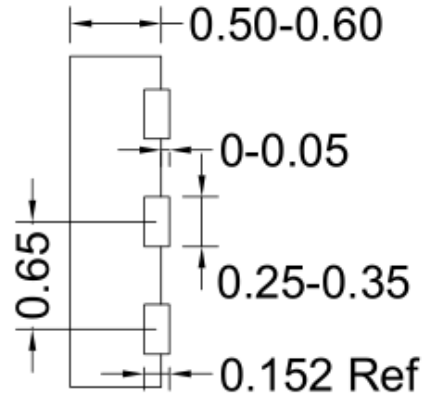

Figure 4. SY20807CABC PCB Layout Example

DFN2x2-6 Package Outline



Top View



Side View

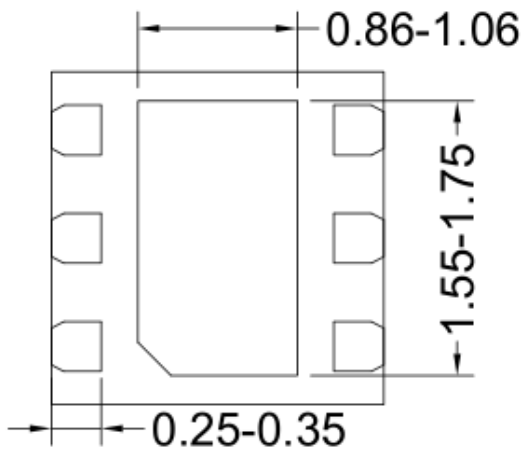

Bottom View

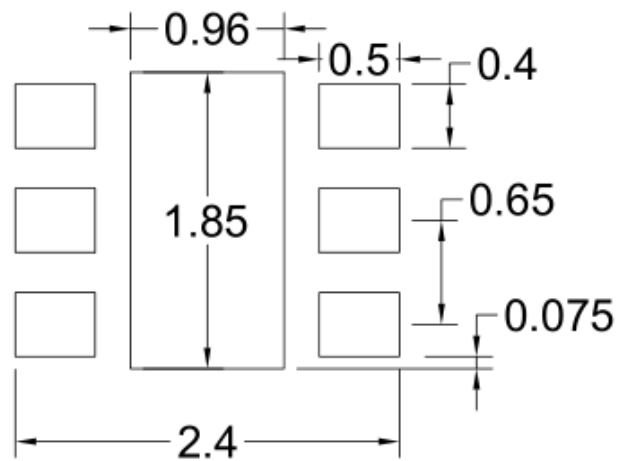

Recommended PAD Layout

Note: All dimensions are in millimeters and exclude mold flash and metal burr.

SOT23-6 Package Outline & PCB Layout

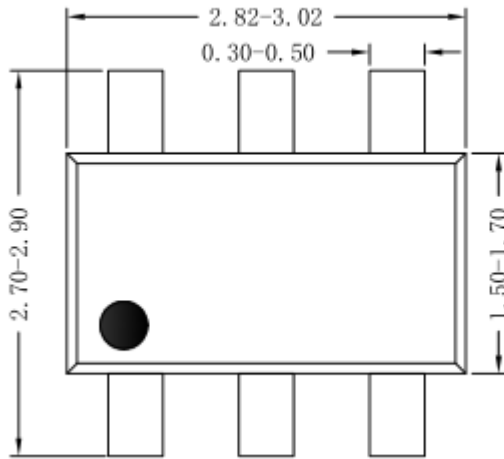

Top View

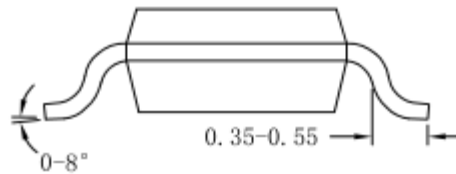

Side View

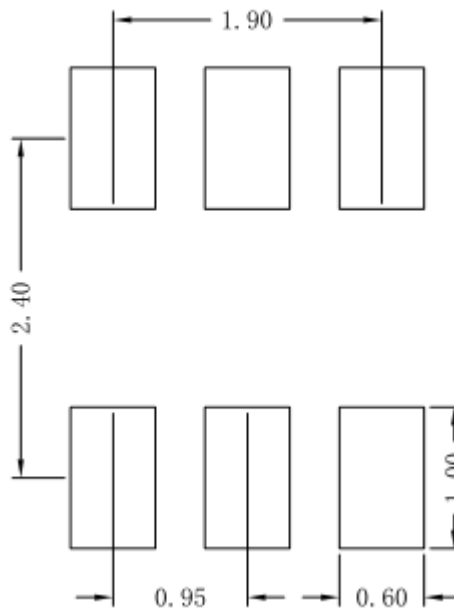

Recommended Pad Layout

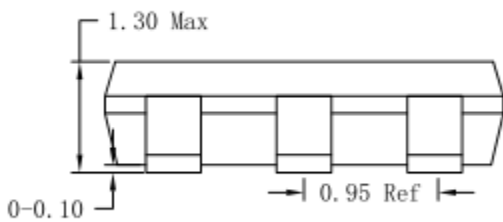

Side View

Notes: All dimension in millimeter and exclude mold flash & metal burr.

Taping & Reel Specification

1. Taping Orientation

DFN2x2

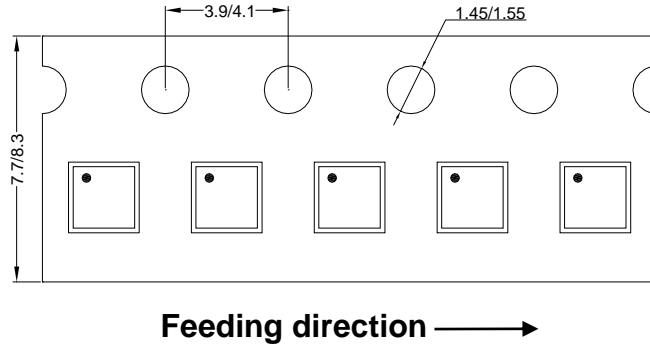

SOT23-6

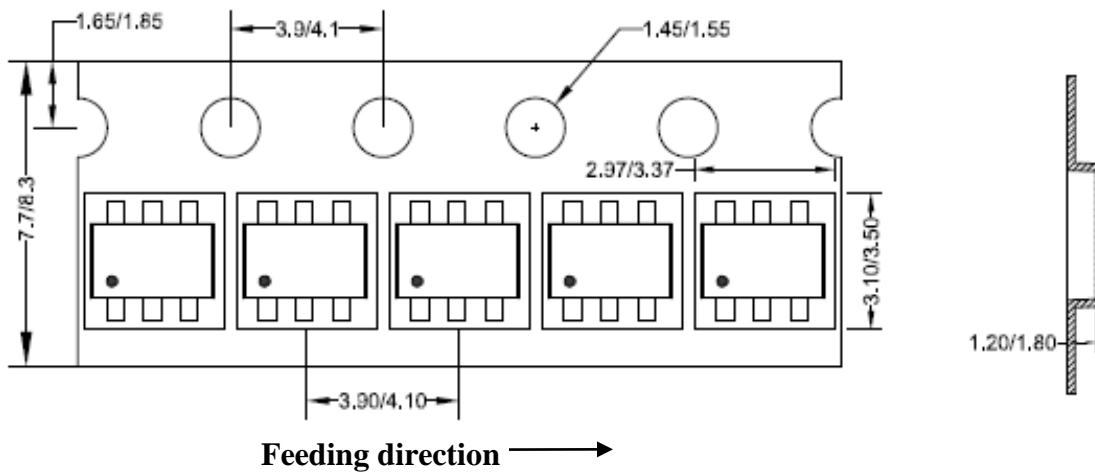

2. Carrier Tape & Reel Specification for Packages

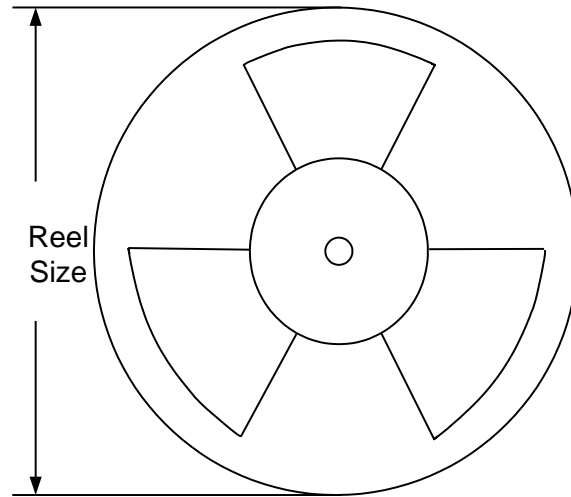

Package types	Tape width (mm)	Pocket pitch (mm)	Reel size (Inch)	Trailer length (mm)	Leader length (mm)	Qty per reel
SOT23-6	8	4	7"	280	160	3000
DFN2x2	8	4	7"	400	160	3000

3. Others: NA



Revision History

The revision history provided is for informational purpose only and is believed to be accurate, however, not warranted. Please make sure that you have the latest revision.

Date	Revision	Change
Nov,17, 2023	Revision 1.0	Initial Release



IMPORTANT NOTICE

- 1. Right to make changes.** Silergy and its subsidiaries (hereafter Silergy) reserve the right to change any information published in this document, including but not limited to circuitry, specification and/or product design, manufacturing or descriptions, at any time and without notice. This document supersedes and replaces all information supplied prior to the publication hereof. Buyers should obtain the latest relevant information before placing orders and should verify that such information is current and complete. All semiconductor products are sold subject to Silergy's standard terms and conditions of sale.
- 2. Applications.** Application examples that are described herein for any of these products are for illustrative purposes only. Silergy makes no representation or warranty that such applications will be suitable for the specified use without further testing or modification. Buyers are responsible for the design and operation of their applications and products using Silergy products. Silergy or its subsidiaries assume no liability for any application assistance or designs of customer products. It is customer's sole responsibility to determine whether the Silergy product is suitable and fit for the customer's applications and products planned. To minimize the risks associated with customer's products and applications, customer should provide adequate design and operating safeguards. Customer represents and agrees that it has all the necessary expertise to create and implement safeguards which anticipate dangerous consequences of failures, monitor failures and their consequences, lessen the likelihood of failures that might cause harm and take appropriate remedial actions. Silergy assumes no liability related to any default, damage, costs or problem in the customer's applications or products, or the application or use by customer's third-party buyers. Customer will fully indemnify Silergy, its subsidiaries, and their representatives against any damages arising out of the use of any Silergy components in safety-critical applications. It is also buyers' sole responsibility to warrant and guarantee that any intellectual property rights of a third party are not infringed upon when integrating Silergy products into any application. Silergy assumes no responsibility for any said applications or for any use of any circuitry other than circuitry entirely embodied in a Silergy product.
- 3. Limited warranty and liability.** Information furnished by Silergy in this document is believed to be accurate and reliable. However, Silergy makes no representation or warranty, expressed or implied, as to the accuracy or completeness of such information and shall have no liability for the consequences of use of such information. In no event shall Silergy be liable for any indirect, incidental, punitive, special or consequential damages, including but not limited to lost profits, lost savings, business interruption, costs related to the removal or replacement of any products or rework charges, whether or not such damages are based on tort or negligence, warranty, breach of contract or any other legal theory. Notwithstanding any damages that customer might incur for any reason whatsoever, Silergy' aggregate and cumulative liability towards customer for the products described herein shall be limited in accordance with the Standard Terms and Conditions of Sale of Silergy.
- 4. Suitability for use.** Customer acknowledges and agrees that it is solely responsible for compliance with all legal, regulatory and safety-related requirements concerning its products, and any use of Silergy components in its applications, notwithstanding any applications-related information or support that may be provided by Silergy. Silergy products are not designed, authorized or warranted to be suitable for use in life support, life-critical or safety-critical systems or equipment, nor in applications where failure or malfunction of an Silergy product can reasonably be expected to result in personal injury, death or severe property or environmental damage. Silergy assumes no liability for inclusion and/or use of Silergy products in such equipment or applications and therefore such inclusion and/or use is at the customer's own risk.
- 5. Terms and conditions of commercial sale.** Silergy products are sold subject to the standard terms and conditions of commercial sale, as published at <http://www.silergy.com/stdterms>, unless otherwise agreed in a valid written individual agreement specifically agreed to in writing by an authorized officer of Silergy. In case an individual agreement is concluded only the terms and conditions of the respective agreement shall apply. Silergy hereby expressly objects to and denies the application of any customer's general terms and conditions with regard to the purchase of Silergy products by the customer.
- 6. No offer to sell or license.** Nothing in this document may be interpreted or construed as an offer to sell products that is open for acceptance or the grant, conveyance or implication of any license under any copyrights, patents or other industrial or intellectual property rights. Silergy makes no representation or warranty that any license, either express or implied, is granted under any patent right, copyright, mask work right, or other intellectual property right. Information published by Silergy regarding third-party products or services does not constitute a license to use such products or services or a warranty or endorsement thereof. Use of such information may require a license from a third party under the patents or other intellectual property of the third party, or a license from Silergy under the patents or other intellectual property of Silergy.

For more information, please visit: www.silergy.com

© 2019 Silergy Corp.

All Rights Reserved.

X-ON Electronics

Largest Supplier of Electrical and Electronic Components

Click to view similar products for [Power Switch ICs - Power Distribution](#) category:

Click to view products by [Silergy](#) manufacturer:

Other Similar products are found below :

[TLE6232GP](#) [NCP45520IMNTWG-L](#) [VND5E004ATR-E](#) [FPF1018](#) [DS1222](#) [NCV380HMUAJAATBG](#) [SZNCP3712ASNT3G](#)
[NCP45520IMNTWG-H](#) [VND5004ATR-E](#) [AP22811BW5-7](#) [SLG5NT1437VTR](#) [SZNCP3712ASNT1G](#) [DML1008LDS-7](#) [TS13011-QFNR](#)
[VND7012AYTR](#) [NCV459MNWTBG](#) [NCP4545IMNTWG-L](#) [NCV8412ASTT1G](#) [NCV8412ASTT3G](#) [FPF2260ATMX](#) [SLG5NT1765V](#)
[SLG5NT1757V](#) [NCP45780IMN24RTWG](#) [AP2151AMP-13](#) [NCP45540IMNTWG-L](#) [TPS2022P](#) [FPF2495BUCX](#) [NCP45650IMNTWG](#)
[DK5V100R20S](#) [BTS7020-2EPA](#) [BTT6100-2ERA](#) [BTS71220-4ESA](#) [DK5V100R15M](#) [WS3220C9-9/TR](#) [AW32405CSR](#) [BTT6030-2ERA](#)
[TLE75602-ESH](#) [BTS5200-4EKA](#) [DK5V150R25M](#) [DK5V45R25](#) [DK5V100R25S](#) [AW35206FOR](#) [BTS7120-2EPA](#) [TLE75008-ESD](#)
[BTS7040-1EPA](#) [BTT6030-1ERA](#) [DK5V60R10S](#) [DK5V45R25S](#) [DK5V60R10](#) [DK5V45R15S](#)