

General Description

The SY21019 high-efficiency asynchronous Buck converter can deliver 300mA output current over a wide input voltage range from 5V to 40V. The SY21019 employs a constant off-time and peak-current mode control strategy to achieve fast transient responses. It integrates a main switch with low $R_{DS(ON)}$ to minimize conduction loss.

The 2MHz switching frequency permits low output-voltage ripple and reduces external inductor and capacitor sizes. The SY21019 also provides cycle-by-cycle current limiting, over temperature protection, and output short-circuit protection.

The SY21019 is available in a compact SOT23-6 package.

Features

- Low $R_{DS(ON)}$ for Internal N-Channel Power FET: 2Ω
- 5V to 40V Input Voltage Range
- Up to 300mA Output Current
- 2MHz Switching Frequency
- Constant Off-Time and Peak-Current Mode Control
- Internal Soft-Start Limits Inrush Current
- $\pm 2\%$ 0.6V Reference
- Output Short-Circuit Protection
- Cycle-by-Cycle Peak Current Limit
- Over Temperature Protection
- RoHS-Compliant and Halogen-Free
- Compact SOT23-6 Package

Applications

- Smart Meter
- Set-Top Box
- Portable TV
- Access Point Router
- DSL Modem
- LCD TV

Typical Application

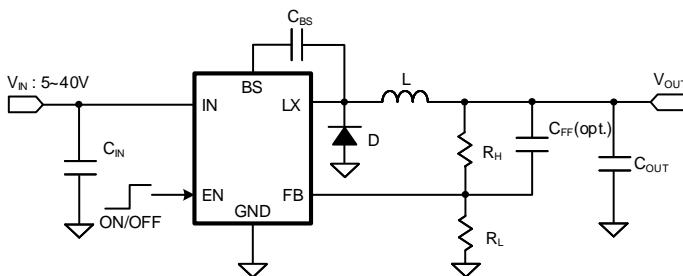

Figure 1. Typical Application Circuit

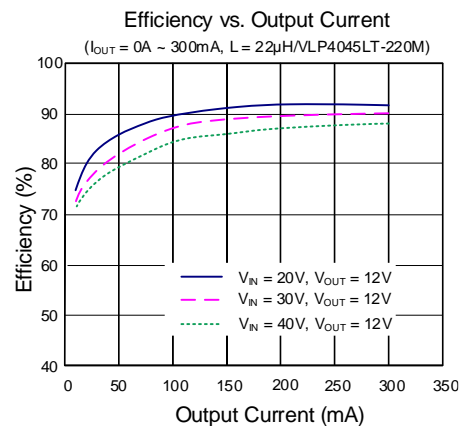

Figure 2. Efficiency vs. Output Current



Ordering Information

Ordering Part Number	Package type	Top Mark
SY21019ABC	SOT23-6 RoHS-Compliant and Halogen-Free	TExyz

x = year code, y = week code, z = lot number code

Pinout (top view)

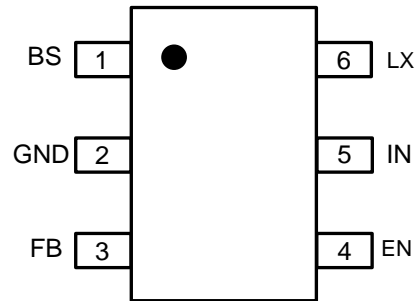

(SOT23-6)

Pin Description

Pin No	Pin Name	Pin Description
1	BS	Bootstrap pin. Supply for high-side gate driver. Connect a 0.1μF ceramic capacitor between the BS and LX pin.
2	GND	Ground pin.
3	FB	Output feedback pin. Connect this pin to the center point of the output resistor-divider as shown in Figure 1. $V_{OUT} = 0.6 \times (1 + R_H/R_L)$.
4	EN	Enable pin. Pull low to disable the device, pull high to enable. Do not leave this pin floating.
5	IN	Power input. Decouple this pin from the GND pin with at least a 1μF ceramic capacitor.
6	LX	Inductor pin. Connect this pin to the switching node of inductor and rectifier diode.

Block Diagram

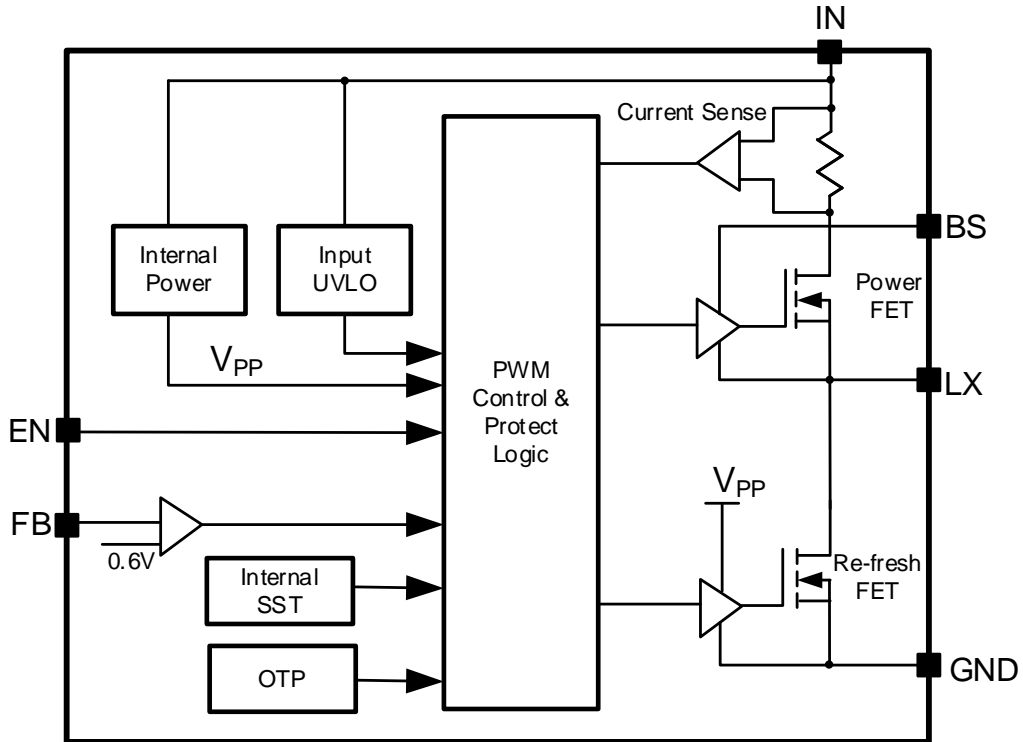

Figure 3. Block Diagram

Absolute Maximum Ratings

Parameter (Note 1)	Min	Max	Unit
IN, LX	-0.3	42	V
EN	-0.3	$V_{IN} + 0.6$	
FB, BS-LX	-0.3	3.6	
Junction Temperature, Operating	-40	150	°C
Lead Temperature (Soldering, 10s)		260	
Storage Temperature	-65	150	

Thermal Information

Parameter (Note 2)	Typ	Unit
θ_{JA} Junction-to-Ambient Thermal Resistance	170	°C/W
θ_{JC} Junction-to-Case Thermal Resistance	130	
P_D Power Dissipation $T_A = 25^\circ\text{C}$	0.6	W

Recommended Operating Conditions

Parameter (Note 3)	Min	Max	Unit
Supply Input Voltage	5	40	V
BS-LX Voltage		3.3	
Output Current		300	mA
Junction Temperature	-40	125	°C
Ambient Temperature	-40	85	

Electrical Characteristics

($V_{IN} = 20V$, $V_{OUT} = 12V$, $L = 22\mu H$, $C_{OUT} = 4.7\mu F$, $T_A = 25^\circ C$, $I_{OUT} = 100mA$ unless otherwise specified)

Parameter	Symbol	Test Conditions	Min	Typ	Max	Unit	
Input	Voltage	V_{IN}	5		40	V	
	UVLO Rising Threshold	$V_{IN,UVLO}$		4.5			
	UVLO Hysteresis	V_{HYS}		200		mV	
	Quiescent Current	I_Q	$I_{OUT} = 0A$, $V_{FB} = 105\% \times V_{REF}$		160		μA
	Shutdown Current	I_{SHDN}	$V_{EN} = 0V$			10	
Output	Reference Voltage	V_{REF}	0.588	0.6	0.612	V	
	FB Input Current	I_{FB}	$V_{FB} = V_{IN}$	-50	10	50	nA
	Soft-Start Time	t_{SS}		400		μs	
MOSFET	Power FET $R_{DS(ON)}$	$R_{DS(ON)}$		2		Ω	
	Power FET Current Limit	I_{LMT}	450			mA	
Enable (EN)	Input Voltage High	$V_{EN,H}$	1.5			V	
	Input Voltage Low	$V_{EN,L}$			0.4		
COT	Switching Frequency	f_{SW}	$I_{OUT} = 100mA$, CCM	1.6	2	2.4	MHz
	Minimum On-Time	$t_{ON,MIN}$			100		ns
	Minimum Off-Time	$t_{OFF,MIN}$			100		
OTP	Temperature	T_{OTP}		150		$^\circ C$	
	Temperature Hysteresis	T_{HYS}		15			

Note 1: Stresses beyond the “Absolute Maximum Ratings” may cause permanent damage to the device. These are stress ratings only. Functional operation of the device at these or any other conditions beyond those indicated in the operational sections of the specification is not implied. Exposure to absolute maximum rating conditions for extended periods may affect device reliability.

Note 2: θ_{JA} is measured in the natural convection at $T_A = 25^\circ C$ on a low effective single layer thermal conductivity test board of JEDEC 51-3 thermal measurement standard.

Note 3: The device is not guaranteed to function outside its operating conditions.

Typical Performance Characteristics

($V_{IN} = 20V$, $V_{OUT} = 12V$, $L = 22\mu H$, $C_{OUT} = 4.7\mu F$, $T_A = 25^\circ C$, $I_{OUT} = 300mA$, unless otherwise noted)

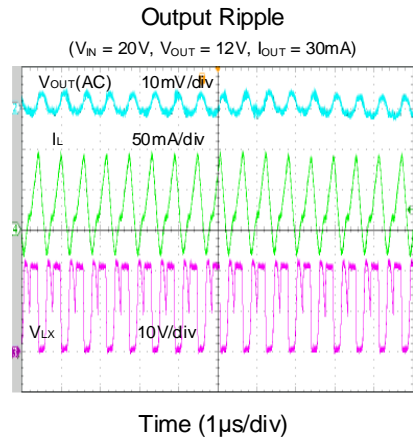
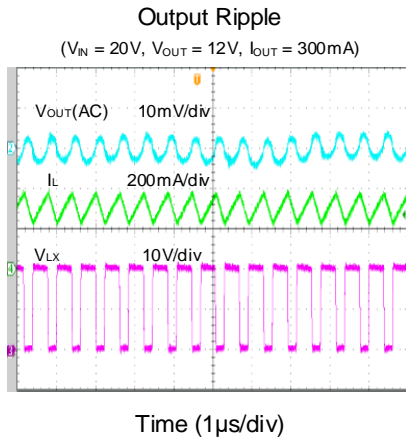
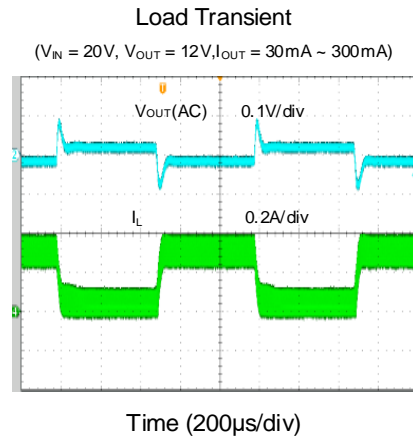
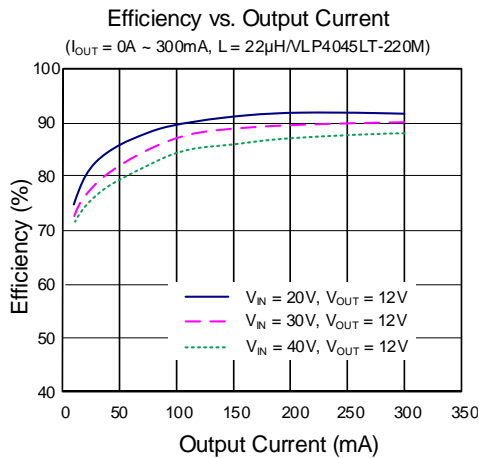
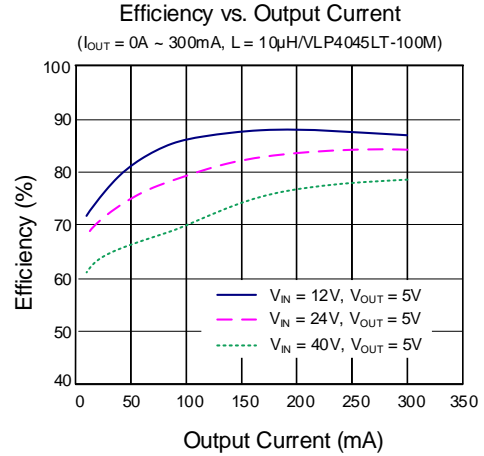
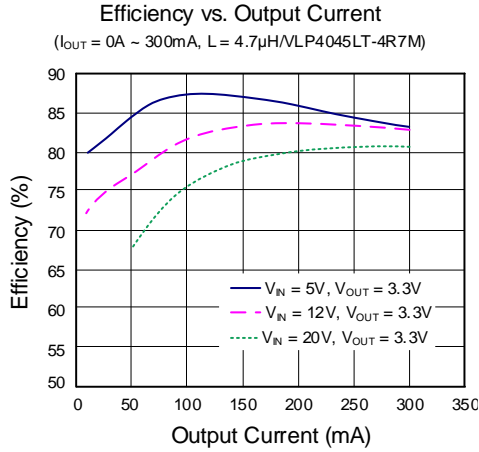

Startup From V_{IN}

($V_{IN} = 20V$, $V_{OUT} = 12V$, $I_{OUT} = 300mA$)

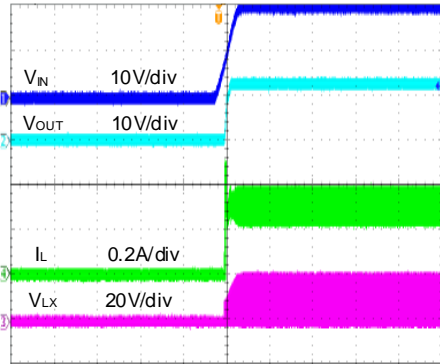

Time (4ms/div)

Shutdown From V_{IN}

($V_{IN} = 20V$, $V_{OUT} = 12V$, $I_{OUT} = 300mA$)

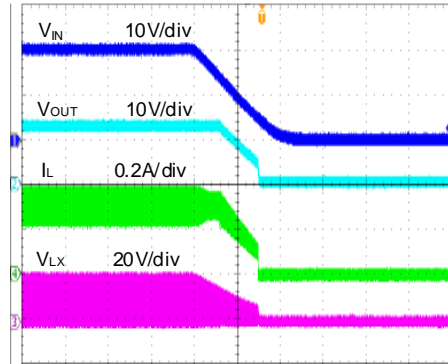

Time (20ms/div)

Startup From Enable

($V_{IN} = 20V$, $V_{OUT} = 12V$, $I_{OUT} = 300mA$)

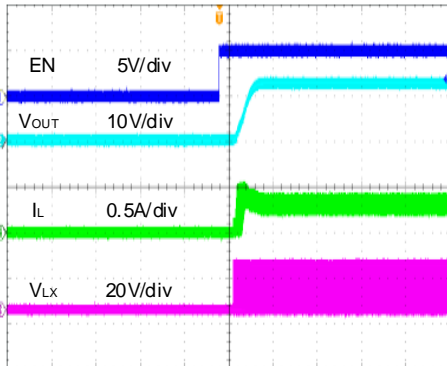

Time (800 μ s/div)

Shutdown From Enable

($V_{IN} = 20V$, $V_{OUT} = 12V$, $I_{OUT} = 300mA$)

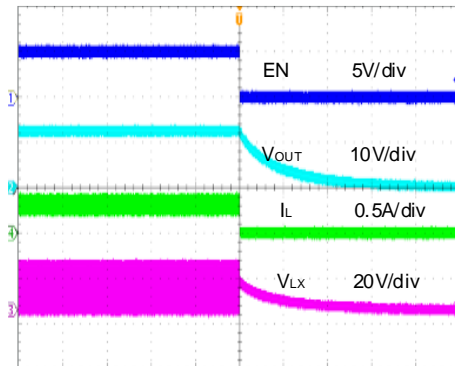

Time (200 μ s/div)

Bode Plot

($V_{IN} = 48V$, $V_{OUT} = 12V$, $I_{OUT} = 300mA$)

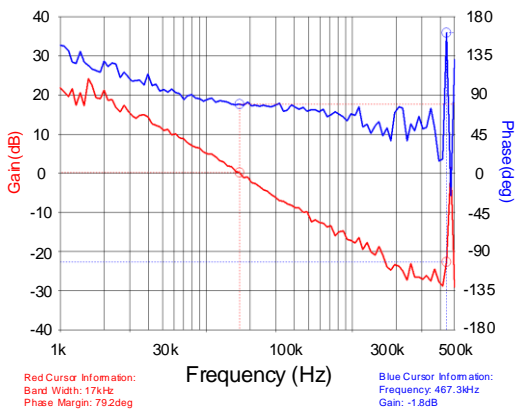

Bode Plot

($V_{IN} = 48V$, $V_{OUT} = 5V$, $I_{OUT} = 300mA$)

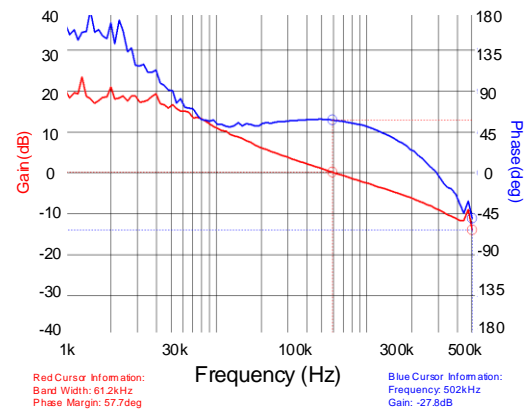

Detailed Description

The SY21019 high-efficiency asynchronous Buck converter can deliver 300mA output current over a wide input voltage range from 5V to 40V. It integrates a power FET with low $R_{DS(ON)}$ to minimize conduction loss.

The 2MHz switching frequency permits low output-voltage ripple and reduces external inductor and capacitor sizes. The SY21019 also provides cycle-by-cycle current limiting, over temperature protection and output short-circuit protection

The SY21019 employs a constant-off-time and peak-current-mode control strategy. When the power FET's current-sense signal reaches internal V_{COMP} , the power FET turns off for a fixed period of time (constant t_{OFF}). t_{OFF} is internally calculated according to the input voltage, output voltage, and desired switching frequency (f_{SW}):

$$t_{OFF} = \frac{1 - V_{OUT}/V_{IN}}{f_{SW}}$$

The power FET turns on after a period of t_{OFF} .

Enable Control

The EN input is a high-voltage capable input with logic-compatible threshold. When EN is driven higher than 1.5V, normal device operation is enabled. When driven to lower than 0.4V, the device will shut down, reducing input current to less than 10 μ A.

Fault-Protection Modes

Output Current Limit

With load current increasing, as soon as the power FET current exceeds the peak current-limit threshold, the power FET will turn off. If the load current continues to increase, the output voltage will drop.

Overtemperature Protection (OTP)

The device includes overtemperature protection (OTP) circuitry to prevent overheating due to excessive power dissipation. This will shut down the device when the junction temperature exceeds 150°C. Once the junction temperature cools by approximately 15°C, the device will resume normal operation after a complete soft-start cycle. For continuous operation, provide adequate cooling so

that the junction temperature does not exceed the OTP threshold.

Application Information

The following paragraphs describe the selection process for the feedback resistors (R_H and R_L), input capacitor C_{IN} , output inductor L , output capacitor C_{OUT} , bootstrap capacitor and rectifier diode D .

Feedback Resistor-Divider R_H and R_L

Choose R_H and R_L to program the proper output voltage. Choose large resistance values between 10k Ω and 1M Ω for both R_H and R_L to minimize power consumption under light loads. If V_{OUT} is 5V, a value of 100k Ω is chosen for R_H , then using the following equation, R_L can be calculated as 13.7k Ω :

$$R_L = \frac{0.6V}{V_{OUT}-0.6V} R_H$$

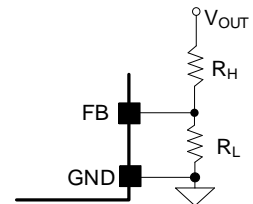

Input Capacitor C_{IN}

For the best performance, select a typical X5R or better grade ceramic capacitor with a 50V rating and at least 1 μ F capacitance. The capacitor should be placed as close as possible to the device, while also minimizing the loop area formed by C_{IN} and the IN/GND pins.

When selecting an input capacitor, ensure that its voltage rating is at least 20% greater than the maximum voltage of the input supply. X5R or X7R dielectric types are the most often selected due to their small size, low cost, surge current capability, and high RMS current rating over a wide temperature and voltage range.

In situations where the input rail is supplied through long wires, it is recommended to add some bulk capacitance like electrolytic, tantalum or polymer type capacitors to reduce the overshoot and ringing caused by the added parasitic inductance.

Consider the RMS current rating of the input capacitor, paralleling additional capacitors if required to meet the calculated RMS ripple current.

$$I_{CIN_RMS} = I_{OUT} \times \sqrt{D \times (1 - D)}$$

The worst-case condition occurs at $D = 0.5$, then

$$I_{CIN_RMS,MAX} = \frac{I_{OUT}}{2}$$

For simplicity, use an input capacitor with an RMS current rating greater than 50% of the maximum load current.

The input capacitor value determines the input voltage ripple of the converter. If there is a voltage ripple requirement in the system, choose an appropriate input capacitor that meets the specification.

Given the very low ESR and ESL of ceramic capacitors, the input voltage ripple can be estimated using the formula:

$$V_{CIN_RIPPLE,CAP} = \frac{I_{OUT}}{f_{SW} \times C_{IN}} \times D \times (1 - D)$$

The worst-case condition occurs at $D = 0.5$, then

$$V_{CIN_RIPPLE,CAP,MAX} = \frac{I_{OUT}}{4 \times f_{SW} \times C_{IN}}$$

The capacitance value is less important than the RMS current rating. A single $1\mu F$ X5R capacitor is sufficient in most applications.

Output Inductor L

Consider the following when choosing this inductor:

- 1) Choose the inductance to provide a ripple current that is approximately 40% of the maximum output current. The recommended inductance is calculated as:

$$L = \frac{V_{OUT}(1 - V_{OUT}/V_{IN,MAX})}{f_{SW} \times I_{OUT,MAX} \times 0.4}$$

where f_{SW} is the switching frequency and $I_{OUT,MAX}$ is the maximum load current.

The SY21019 has high tolerance for ripple current amplitude variation. As a result, the final choice of

inductance can vary slightly from the calculated value with no significant performance impact.

- 2) The inductor's saturation current rating must be greater than the peak inductor current under full load:

$$I_{SAT,MIN} > I_{OUT,MAX} + \frac{V_{OUT}(1 - V_{OUT}/V_{IN,MAX})}{2 \times f_{SW} \times L}$$

- 3) The DCR of the inductor and the core loss at the switching frequency must be low enough to achieve the desired efficiency requirement. Choose an inductor with DCR less than $50m\Omega$ to achieve good overall efficiency.

Output Capacitor C_{OUT}

Select the output capacitor C_{OUT} to handle the output ripple requirements. Both steady state ripple and transient requirements must be taken into consideration when selecting the component. For the best performance, use an X5R or better grade ceramic capacitor with a 25V rating and capacitance greater than $4.7\mu F$.

For applications where the design must meet stringent ripple requirements, the following considerations must be followed:

The output voltage ripple at the switching frequency is caused by the inductor current ripple (ΔI_L) on the output capacitor's ESR (ESR ripple), as well as the stored charge (capacitive ripple).

When calculating total ripple, consider both.

$$V_{RIPPLE,ESR} = \Delta I_L \times ESR$$

$$V_{RIPPLE,CAP} = \frac{\Delta I_L}{8 \times C_{OUT} \times f_{SW}}$$

The capacitive ripple might be higher because the effective capacitance for ceramic capacitors decreases with the voltage across the terminals. The voltage derating is usually included as a chart in the capacitor datasheet, and the ripple can be recalculated after taking the target output voltage into account.

External Bootstrap Capacitor

This external bootstrap capacitor provides the gate driver voltage for internal power MOSFET. A $0.1\mu\text{F}$ low-ESR ceramic capacitor connected between the BS pin and the LX pin is recommended.

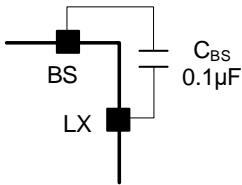

Rectifier Diode

To accommodate the device high switching speed, choose a Schottky diode with low forward voltage and fast switching speed. The diode's voltage rating must be higher than the Buck converter maximum input voltage, and the diode's average and peak current rating should be greater than the Buck converter output average current and peak current.

Load Transient Consideration

The device integrates the compensation components to achieve good stability and fast transient responses. In some applications, adding a small ceramic capacitor in parallel with R_H may further speed up the load transient response. It is recommended for applications with large load transient step requirements.

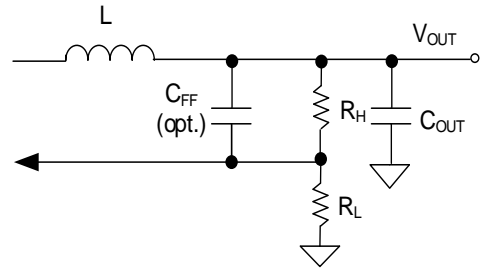

Application Schematic ($V_{OUT} = 12V$)

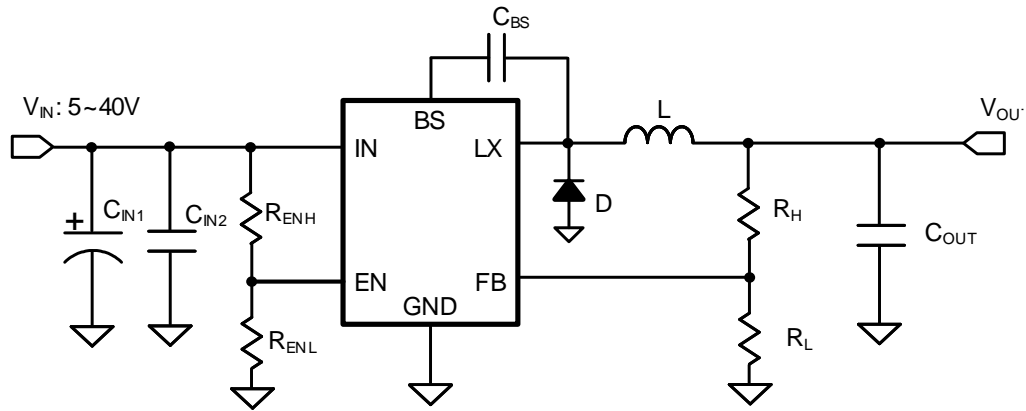

BOM List

Reference Designator	Description	Part Number	Manufacturer
C _{IN1}	47μF/50V (electrolytic capacitor)		
C _{IN2}	2.2μF/50V, 1206, X7R	C3216X7R1H225K	TDK
C _{OUT}	4.7μF/25V, 1206, X7R	C3216X7R1E475K	TDK
C _{BS}	100nF/50V, 0603, X7R	C1608X7R1H104K	TDK
L	22μH	VLP4045LT-220M	TDK
D	1A/50V, Schottky	SS15	
R _H	100kΩ, 1%, 0603		
R _L	5.23kΩ, 1%, 0603		
R _{ENH}	10kΩ, 1%, 0603		
R _{ENL}	1MΩ, 1%, 0603		

Recommended Component Values for Typical Applications

V _{OUT} (V)	R _H (kΩ)	R _L (kΩ)	L/Part Number	C _{OUT}
3.3	100	22.1	4.7μH/VLP4045LT-4R7M	4.7μF/25V, 1206, X7R
5	100	13.7	10μH/VLP4045LT-100M	4.7μF/25V, 1206, X7R
12	100	5.23	22μH/VLP4045LT-220M	4.7μF/25V, 1206, X7R

Layout Design

Follow these PCB layout guidelines for optimal performance and thermal dissipation:

- Input Capacitors:** Place the input capacitors close to the IN and GND pins, minimizing the loop formed by these connections. The input capacitor should be connected to the IN and GND using wide copper areas.
- Output Capacitors:** Connect the C_{OUT} negative terminal to the GND pin using wide copper traces instead of vias, in order to achieve better accuracy and stability of output voltage.
- Feedback Network:** Place the feedback components (R_H , R_L , and C_{FF}) as close to the FB pin as possible. Avoid routing the feedback line near LX, or other high-frequency signals as it is noise-sensitive. Use a Kelvin connection to connect with C_{OUT} rather than the inductor output terminal.
- LX Connection:** Keep the LX area small to prevent excessive EMI, while providing a wide copper area to minimize parasitic resistance and inductance.
- EN Signal:** It is not recommended to connect EN signal directly to V_{IN} . A resistor in a range of $1k\Omega$ to $1M\Omega$ should be used if the lines are pulled high to V_{IN} .
- GND Vias:** Place an adequate number of vias on the GND layer around the device for better thermal performance. The exposed GND pad should be connected to a copper area larger than its size. Place multiple GND vias on it for heat dissipation.
- PCB Board:** To achieve the best thermal and noise performance, maximize the PCB copper area connecting to the GND pin. A ground plane is highly recommended if board space allows. Connect the ground pad to a large copper area to enhance thermal performance.

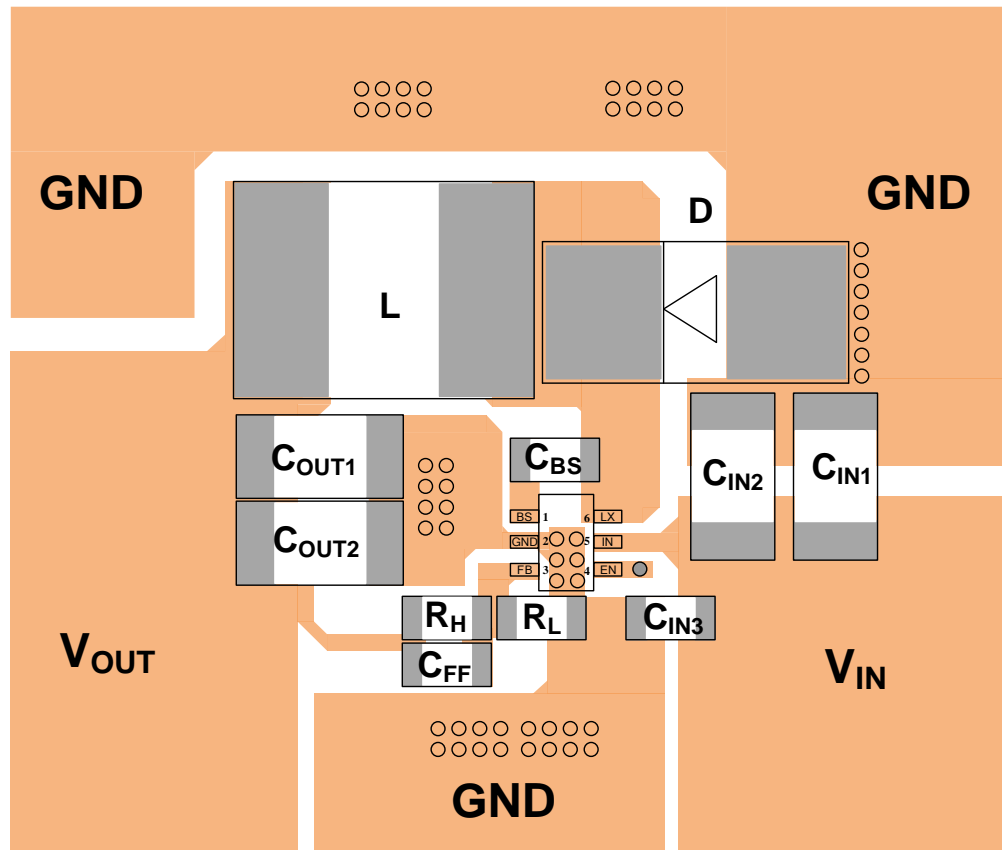
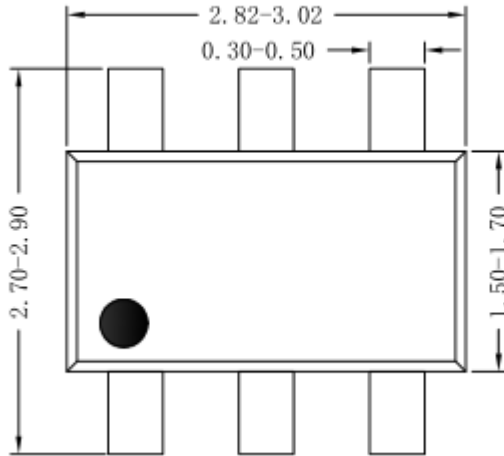
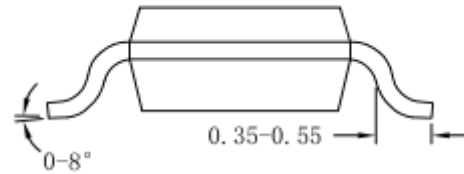

Figure 4. Suggested PCB Layout

SOT23-6 Package Outline and PCB Layout



Top view



Side view

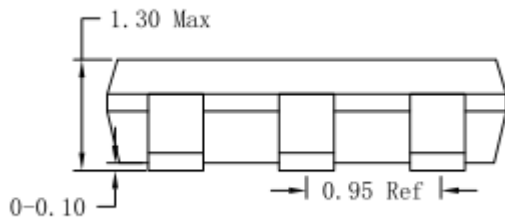

Side view

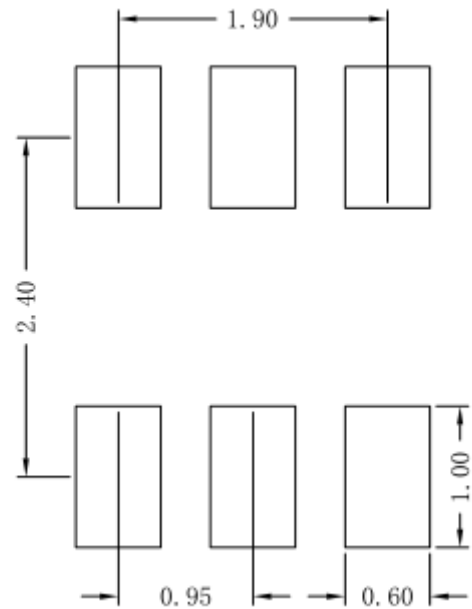

Recommended pad layout
(reference only)

Note: All dimensions are in millimeters and exclude mold flash and metal burr.

Taping and Reel Specification

SOT23-6 taping orientation

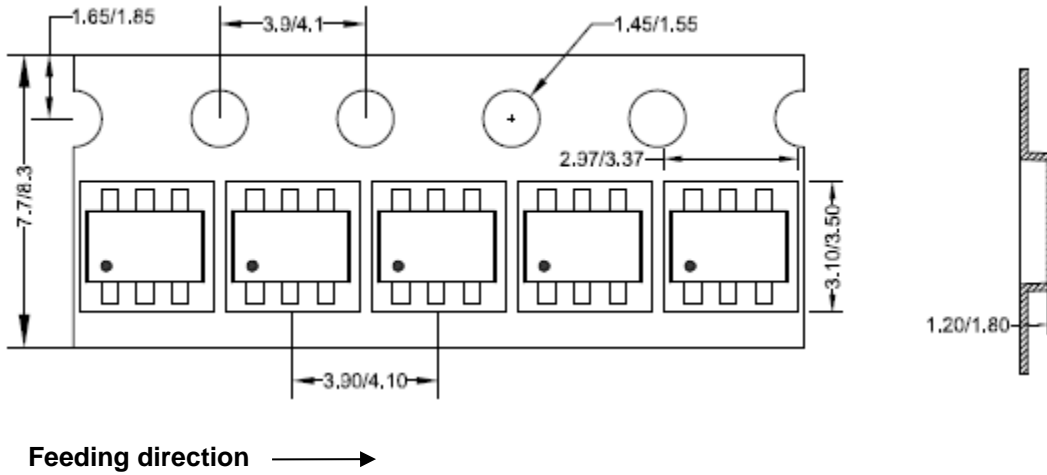

Carrier tape and reel specification for packages

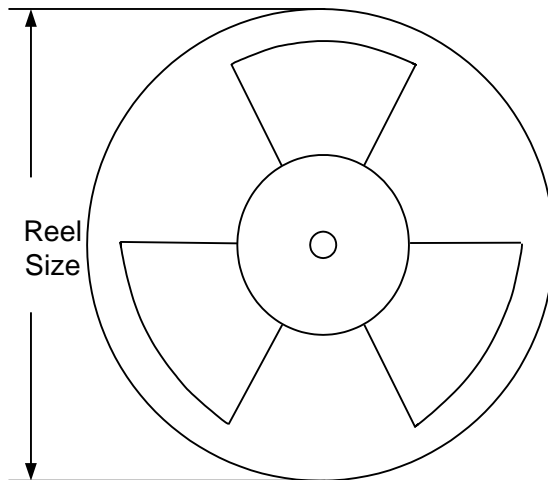

Package types	Tape width (mm)	Pocket pitch(mm)	Reel size (Inch)	Trailer length(mm)	Leader length (mm)	Qty per reel
SOT23-6	8	4	7"	280	160	3000

Others: NA

Revision History

The revision history provided is for informational purposes only and is believed to be accurate, however, not warranted. Please make sure that you have the latest revision.

Date	Revision	Change
Aug.30, 2023	Revision 1.0	Language improvements for clarity.
Mar.22, 2018	Revision 0.9A	Update in "Package Outline & PCB Layout":

IMPORTANT NOTICE

1. **Right to make changes.** Silergy and its subsidiaries (hereafter Silergy) reserve the right to change any information published in this document, including but not limited to circuitry, specification and/or product design, manufacturing or descriptions, at any time and without notice. This document supersedes and replaces all information supplied prior to the publication hereof. Buyers should obtain the latest relevant information before placing orders and should verify that such information is current and complete. All semiconductor products are sold subject to Silergy's standard terms and conditions of sale.
2. **Applications.** Application examples that are described herein for any of these products are for illustrative purposes only. Silergy makes no representation or warranty that such applications will be suitable for the specified use without further testing or modification. Buyers are responsible for the design and operation of their applications and products using Silergy products. Silergy or its subsidiaries assume no liability for any application assistance or designs of customer products. It is customer's sole responsibility to determine whether the Silergy product is suitable and fit for the customer's applications and products planned. To minimize the risks associated with customer's products and applications, customer should provide adequate design and operating safeguards. Customer represents and agrees that it has all the necessary expertise to create and implement safeguards which anticipate dangerous consequences of failures, monitor failures and their consequences, lessen the likelihood of failures that might cause harm and take appropriate remedial actions. Silergy assumes no liability related to any default, damage, costs or problem in the customer's applications or products, or the application or use by customer's third-party buyers. Customer will fully indemnify Silergy, its subsidiaries, and their representatives against any damages arising out of the use of any Silergy components in safety-critical applications. It is also buyers' sole responsibility to warrant and guarantee that any intellectual property rights of a third party are not infringed upon when integrating Silergy products into any application. Silergy assumes no responsibility for any said applications or for any use of any circuitry other than circuitry entirely embodied in a Silergy product.
3. **Limited warranty and liability.** Information furnished by Silergy in this document is believed to be accurate and reliable. However, Silergy makes no representation or warranty, expressed or implied, as to the accuracy or completeness of such information and shall have no liability for the consequences of use of such information. In no event shall Silergy be liable for any indirect, incidental, punitive, special or consequential damages, including but not limited to lost profits, lost savings, business interruption, costs related to the removal or replacement of any products or rework charges, whether or not such damages are based on tort or negligence, warranty, breach of contract or any other legal theory. Notwithstanding any damages that customer might incur for any reason whatsoever, Silergy' aggregate and cumulative liability towards customer for the products described herein shall be limited in accordance with the Standard Terms and Conditions of Sale of Silergy.
4. **Suitability for use.** Customer acknowledges and agrees that it is solely responsible for compliance with all legal, regulatory and safety-related requirements concerning its products, and any use of Silergy components in its applications, notwithstanding any applications-related information or support that may be provided by Silergy. Silergy products are not designed, authorized or warranted to be suitable for use in life support, life-critical or safety-critical systems or equipment, nor in applications where failure or malfunction of an Silergy product can reasonably be expected to result in personal injury, death or severe property or environmental damage. Silergy assumes no liability for inclusion and/or use of Silergy products in such equipment or applications and therefore such inclusion and/or use is at the customer's own risk.
5. **Terms and conditions of commercial sale.** Silergy products are sold subject to the standard terms and conditions of commercial sale, as published at <http://www.silergy.com/stdterms>, unless otherwise agreed in a valid written individual agreement specifically agreed to in writing by an authorized officer of Silergy. In case an individual agreement is concluded only the terms and conditions of the respective agreement shall apply. Silergy hereby expressly objects to and denies the application of any customer's general terms and conditions with regard to the purchase of Silergy products by the customer.
6. **No offer to sell or license.** Nothing in this document may be interpreted or construed as an offer to sell products that is open for acceptance or the grant, conveyance or implication of any license under any copyrights, patents or other industrial or intellectual property rights. Silergy makes no representation or warranty that any license, either express or implied, is granted under any patent right, copyright, mask work right, or other intellectual property right. Information published by Silergy regarding third-party products or services does not constitute a license to use such products or services or a warranty or endorsement thereof. Use of such information may require a license from a third party under the patents or other intellectual property of the third party, or a license from Silergy under the patents or other intellectual property of Silergy.

For more information, please visit: www.silergy.com

©2021 Silergy Corp.

All Rights Reserved.

X-ON Electronics

Largest Supplier of Electrical and Electronic Components

Click to view similar products for [Switching Voltage Regulators](#) category:

Click to view products by [Silergy](#) manufacturer:

Other Similar products are found below :

[FAN53610AUC33X](#) [FAN53611AUC123X](#) [EN6310QA](#) [160215](#) [R3](#) [KE177614](#) [FAN53611AUC12X](#) [MAX809TTR](#) [NCV891234MW50R2G](#)
[AST1S31PUR](#) [NCP81203PMNTXG](#) [NCP81208MNTXG](#) [NCP81109GMNTXG](#) [NCP3235MNTXG](#) [NCP81109JMNTXG](#) [MP2161AGJ-Z](#)
[NCP81241MNTXG](#) [NTE7223](#) [NTE7222](#) [NTE7224](#) [L6986FTR](#) [MPQ4481GU-AEC1-P](#) [MP8756GD-P](#) [MPQ2171GJ-P](#) [MPQ2171GJ-AEC1-P](#)
[N JW4153U2-A-TE2](#) [MP2171GJ-P](#) [MP28160GC-Z](#) [MPM3509GQVE-AEC1-P](#) [XDPE132G5CG000XUMA1](#) [LM60440AQRPKRQ1](#)
[MP5461GC-P](#) [NCV896530MWATXG](#) [MPQ4409GQBE-AEC1-P](#) [S-19903DA-A8T1U7](#) [S-19903CA-A6T8U7](#) [S-19903CA-S8T1U7](#) [S-](#)
[19902BA-A6T8U7](#) [S-19902CA-A6T8U7](#) [S-19932BA-A6T8U7](#) [S-19932AA-A6T8U7](#) [S-19932BA-A8T1U7](#) [S-19902AA-A6T8U7](#) [S-](#)
[19903AA-A6T8U7](#) [S-19902AA-S8T1U7](#) [S-19902BA-A8T1U7](#) [AU8310](#) [LMR33630APAQRN XRQ1](#) [LMR33630APCQRN XRQ1](#)
[LMR54406DBVR](#)