

### General Description

The SY21314 high efficiency step-up regulator operates using current mode control over a wide input voltage range from 3V to 33V. It integrates an N-channel MOSFET with low 120mΩ  $R_{DS(ON)}$  to minimize conduction loss.

The 1MHz switching frequency and internal compensation reduce external inductor and capacitor sizes, and the built-in internal soft-start circuitry minimizes inrush current at startup.

The device offers overcurrent and thermal shutdown protections.

The SY21314 is available in a compact DFN3x3-10 package.

### Features

- 3V to 33V Input Voltage Range
- 33V Maximum Output Voltage
- 4A Main MOSFET Current Limit
- 15  $\mu$ A Shutdown Current (Max.)
- 100  $\mu$ A Quiescent Current (Typ.)
- Low  $R_{DS(ON)}$  for Internal N-Channel MOSFET: 120mΩ
- 1MHz Switching Frequency
- Internal Soft-Start
- $\pm 2\%$  0.6V Reference
- Cycle-by-Cycle Peak Current Limit
- Overtemperature Protection
- RoHS-Compliant and Halogen-Free
- Compact DFN3mmx3mm-10 Package

### Applications

- Portable Devices
- Battery Powered Systems
- Networking Cards Powered from PCI or PCI-Express Slots

### Typical Application

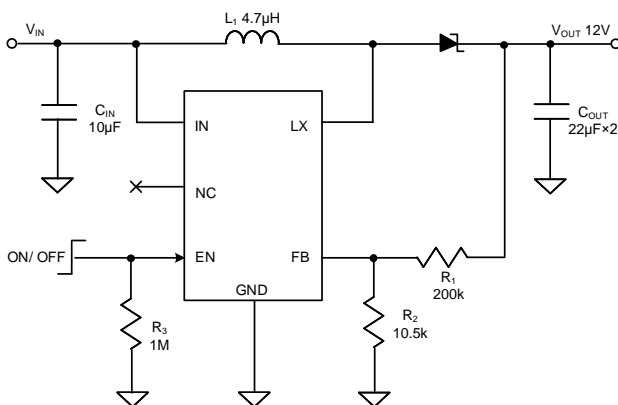

Figure 1. Typical Application Circuit

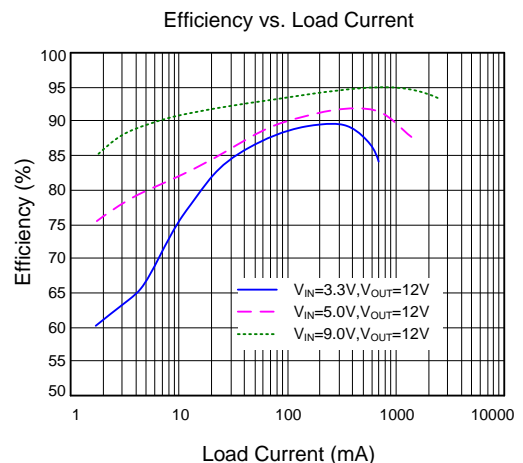

Figure 2. Efficiency vs. Output Current



### Ordering Information

Ordering Part Number	Package Type	Top Mark
SY21314DBC	DFN3x3-10 RoHS-Compliant and Halogen-Free	Vlxyz

x = year code, y = week code, z = lot number code

### Pinout (top view)

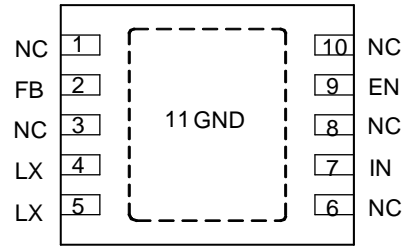

### Pin Description

Pin Number	Pin Name	Pin Description
1,3,6,8,10	NC	No connection.
2	FB	Feedback pin. Connect a resistor R1 between V <sub>OUT</sub> and FB, and a resistor R2 between FB and GND to program the output voltage: $V_{OUT} = 0.6V \times (R1/R2+1)$ .
4,5	LX	Inductor node. Connect an inductor between the IN and LX pins.
7	IN	Input pin. Decouple this pin to the GND pin with a 1μF ceramic capacitor.
9	EN	Enable pin. Drive low to disable the device, drive high to enable. Do not leave floating.
11	GND	Ground pin. Connect to system GND.

### Block Diagram

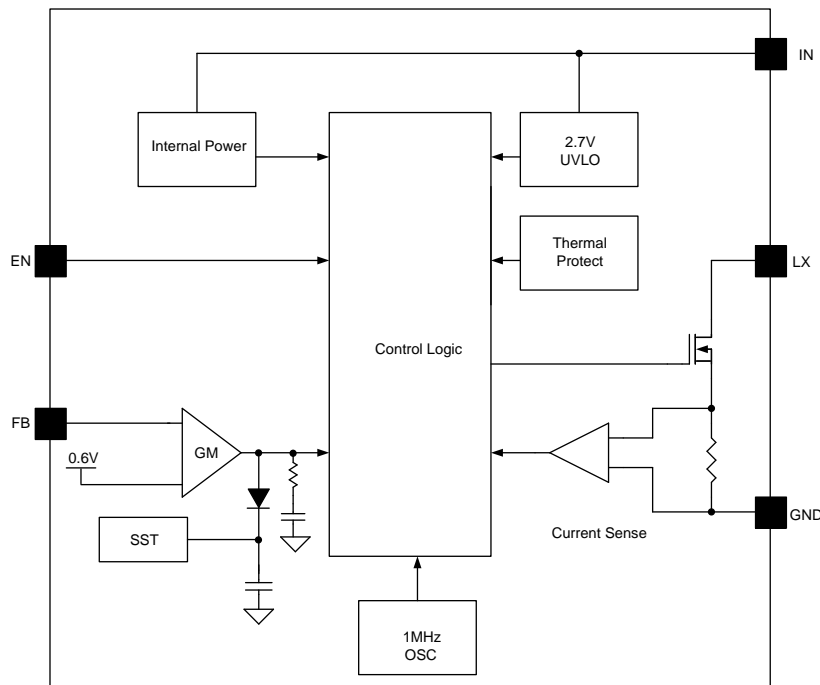

## Absolute Maximum Ratings

Parameter (Note1)	Min	Max	Unit
LX, IN, EN	-0.3	36	V
FB	-0.3	4	
LX, 50ns Duration	IN+3	GND-4	
Lead Temperature (Soldering, 10 sec.)		260	°C
Junction Temperature, Operating	-40	150	
Storage Temperature	-65	150	

## Thermal Information

Parameter (Note2)	Typ	Unit
$\theta_{JA}$ Junction-to-ambient Thermal Resistance	38	°C/W
$\theta_{JC}$ Junction-to-case Thermal Resistance	8	
$P_D$ Power Dissipation $T_A=25^\circ\text{C}$	2.6	W

## Recommended Operating Conditions

Parameter (Note3)	Min	Max	Unit
IN	3	33	V
Junction Temperature, Operating	-40	125	°C
Ambient Temperature	-40	85	

## Electrical Characteristics

( $V_{IN} = 5V$ ,  $V_{OUT} = 12V$ ,  $I_{OUT} = 100mA$ ,  $T_A = 25^\circ C$  unless otherwise specified)

Parameter	Symbol	Test Conditions	Min	Typ	Max	Unit
Input Voltage Range	$V_{IN}$		3		33	V
Quiescent Current	$I_Q$	$V_{FB} = 0.66V$		100		$\mu A$
Shutdown Current	$I_{SHDN}$	$EN = 0$			15	$\mu A$
Low Side Main FET $R_{ON}$	$R_{DS(ON)}$			120		m $\Omega$
Main FET Current Limit	$I_{LIM}$	Duty cycle = 80%	4		6	A
Switching Frequency	$f_{SW}$		0.8	1	1.2	MHz
Feedback Reference Voltage	$V_{REF}$		0.588	0.6	0.612	V
FB Pin Input Current	$I_{FB}$		-50		50	nA
IN UVLO Rising Threshold	$V_{IN,UVLO}$				2.7	V
UVLO Hysteresis	$U_{VLO,HYS}$			0.1		V
EN Rising Threshold	$V_{ENH}$		2			V
EN Falling Threshold	$V_{ENL}$				0.4	V
Maximum Duty Cycle	$D_{MAX}$			90		%
Thermal Shutdown Temperature	$T_{SD}$			150		$^\circ C$
Thermal Recovery Hysteresis	$T_{HYS}$			15		$^\circ C$

**Note 1:** Stresses beyond the “Absolute Maximum Ratings” may cause permanent damage to the device. These are stress ratings only. Functional operation of the device at these or any other conditions beyond those indicated in the operational sections of the specification is not implied. Exposure to absolute maximum rating conditions for extended periods may affect device reliability.

**Note 2:**  $\theta_{JA}$  is measured in the natural convection at  $T_A = 25^\circ C$  on a low effective single layer thermal conductivity test board of JEDEC 51-3 thermal measurement standard. Test condition: Device mounted on 2” x 2” FR-4 substrate PCB, 2oz copper, with minimum recommended pad on top layer and thermal vias to bottom layer ground plane.

**Note 3:** The device is not guaranteed to function outside its operating conditions.

## Typical Performance Characteristics

( $T_A = 25^\circ\text{C}$ ,  $V_{IN} = 5\text{V}$ ,  $V_{OUT} = 12\text{V}$ ,  $L = 2.2\mu\text{H}$ ,  $C_{OUT} = 44\mu\text{F}$ , unless otherwise specified.)

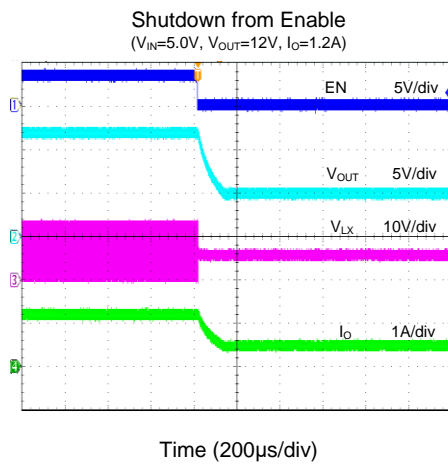
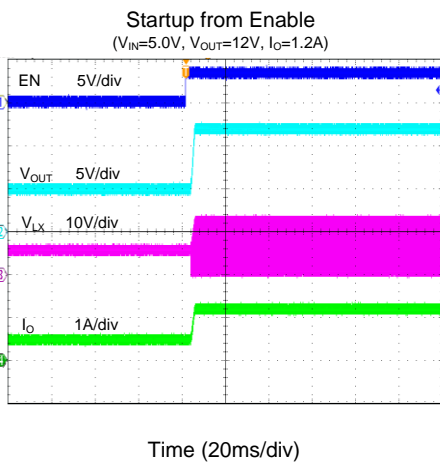
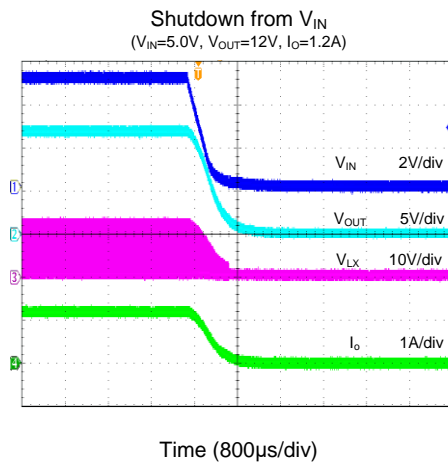
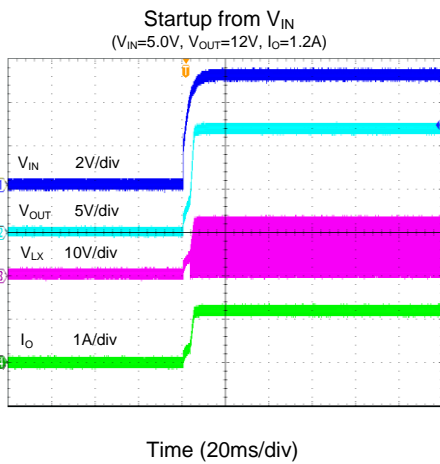
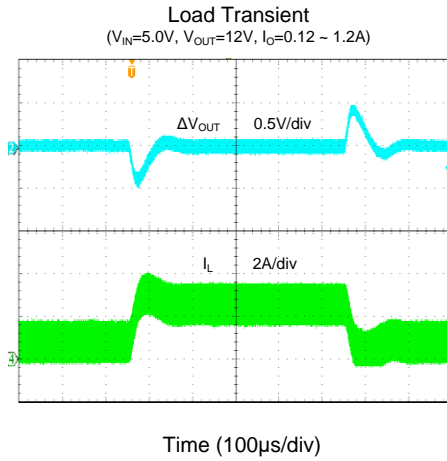
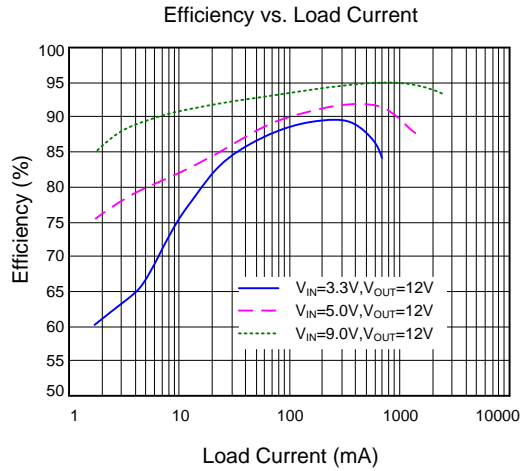

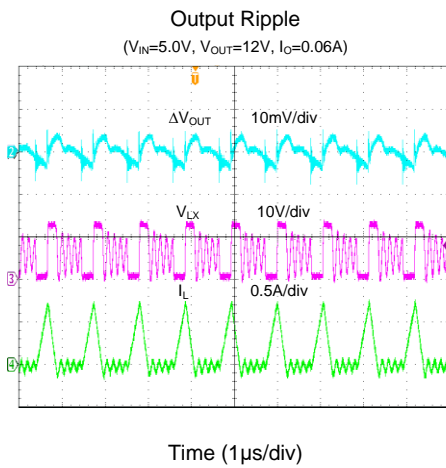
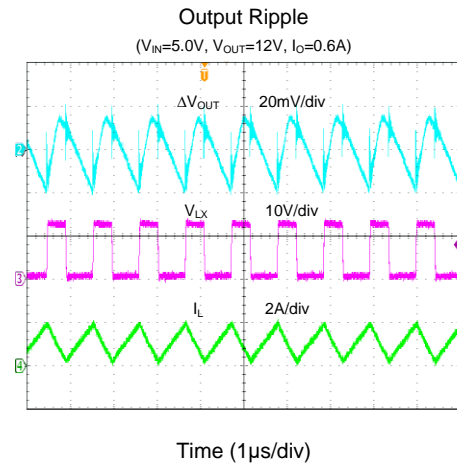
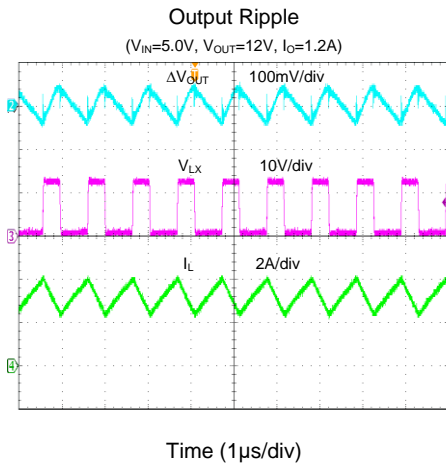

## Detailed Description

The SY21314 high efficiency step-up regulator operates using current mode control, over a wide input voltage range from 3V to 33V. It integrates an N-channel MOSFET with low 120mΩ  $R_{DS(ON)}$  to minimize conduction loss.

The 1MHz switching frequency and internal compensation reduce external inductor and capacitor sizes, and the built-in internal soft-start circuitry minimizes inrush current at startup.

### Enable Operation

Driving the EN pin high (>2V) enables normal operation. Driving the EN pin low (<0.4V) places the device in shutdown mode. During shutdown mode, the SY21314 current drops to less than 15μA.

### Soft-Start (EN Control)

The SY21314 has a built-in soft-start to control the rising slew rate of the output voltage and limit the input current surge during IC startup. With a 200μs turn-on delay time before the initial soft-start, the typical soft-start time is 1ms.

## Application Information

The following paragraphs describe the selection process for the feedback resistors (R1 and R2), input capacitor  $C_{IN}$ , output capacitor  $C_{OUT}$ , boost inductor L, and diode D.

### Feedback Resistor-Divider R1 and R2

Choose R1 and R2 to program the proper output voltage. Choose large resistance values between 10kΩ and 1MΩ for both R1 and R2 to minimize power consumption under light loads. If a value of 200kΩ is chosen for R1, then R2 can be calculated as:

$$R2 = \frac{0.6V}{V_{OUT}-0.6V} R1$$

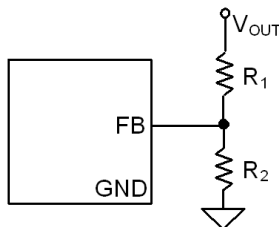

### Input Capacitor $C_{IN}$

Input filter capacitors reduce the ripple voltage on the input, filter the switched current drawn from the input supply, and

reduce the EMI. When selecting an input capacitor, be sure to select a voltage rating at least 20% greater than the maximum voltage of the input supply and a temperature rating higher than the system requirements. X5R series ceramic capacitors are most often selected due to their small size, low cost, surge-current capability, and high RMS current ratings over a wide temperature and voltage range. However, systems that are powered by a wall adapter or other long and therefore inductive cabling may be susceptible to significant inductive ringing at the input to the device. In these cases, consider adding some bulk capacitance like electrolytic, tantalum, or polymer type capacitors. Using a combination of bulk capacitors (to reduce overshoot or ringing) in parallel with ceramic capacitors (to meet the RMS current requirements) is helpful in these cases.

Consider the RMS current rating of the input capacitor, paralleling additional capacitors if required to meet the calculated RMS ripple current.

$$I_{CIN\_RMS} = \frac{V_{IN} \cdot (V_{OUT} - V_{IN})}{2\sqrt{3} \cdot L \cdot F_{SW} \cdot V_{OUT}}$$

For the best performance, select a typical X5R or better grade low ESR 10μF ceramic capacitor and place it as close as possible to the IN and GND pins. Take care to minimize the loop area formed by  $C_{IN}$  and the IN/GND pins.

### Output Capacitor $C_{OUT}$

Select the output capacitor  $C_{OUT}$  to handle the output ripple requirements. Both steady state ripple and transient requirements must be taken into consideration when selecting the component. For the best performance, use an X5R or better grade ceramic capacitor with capacitance of at least 22μF.

For applications where the design must meet stringent ripple requirements, the following considerations must be followed:

The output voltage ripple at the switching frequency is caused by the inductor current ripple ( $\Delta I_L$ ) on the output capacitor's ESR (ESR ripple), as well as the stored charge (capacitive ripple). When calculating total ripple, both should be considered.

$$V_{RIPPLE, ESR1} = I_{LPEAK} \times ESR$$

$$V_{RIPPLE, ESR2} = I_{LVALLEY} \times ESR$$

$$V_{RIPPLE, CAP} = \frac{I_{OUT} \times (1-D)}{C_{OUT} \times f_{SW}}$$

The measured capacitive ripple might be higher than the calculated value because the effective capacitance for ceramic capacitors decreases with the voltage across the terminals. The voltage derating is usually included as a chart in the capacitor datasheet, and the ripple can be recalculated after taking the target output voltage into account.

### Boost Inductor L

Consider the following when choosing this inductor:

- 1) Choose the inductance to provide a ripple current that is approximately 40% of the maximum output current. The recommended inductance is calculated as:

$$L = \left( \frac{V_{IN}}{V_{OUT}} \right)^2 \frac{V_{OUT} - V_{IN}}{f_{SW} I_{OUT,MAX} \times 0.4}$$

where  $f_{SW}$  is the switching frequency and  $I_{OUT,MAX}$  is the maximum load current.

The SY21314 has high tolerance for ripple current amplitude variation. As a result, the final choice of inductance can vary slightly from the calculated value with no significant performance impact.

- 2) The inductor's saturation current rating must be greater than the peak inductor current under full load:

$$I_{SAT,MIN} = \left( \frac{V_{OUT}}{V_{IN}} \right) \times I_{OUT,MAX} + \frac{V_{IN}(V_{OUT} - V_{IN})}{2 \times f_{SW} \times L \times V_{OUT}}$$

- 3) The DCR of the inductor and the core loss at the switching frequency must be low enough to achieve the desired efficiency requirement. Choose an inductor with DCR less than 10mΩ to achieve good overall efficiency.

### Rectifier Diode

For high efficiency, choose a Schottky diode with low forward voltage drop and fast reverse recovery. The maximum current rating of the diode must be higher than the maximum input current, and the average current rating of the diode must be higher than the output current. The reverse breakdown voltage must be higher than the maximum output voltage.

### Maximum Output Current Estimation

The maximum current that the converter can provide to the load depends on the output voltage / input voltage ratio.

Use the following formulas to evaluate an approximate max current that the converter can deliver when driving the load.

$$D = 1 - V_{IN(MIN)} \times \frac{\eta}{V_{OUT}}$$

Estimate the maximum output current:

$$I_{MAXOUT} = \left( I_{L,MIN} - \frac{\Delta I_L}{2} \right) \times \frac{\eta \times V_{IN(MIN)}}{V_{OUT}}$$

$$I_{MAXOUT} = \left( I_{LIM(MIN)} - \frac{\Delta I_L}{2} \right) \times (1-D)$$

Where:  $V_{IN(MIN)}$  is the minimum voltage at the boost input in the application,  $I_{L,MIN}$  is the minimum device current datasheet limit (4A for SY21314),  $\Delta I_L$  is the current ripple and  $\eta$  is the efficiency, which can be substituted with a value of 0.8 for simplicity.

### Thermal Protection

The SY21314 includes over temperature protection circuitry to prevent overheating due to excessive power dissipation. This will shut down the device when the junction temperature exceeds 150°C. When the junction temperature cools down by approximately 15°C, the device will resume normal operation after a complete soft-start cycle. For continuous operation, provide adequate cooling so that the junction temperature does not exceed the thermal protection threshold.

### Over Current Protection

The SY21314 provides a cycle-by-cycle overcurrent protection and turns off the main power MOSFET once the inductor current reaches the overcurrent limit threshold. During the overcurrent protection, the output voltage drops as a function of the load. If the output voltage drops below the input voltage, the current will directly flow through L and rectifier diode. In this case the current is only limited by the DC resistance in the path during the event. As soon as the overload condition is removed, the converter resumes operation.



## Application Schematic

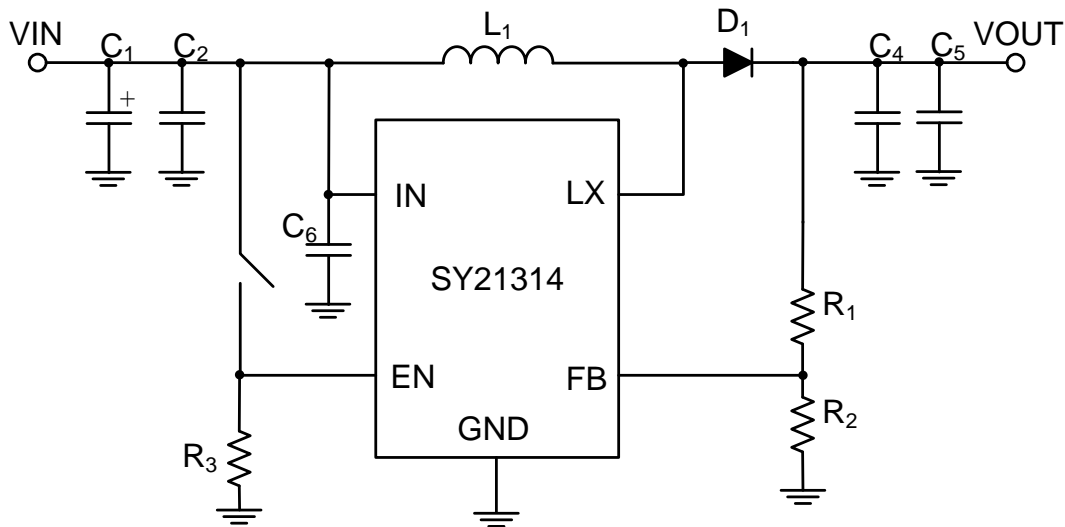

## Design Specifications

Input Voltage (V)	Output Voltage(V)	Output Current Limit (A)
3-12	12	1.2

## BOM List

Reference Designator	Description	Part Number	Manufacturer
U1	4A, 1MHz Sync Boost(DFN3X3-10)	SY21314DBC	Silergy
L1	2.2 $\mu$ H/6A inductor	VLP6045LT-2R2N	TDK
C1	47 $\mu$ F/50V(electrolytic capacitor)		
C2, C4, C5	22 $\mu$ F/25V, 1206, X5R	C3216X5R1E226M	TDK
C6	0.1 $\mu$ F/25V, 0603, X5R	GRM188R61E104K	muRata
D1	5A Schottky diode	SS54	
R1	200k, 1%, 0603		
R2	10.5k, 1%, 0603		
R3	1M $\Omega$ , 0603		

## Recommend Components for Typical Applications

V <sub>out</sub> (V)	R1(k $\Omega$ )	R2(k $\Omega$ )	L( $\mu$ H)	C3
12	200	10.5	2.2	2 $\times$ 22 $\mu$ F/25V/X7R, 1206

## Layout Design

To achieve optimal design, follow these PCB layout considerations:

- Place  $C_{IN}$ , L, R1, and R2 close to the IC
- To achieve the best thermal and noise performance, maximize the PCB copper area connecting to the GND pin. A ground plane is highly recommended if cost allows.
- $C_{IN}$  must be close to pins IN and GND. Minimize the loop area formed by  $C_{OUT}$ , LX, and GND.

- To reduce the switching noise, minimize the PCB copper area connected to the LX pin.
- In order to reduce crosstalk, R1, R2, and the trace connected to the FB pin must not be adjacent to the LX net on the PCB layout.
- If the system controller interfacing with the EN pin has a high impedance state during shutdown mode, and the IN pin is connected directly to a power source such as a Li-ion battery, add a 1M $\Omega$  pulldown resistor between the EN and GND pins to prevent noise from falsely triggering the regulator during shutdown mode.

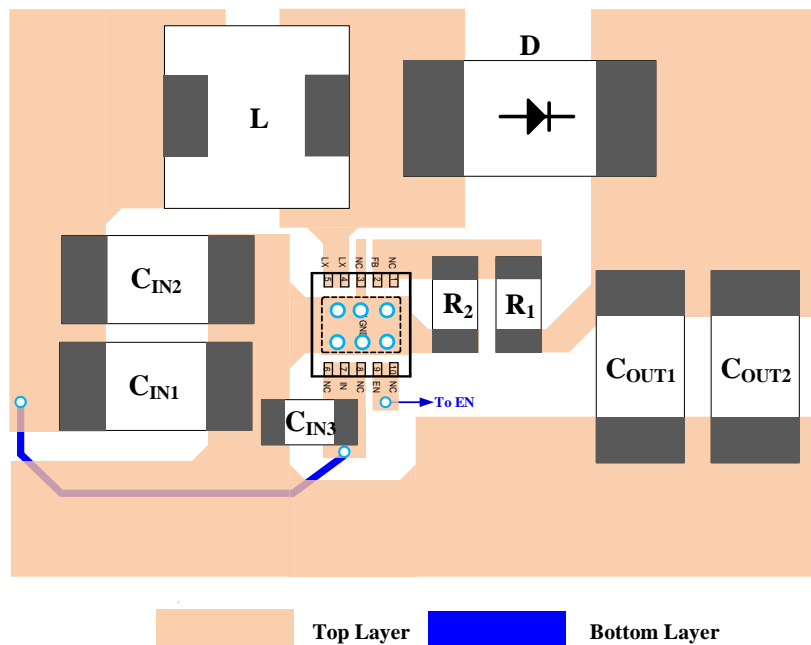
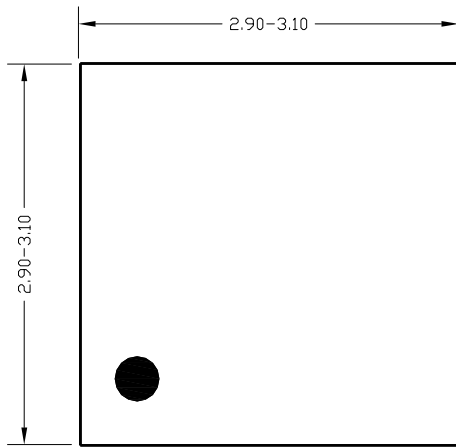
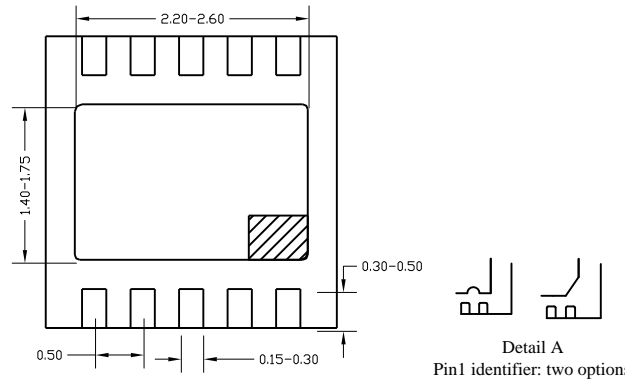

Figure 4. Suggested PCB Layout

**DFN3x3-10 Package Outline and PCB Layout**



**Top view**



**Bottom view**

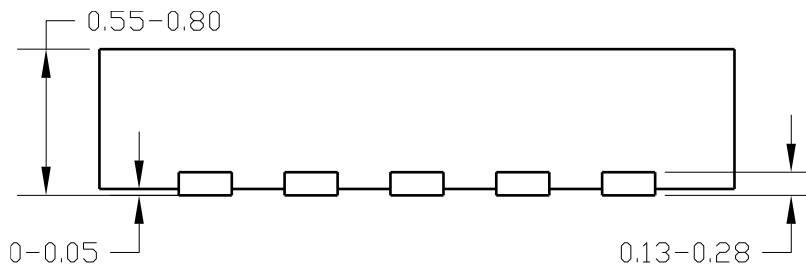

**Side view**

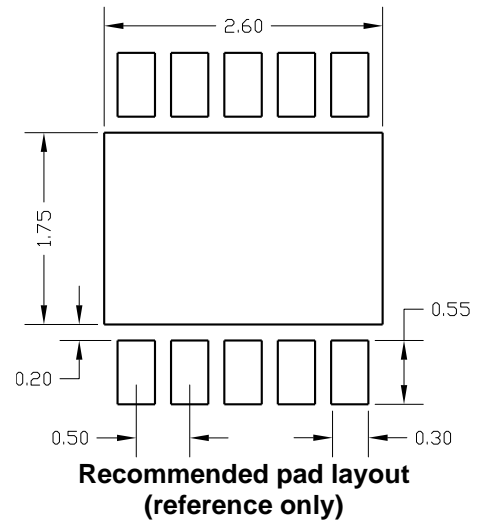

**Recommended pad layout  
(reference only)**

**Note:** All dimensions are in millimeters and exclude mold flash and metal burr.

## Taping and Reel Specification

### DFN3x3-10 taping orientation

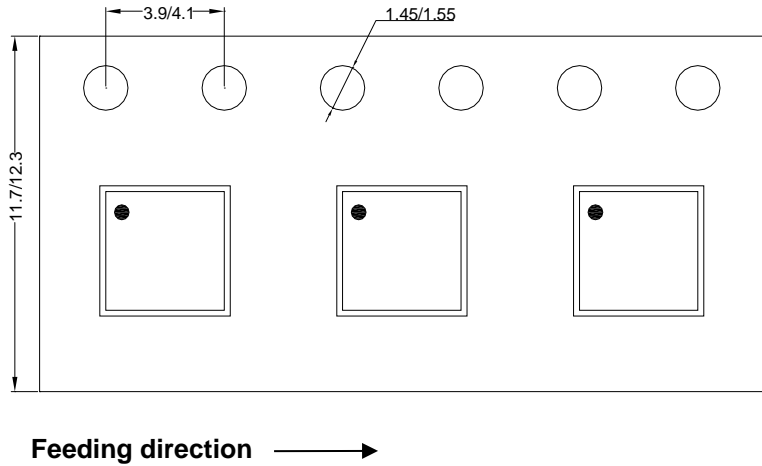

### Carrier tape and reel specification for packages

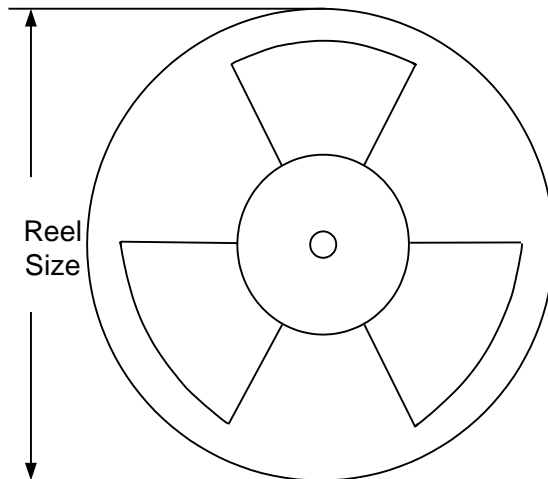

Package types	Tape width (mm)	Pocket pitch(mm)	Reel size (Inch)	Trailer length(mm)	Leader length (mm)	Qty per reel
DFN3x3	10	8	13"	400	400	5000

Others: NA

## Revision History

The revision history provided is for informational purposes only and is believed to be accurate, however, not warranted. Please make sure that you have the latest revision.

Date	Revision	Change
Apr.20, 2023	Revision 1.0	Language improvements for clarity.
Sep.27, 2013	Revision 0.9	Initial Release

**IMPORTANT NOTICE**

1. **Right to make changes.** Silergy and its subsidiaries (hereafter Silergy) reserve the right to change any information published in this document, including but not limited to circuitry, specification and/or product design, manufacturing or descriptions, at any time and without notice. This document supersedes and replaces all information supplied prior to the publication hereof. Buyers should obtain the latest relevant information before placing orders and should verify that such information is current and complete. All semiconductor products are sold subject to Silergy's standard terms and conditions of sale.
2. **Applications.** Application examples that are described herein for any of these products are for illustrative purposes only. Silergy makes no representation or warranty that such applications will be suitable for the specified use without further testing or modification. Buyers are responsible for the design and operation of their applications and products using Silergy products. Silergy or its subsidiaries assume no liability for any application assistance or designs of customer products. It is customer's sole responsibility to determine whether the Silergy product is suitable and fit for the customer's applications and products planned. To minimize the risks associated with customer's products and applications, customer should provide adequate design and operating safeguards. Customer represents and agrees that it has all the necessary expertise to create and implement safeguards which anticipate dangerous consequences of failures, monitor failures and their consequences, lessen the likelihood of failures that might cause harm and take appropriate remedial actions. Silergy assumes no liability related to any default, damage, costs or problem in the customer's applications or products, or the application or use by customer's third-party buyers. Customer will fully indemnify Silergy, its subsidiaries, and their representatives against any damages arising out of the use of any Silergy components in safety-critical applications. It is also buyers' sole responsibility to warrant and guarantee that any intellectual property rights of a third party are not infringed upon when integrating Silergy products into any application. Silergy assumes no responsibility for any said applications or for any use of any circuitry other than circuitry entirely embodied in a Silergy product.
3. **Limited warranty and liability.** Information furnished by Silergy in this document is believed to be accurate and reliable. However, Silergy makes no representation or warranty, expressed or implied, as to the accuracy or completeness of such information and shall have no liability for the consequences of use of such information. In no event shall Silergy be liable for any indirect, incidental, punitive, special or consequential damages, including but not limited to lost profits, lost savings, business interruption, costs related to the removal or replacement of any products or rework charges, whether or not such damages are based on tort or negligence, warranty, breach of contract or any other legal theory. Notwithstanding any damages that customer might incur for any reason whatsoever, Silergy' aggregate and cumulative liability towards customer for the products described herein shall be limited in accordance with the Standard Terms and Conditions of Sale of Silergy.
4. **Suitability for use.** Customer acknowledges and agrees that it is solely responsible for compliance with all legal, regulatory and safety-related requirements concerning its products, and any use of Silergy components in its applications, notwithstanding any applications-related information or support that may be provided by Silergy. Silergy products are not designed, authorized or warranted to be suitable for use in life support, life-critical or safety-critical systems or equipment, nor in applications where failure or malfunction of a Silergy product can reasonably be expected to result in personal injury, death or severe property or environmental damage. Silergy assumes no liability for inclusion and/or use of Silergy products in such equipment or applications and therefore such inclusion and/or use is at the customer's own risk.
5. **Terms and conditions of commercial sale.** Silergy products are sold subject to the standard terms and conditions of commercial sale, as published at <http://www.silergy.com/stdterms>, unless otherwise agreed in a valid written individual agreement specifically agreed to in writing by an authorized officer of Silergy. In case an individual agreement is concluded only the terms and conditions of the respective agreement shall apply. Silergy hereby expressly objects to and denies the application of any customer's general terms and conditions with regard to the purchase of Silergy products by the customer.
6. **No offer to sell or license.** Nothing in this document may be interpreted or construed as an offer to sell products that is open for acceptance or the grant, conveyance or implication of any license under any copyrights, patents or other industrial or intellectual property rights. Silergy makes no representation or warranty that any license, either express or implied, is granted under any patent right, copyright, mask work right, or other intellectual property right. Information published by Silergy regarding third-party products or services does not constitute a license to use such products or services or a warranty or endorsement thereof. Use of such information may require a license from a third party under the patents or other intellectual property of the third party, or a license from Silergy under the patents or other intellectual property of Silergy.

For more information, please visit: [www.silergy.com](http://www.silergy.com)

© 2018 Silergy Corp.

**All Rights Reserved.**

## X-ON Electronics

Largest Supplier of Electrical and Electronic Components

*Click to view similar products for [Switching Voltage Regulators](#) category:*

*Click to view products by [Silergy](#) manufacturer:*

Other Similar products are found below :

[FAN53610AUC33X](#) [FAN53611AUC123X](#) [EN6310QA](#) [160215](#) [R3](#) [KE177614](#) [FAN53611AUC12X](#) [MAX809TTR](#) [NCV891234MW50R2G](#)  
[AST1S31PUR](#) [NCP81203PMNTXG](#) [NCP81208MNTXG](#) [NCP81109GMNTXG](#) [NCP3235MNTXG](#) [NCP81109JMNTXG](#) [MP2161AGJ-Z](#)  
[NCP81241MNTXG](#) [NTE7223](#) [NTE7222](#) [NTE7224](#) [L6986FTR](#) [MPQ4481GU-AEC1-P](#) [MP8756GD-P](#) [MPQ2171GJ-P](#) [MPQ2171GJ-AEC1-P](#)  
[N JW4153U2-A-TE2](#) [MP2171GJ-P](#) [MP28160GC-Z](#) [MPM3509GQVE-AEC1-P](#) [XDPE132G5CG000XUMA1](#) [LM60440AQRPKRQ1](#)  
[MP5461GC-P](#) [NCV896530MWATXG](#) [MPQ4409GQBE-AEC1-P](#) [S-19903DA-A8T1U7](#) [S-19903CA-A6T8U7](#) [S-19903CA-S8T1U7](#) [S-](#)  
[19902BA-A6T8U7](#) [S-19902CA-A6T8U7](#) [S-19932BA-A6T8U7](#) [S-19932AA-A6T8U7](#) [S-19932BA-A8T1U7](#) [S-19902AA-A6T8U7](#) [S-](#)  
[19903AA-A6T8U7](#) [S-19902AA-S8T1U7](#) [S-19902BA-A8T1U7](#) [AU8310](#) [LMR33630APAQRN XRQ1](#) [LMR33630APCQRN XRQ1](#)  
[LMR54406DBVR](#)