



# Application Note: SY6287C

## Low Loss Power Distribution Switch with Programmable Current limit

### General Description

SY6287C is an ultra-low  $R_{DS(ON)}$  power distribution switch with current limit to protect the power source from over current and short circuit conditions. It incorporates over temperature protection and reverse blocking function.

### Ordering Information

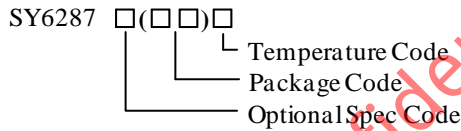

Ordering Number	Package Type	Note
SY6287CABC	SOT23-6	
SY6287CDEC	DFN2x2-6	

### Features

- Input Voltage: 2.5V to 5.5V
- Extremely Low Power Path Resistance: 65mΩ (Typ.)
- Adjustable Current Limit Up to 2.0A
- Over Temperature Shutdown and Automatic Retry
- Reverse Blocking (No Body Diode)
- Fault Flag (OCB) Output for Over Current and Fault Conditions
- Built-in Soft-start
- Compact Package Minimizes the Board Space: SOT23-6/DFN2x2-6

### Applications

- USB 3.1 Application
- USB 3G Data Card
- USB Dongle
- Mini PCI Accessories
- USB Charger
- Public Place Multi-USB Charger
- PC Card Hot Swap Applications

### Typical Application Circuit

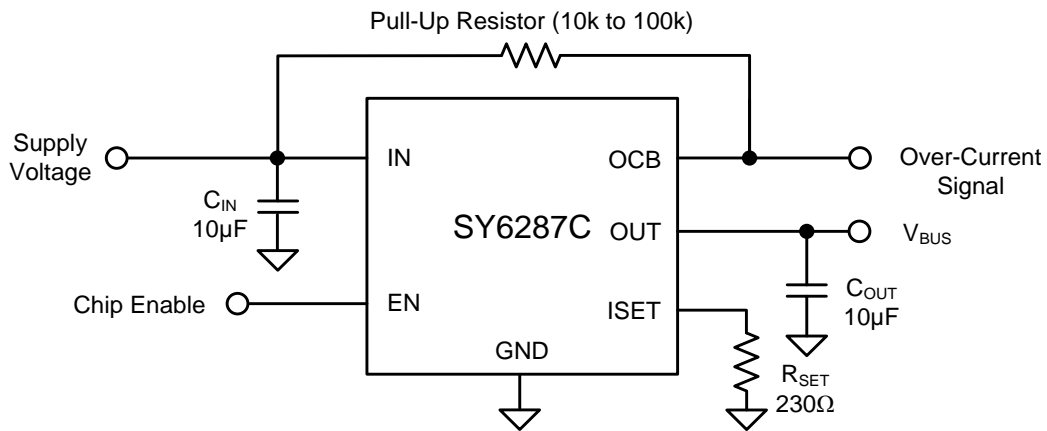

Note: If 1µF input cap will lead to large  $V_{in}$  voltage spike, it is strongly recommended to add additional 10 µF ceramic cap.

Figure1. Schematic Diagram

## Pinout (Top view)

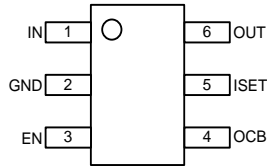

SY6287CABC, SOT23-6

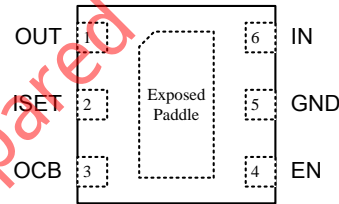

SY6287CDEC, DFN2x2-6

Part Number	Package Type	Top Mark <sup>①</sup>
SY6287CABC	SOT23-6	cLxyz
SY6287CDEC	DFN2x2-6	cMxyz

Note ①: x=year code, y=week code, z=lot number code.

Pin Name	Pin Number		Pin Description
	SY6287C SOT23-6	SY6287C DFN2x2-6	
IN	1	6	Input pin, decoupled with a 10 μF capacitor to GND.
GND	2	5, Exposed Paddle	Ground pin.
OUT	6	1	Output pin, decoupled with a 10 μF capacitor to GND.
EN	3	4	ON/OFF control, active high. Do not leave it floating.
ISET	5	2	Current limit programming pin. Connect a resistor $R_{SET}$ from this pin to ground to program the current limit: $I_{LIM} (A) = 230/R_{SET} (\Omega)$ .
OCB	4	3	Open drain fault flag.

## Block Diagram

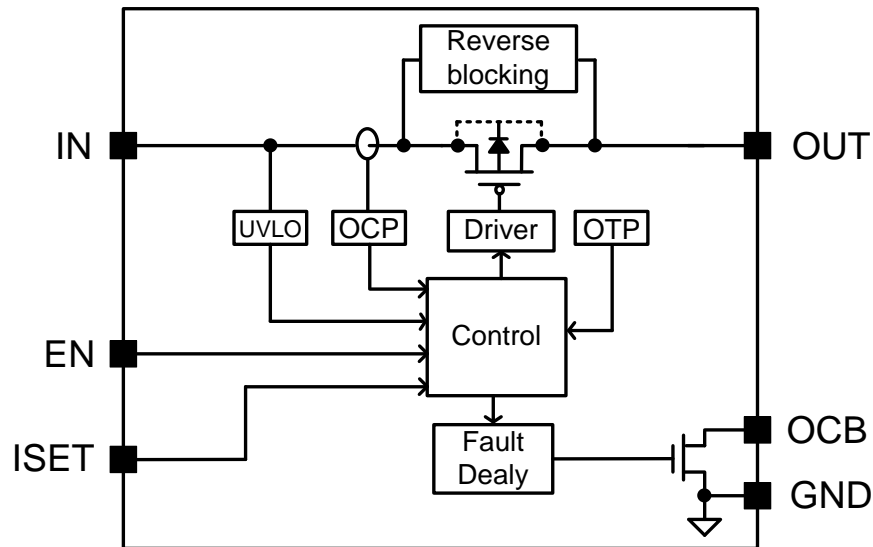

Figure2. Block Diagram

## Absolute Maximum Ratings (Note 1)

IN, OUT	-----	7V
ISET, OCB, EN	-----	7V
Power Dissipation, $P_D$ @ $T_A = 25\text{ }^\circ\text{C}$ SOT23-6/DFN2x2-6	-----	0.94W/1.53W
Package Thermal Resistance (Note 2)		
SOT23-6/DFN2x2-6, $\theta_{JA}$	-----	106.4 $^\circ\text{C/W}$ /65.3 $^\circ\text{C/W}$
SOT23-6/DFN2x2-6, $\theta_{JC}$	-----	41.7 $^\circ\text{C/W}$ /16.2 $^\circ\text{C/W}$
Junction Temperature	-----	150 $^\circ\text{C}$
Lead Temperature (Soldering, 10 sec.)	-----	260 $^\circ\text{C}$
Storage Temperature Range	-----	-65 $^\circ\text{C}$ to 150 $^\circ\text{C}$

## Recommended Operating Conditions (Note 3)

IN, OUT	-----	2.5V to 5.5V
All Other Pins	-----	0V to 5.5V
Junction Temperature Range	-----	-40 $^\circ\text{C}$ to 125 $^\circ\text{C}$
Ambient Temperature Range	-----	-40 $^\circ\text{C}$ to 85 $^\circ\text{C}$

## Electrical Characteristics

( $V_{IN} = 5\text{V}$ ,  $C_{OUT} = 10\text{ }\mu\text{F}$ ,  $T_A = 25\text{ }^\circ\text{C}$ , BOLD values indicate -40  $^\circ\text{C}$  to 85  $^\circ\text{C}$ , unless otherwise specified.)

Parameter	Symbol	Test Conditions	Min	Typ	Max	Unit
Input Voltage Range	$V_{IN}$		2.5		5.5	V
IN UVLO Threshold	$V_{IN,UVLO}$				2.45	V
IN UVLO Hysteresis	$V_{IN,HYS}$			0.1		V
Shutdown Input Current	$I_{SHDN}$	Open load, switch off		0.1	5	$\mu\text{A}$
		Output grounded, switch off		0.1	5	$\mu\text{A}$
Reverse Leakage Current		IN tie to GND, $V_{OUT} = 5\text{V}$		0.1	5	$\mu\text{A}$
Quiescent Supply Current	$I_Q$	Open load, switch on		45	100	$\mu\text{A}$
FET $R_{DS(ON)}$	$R_{DS(ON)}$	$V_{IN} = 5\text{V}$ , $I_{OUT} = 0.5\text{A}$		65	100	m $\Omega$
Current Limit Factor		$I_{OUT} = 0.5\text{A}$ , $V_{OUT} = 4\text{V}$ (Note5)	195.5	230	264.5	V
		$I_{OUT} = 1.5\text{A}$ , $V_{OUT} = 4\text{V}$ (Note5)	212	230	248	V
EN/ $\overline{\text{EN}}$ Threshold	Logic-low Voltage	$V_{IL}$			0.4	V
	Logic-high Voltage	$V_{IH}$	1.0			V
EN Input Cap	$C_{EN}$	(Note4)		1		pF
Output Turn On Time	$t_{ON}$	$R_L = 10\Omega$ , $C_L = 1\text{ }\mu\text{F}$ . Measure from EN ON to $V_{OUT}$ reach $V_{IN} \times 90\%$	1	2	5	ms
Output Turn On Rise Time	$t_R$	$R_L = 10\Omega$ , $C_L = 1\text{ }\mu\text{F}$ . Measure from $V_{OUT} = 10\%$ of $V_{IN}$ to 90% of $V_{IN}$	1	2	5	ms
Output Turn Off Time	$t_{OFF}$	$R_L = 10\Omega$ , $C_L = 1\text{ }\mu\text{F}$ . Measure from EN OFF to $V_{OUT}$ reach $V_{IN} \times 10\%$		22		$\mu\text{s}$
Output Turn Off Fall Time	$t_F$	$R_L = 10\Omega$ , $C_L = 1\text{ }\mu\text{F}$ . Measure from $V_{OUT} = 90\%$ of $V_{IN}$ to 10% of $V_{IN}$		21		$\mu\text{s}$
OCB Low Resistance	$R_{OCB}$	$V_{IN} = 5\text{V}$ , $I_L = 10\text{ }\mu\text{A}$		9		$\Omega$
		$V_{IN} = 3.3\text{V}$ , $I_L = 10\text{ }\mu\text{A}$		12		$\Omega$



# AN\_SY6287C

OCB Leakage Current	$I_{LKG\_OCB}$	$V_{OCB}=5V$		0.01	1	$\mu A$
Thermal Shutdown Temperature	$T_{SD}$			150		$^{\circ}C$
Thermal Shutdown Hysteresis	$T_{HYS}$			20		$^{\circ}C$
Current-limit Response Time	$t_{OC\_res}$	$V_{OUT}=0V$ (Note5)		25		$\mu s$
Over Current Flag Response Time	$t_{OCB}$	$V_{OUT}=V_{IN}/2$ to FLG low	4	8	12	$\mu s$

**Note 1:** Stresses beyond the “Absolute Maximum Ratings” may cause permanent damage to the device. These are stress ratings only. Functional operation of the device at these or any other conditions beyond those indicated in the operational sections of the specification is not implied. Exposure to absolute maximum rating conditions for extended periods may affect device reliability.

**Note 2:**  $\theta_{JA}$  is measured in the natural convection at  $T_A = 25^{\circ}C$  on a Silergy’s test board. Pin 2 of SOT23-6 packages is the case position for  $\theta_{JC}$  measurement.

**Note 3:** The device is not guaranteed to function outside its operating conditions.

**Note 4:** Guaranteed by design but not production tested.

**Note5:** Current limit threshold is determined by  $I_{LMT}=230V/R_{SET}$ , where  $R_{SET}$  is in ohms.

**Typical Performance Characteristic**

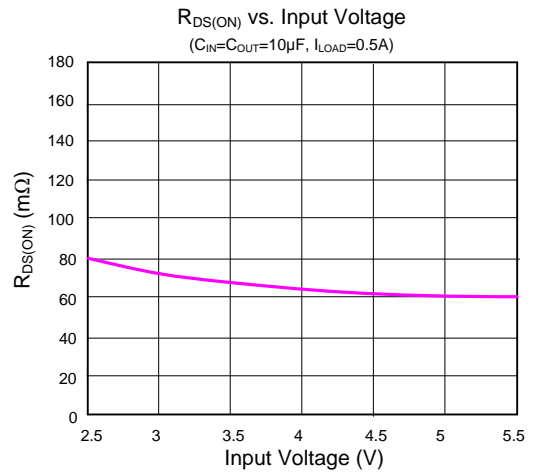
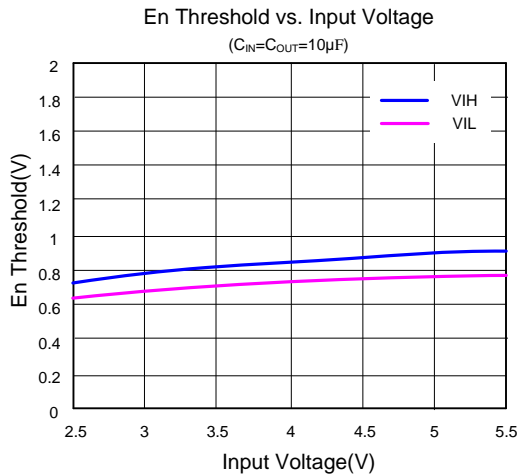
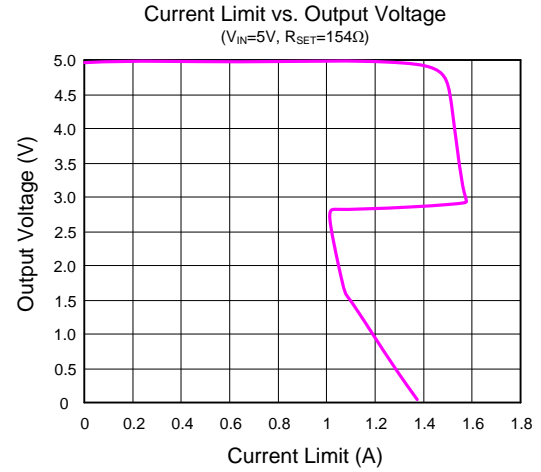
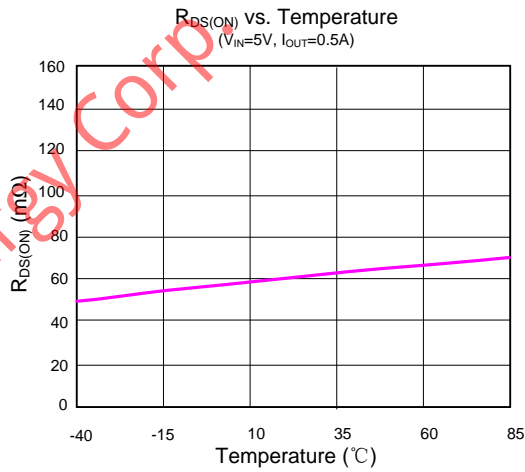
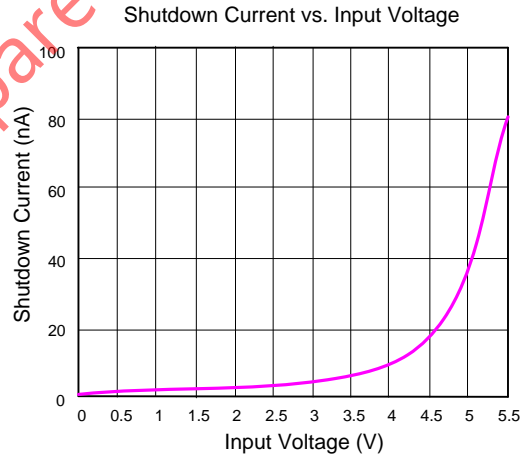
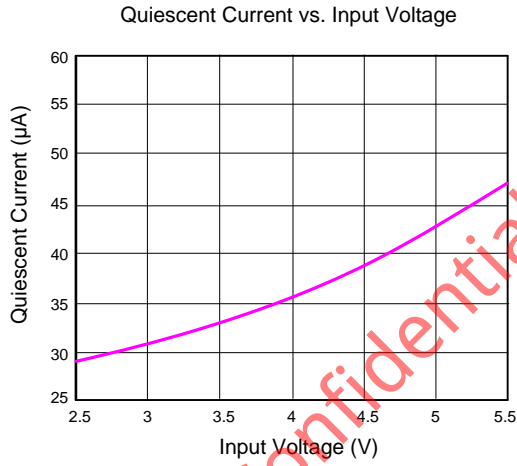

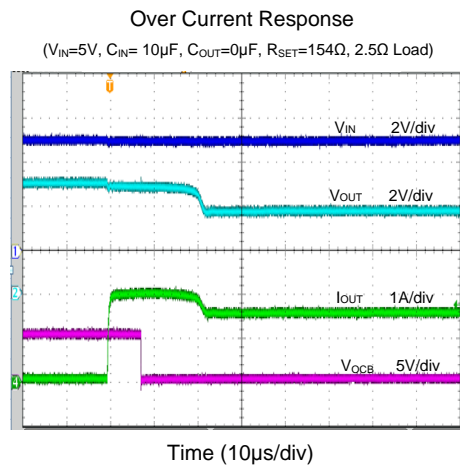
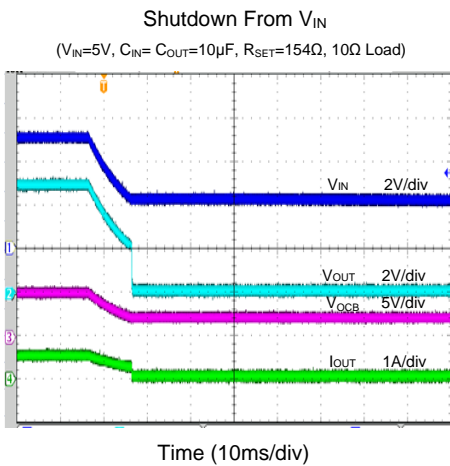
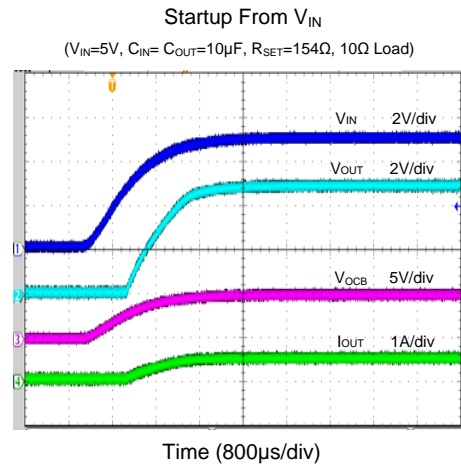
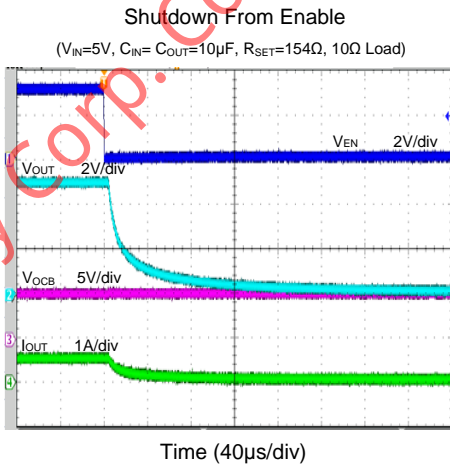
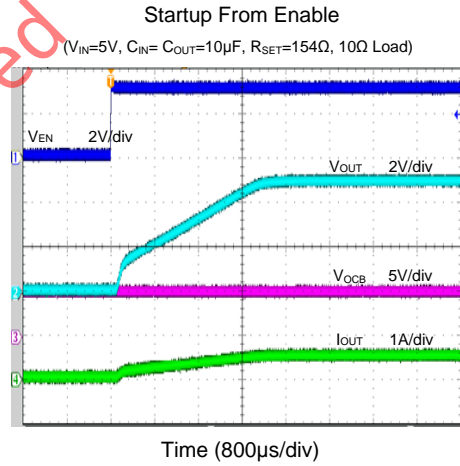
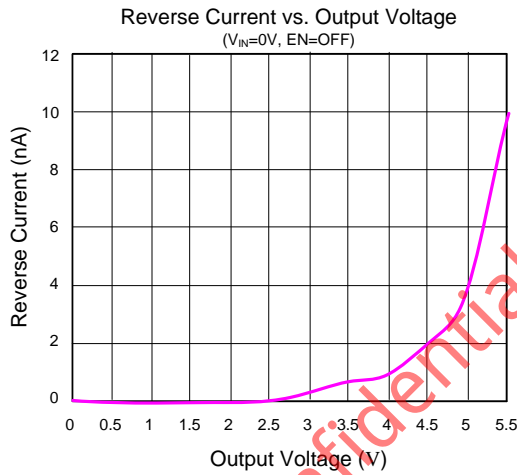

## Short Circuit Response

( $V_{IN}=5V$ ,  $C_{IN}=C_{OUT}=10\mu F$ )

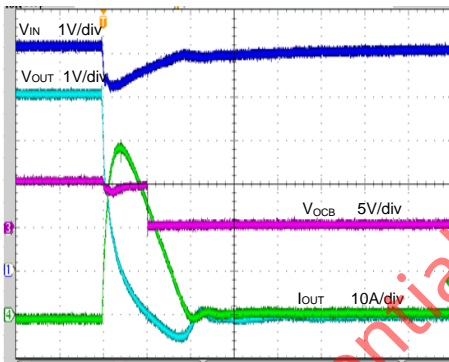

Time (10µs/div)

## Operation

The SY6287C is a current limited P-channel MOSFET power switch designed for USB load-switching or hot plug applications. It incorporates the over temperature protection and reverse blocking function, so the IC prevents current flow from OUT to IN when out being externally forced to a higher voltage than IN.

### Over Current Protection

The SY6287C supports Current limit programming. Connect a resistor  $R_{SET}$  from ISET pin to ground to program the current limit:

$$I_{LIM} (A) = 230 / R_{SET} (\Omega)$$

The minimum current limit is 0.2A. Current limit beyond 2.0A is not recommended.

When the over current condition is sensed, the gate of the pass switch is modulated to achieve constant output current. If the over current condition persists for a long time, the junction temperature may exceed 150 °C, and over-temperature protection will shut down the part. Once the chip temperature drops below 130 °C, the part will restart.

Table1. Current Limit vs.  $R_{SET}$

$R_{SET}(\Omega)$	Current Limit Threshold(mA)		
	MIN	TYP	MAX
460.0	425	500	575
153.3	1380	1500	1620

### Fault Flag(OCB)

The OCB output is asserted (active low) when Thermal shutdown protection is triggered or over current condition persists for 8 $\mu$ s. The output remains asserted until fault condition is removed. Connecting a heavy capacitance load to an enabled device can cause a momentary over current condition; However, no false reporting on OCB occurs due to 8 $\mu$ s deglitch circuit.

### Supply Filter Capacitor

In order to prevent the input voltage drooping during hot-plug events, a 10 $\mu$ F ceramic capacitor from VIN to GND is strongly recommended. However, higher capacitor values could reduce the voltage droop on the input further. Furthermore, an output short will cause ringing on the input without the input capacitor. It could destroy the internal circuitry when the input transient exceeds the absolute maximum supply voltage even for a short duration.

### Output Filter Capacitor

A 10 $\mu$ F output ceramic capacitor is recommended to be placed close to the IC and output connector to reduce voltage drop during load transient. Higher values of output capacitor can be used to further reduce the drop during high current application.

### Reverse Block Function:

The SY6287C integrates reverse block function. Once the deviation voltage of OUT-IN exceeds 100mV, the reverse block function is triggered. The power FET will be shutdown in 700ns block the reverse current flow from OUT to IN.

### PCB Layout Guide

For best performance of the SY6287C, the following guidelines must be strictly followed:

- 1) Keep all VBUS traces as short and wide as possible and use at least 2 ounce copper for all VBUS traces.
- 2) Locate the output capacitor as close to the connectors as possible to lower impedance (mainly inductance) between the port and the capacitor and improve transient performance.
- 3) Input and output capacitors should be placed closed to the IC and connected to ground plane to reduce noise coupling.



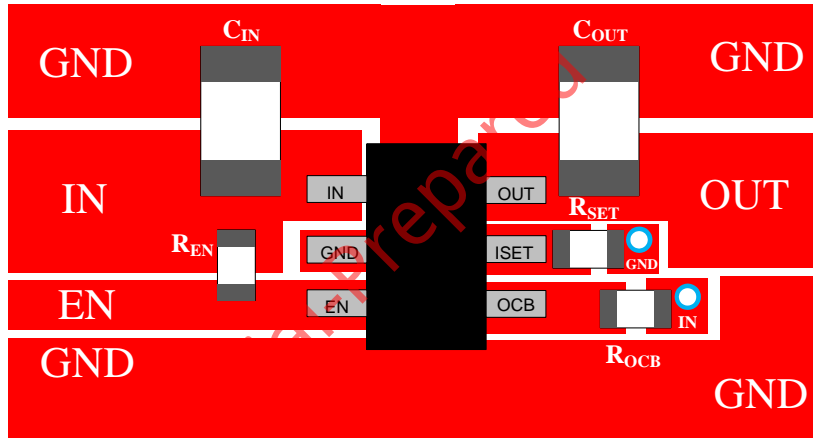

Figure3. SY6287CABC PCB Layout Suggestion

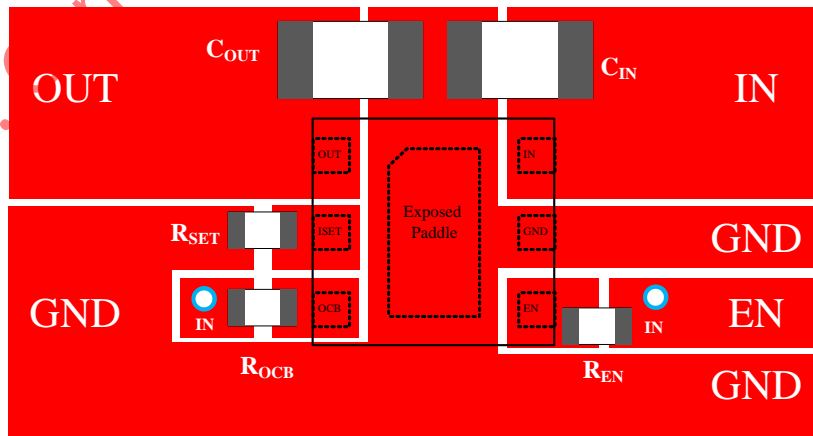
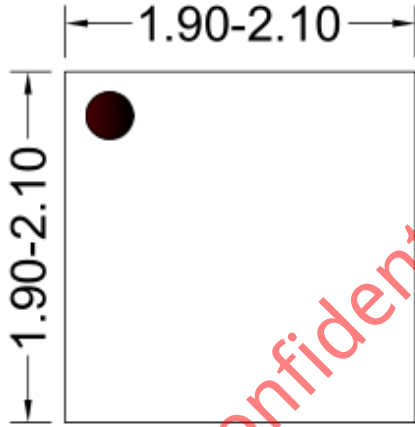

Figure4. SY6287CDEC PCB Layout Suggestion



**DFN2x2-6 Package Outline**



Top View

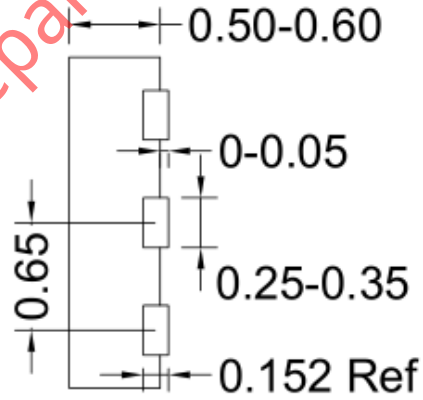

Side View

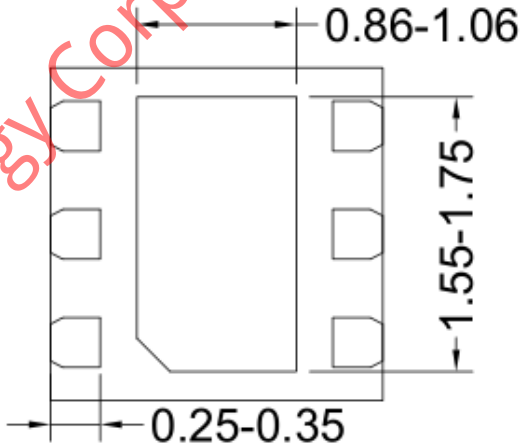

Bottom View

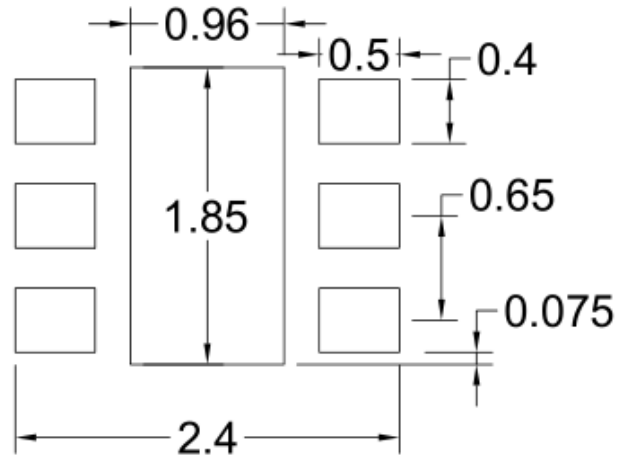

Recommended PCB layout

**Notes: All dimension in millimeter and exclude mold flash & metal burr**

## Taping & Reel Specification

### 1. Taping Orientation

SOT23-6

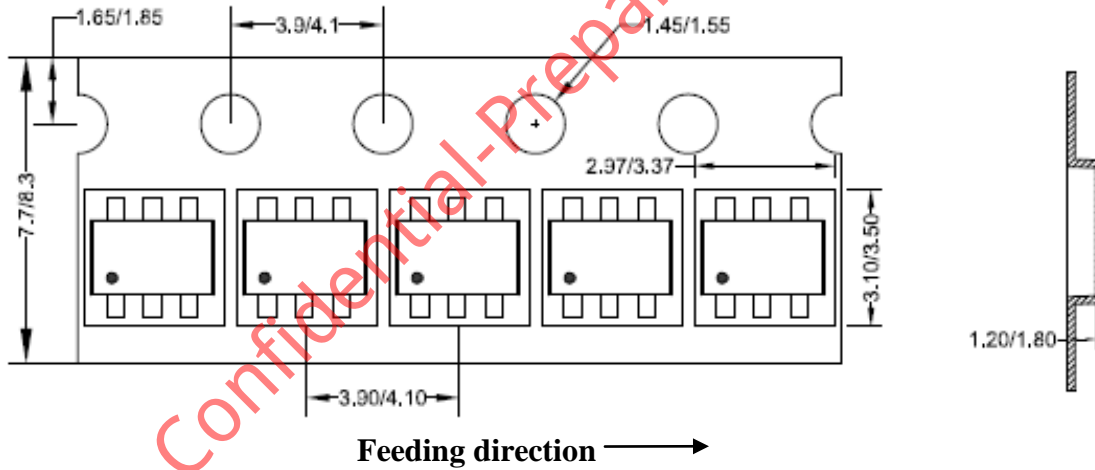

DFN2x2 taping orientation

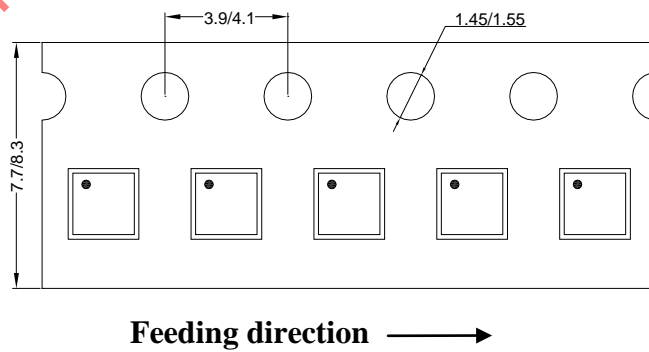

**2. Carrier Tape & Reel Specification for Packages**

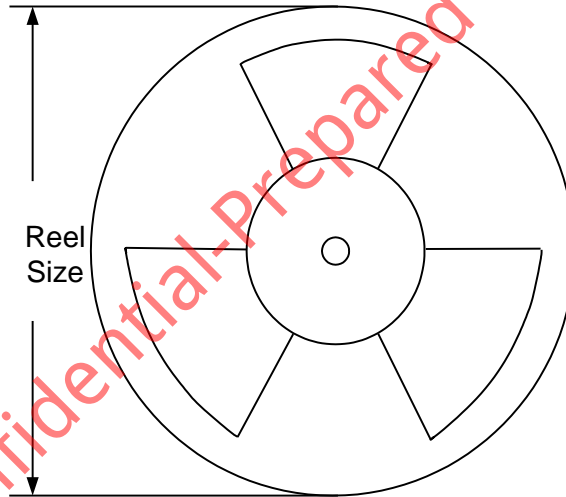

Package types	Tape width (mm)	Pocket pitch(mm)	Reel size (Inch)	Trailer length(mm)	Leader length (mm)	Qty per reel
SOT23-6	8	4	7"	280	160	3000
DFN2x2	8	4	7"	400	160	3000

**3. Others: NA**



## IMPORTANT NOTICE

- 1. Right to make changes.** Silergy and its subsidiaries (hereafter Silergy) reserve the right to change any information published in this document, including but not limited to circuitry, specification and/or product design, manufacturing or descriptions, at any time and without notice. This document supersedes and replaces all information supplied prior to the publication hereof. Buyers should obtain the latest relevant information before placing orders and should verify that such information is current and complete. All semiconductor products are sold subject to Silergy's standard terms and conditions of sale.
- 2. Applications.** Application examples that are described herein for any of these products are for illustrative purposes only. Silergy makes no representation or warranty that such applications will be suitable for the specified use without further testing or modification. Buyers are responsible for the design and operation of their applications and products using Silergy products. Silergy or its subsidiaries assume no liability for any application assistance or designs of customer products. It is customer's sole responsibility to determine whether the Silergy product is suitable and fit for the customer's applications and products planned. To minimize the risks associated with customer's products and applications, customer should provide adequate design and operating safeguards. Customer represents and agrees that it has all the necessary expertise to create and implement safeguards which anticipate dangerous consequences of failures, monitor failures and their consequences, lessen the likelihood of failures that might cause harm and take appropriate remedial actions. Silergy assumes no liability related to any default, damage, costs or problem in the customer's applications or products, or the application or use by customer's third-party buyers. Customer will fully indemnify Silergy, its subsidiaries, and their representatives against any damages arising out of the use of any Silergy components in safety-critical applications. It is also buyers' sole responsibility to warrant and guarantee that any intellectual property rights of a third party are not infringed upon when integrating Silergy products into any application. Silergy assumes no responsibility for any said applications or for any use of any circuitry other than circuitry entirely embodied in a Silergy product.
- 3. Limited warranty and liability.** Information furnished by Silergy in this document is believed to be accurate and reliable. However, Silergy makes no representation or warranty, expressed or implied, as to the accuracy or completeness of such information and shall have no liability for the consequences of use of such information. In no event shall Silergy be liable for any indirect, incidental, punitive, special or consequential damages, including but not limited to lost profits, lost savings, business interruption, costs related to the removal or replacement of any products or rework charges, whether or not such damages are based on tort or negligence, warranty, breach of contract or any other legal theory. Notwithstanding any damages that customer might incur for any reason whatsoever, Silergy' aggregate and cumulative liability towards customer for the products described herein shall be limited in accordance with the Standard Terms and Conditions of Sale of Silergy.
- 4. Suitability for use.** Customer acknowledges and agrees that it is solely responsible for compliance with all legal, regulatory and safety-related requirements concerning its products, and any use of Silergy components in its applications, notwithstanding any applications-related information or support that may be provided by Silergy. Silergy products are not designed, authorized or warranted to be suitable for use in life support, life-critical or safety-critical systems or equipment, nor in applications where failure or malfunction of an Silergy product can reasonably be expected to result in personal injury, death or severe property or environmental damage. Silergy assumes no liability for inclusion and/or use of Silergy products in such equipment or applications and therefore such inclusion and/or use is at the customer's own risk.
- 5. Terms and conditions of commercial sale.** Silergy products are sold subject to the standard terms and conditions of commercial sale, as published at <http://www.silergy.com/stdterms>, unless otherwise agreed in a valid written individual agreement specifically agreed to in writing by an authorized officer of Silergy. In case an individual agreement is concluded only the terms and conditions of the respective agreement shall apply. Silergy hereby expressly objects to and denies the application of any customer's general terms and conditions with regard to the purchase of Silergy products by the customer.
- 6. No offer to sell or license.** Nothing in this document may be interpreted or construed as an offer to sell products that is open for acceptance or the grant, conveyance or implication of any license under any copyrights, patents or other industrial or intellectual property rights. Silergy makes no representation or warranty that any license, either express or implied, is granted under any patent right, copyright, mask work right, or other intellectual property right. Information published by Silergy regarding third-party products or services does not constitute a license to use such products or services or a warranty or endorsement thereof. Use of such information may require a license from a third party under the patents or other intellectual property of the third party, or a license from Silergy under the patents or other intellectual property of Silergy.

For more information, please visit: [www.silergy.com](http://www.silergy.com)

© 2018 Silergy Corp.

All Rights Reserved.

## X-ON Electronics

Largest Supplier of Electrical and Electronic Components

*Click to view similar products for [Power Switch ICs - Power Distribution](#) category:*

*Click to view products by [Silergy](#) manufacturer:*

Other Similar products are found below :

[NCP45520IMNTWG-L](#) [TCK111G,LF\(S](#) [FPF1018](#) [DS1222](#) [TCK2065G,LF](#) [SZNCP3712ASNT3G](#) [TLE7244SL](#) [MIC2033-05BYMT-T5](#)  
[MIC2033-12AYMT-T5](#) [MIC2033-05BYM6-T5](#) [AP22811BW5-7](#) [SLG5NT1437VTR](#) [SZNCP3712ASNT1G](#) [DML1008LDS-7](#)  
[KTS1640QGDV-TR](#) [KTS1641QGDV-TR](#) [BTS500101TADATMA2](#) [NCV459MNWTBG](#) [NCP4545IMNTWG-L](#) [NCV8412ASTT1G](#)  
[NCV8412ASTT3G](#) [FPF2260ATMX](#) [SLG5NT1765V](#) [SLG5NT1757V](#) [SLG59M1557VTR](#) [BD2222G-GTR](#) [NCP45780IMN24RTWG](#)  
[NCP45540IMNTWG-L](#) [FDC6324L-TP](#) [FDC6326L-TP](#) [FDC6330L-TP](#) [U6210](#) [U25135](#) [U62153](#) [U6513BS](#) [U62133](#) [U6773H](#) [U62143S](#)  
[U6315BS](#) [U6513B](#) [U6110](#) [SL3405S](#) [BTS7040-2EPA](#) [SY6282ACC](#) [WS3222D-8/TR](#) [DP25136C](#) [DK5V100R20C](#) [SY6281AAC](#)  
[DK5V45R25P](#) [DK5V100R10M](#)