



# Application Note: SY6288E1/E2

## 3A Low Loss Power Distribution Switch

### General Description

SY6288E1/E2 is an ultra-low  $R_{DS(ON)}$ , 3A Low Loss Power Distribution switch with current limit to protect the power source from over current and short circuit conditions. It incorporates over temperature protection and reverse blocking function.

### Ordering Information

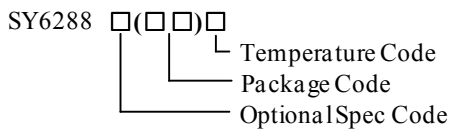

Ordering Number	Package type	UL certified	TUV certified
SY6288E1AAC	SOT23-5	YES	YES
SY6288E2AAC	SOT23-5	YES	YES

### Features

- Input voltage: 2.5V to 5.5V
- Extremely Low Power Path Resistance: 45mΩ (typ.)
- 3A load current capability
- Two Enable polarities:
  - SY6288E1AAC: Active High
  - SY6288E2AAC: Active Low
- Over temperature shutdown and automatic retry
- Reverse blocking (no body diode)
- Fault flag (OCB) output for over current and fault conditions
- At shutdown, OUT can be forced higher than IN
- Built-in soft-start
- Compact package minimizes the board space: SOT23-5
- RoHS Compliant and Halogen Free
- UL certification NO. 20160229-E333762
- TUV certification NO. R 50188769

### Applications

- USB 3.1 Application
- USB 3G Datacard
- USB Dongle
- MiniPCI Accessories
- USB Charger
- Public Place Multi-USB Charger

### Typical Application Circuit

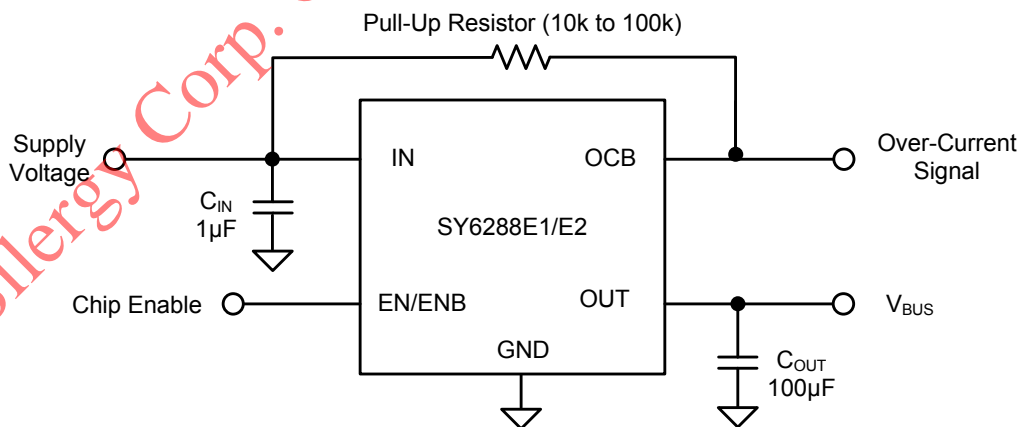

Note: If 1uF input cap will lead to large  $V_{in}$  voltage spike, it is strongly recommended to add additional 10uF ceramic cap.

Figure 1. Schematic Diagram (SY6288E1/E2)

## Pinout (Top View)

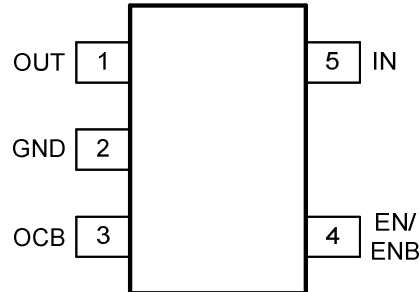

Part Number	Package type	Top Mark <sup>⓪</sup>
SY6288E1AAC	SOT23-5	<b>Kmxyz</b>
SY6288E2AAC	SOT23-5	<b>Nexyz</b>

Note ①: x=year code, y=week code, z=lot number code.

Pin Name	Pin number	Pin Description
	SOT23-5	
OUT	1	Output pin, decoupled with a 10μF capacitor to GND.
GND	2	Ground pin
OCB	3	Open Drain Fault Flag
EN/ENB	4	ON/OFF control. Do not leave it floating. EN: Active high; ENB: Active low.
IN	5	Input pin, decoupled with a 10μF capacitor to GND

## Block Diagram

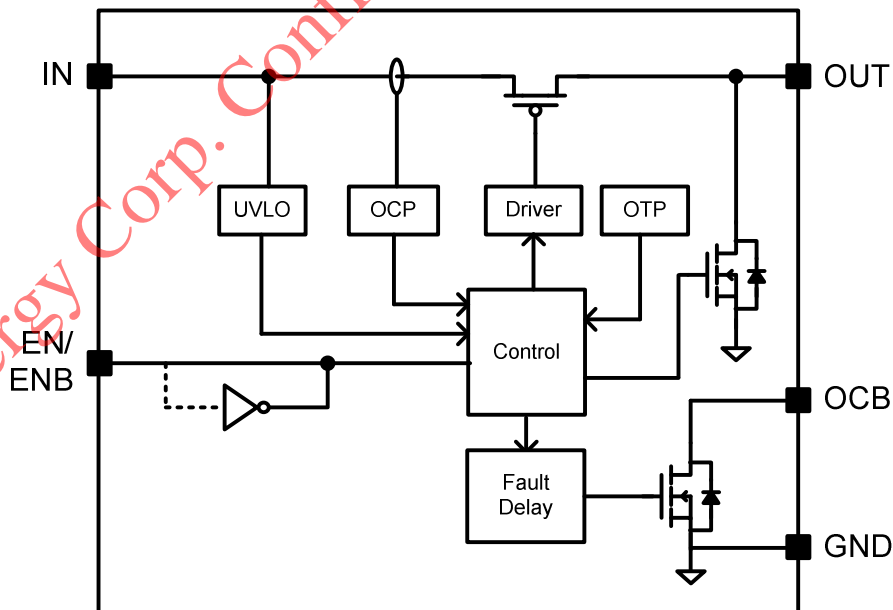



# SY6288E1/E2

## Absolute Maximum Ratings (Note 1)

All pins	6V
Power Dissipation, Pd @ TA = 25°C SOT23-5	1.7W
Package Thermal Resistance (Note 2)	
$\theta_{JA}$	61°C/W
$\theta_{JC}$	22°C/W
Junction Temperature	150°C
Lead Temperature (Soldering, 10 sec.)	260°C
Storage Temperature Range	-65°C to 150°C

## Recommended Operating Conditions (Note 3)

IN	2.5V to 5.5V
All other pins	0V to 5.5V
Junction Temperature Range	-40°C to 125°C
Ambient Temperature Range	-40°C to 85°C

Silergy Corp. Confidential-Prepared for alger



## Electrical Characteristics

( $V_{IN} = 5V$ ,  $C_{OUT} = 10\mu F$ ,  $T_A = 25^\circ C$  unless otherwise specified)

Parameter	Symbol	Test Conditions	Min	Typ	Max	Unit
Input Voltage Range	$V_{IN}$		2.5		5.5	V
Shutdown Input Current	$I_{SHDN}$	Open load, switch off		0.1	1	$\mu A$
		Output grounded, switch off		0.1	1	$\mu A$
Quiescent Supply Current	$I_Q$	Open load, switch on		35		$\mu A$
FET $R_{DS(ON)}$	$R_{DS(ON)}$	SOT23-5, $V_{IN} = 5V$ $I_{OUT} = 0.5A$		45		$m\Omega$
Current Limit	$I_{LIM}$	$V_{IN} = 5V$ , $V_{OUT} = 4V$	3.2	3.76	4.43	A
Fold back Current	$I_{FBC}$	$V_{IN} = 5V$ , $V_{OUT} = 1V$		2.1	2.8	A
EN/ENB Threshold	Logic-Low Voltage	$V_{IL}$			0.5	V
	Logic-High Voltage	$V_{IH}$	1.0			V
IN UVLO Threshold	$V_{IN,UVLO}$				2.45	V
IN UVLO Hysteresis	$V_{IN,HYS}$			0.1		V
Rise Time	$T_{RISE}$	$V_{IN} = 3.3V$ , $R_L = 3\Omega$ , $C_L = 1\mu F$	1	1.5	2	ms
		$V_{IN} = 5.0V$ , $R_L = 5\Omega$ , $C_L = 1\mu F$	1.6	2.3	3	ms
OCB Low Resistance	$R_{OCB}$			100		$\Omega$
OCB Delay Time	$T_{OCB\_Delay}$			10		ms
OUT Shutdown Discharge Resistance	$R_{DIS}$		50	63	76	$\Omega$
Thermal Shutdown Temperature	$T_{SD}$			150		$^\circ C$
Thermal Shutdown Hysteresis	$T_{HYS}$			20		$^\circ C$

**Note 1:** Stresses beyond “Absolute Maximum Ratings” may cause permanent damage to the device. These are for stress ratings. Functional operation of the device at these or any other conditions beyond those indicated in the operational sections of the specifications is not implied. Exposure to absolute maximum rating conditions for extended periods may affect device reliability.

**Note 2:**  $\theta_{JA}$  is measured in the natural convection at  $T_A = 25^\circ C$  on a low effective single layer thermal conductivity test board of JEDEC 51-3 thermal measurement standard. Pin 2 of SOT23 packages is the case position for  $\theta_{JC}$  measurement.

**Note 3:** The device is not guaranteed to function outside its operating conditions.

**Typical Performance Characteristics**

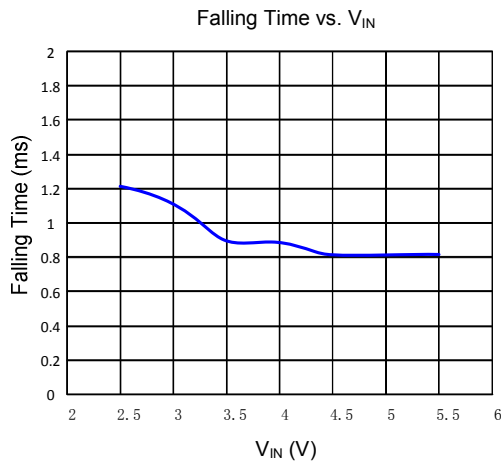
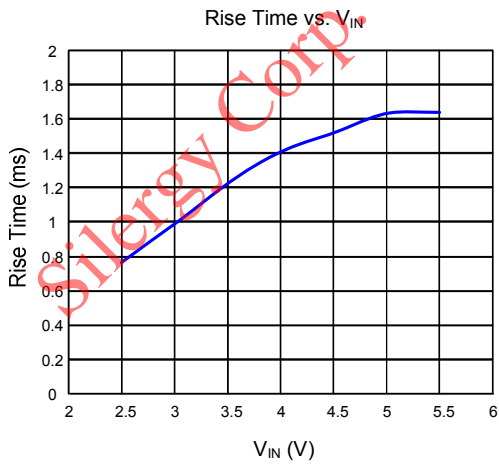
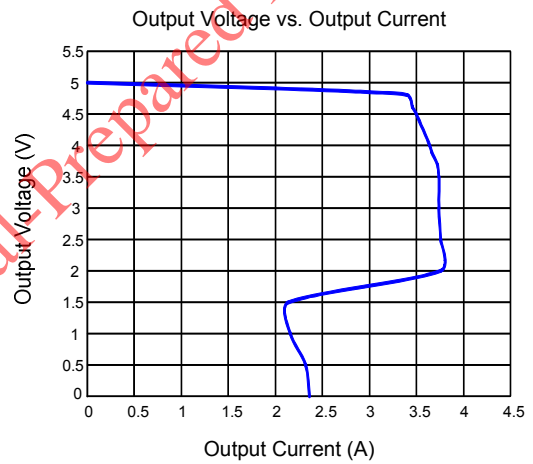
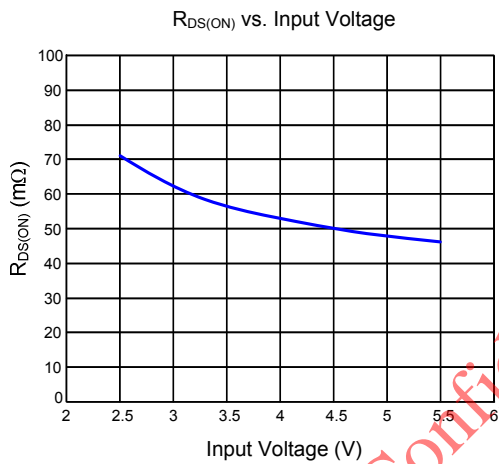
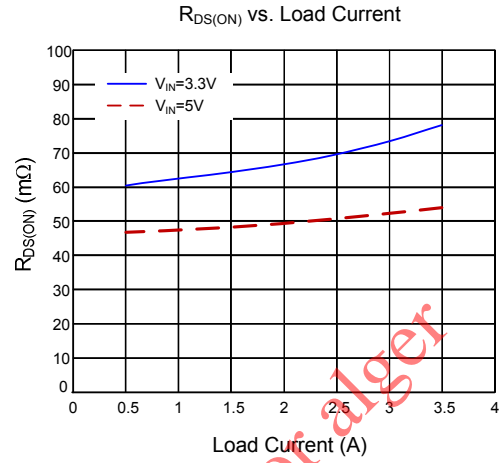
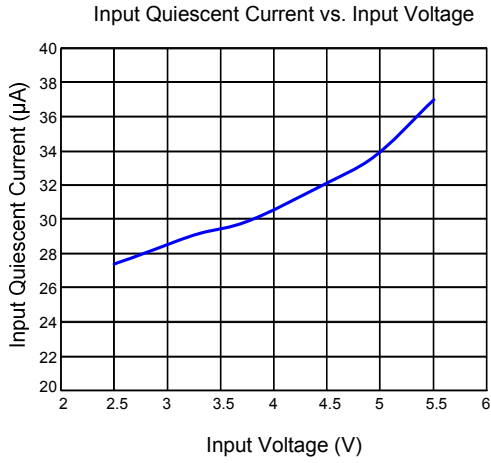

Startup from Enable  
( $V_{IN}=5V$ ,  $I_o=2.5A$ )

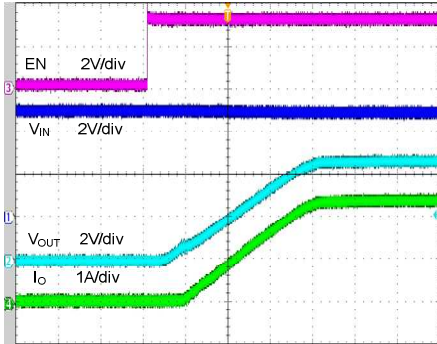

Time (800 $\mu$ s/div)

Shutdown from Enable  
( $V_{IN}=5V$ ,  $I_o=2.5A$ )

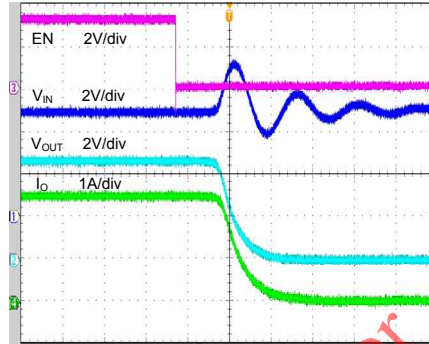

Time (4 $\mu$ s/div)

Startup from  $V_{IN}$   
( $V_{IN}=5V$ ,  $I_o=0.5A$ )

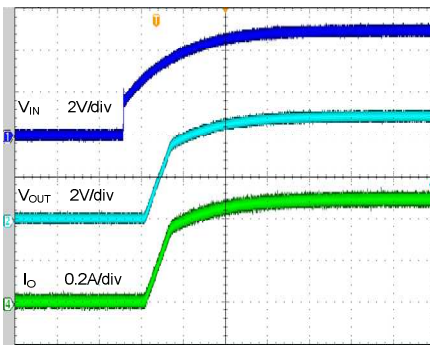

Time(2ms/div)

Shutdown from  $V_{IN}$   
( $V_{IN}=5V$ ,  $I_o=0.5A$ )

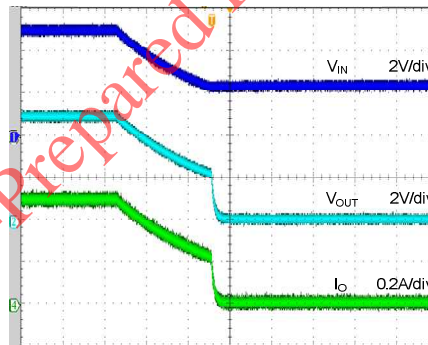

Time (800 $\mu$ s/div)

OCB Response  
(OCB Response during Over Load)

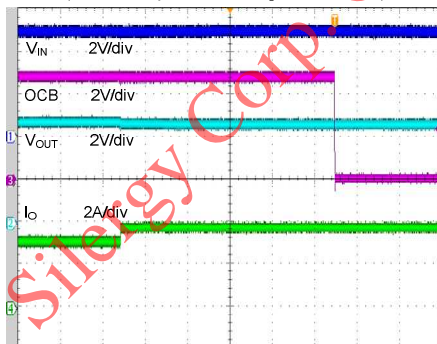

Time (2ms/div)

OCB Response  
(OCB Response during Short Circuit)

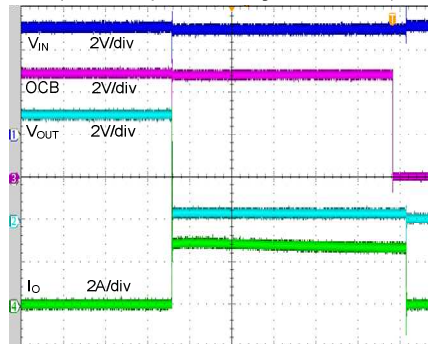

Time (2ms/div)



## Applications Information

### Output Discharge

SY6288E1/E2 integrates a 60Ω pull down resistor for quick output discharge. The resistor is activated when the switch is turned off.

### Over-current protection

SY6288E1/E2 has a 3.76A fixed current limit value. When the over-current condition is sensed, SY6288E1/E2 is modulated to achieve constant output current. Under output short circuit conditions, the normal current limit folded back 50%.

### Thermal Shutdown Protection

If the junction temperature of the device exceeds the thermal protection threshold which is typically 150 °C, over temperature protection will shut down SY6288E1/E2. Once the chip temperature drops to 130°C, the SY6288E1/E2 will restart.

### Fault flag

The OCB pin is an active-low, open drain output. It is high impedance when there's no protection occurring or the device is disable. When the device is enable, the OCB pin goes low whenever over-current protection or thermal shutdown protection occurs.

### Input Capacitor

To reduce device inrush current, a 10μF ceramic capacitor, C<sub>IN</sub>, is recommended. A higher value of C<sub>IN</sub> can be used to reduce the voltage drop

experienced as the switch is turned on into large capacitive load.

To minimize the potential noise problem, place C<sub>IN</sub> really close to the IN and GND pins.

### Output Capacitor

A 10μF ceramic output cap is recommended to prevent parasitic board inductance from forcing V<sub>OUT</sub> below GND when switching off.

### PCB Layout Guide

For best performance of the SY6288E1/E2, the following guidelines must be strictly followed:

- Keep all power traces as short and wide as possible and use at least 2 ounce copper for all power traces.
- Place a ground plane under all circuitry to lower both resistance and inductance and improve DC and transient performance.
- Input decoupling ceramic capacitor should be placed as close as possible between IN and GND pin to reduce the leakage inductance.
- Output decoupling ceramic capacitor should be placed as close as possible between OUT and GND pin to reduce the leakage inductance.

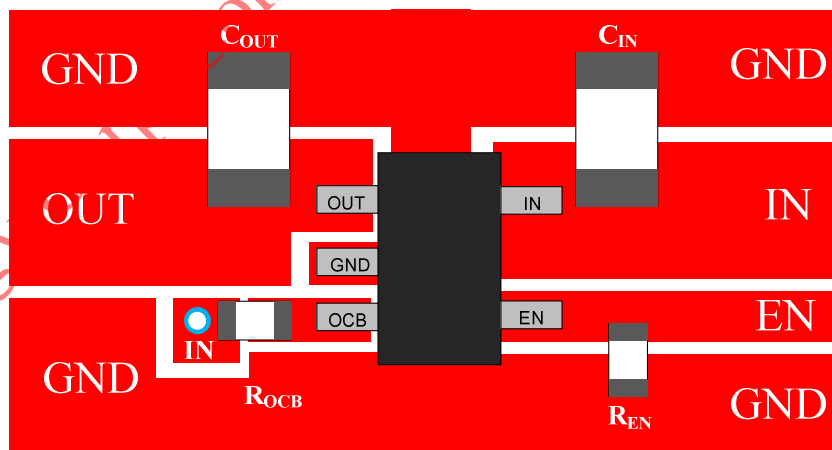

SOT23-5 Package outline & PCB layout design

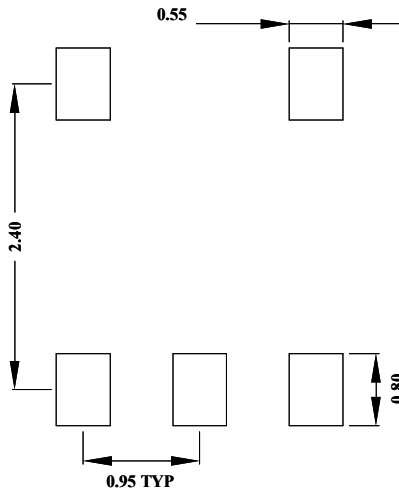

Recommended Pad Layout

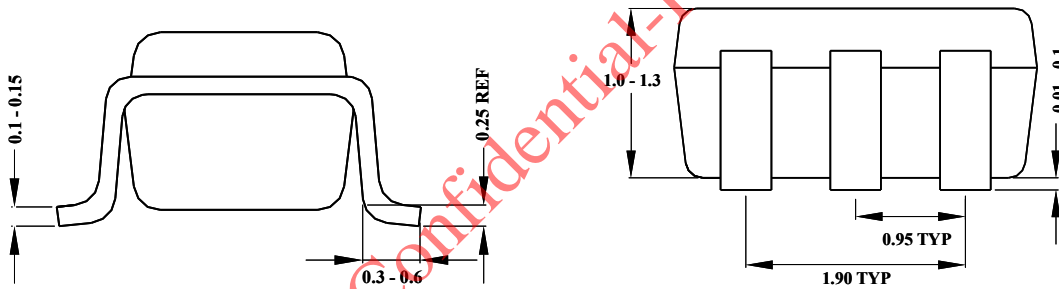
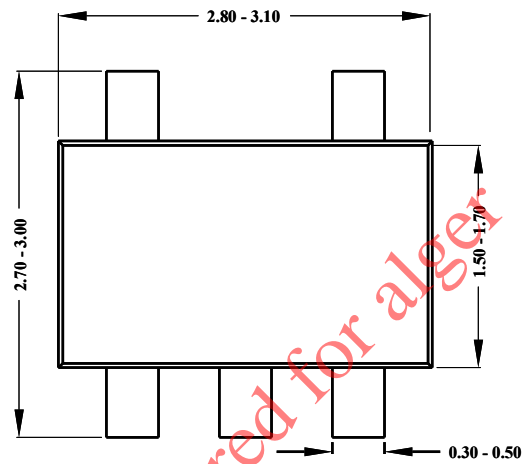

Notes: All dimensions are in millimeters.  
All dimensions don't include mold flash & metal burr.



**Taping & Reel Specification**

**1. SOT23-5 taping orientation**

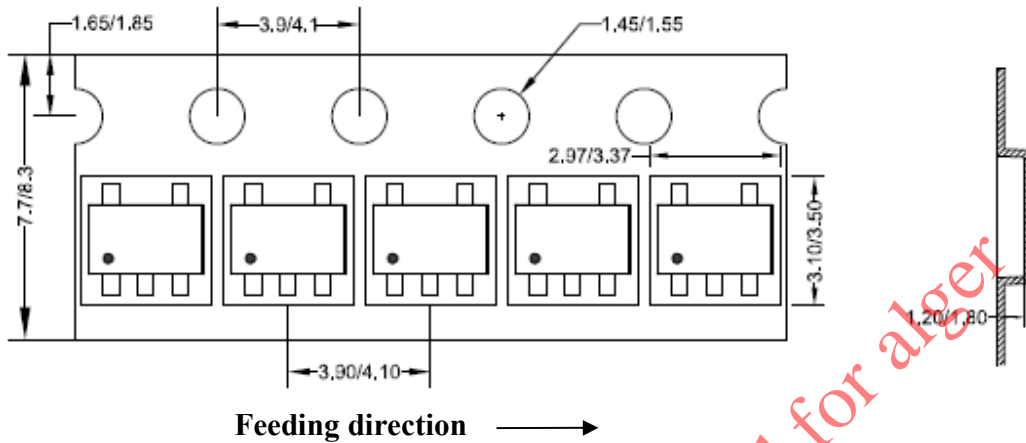

**2. Carrier Tape & Reel specification for packages**

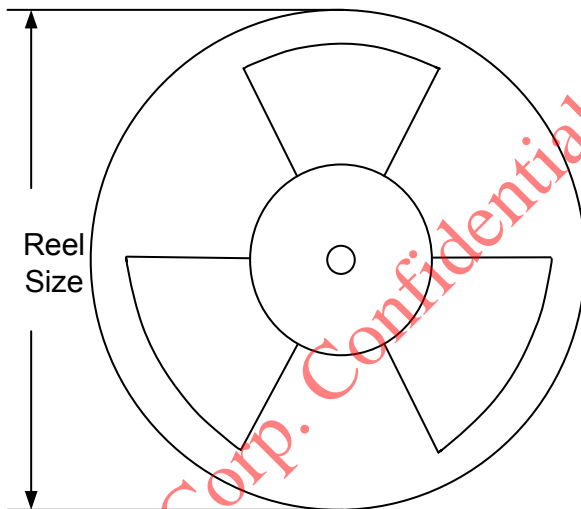

Package type	Tape width (mm)	Pocket pitch(mm)	Reel size (Inch)	Trailer length(mm)	Leader length (mm)	Qty per reel
SOT23-5	8	4	7"	280	160	3000

**3. Others: NA**

## X-ON Electronics

Largest Supplier of Electrical and Electronic Components

*Click to view similar products for [Switching Controllers](#) category:*

*Click to view products by [Silergy](#) manufacturer:*

Other Similar products are found below :

[LV5725JAZ-AH](#) [AP3844CMTR-E1](#) [NCP1218AD65R2G](#) [NCP1234AD100R2G](#) [NCP1244BD065R2G](#) [NCP1336ADR2G](#) [NCP1587GDR2G](#)  
[NCP6153MNTWG](#) [NCP81101BMNTXG](#) [NCP81205MNTXG](#) [CAT874-80ULGT3](#) [SJE6600](#) [AZ7500BMTR-E1](#) [IR35215MTRPBF](#)  
[SG3845DM](#) [NCP4204MNTXG](#) [NCP6132AMNR2G](#) [NCP81102MNTXG](#) [NCP81203MNTXG](#) [NCP81206MNTXG](#) [NX2155HCUPTR](#)  
[UBA2051C](#) [IR35201MTRPBF](#) [AP3842CMTR-E1](#) [NCP1015ST65T3G](#) [NCP1240AD065R2G](#) [NCP1240FD065R2G](#) [NCP1361BABAYSNT1G](#)  
[NCP1230P100G](#) [NCP1612BDR2G](#) [NX2124CSTR](#) [SG2845M](#) [NCP1366BABAYDR2G](#) [NCP81101MNTXG](#) [TEA19362T/1J](#)  
[NCP81174NMNTXG](#) [NCP4308DMTTWG](#) [NCP4308DMNTWG](#) [NCP4308AMTTWG](#) [NCP1366AABAYDR2G](#) [NCP1256ASN65T1G](#)  
[NCP1251FSN65T1G](#) [NCP1246BLD065R2G](#) [MB39A136PFT-G-BND-ERE1](#) [NCP1256BSN100T1G](#) [LV5768V-A-TLM-E](#)  
[NCP1365BABCYDR2G](#) [NCP1365AABCYDR2G](#) [IR35204MTRPBF](#) [MCP1633T-E/MG](#)