



Applications Note: AN_SY8032E

High Efficiency 1MHz, 2.5A Continuous, 3A Peak, Synchronous Step Down Regulator

General Description

The SY8032E is a high-efficiency, high frequency synchronous step-down DC-DC regulator IC capable of delivering up to 2.5A output current. The SY8032E operates over a wide input voltage range from 2.7V to 5.5V and integrate main switch and synchronous switch with very low $R_{DS(ON)}$ to minimize the conduction loss.

Low output voltage ripple and small external inductor and capacitor sizes are achieved with greater than 1MHz switching frequency.

Features

- Low $R_{DS(ON)}$ for internal switches (top/bottom):100mΩ/80mΩ,2.5A
- 2.7-5.5V input voltage range
- 2.5A continuous, 3A peak load current capability
- High switching frequency minimizes the external components: 1MHz
- CCM only operation
- Internal softstart limits the inrush current
- 100% dropout operation
- RoHS Compliant and Halogen Free
- Compact package: SOT23-6. Other packages are available upon requests

Ordering Information

SY8032 □(□□)□

Temperature Code
Package Code
Optional Spec Code

Ordering Number	Package type	Note ^U
SY8032EABC	SOT23-6	----

Applications

- LCD TV
- Set Top Box
- Net PC
- Mini-Notebook PC
- Access Point Router

Typical Applications

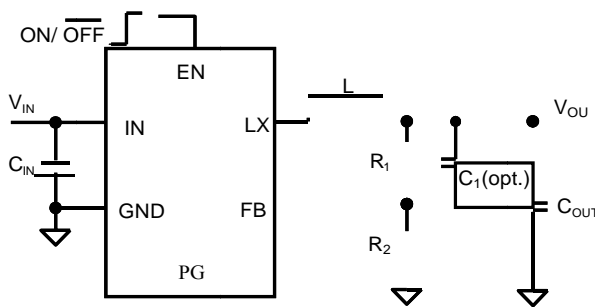

Figure 1. Schematic diagram

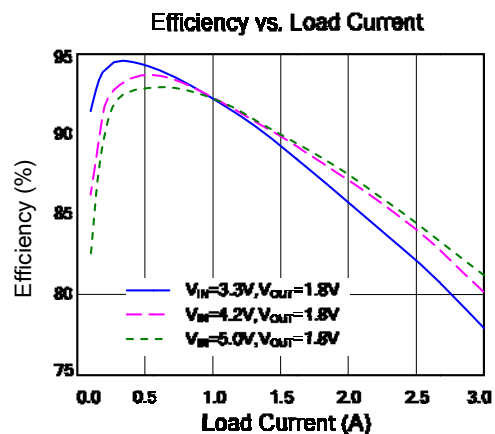
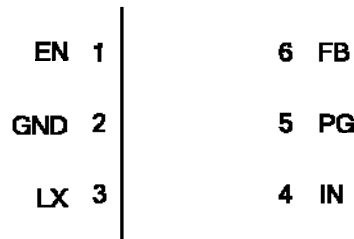

Figure 2. Efficiency vs Load Current



Pinout (top view)



SOT23-6

Top Mark: MBxyz (device code: MB, x=year code, y=week code, z= lot number code)

Pin Name	Pin Number	Pin Description
EN	1	Enable control. Pull high to turn on. Do not float.
GND	2	Ground pin
LX	3	Inductor pin. Connect this pin to the switching node of inductor.
IN	4	Input pin. Decouple this pin to GND pin with at least 10uF ceramic cap.
PG	5	Power good indicator (Open drain output). Low if the output < 90% of regulation voltage; High otherwise. Connect a pull-up resistor to the input.
FB	6	Output Feedback Pin. Connect this pin to the center point of the output resistor divider (as shown in Figure 1) to program the output voltage: $V_{out}=0.6*(1+R_1/R_2)$.

Absolute Maximum Ratings (Note 1)

Supply Input Voltage ----- 6.0V
 Enable, FB Voltage ----- $V_{IN} + 0.6V$
 LX Voltage ----- $-0.3V^{(*)}$ to $6V^{(**)}$
 Power Dissipation, P_D @ $T_A = 25^\circ C$,
 SOT23-6----- 0.6W
 Package Thermal Resistance (Note 2)
 θ_{JA} ----- $140^\circ C/W$
 θ_{JC} ----- $70^\circ C/W$
 Junction Temperature Range ----- $150^\circ C$
 Lead Temperature (Soldering, 10 sec.) ----- $260^\circ C$
 Storage Temperature Range ----- $65^\circ C$ to $150^\circ C$
^(*) LX Voltage tested down to $-3V < 10ns$
^(**) LX Voltage tested up to $+7V < 50ns$

Recommended Operating Conditions (Note 3)

Supply Input Voltage ----- 2.7V to 5.5V
 Junction Temperature Range ----- $40^\circ C$ to $125^\circ C$
 Ambient Temperature Range ----- $40^\circ C$ to $85^\circ C$



Electrical Characteristics

($V_{IN} = 5V$, $V_{OUT} = 2.5V$, $L = 2.2\mu H$, $C_{OUT} = 10\mu F$, $T_A = 25^\circ C$, unless otherwise specified)

Parameter	Symbol	Test Conditions	Min	Typ	Max	Unit
Input Voltage Range	V_{IN}		2.7		5.5	V
Shutdown Current	I_{SHDN}	EN=0		0.1	1	μA
Feedback Reference Voltage	V_{REF}		0.588	0.6	0.612	V
FB Input Current	I_{FB}	$V_{FB}=V_{IN}$	-50		50	nA
PFET RON	$R_{DS(ON)P}$			100		m Ω
NFET RON	$R_{DS(ON)N}$			80		m Ω
PFET Current Limit	I_{LIM}		3.5			A
EN rising threshold	V_{ENH}		1.5			V
EN falling threshold	V_{ENL}				0.4	V
Input UVLO threshold	V_{UVLO}				2.7	V
UVLO hysteresis	V_{HYS}			0.1		V
Oscillator Frequency	F_{OSC}	$I_{OUT}=500mA$		1		MHz
Min ON Time				90		ns
Max Duty Cycle			100			%
Thermal Shutdown Temperature	T_{SD}			160		$^\circ C$

Note 1: Stresses beyond “Absolute Maximum Ratings” may cause permanent damage to the device. These are for stress ratings. Functional operation of the device at these or any other conditions beyond those indicated in the operational sections of the specifications is not implied. Exposure to absolute maximum rating conditions for extended periods may affect device reliability.

Note 2: θ_{JA} is measured in the natural convection at $T_A = 25^\circ C$ on a low effective single layer thermal conductivity test board of JEDEC 51-3 thermal measurement standard. Pin 2 of SOT23-6 packages is the case position for θ_{JC} measurement.

Note 3: The device is not guaranteed to function outside its operating conditions.



SILERGY

Function Block

AN_SY8032E

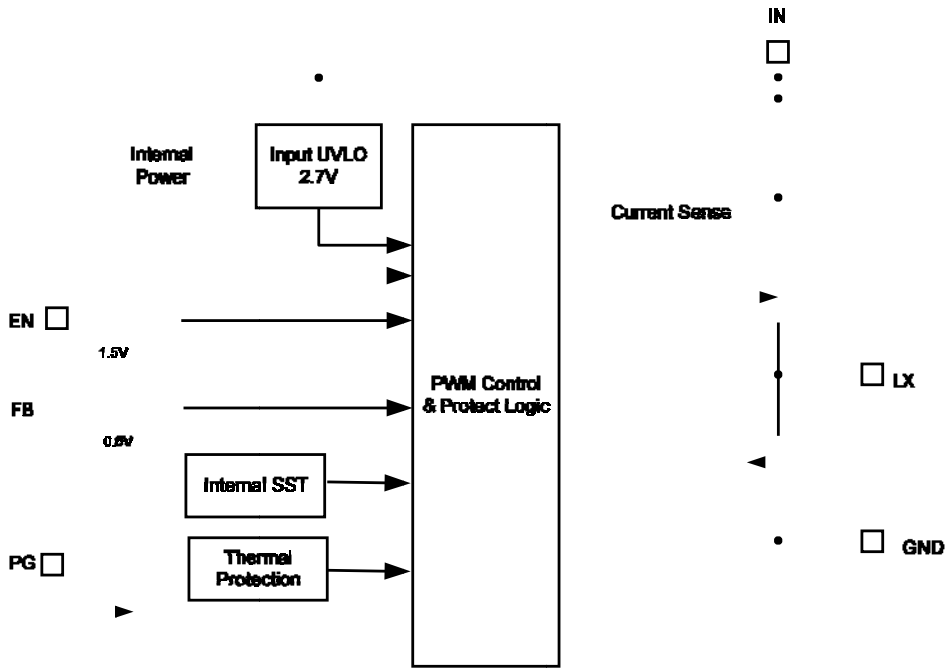



Typical Performance Characteristics

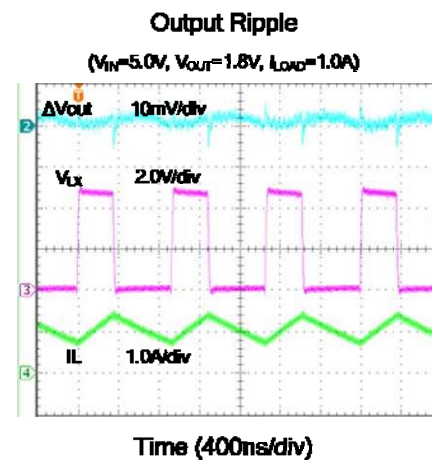
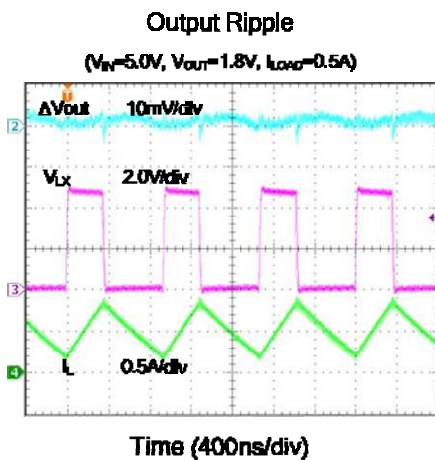
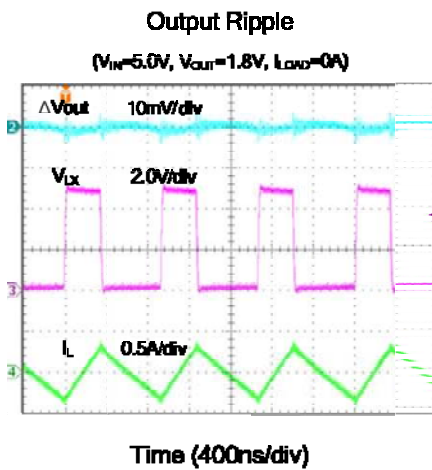
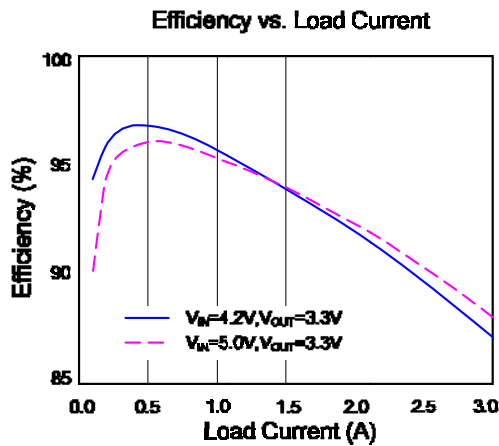
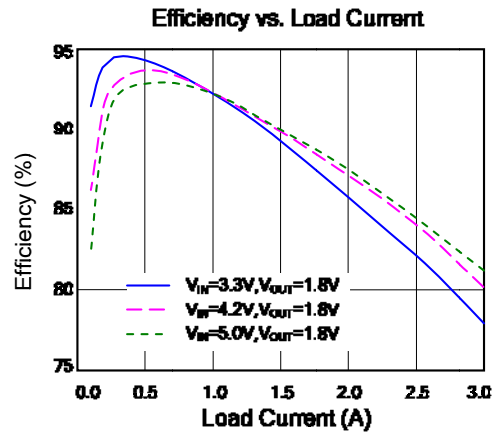
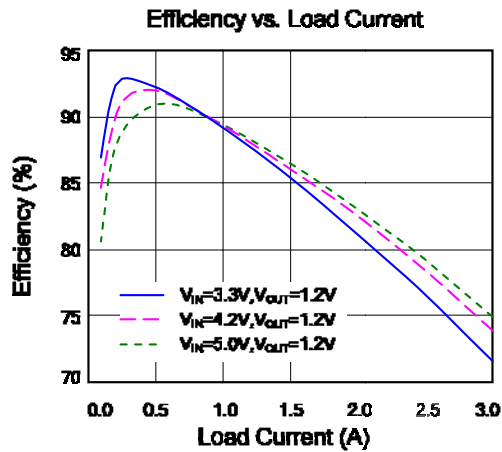



Output Ripple

($V_{IN}=5.0V$, $V_{OUT}=1.8V$, $I_{LOAD}=2.5A$)

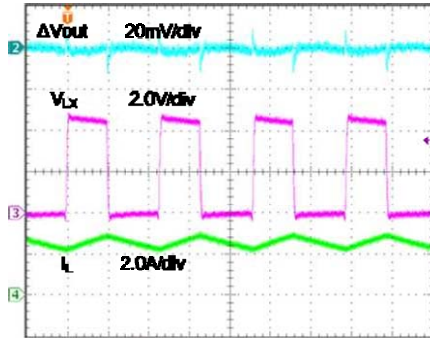

Time (400ns/div)

Startup from VIN

($V_{IN}=5.0V$, $V_{OUT}=1.8V$, $I_{LOAD}=2.5A$)

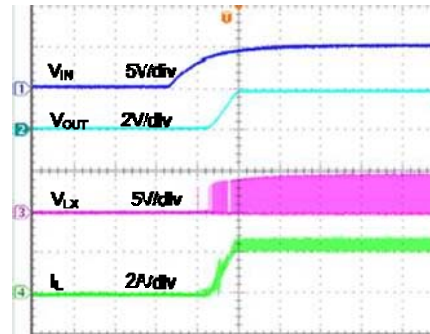

Time (1ms/div)

Shutdown from VIN

($V_{IN}=5.0V$, $V_{OUT}=1.8V$, $I_{LOAD}=2.5A$)

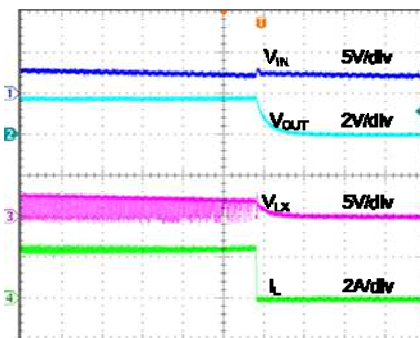

Time (100us/div)

Startup from Enable

($V_{IN}=5.0V$, $V_{OUT}=1.8V$, $I_{LOAD}=2.5A$)

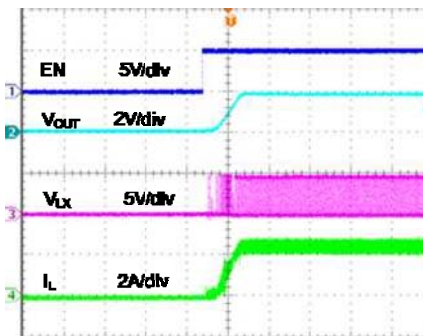

Time (1ms/div)

Shutdown from Enable

($V_{IN}=5.0V$, $V_{OUT}=1.8V$, $I_{LOAD}=2.5A$)

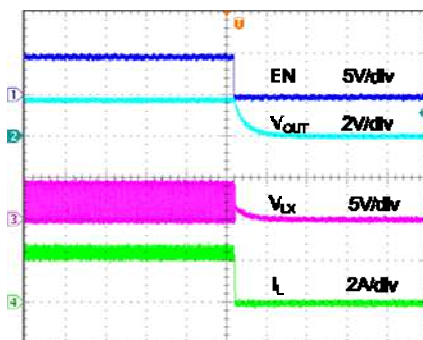

Time (100us/div)



AN_SY8032E

Hard Short Protection
($V_{in}=5.0V, V_{out}=1.8V$, Null Load To Short)

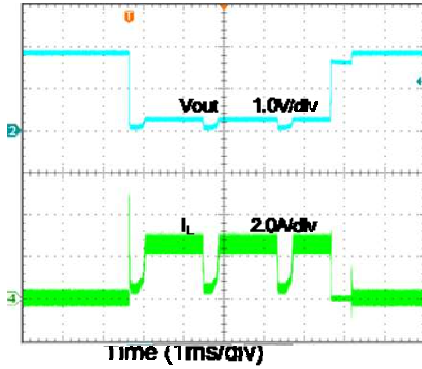

Hard Short Protection
($V_{in}=5.0V, V_{out}=1.8V, 2.5A$ to Short)

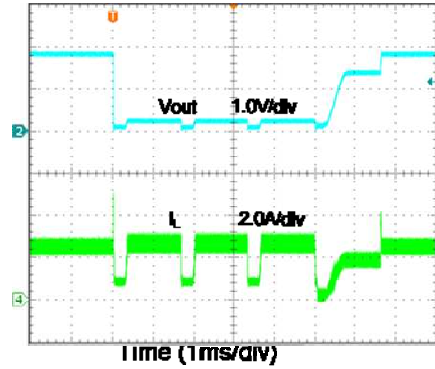

Load Transient
($V_{in}=5.0V, V_{out}=1.8V, I_{Load}=0.25-2.5A$)

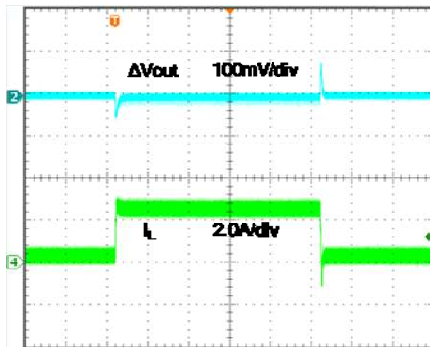

Time (100μs/div)

Load Transient
($V_{in}=5.0V, V_{out}=1.8V, I_{Load}=0-1.25A$)

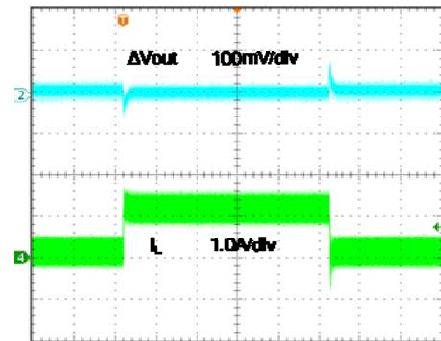

Time (100μs/div)



SILERGY

AN_SY8032E

Operation

SY8032E is a synchronous buck regulator IC that integrates the PWM control, top and bottom switches on the same die to minimize the switching transition loss and conduction loss. With ultra low $R_{DS(ON)}$ power switches and proprietary PWM control, this regulator IC can achieve the highest efficiency and the highest switch frequency simultaneously to minimize the external inductor and capacitor size, and thus achieving the minimum solution footprint.

Applications Information

Because of the high integration in the SY8032E IC, the application circuit based on this regulator IC is rather simple. Only input capacitor C_{IN} , output capacitor C_{OUT} , output inductor L and feedback resistors (R1 and R2) need to be selected for the targeted applications specifications.

Feedback resistor dividers R1 and R2:

Choose R1 and R2 to program the proper output voltage. To minimize the power consumption under light loads, it is desirable to choose large resistance values for both R1 and R2. A value of between 10k and 200k is highly recommended for R2. If R2=100k is chosen, then R1 can be calculated to be:

$$R_1 = \frac{(V_{OUT} - 0.6V) \cdot R_2}{0.6V}$$

Input capacitor C_{IN} :

With the maximum load current at 1.2A, the maximum ripple current through input capacitor is about 0.6Arms. A typical X7R or better grade ceramic capacitor with 6V rating and greater than 4.7uF capacitance can handle this ripple current well. To minimize the potential noise problem, place this ceramic capacitor really close to the IN and GND pins. Care should be taken to minimize the loop area formed by C_{IN} , and IN/GND pins.

Output capacitor C_{OUT} :

The output capacitor is selected to handle the output ripple noise requirements. Both steady state ripple and transient requirements must be taken into consideration when selecting this capacitor. For the best performance, it is recommended to use X7R or better grade ceramic capacitor with 6V rating and greater than 40uF capacitance.

Output inductor L:

There are several considerations in choosing this inductor.

- 1) Choose the inductance to provide the desired ripple current. It is suggested to choose the ripple current to be about 40% of the maximum output current. The inductance is calculated as:

$$L = \frac{V_{OUT}(1 - V_{OUT}/V_{IN,MAX})}{F_{SW} \times I_{OUT,MAX} \times 40\%}$$

where Fsw is the switching frequency and $I_{OUT,MAX}$ is the maximum load current.

The SY8032E regulator IC is quite tolerant of different ripple current amplitude. Consequently, the final choice of inductance can be slightly off the calculation value without significantly impacting the performance.

- 2) The saturation current rating of the inductor must be selected to be greater than the peak inductor current under full load conditions.

$$I_{SAT,MIN} > I_{OUT,MAX} + \frac{V_{OUT}(1 - V_{OUT}/V_{IN,MAX})}{2 \cdot F_{SW} \cdot L}$$

- 3) The DCR of the inductor and the core loss at the switching frequency must be low enough to achieve the desired efficiency requirement. It is desirable to choose an inductor with $DCR < 50m\Omega$ to achieve a good overall efficiency.

Layout Design:

The layout design of SY8032E regulator is relatively simple. For the best efficiency and minimum noise problems, we should place the following components close to the IC: C_{IN} , L, R1 and R2.

- 1) It is desirable to maximize the PCB copper area connecting to GND pin to achieve the best thermal and noise performance. If the board space allowed, a ground plane is highly desirable.
- 2) C_{IN} must be close to Pins IN and GND. The loop area formed by C_{IN} and GND must be minimized.
- 3) The PCB copper area associated with LX pin must be minimized to avoid the potential noise problem.
- 4) The components R1 and R2, and the trace connecting to the FB pin must NOT be adjacent to the LX net on the PCB layout to avoid the noise problem.
- 5) If the system chip interfacing with the EN pin has a high impedance state at shutdown mode and the IN pin is connected directly to a power source such as a LiIon battery, it is desirable to add a pull down $1M\Omega$ resistor between the EN and GND pins to prevent the noise from falsely turning on the regulator at shutdown mode.

Load Transient Considerations:

The SY8032E regulator IC integrates the compensation components to achieve good stability and fast transient responses. In some applications, adding a 22pF ceramic cap in parallel with R1 may further speed up the load transient responses and is thus recommended for applications with large load transient step requirements.

SOT23-6 Package outline & PCB layout design

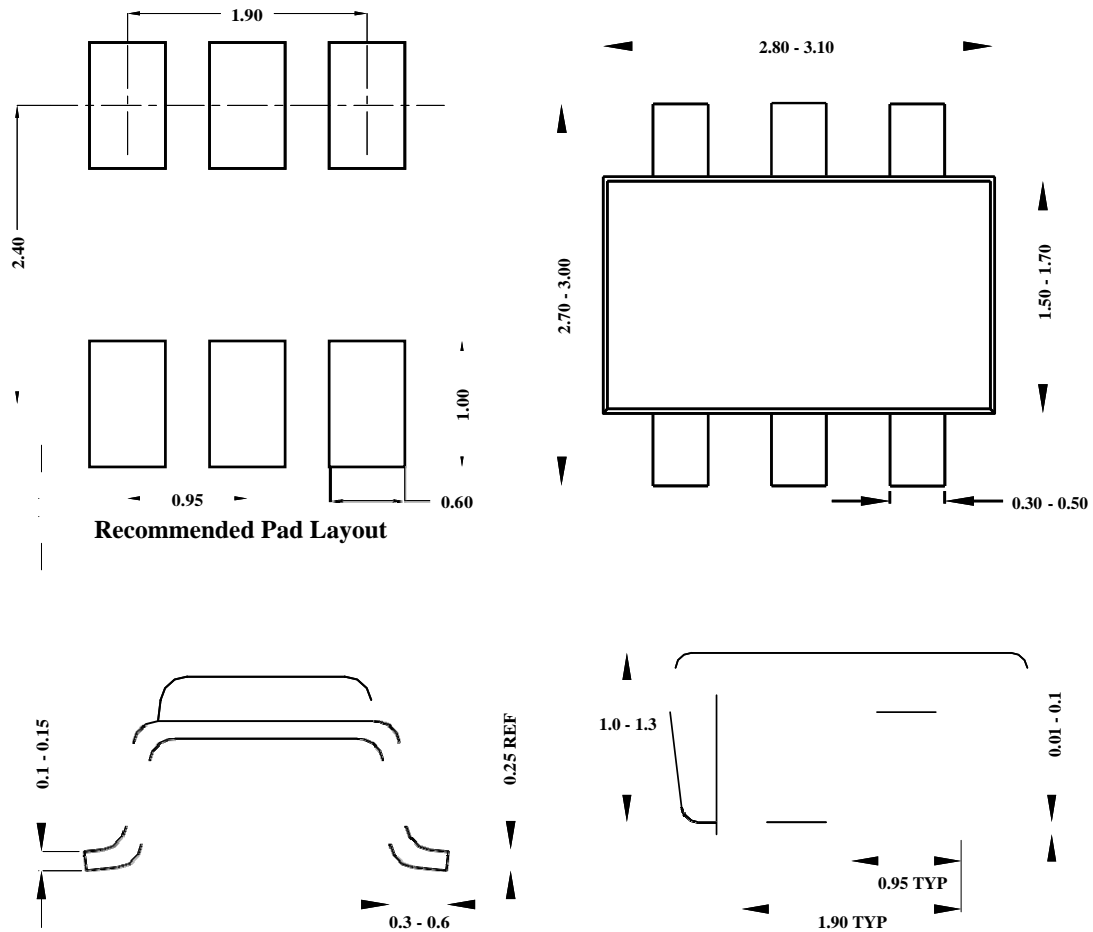

Recommended Pad Layout

**Notes: All dimensions are in millimeters.
All dimensions don't include mold flash & metal burr.**

SOT23-6 Package outline & PCB layout design

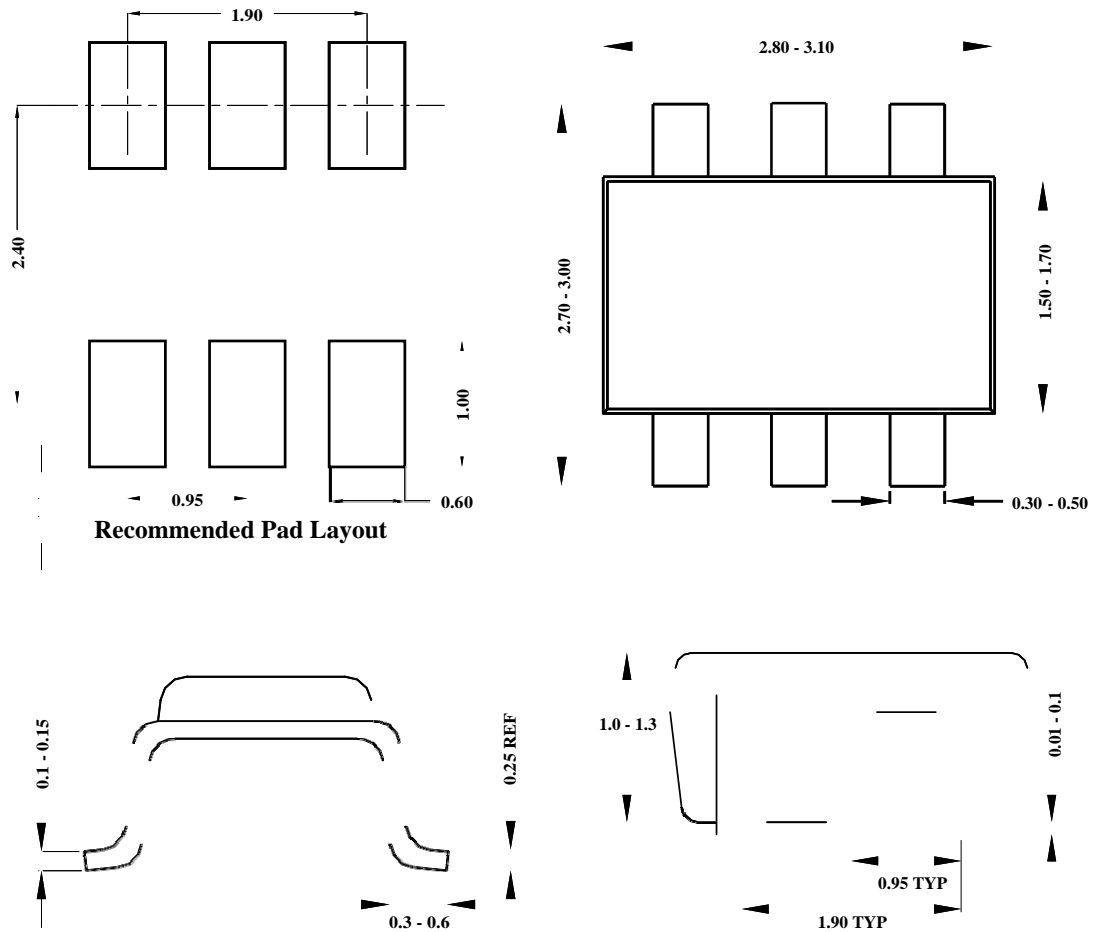

**Notes: All dimensions are in millimeters.
All dimensions don't include mold flash & metal burr.**

Taping & Reel Specification

1. Taping orientation

SOT23-6

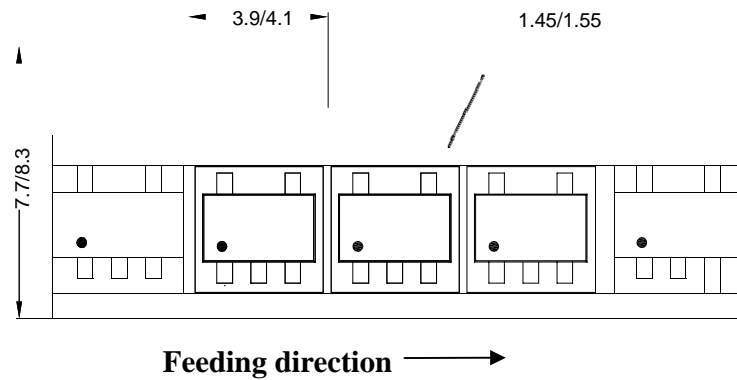

2. Carrier Tape & Reel specification for packages

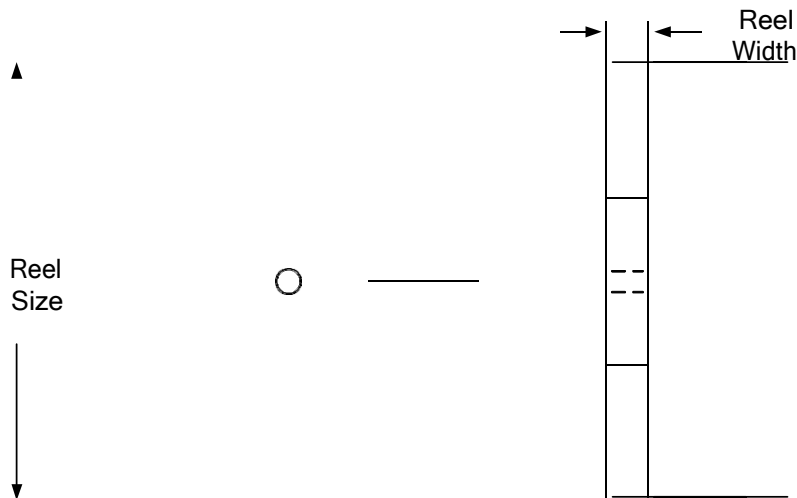

Package types	Tape width (mm)	Pocket pitch(mm)	Reel size (Inch)	Reel width(mm)	Trailer length(mm)	Leader length (mm)	Qty per reel
SOT23-6	8	4	7"	8.4	280	160	3000

3. Others: NA

X-ON Electronics

Largest Supplier of Electrical and Electronic Components

Click to view similar products for [Isolated DC/DC Converters](#) category:

Click to view products by [Silergy](#) manufacturer:

Other Similar products are found below :

[FMD15.24G](#) [PSL486-7LR](#) [Q48T30020-NBB0](#) [18362](#) [JAHW100Y1](#) [SPB05C-12](#) [SQ24S15033-PS0S](#) [19-130041](#) [CE-1003](#) [CE-1004](#)
[RDS180245](#) [MAU228](#) [J80-0041NL](#) [DFC15U48D15](#) [XGS-1205](#) [NCT1000N040R050B](#) [SPB05B-15](#) [SPB05C-15](#) [L-DA20](#) [DCG40-5G](#)
[QME48T40033-PGB0](#) [AK1601-9RT](#) [DPA423R](#) [VI-R5022-EXWW](#) [PSC128-7iR](#) [RPS8-350ATX-XE](#) [DAS1004812](#) [PQA30-D24-S24-DH](#) [vi-](#)
[m13-cw-03](#) [VI-LN2-EW](#) [VI-PJW01-CZY](#) [CK2540-9ERT](#) [AK-1615-7R](#) [700DNC40-CON-KIT-8G](#) [350DNC40-CON-KIT-9G](#) [088-101348-G](#)
[VI-L52-EW](#) [VI-L53-CV](#) [PQA30-D48-S12-TH](#) [VI-L50-IY](#) [VI-LC63-EV](#) [AM2D-051212DZ](#) [24IBX15-50-0ZG](#) [HZZ01204-G](#) [SPU02L-09](#)
[SPU02M-09](#) [SPU02N-09](#) [UNO-PS/350-900DC/24DC/60W](#) [QUINT4-BUFFER/24DC/20](#) [QUINT4-CAP/24DC/5/4KJ](#)