



Application Notes: AN_SYH407

High Efficiency 1.5MHz, 1A Synchronous Step Down Regulator

General Description

SYH407 is a high efficiency 1.5MHz synchronous step down DC/DC regulator IC capable of delivering up to 1A output current. It can operate over a wide input voltage range from 2.5V to 6.5V and integrate main switch and synchronous switch with very low $R_{DS(ON)}$ to minimize the conduction loss.

Ordering Information

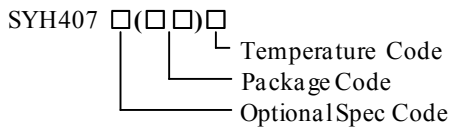

Temperature Range: -40°C to 85°C

| Ordering Number | Package Type | Note |
|-----------------|--------------|------|
| SYH407AAC | SOT23-5 | 1A |

Features

- Low $R_{DS(ON)}$ for internal switches (top/bottom) 260mΩ/170mΩ
- 2.5~6.5V input voltage range
- 40μA typical quiescent current
- High light load efficiency
- High switching frequency 1.5MHz minimizes the external components
- Internal soft-start limits the inrush current
- 100% dropout operation
- RoHS Compliant and Halogen Free
- Compact package: SOT23-5

Applications

- Portable Navigation Device
- Set Top Box
- USB Dongle
- Media Player
- Smart phone

Typical Application

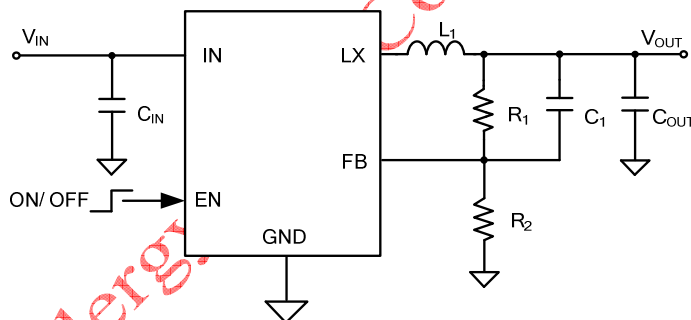

Figure1. Schematic Diagram

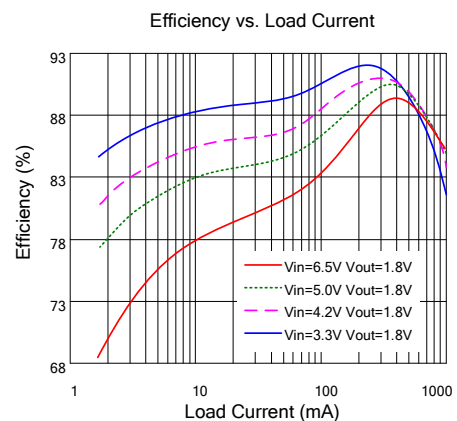
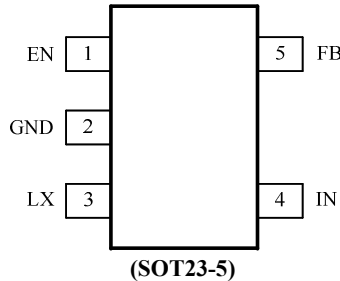

Figure2. Efficiency



Pinout (Top View)



Top Mark: TRxyz (device code: TR, x=year code, y=week code, z=lot number code)

| Pin Name | Pin Number | Pin Description |
|----------|------------|--|
| EN | 1 | Enable control. Pull high to turn on. Do not float. |
| GND | 2 | Ground pin. |
| LX | 3 | Inductor pin. Connect this pin to the switching node of the inductor. |
| IN | 4 | Input pin. Decouple this pin to the GND pin with at least 10uF ceramic capacitor. |
| FB | 5 | Output Feedback Pin. Connect this pin to the center point of the output resistor divider (as shown in Figure 1) to program the output voltage: $V_{OUT}=0.6*(1+R_1/R_2)$. Add optional C_1 (10pF~47pF) to speed up the transient response. |

Absolute Maximum Ratings (Note 1)

| | |
|---|-----------------|
| Supply Input Voltage | 7.0V |
| Enable, FB Voltage | $V_{IN} + 0.6V$ |
| Power Dissipation, P_D @ $T_A = 25^\circ C$, SOT23-5 | 0.6W |
| Package Thermal Resistance (Note 2) | |
| θ_{JA} | 170°C/W |
| θ_{JC} | 130°C/W |
| Junction Temperature Range | -125°C |
| Lead Temperature (Soldering, 10 sec.) | 260°C |
| Storage Temperature Range | -65°C to 150°C |

Recommended Operating Conditions (Note 3)

| | |
|----------------------------|----------------|
| Supply Input Voltage | 2.5V to 6.5V |
| Junction Temperature Range | -40°C to 125°C |
| Ambient Temperature Range | -40°C to 85°C |



Electrical Characteristics

($V_{IN} = 5V$, $V_{OUT} = 2.5V$, $L = 2.2\mu H$, $C_{OUT} = 10\mu F$, $T_A = 25^\circ C$, unless otherwise specified)

| Parameter | Symbol | Test Conditions | Min | Typ | Max | Unit |
|------------------------------|---------------|---|-------|-----|-------|------------|
| Input Voltage Range | V_{IN} | | 2.5 | | 6.5 | V |
| Quiescent Current | I_Q | $I_{OUT}=0, V_{FB}=V_{REF} \cdot 105\%$ | | 40 | | μA |
| Shutdown Current | I_{SHDN} | EN=0 | | 0.1 | 1 | μA |
| Feedback Reference Voltage | V_{REF} | | 0.588 | 0.6 | 0.612 | V |
| PFET RON | $R_{DS(ON)P}$ | | | 260 | | m Ω |
| NFET RON | $R_{DS(ON)N}$ | | | 170 | | m Ω |
| PFET Current Limit | I_{LIM} | | 1.3 | | | A |
| EN rising threshold | V_{ENH} | | 1.5 | | | V |
| EN falling threshold | V_{ENL} | | | | 0.4 | V |
| Input UVLO threshold | V_{UVLO} | | | | 2.5 | V |
| UVLO hysteresis | V_{HYS} | | | 0.1 | | V |
| Oscillator Frequency | F_{OSC} | | | 1.5 | | MHz |
| Min ON Time | | | | 80 | | ns |
| Max Duty Cycle | | | 100 | | | % |
| Soft Start Time | T_{SS} | | | 1 | | ms |
| Thermal Shutdown Temperature | T_{SD} | | | 150 | | $^\circ C$ |
| Thermal Shutdown Hysteresis | T_{HYS} | | | 15 | | $^\circ C$ |

Note 1: Stresses beyond the “Absolute Maximum Ratings” may cause permanent damage to the device. These are for stress ratings. Functional operation of the device at these or any other conditions beyond those indicated in the operational sections of the specifications is not implied. Exposure to absolute maximum rating conditions for extended periods may remain possibility to affect device reliability.

Note 2: θ_{JA} is measured in the natural convection at $T_A = 25^\circ C$ on a low effective single layer thermal conductivity test board of JEDEC 51-3 thermal measurement standard. Exposed Paddle of DFN package is the case position for θ_{JC} measurement.

Note 3: The device is not guaranteed to function outside its operating conditions.

Typical Performance Characteristics

Efficiency vs. Load Current

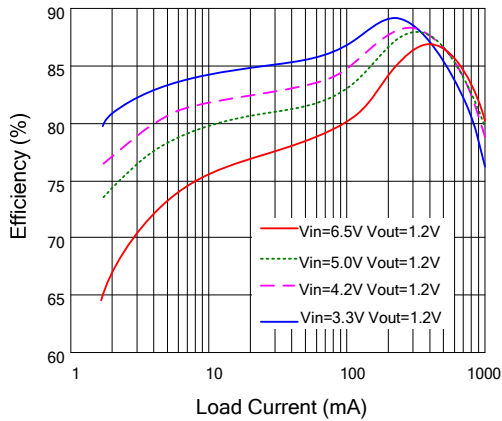

Efficiency vs. Load Current

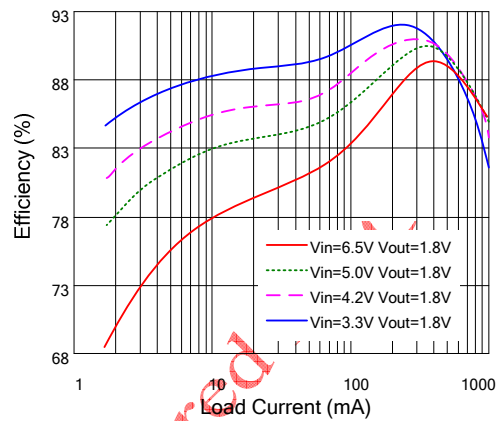

Efficiency vs. Load Current

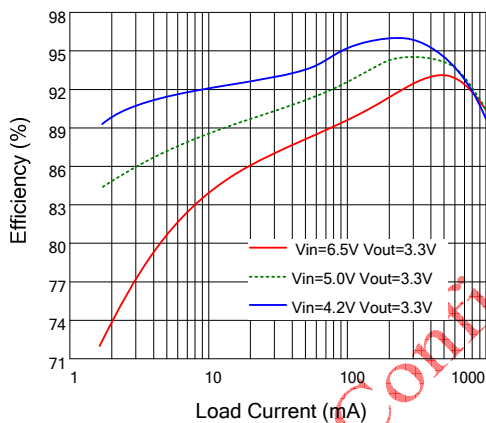

Output Ripple

($V_{in}=5.0V, V_{out}=1.8V, I_{load}=0A$)

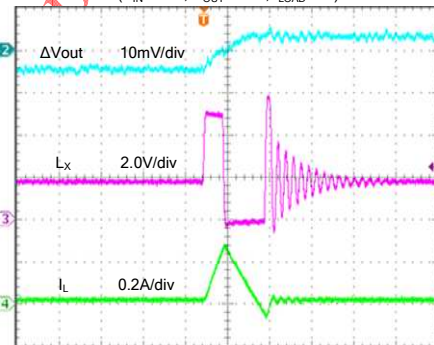

Time (400ns/div)

Output Ripple

($V_{in}=5.0V, V_{out}=1.8V, I_{load}=1.0A$)

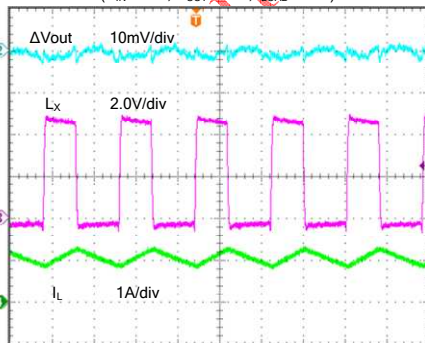

Time (400ns/div)

Short Circuit Protection

($V_{in}=5.0V, V_{out}=1.8V, I_{load}=1.0A$ -Short)

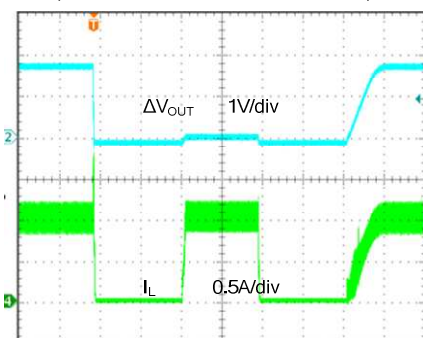

Time (1ms/div)

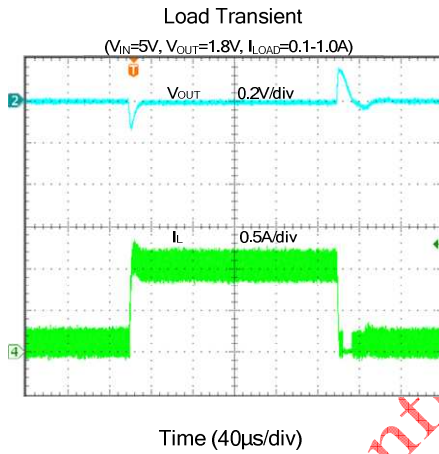
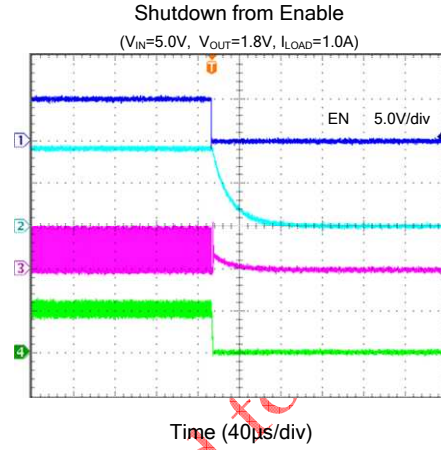
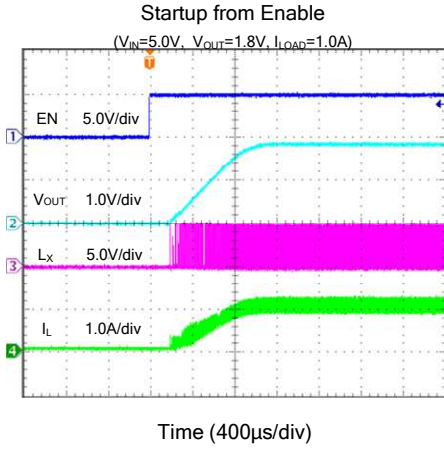

Silergy Corp. Confidential Prepared for Customer Use Only



Operation

The SYH407 is a high-efficiency 1.5MHz synchronous step-down DC-DC converters capable of delivering up to 1A output current. It operates over a wide input voltage range from 2.5V to 6.5V and integrates main switch and synchronous switch with very low $R_{DS(ON)}$ to minimize the conduction loss.

Applications Information

Because of the high integration in the SYH407 IC, the application circuit based on this regulator IC is rather simple. Only input capacitor C_{IN} , output capacitor C_{OUT} , output inductor L and feedback resistors (R1 and R2) need to be selected for the targeted applications specifications.

Feedback resistor dividers R1 and R2:

Choose R1 and R2 to program the proper output voltage. To minimize the power consumption under light loads, it is desirable to choose large resistance values for both R1 and R2. A value of between 100kΩ and 1MΩ is highly recommended for both resistors. If R2=120kΩ is chosen, then R1 can be calculated to be:

$$R_1 = \frac{(V_{OUT} - 0.6V) \cdot R_2}{0.6V}$$

Input capacitor C_{IN} :

A typical X7R or better grade ceramic capacitor with 10V rating and greater than 10uF capacitance is recommended. To minimize the potential noise problem, place this ceramic capacitor really close to the IN and GND pins. Care should be taken to minimize the loop area formed by C_{IN} , and IN/GND pins.

Output capacitor C_{OUT} :

The output capacitor is selected to handle the output ripple noise requirements. Both steady state ripple and transient requirements must be taken into consideration when selecting this capacitor. For the best performance, it is recommended to use X7R or better grade ceramic capacitor with 6V rating and greater than 4.7uF capacitance.

Output inductor L:

There are several considerations in choosing this inductor.

- 1) Choose the inductance to provide the desired ripple current. It is suggested to choose the ripple current to be about 40% of the maximum output current. The inductance is calculated as:

$$L = \frac{V_{OUT}(1 - V_{OUT}/V_{IN,MAX})}{F_{SW} \times I_{OUT,MAX} \times 40\%}$$

where F_{sw} is the switching frequency and $I_{out,max}$ is the maximum load current.

The SYH407 regulator IC is quite tolerant of different ripple current amplitude. Consequently, the final choice of inductance can be slightly off the calculation value without significantly impacting the performance.

- 2) The saturation current rating of the inductor must be selected to be greater than the peak inductor current under full load conditions.

$$I_{SAT,MIN} > I_{OUT,MAX} + \frac{V_{OUT}(1 - V_{OUT}/V_{IN,MAX})}{2 \cdot F_{SW} \cdot L}$$

- 3) The DCR of the inductor and the core loss at the switching frequency must be low enough to achieve the desired efficiency requirement. It is desirable to choose an inductor with DCR<50mohm to achieve a good overall efficiency.

Short Circuit Protection:

SYH407 integrates hic-cup mode hard short protection function. If output voltage is below 40% of the regulation voltage, the internal soft-start node and the error amplifier output will be reset immediately. IC works in hic-cup protection mode. The hiccup frequency is about 250Hz, and the hic-cup duty is 50%. If the hard short condition is removed, IC will go back to normal operation.

Load Transient Considerations:

The SYH407 regulator IC integrates the compensation components to achieve good stability and fast transient responses. In some applications, adding a 22pF ceramic cap in parallel with R1 may further speed up the load transient responses and is thus recommended for applications with large load transient step requirements.

Layout Design:



The layout design of SYH407 regulator is relatively simple. For the best efficiency and minimum noise problems, we should place the following components close to the IC: C_{IN} , L, R1 and R2.

- 1) It is desirable to maximize the PCB copper area connecting to GND pin to achieve the best thermal and noise performance. If the board space allowed, a ground plane is highly desirable.
- 2) C_{IN} must be close to Pins IN and GND. The loop area formed by C_{IN} and GND must be minimized.
- 3) The PCB copper area associated with LX pin must be minimized to avoid the potential noise problem.



4) The components R1 and R2, and the trace connecting to the FB pin must NOT be adjacent to the LX net on the PCB layout to avoid the noise problem.

PCB Layout Suggestion

-  Via
-  Top Layer
-  Bottom Layer

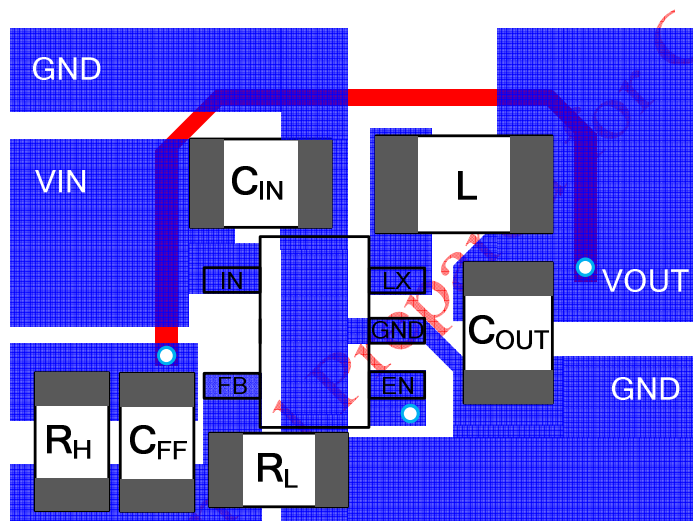

Silergy Corp. Confidential

SOT23-5 Package outline & PCB layout design

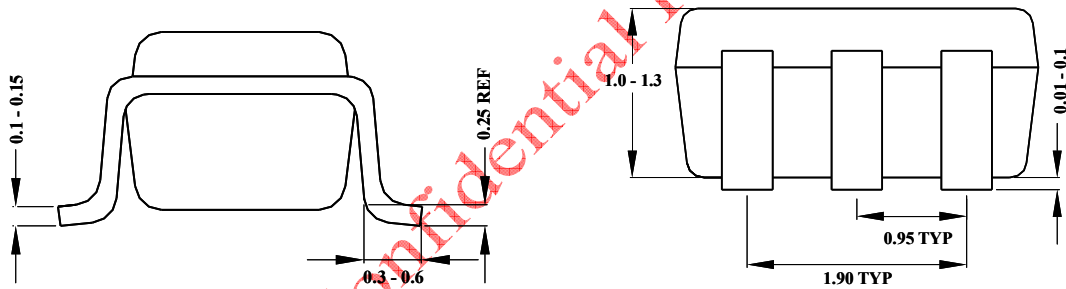
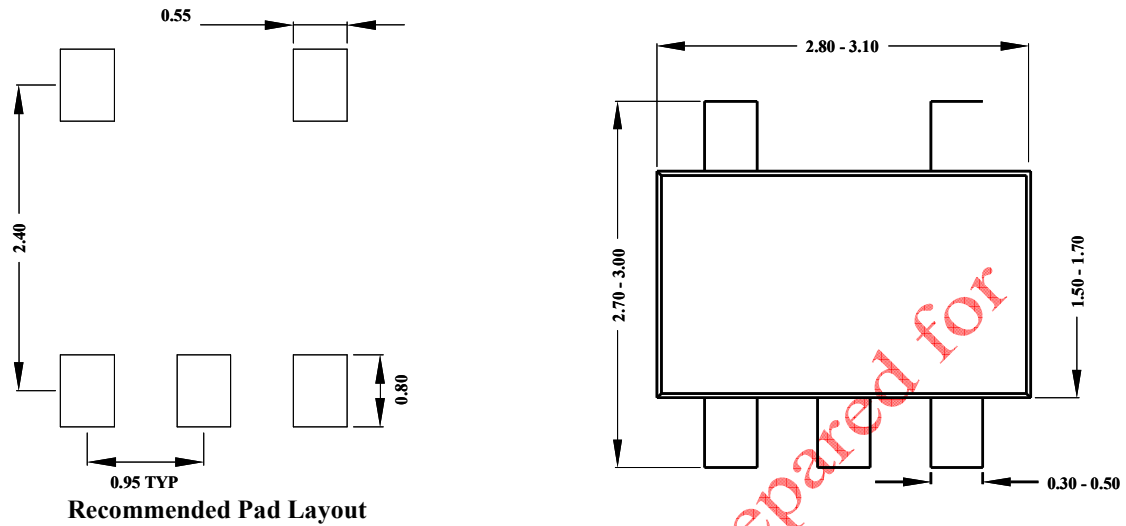

**Notes: All dimensions are in millimeters.
All dimensions don't include mold flash & metal burr.**

X-ON Electronics

Largest Supplier of Electrical and Electronic Components

Click to view similar products for [Isolated DC/DC Converters](#) category:

Click to view products by [Silergy](#) manufacturer:

Other Similar products are found below :

[ESM6D044440C05AAQ](#) [FMD15.24G](#) [PSL486-7LR](#) [PSR152.5-7IR](#) [Q48T30020-NBB0](#) [AVO240-48S12B-6L](#) [AVO250-48S28B-6L](#) [NAN-0505](#) [HW-L16D](#) [JAHW100Y1](#) [217-1617-001](#) [22827](#) [SPB05C-12](#) [SQ24S15033-PS0S](#) [18952](#) [19-130041](#) [CE-1003](#) [CE-1004](#) [GQ2541-7R](#) [PSE1000DCDC-12V](#) [RDS180245](#) [MAU228](#) [419-2065-201](#) [449-2075-101](#) [J80-0041NL](#) [V300C24C150BG](#) [419-2062-200](#) [419-2063-401](#) [419-2067-101](#) [419-2067-501](#) [419-2068-001](#) [DCG40-5G](#) [DFC15U48D15](#) [449-2067-000](#) [XGS-0512](#) [XGS-1205](#) [XGS-1212](#) [XGS-2412](#) [XGS-2415](#) [XKS-1215](#) [033456](#) [NCT1000N040R050B](#) [SPB05B-15](#) [SPB05C-15](#) [SSQE48T25025-NAA0G](#) [L-DA20](#) [HP3040-9RG](#) [HP1001-9RTG](#) [XKS-2415](#) [XKS-2412](#)