

UG163: Si1133/Si115x Optical Sensor Evaluation Board Rev 3.0 User's Guide

This board can be ordered as part number "115xOPT-EXP-EVB". The optical sensor expansion board is designed to allow customers to evaluate the Si1133 UV/ALS sensor and other Si115x series sensors. A list of these sensors and their capabilities follows:

- **UV/ALS**—Si1133 sensor mounted with a demonstration light diffuser assembly.
- **Long Range Proximity**—Si1153-AB09 2 x 2 mm proximity sensing chip with an on-die 940 nm bandpass filter for sunlight immunity. The board demonstrates the use of a 5 mm dia. lens and narrow-angle LED.
- **Sunlight Immune Proximity Module**—Si1153-AB9X, 2.85 x 4.9 mm proximity sensing module with an on-die 940 nm bandpass filter for sunlight immunity and an integrated 940 nm LED.
- **Proximity/ALS**—Si1153-AB00, 2 x 2 mm light sensor chip. The board uses a single 850 nm LED for demonstration purposes.
- **Gesture/ALS**—Si1153-AB00, 2 x 2 mm light sensor chip. The board uses three 850 nm LEDs spaced roughly 50 mm apart for demonstration purposes.

KEY FEATURES

- UV/ALS Sensor
- Long-Range Proximity Sensor
- Sunlight-Immune Proximity Module Sensor
- Gesture/ALS Sensor
- Compatible with Silicon Labs EFM EVBs and Optical Sensors Programmer Toolkit
- Simplicity Studio compatible

The optical sensor expansion board is designed to allow customers to connect to the sensors using two methods:

- Silicon Labs EFM series of EVBs with an expansion ports. e.g. the EFM32 Pearl Gecko PG12 Starter Kit: EFM32PG12 (SLSTK3402A)
- USB connectivity via the Optical Sensors Programmers Toolkit

The EVB comes with a plastic overlay that simulates a customers product and covers most of the sensors. The overlay is removed in the photo below.

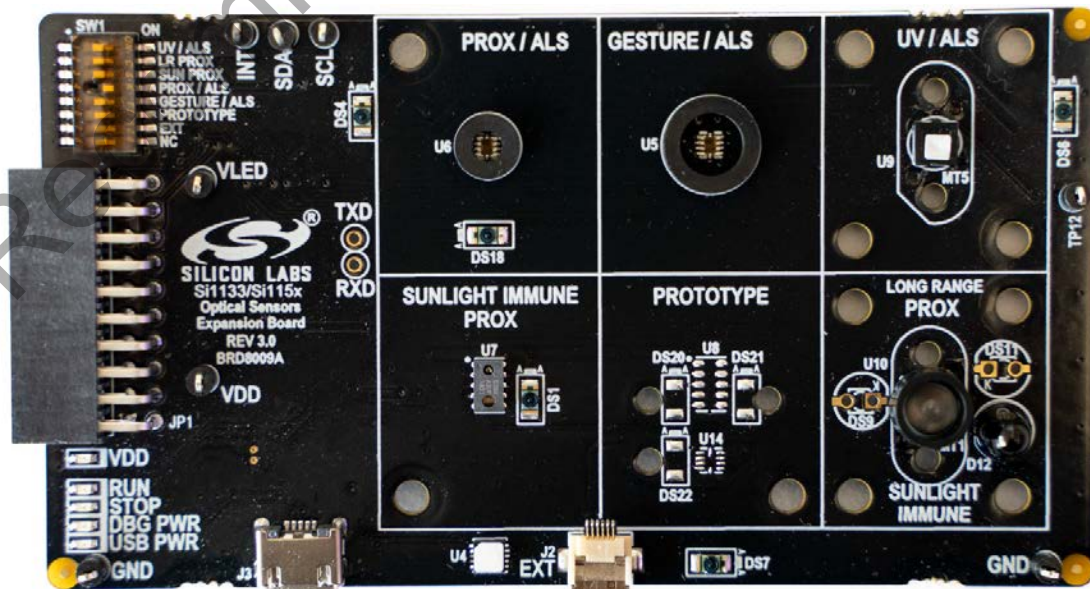

1. EVB Architecture

1.1 Board Block Diagram

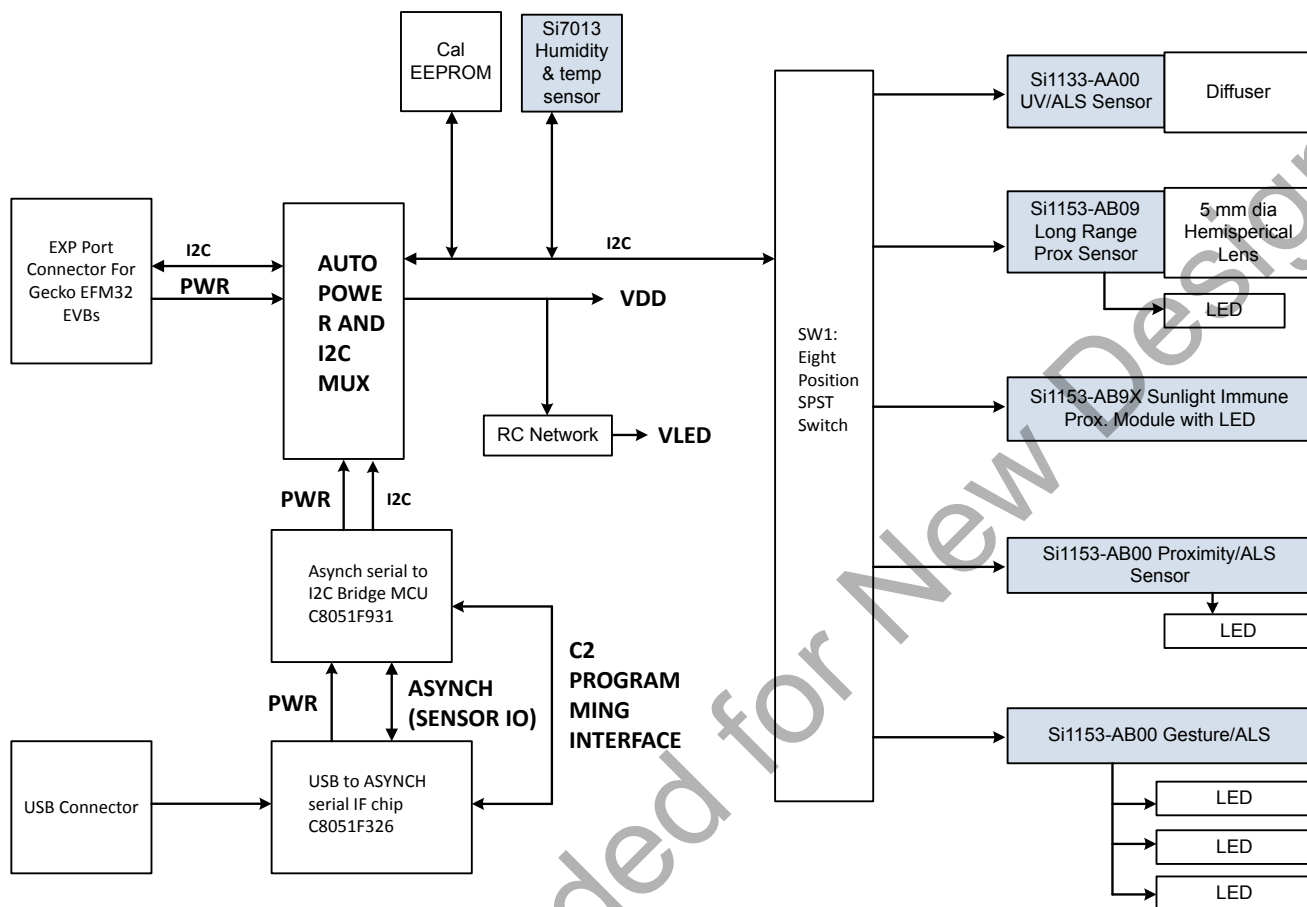

Figure 1.1. EVB Block Diagram (Silicon Labs Sensors Shown in Blue)

1.2 System Block Diagram with an EFM32 Host

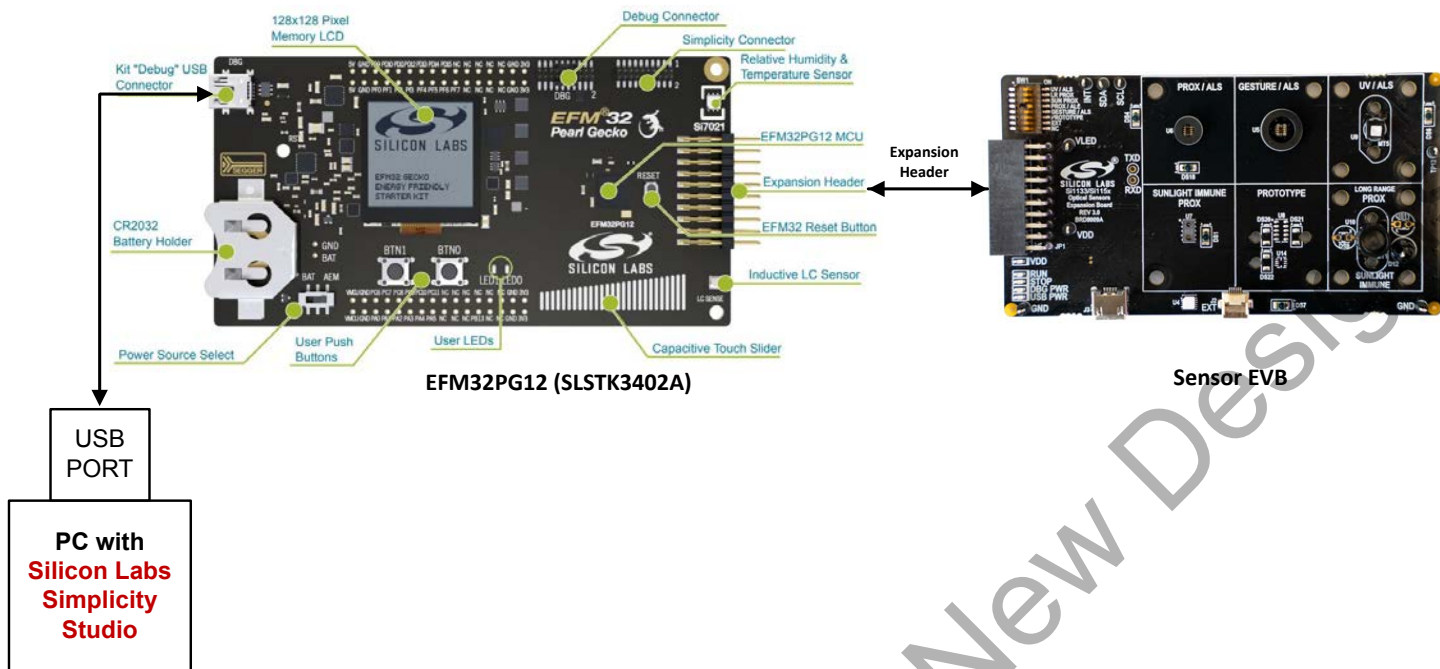

Figure 1.2. System Block Diagram with EFM Host

1.3 System Block Diagram with a PC Remote Host

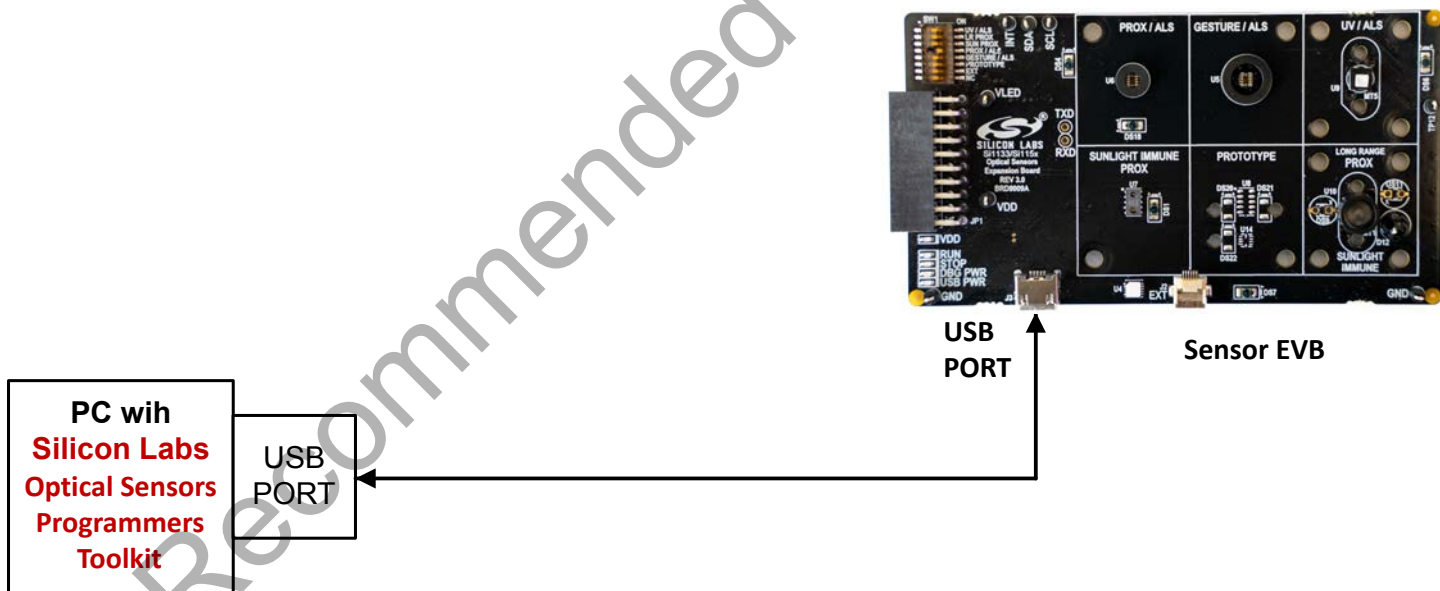

Figure 1.3. System Block Diagram with PC Remote Host

2. Board Setup and Use

2.1 SW1 Switch Configuration

It is important to note that only one of the sensors can be used at a time. That means only one of the eight switches in SW1 should be moved to the right (the ON position) at a time. Each of the first five switches selects a different sensor on the board. The sixth position selects a prototype area, the seventh selects an external expansion connector compatible with the Silicon Labs postage stamp boards while the last is not used.

It is important to note that whenever the user wants to switch between sensors the board must be reset and the software restarted. This is because only the SDA SCL line is switched by SW1 and a sensor that has set up could be generating interrupts when you want to switch to another sensor.

2.2 Board Setup for UV/ALS and the Optical Programmer's Toolkit

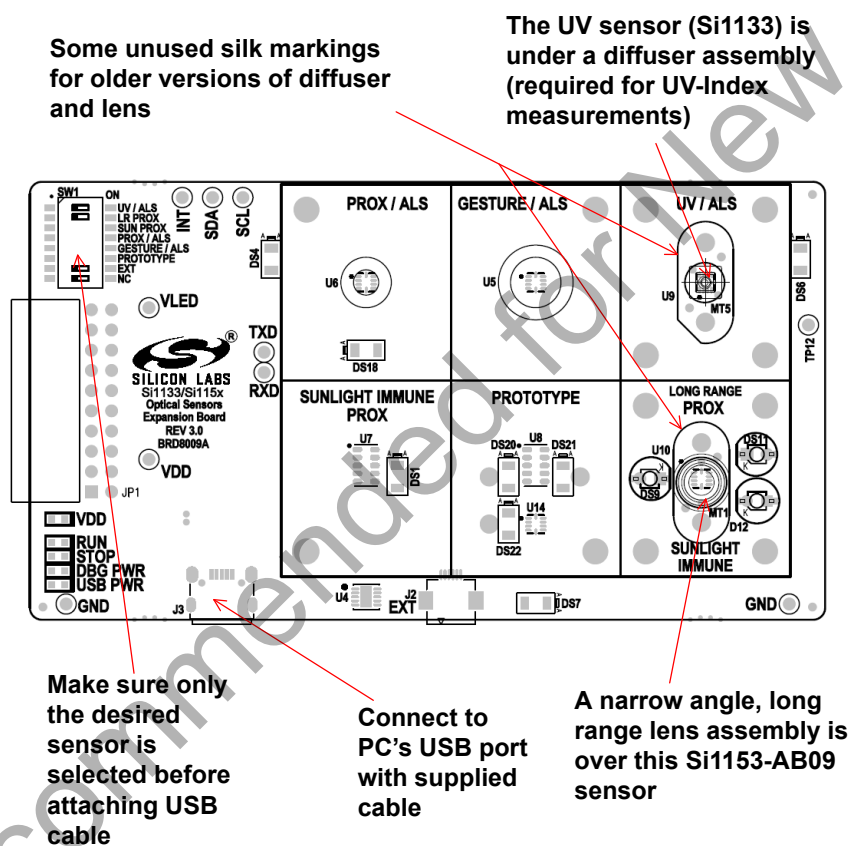

Figure 2.1. Board Setup for UV/ALS and Optical Programmer's Toolkit Using a USB Port

2.3 Installation and Use of the Optical Programmer's Toolkit

Go to the [Silicon Labs website](https://www.silabs.com), search for the Si1153 part and then download and install Rev 4.0 (or higher) of the Si1153/Si1133 Optical Sensors Expansion Board GUI from the Technical Resources section.

Note: In some installations, the application will not launch from the desktop icon of the Start menu but will launch from a windows explorer browser launching the executable, which is typically: C:\SiliconLabs\Optical_Sensors\Si115x\executable\launcher\Si115x GUI.exe.



Figure 2.2. Main Panel of the Si1153/Si1133 Optical Sensors Expansion Board GUI

After launch, select one of the demo types (UV and ALS Demo, for example) in the drop box available in the Si115x main tab, and then select the si115x Control Panel tab to configure one or more of the six measurement channels inside the Si115x part that are available to perform the required task. If the “Launch (any) Demo” button is pressed instead then the control panel is initialized to a “canned” demo and the view is changed to the Waveform viewer.

The si115x control panel is mostly organized in 6 rows and 12 columns. The individual rows correspond to the six measurement tasks that can be programmed to run autonomously inside the part. Each task is run periodically at the sample frequency shown at the top of the dialog box. The information that you enter here is transferred to the Si115x part when the “Commit Settings View waveform” button is pressed. You can alternately use a button in the dialog box to examine the register setting thus created in the form of C sample code for sending the values over.

The seven columns on the left let you set up the tasks with the measurement conditions while the next two columns show the mean and standard deviation of the resulting measurement. The measurement conditions you can set up include the selection of which photodiode to use, the integration time, range, and the current in each of the three LEDs. The statistics are computed on a sliding window of the data output on the sensor, which introduces delay during transient conditions. This is an artifact of the GUI software and not of the sensor itself.

The final three columns allow you to enable some in part software accumulation of readings and right shifting to prevent overflow.

If you click on the “Commit settings View Waveform” button, the setup shown will be transferred to the part and you will be transferred to the Waveform viewer tab.

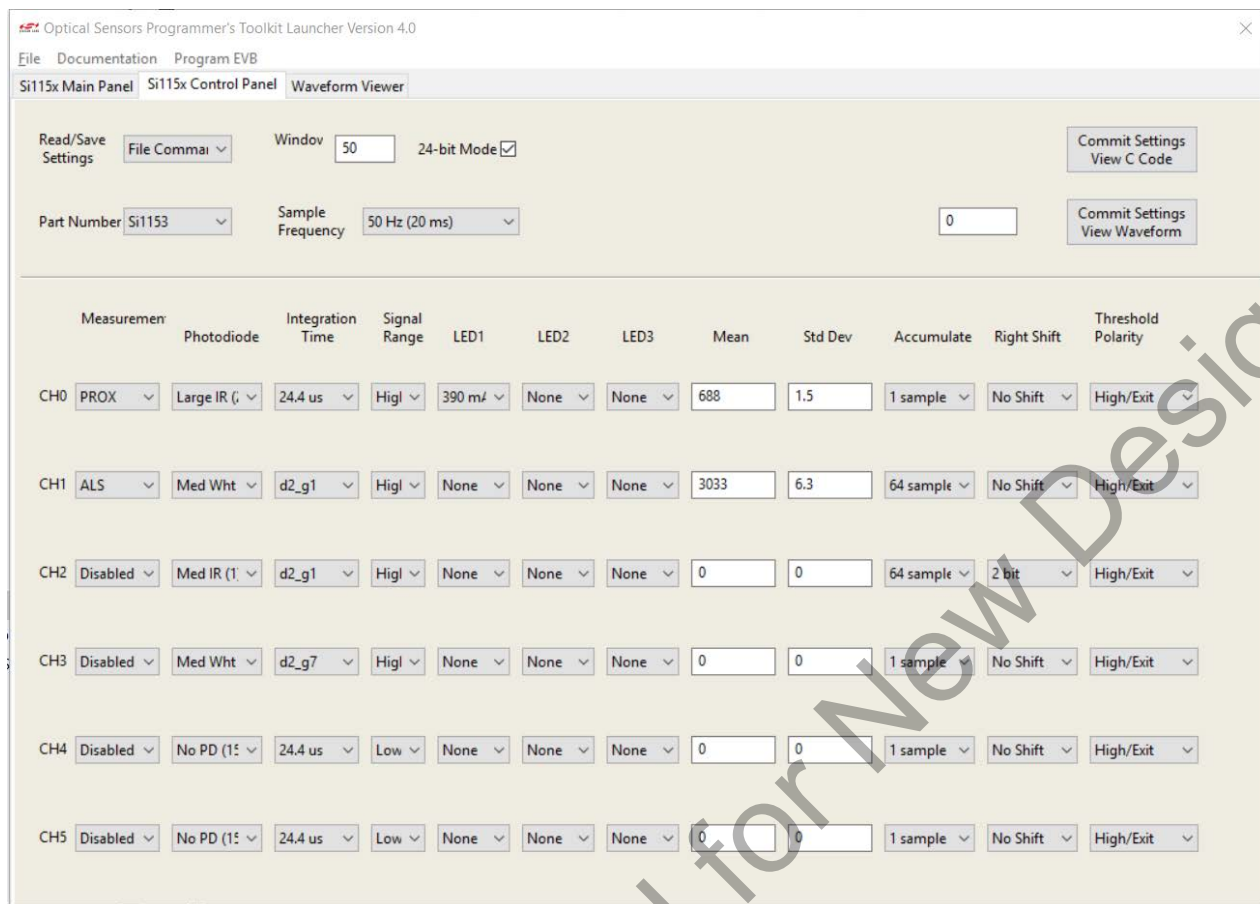

Figure 2.3. Si115x Control Panel

The waveform viewer tab shows all channels selected to operate and allows the user to set the scaling manually or let it run automatically. See the figure below.

This figure shows one ALS (ambient light sensing) channel and one proximity channel. During the operating a hand was passed over the board and ALS sensor output (red) dropped while the proximity sensor output (green) increased.

This viewer is very useful for evaluating how the part would behave in a real product and we urge customers to add their own overlays or optics to this board and then use this application to see what kind of optical signal their system would see. The raw data recorded is as shown below.

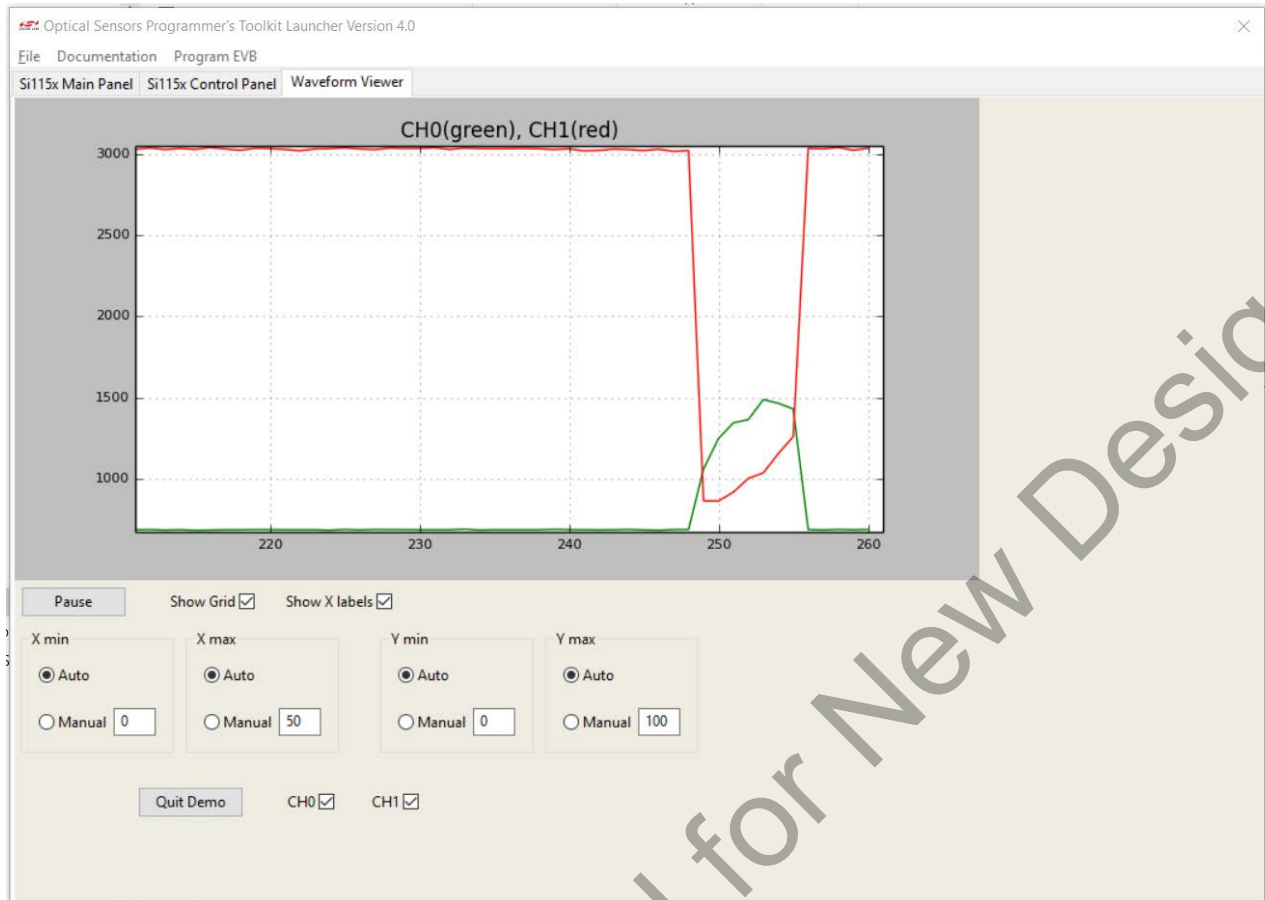

Figure 2.4. Waveform Viewer Tab

3. The Five Sensors on the EVB

3.1 UV/ALS

The Si1133 sensor is mounted with a demonstration Teflon light diffuser assembly. The diffuser holder is made from carbon filled black material and has a 1.2 mm diameter opening for light to reach the sensor while the 0.1 mm thin Teflon diffuser is a 2.3 x 2.3 mm square that covers that opening.

This 1.2 mm circle at the back of the diffuser is illuminated by sunlight from the top at all angles but this circle is only visible to the UV sensor in the Si1133 package from a narrow angle of ± 25 degrees.

This design approach is critical to the accuracy of the UV sensor and this sensor should not be used without a carefully positioned diffuser that uses a similar approach. Alternate diffusers can be much larger as it's the angles that matter. For example, a 1.2 meter diffuser can be used as long as it is 1 meter above the Si1133 sensor.

See the drawings below for construction details of the diffuser used in this EVB.

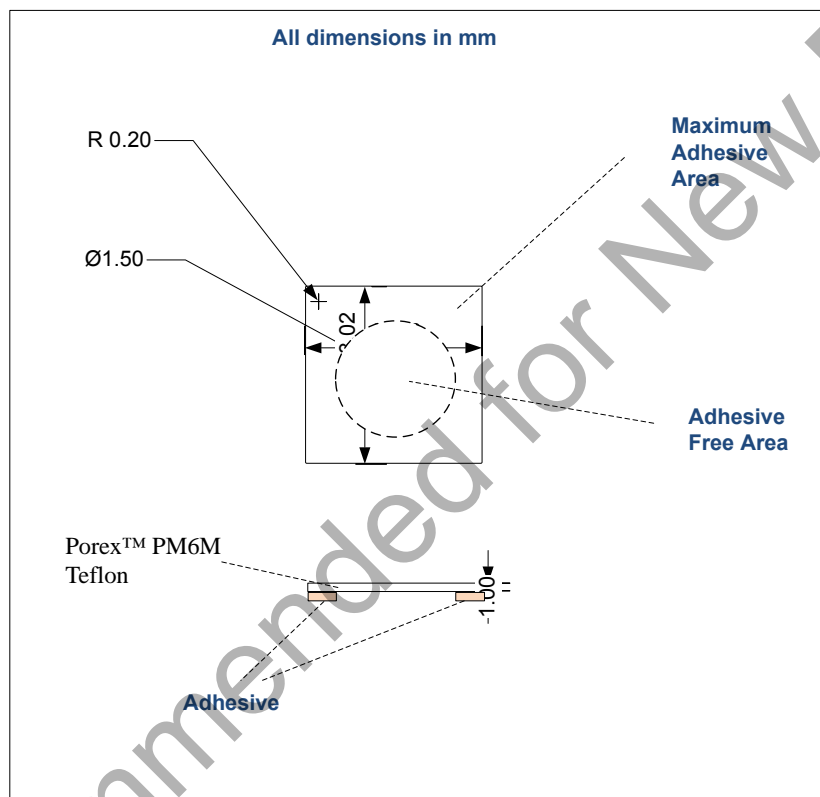

Figure 3.1. Teflon Diffuser Drawing

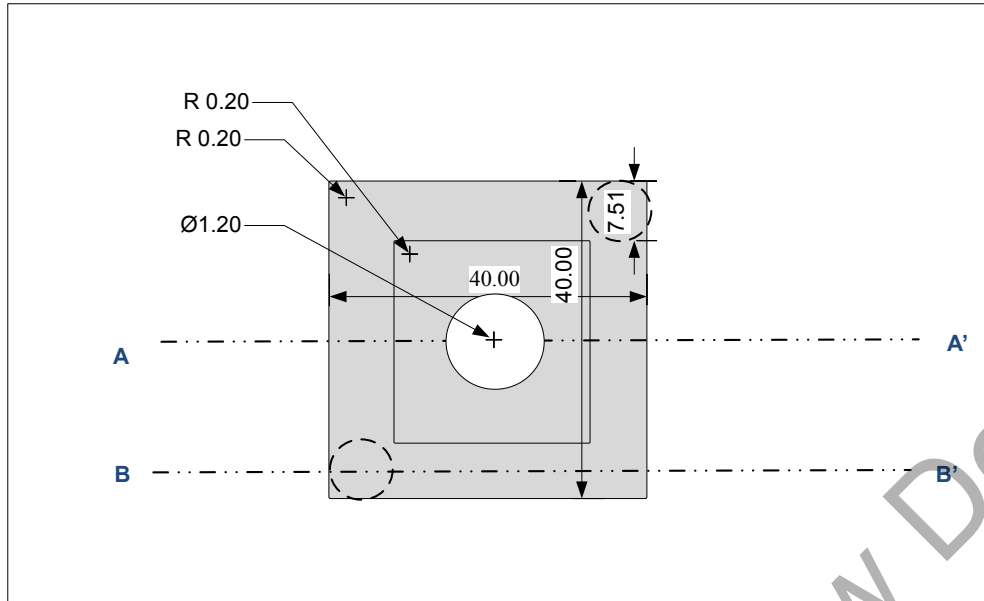

Figure 3.2. Diffuser Holder Top View

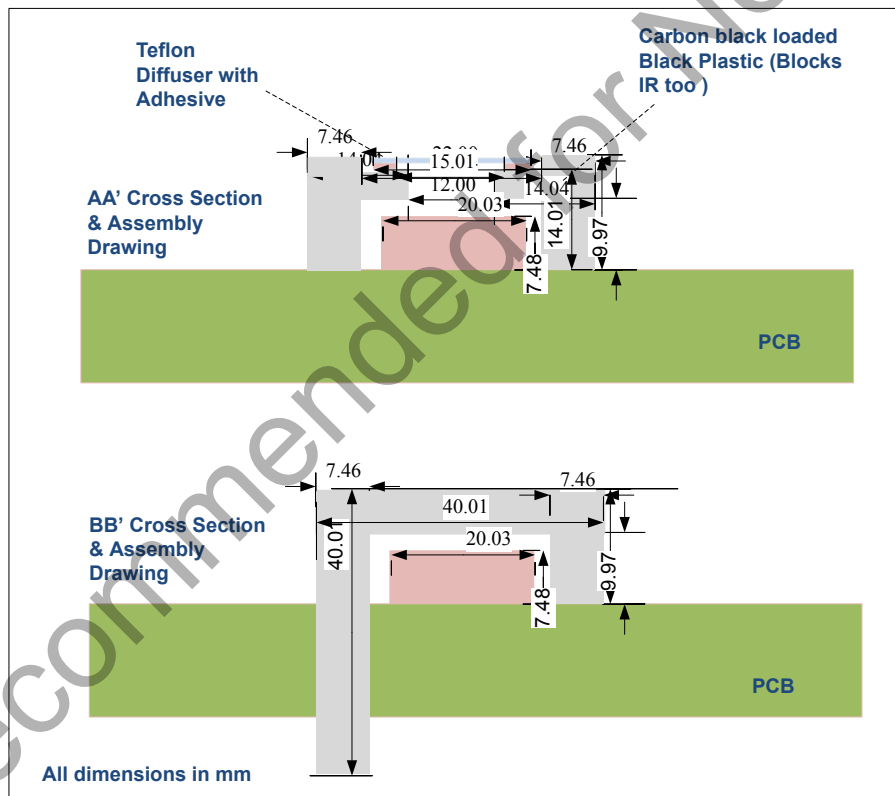

Figure 3.3. Diffuser Holder Side Views

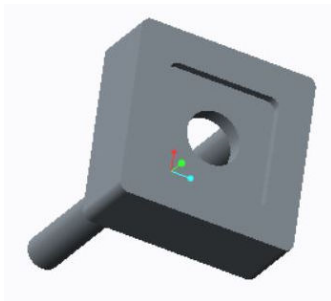

Figure 3.4. 3D View of Teflon Diffuser Holder

The Teflon used is Porex™ PM6M material. For fabrication of Teflon into a convenient glue-on, contact:

Craig Carroll

Sales Manager

Marian Fort Worth

1501 Northpark Dr.

Fort Worth, TX 76102

(817) 332-6151 x167

Not Recommended for New Designs

3.2 Long Range Proximity

The Si1153-AB09 2 x 2 mm is a proximity sensing chip with an on-die 940 nm bandpass filter for sunlight immunity. The board demonstrates the use of a 5 mm diameter lens and narrow-angle LED.

The 940 nm filter on the die and external LED are selected to coincide with a dip in solar energy that occurs around 940 nm. One gets the advantage of rejecting visible and IR light by a couple of orders of magnitude and operating in a safe area with minimal sun energy.

The lens mounted over the sensor is designed to give the sensor a roughly ± 5 degree field of view. The same is true for the lensed LED used on the EVB with this sensor.

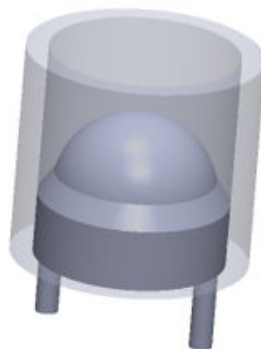

Figure 3.5. 3D View of Half-Ball Lens with Holder and Blocker for Long Distance Proximity and Sensing

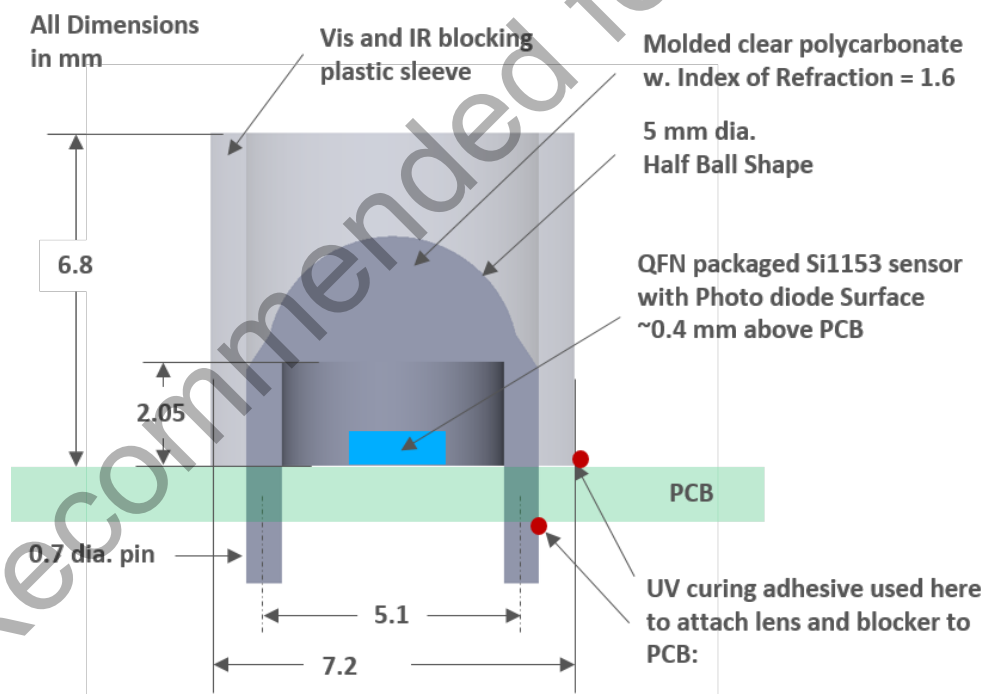

Figure 3.6. Cross Section of Molded Half Ball Lens for Long Range Proximity Sensing

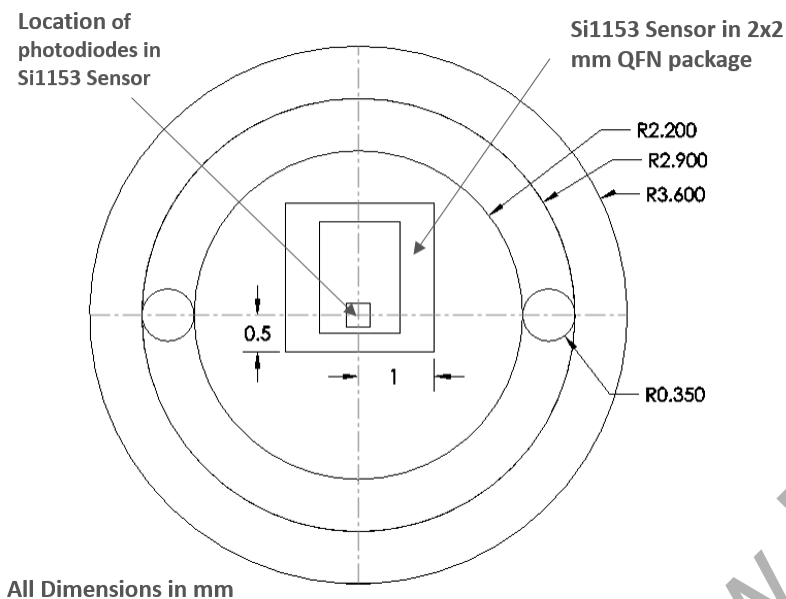

Figure 3.7. Bottom View of Relative PCB Location of Lens Assembly and Si115x Sensor

3.3 Sunlight-Immune Proximity Module

A Si1153-AB9X, 2.85 X 4.9 mm proximity sensing module with an on-die 940 nm bandpass filter for sunlight immunity and an integrated 940 nm LED is mounted on the board.

The 940 nm filter on the die and matching LED are selected to coincide with a dip in solar energy that occurs around 940 nm. One gets the advantage of rejecting visible and IR light by an order of magnitude and operating in a safe area with minimal sun energy. The module integrates an optimized LED to provide simple component selection and ease of manufacturing.

3.4 Proximity/ALS

The Si1153-AB00, 2 x 2 mm light sensor chip is mounted with a nearby 850 nm LED to demonstrate simple ALS and proximity measurements.

3.5 Gesture/ALS

The Si1153-AB00 2 x 2 mm light sensor chip is mounted on the board, while the PCB uses three carefully spaced 850 nm LEDs for to demonstrate gesture operation.

4. Schematics

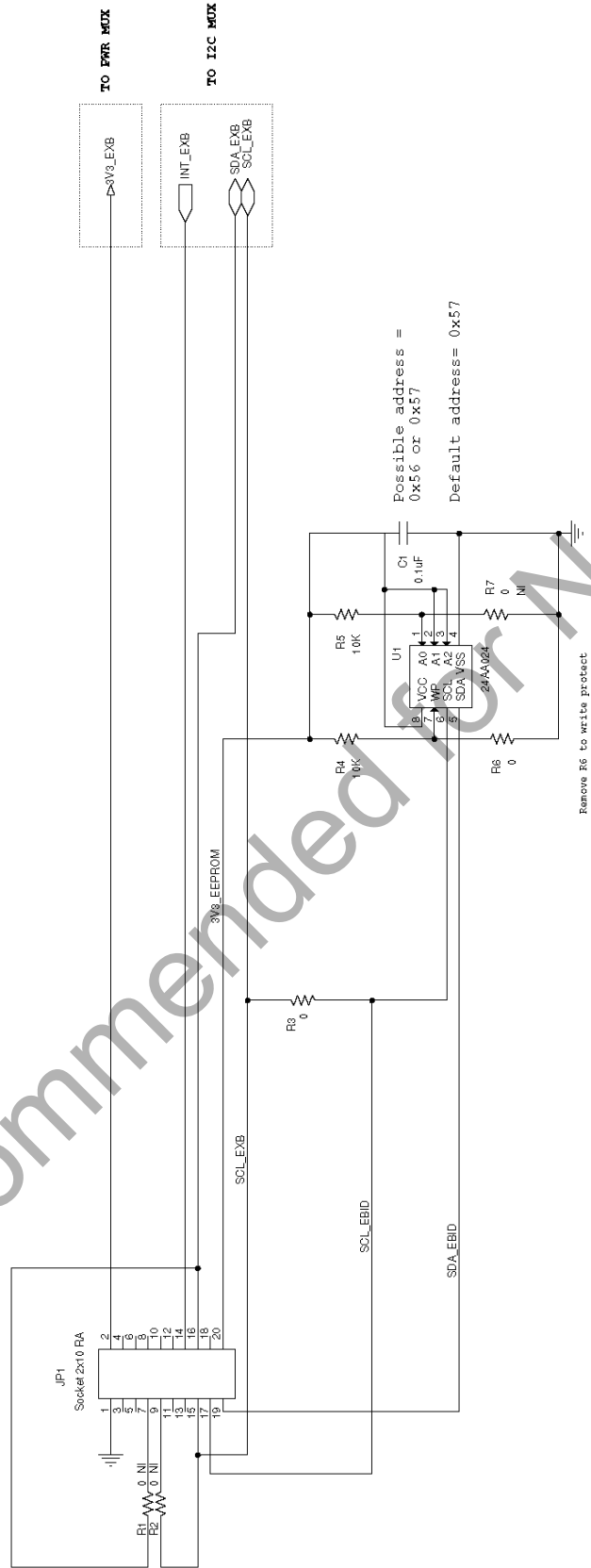

Default Config: See B.3 in t0035_stk_add-on_board_design_guide: Install R3, remove R1 & R2
 Alternate Solution: See B.1 in t0035_stk_add-on_board_design_guide: Install R1 & R2 Remove R3

Figure 4.1. Schematic Page 1: Interface to the Gecko EVB Expansion Port

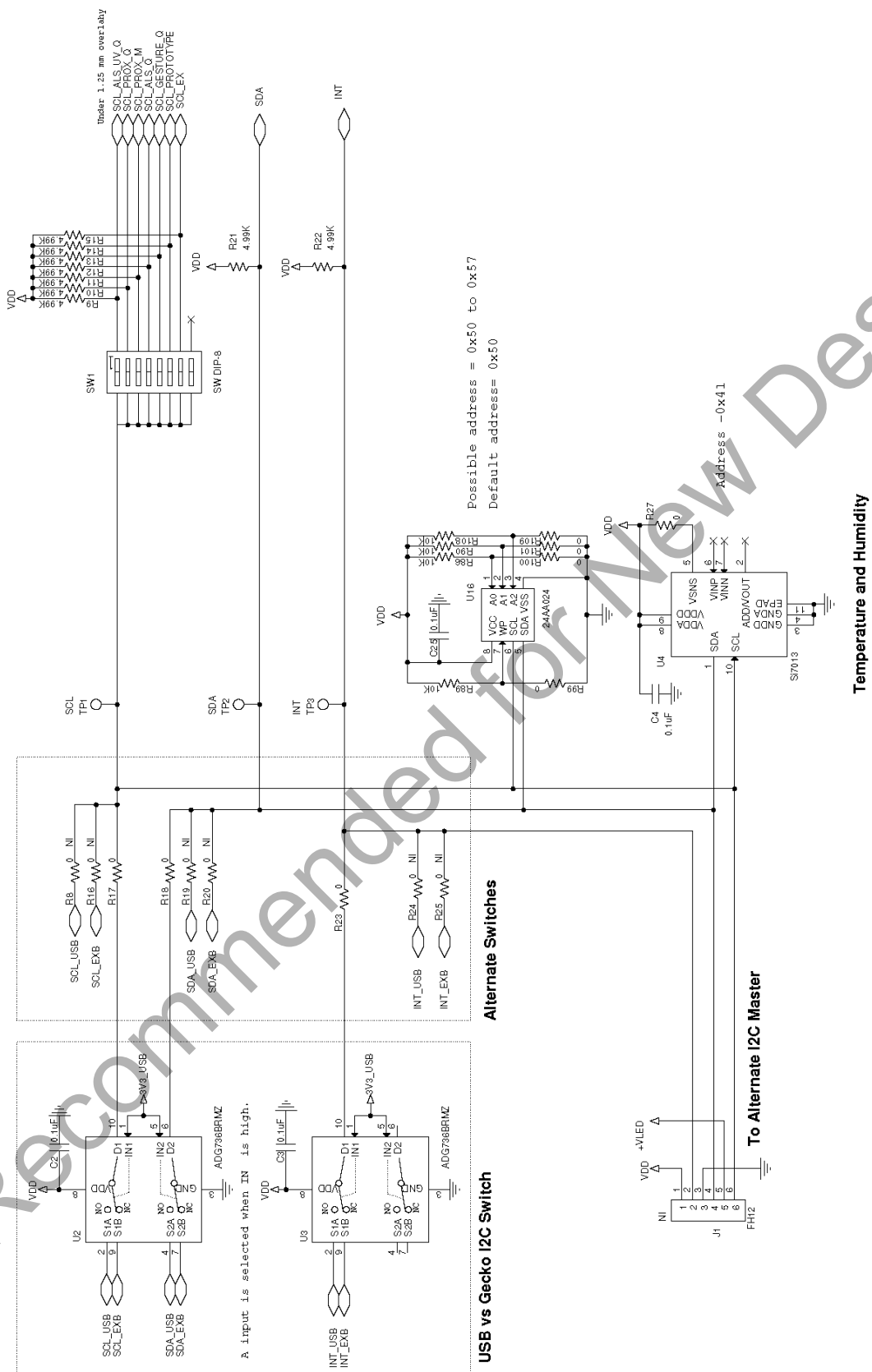

Figure 4.2. Schematic Page 2: I²C MUX, Sensor Selector Switch and Temperature/Humidity Sensor

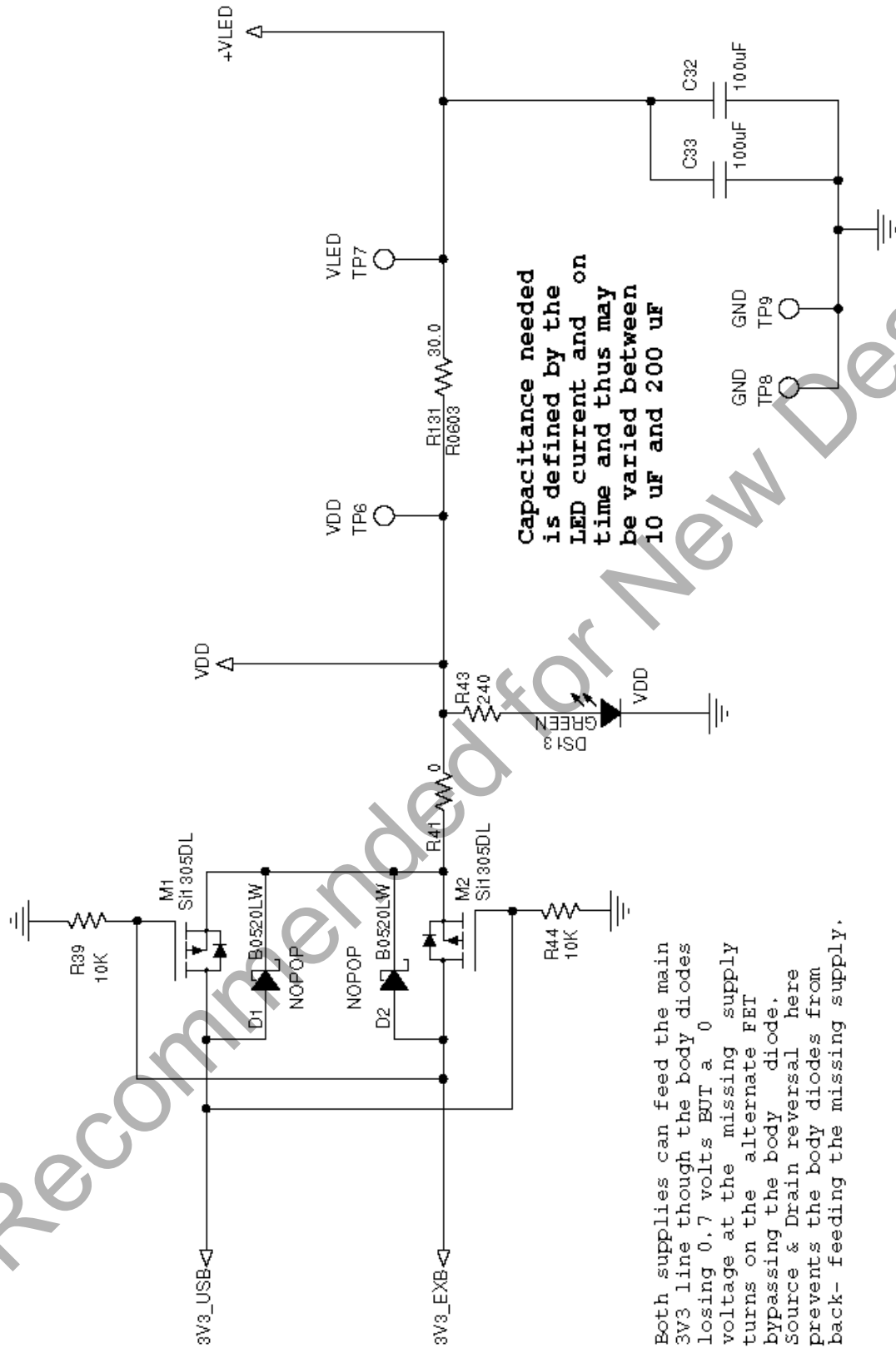

Figure 4.4. Schematic Page 4: Power Supply MUX and the VLED Up Converter

Note: Note that the up-converter is only needed if the VDD is less than 3.3 V. It is provided here for convenience if the user wants to evaluate operation with this converter.

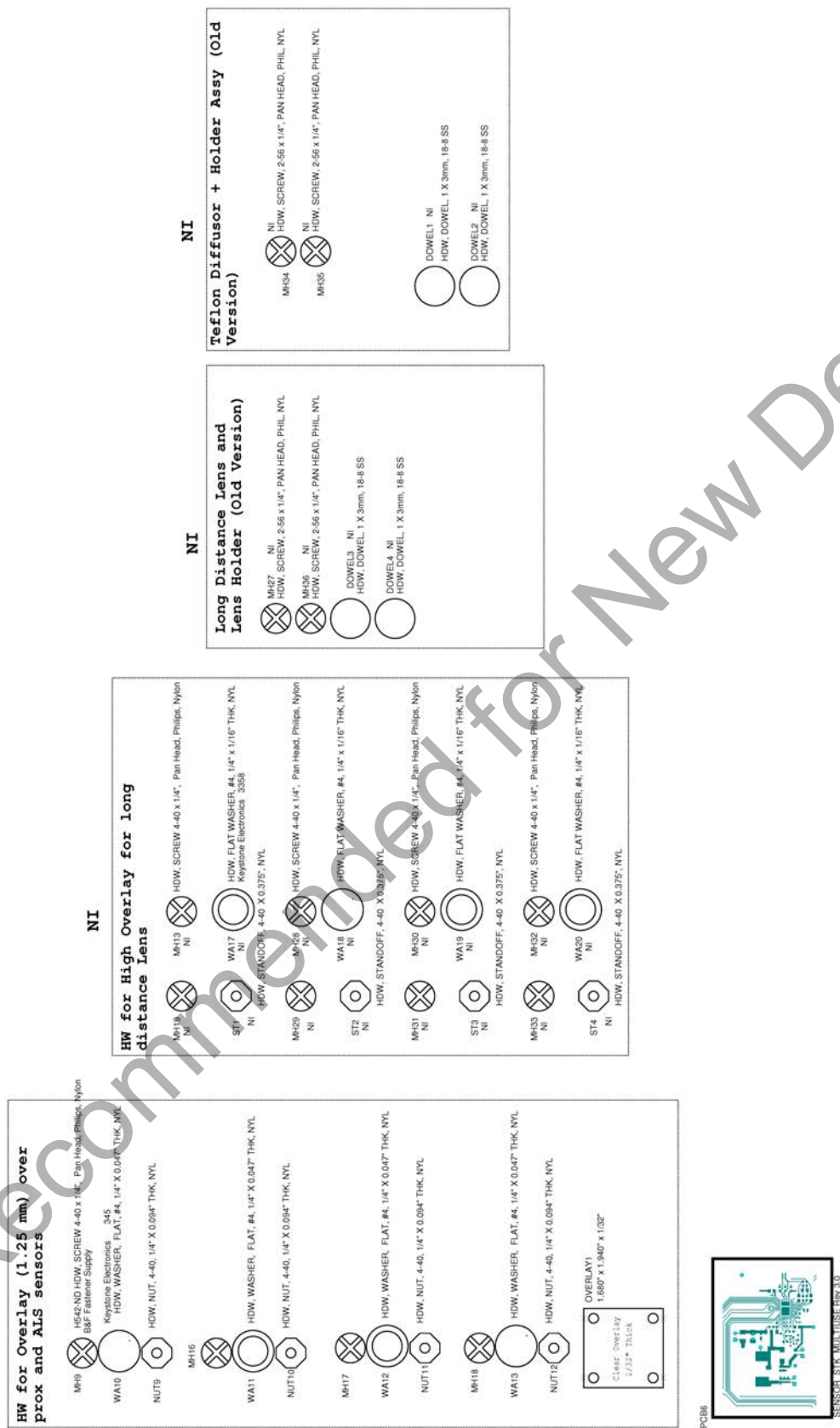

Figure 4.6. Schematic Page 6:

5. PCB Layout

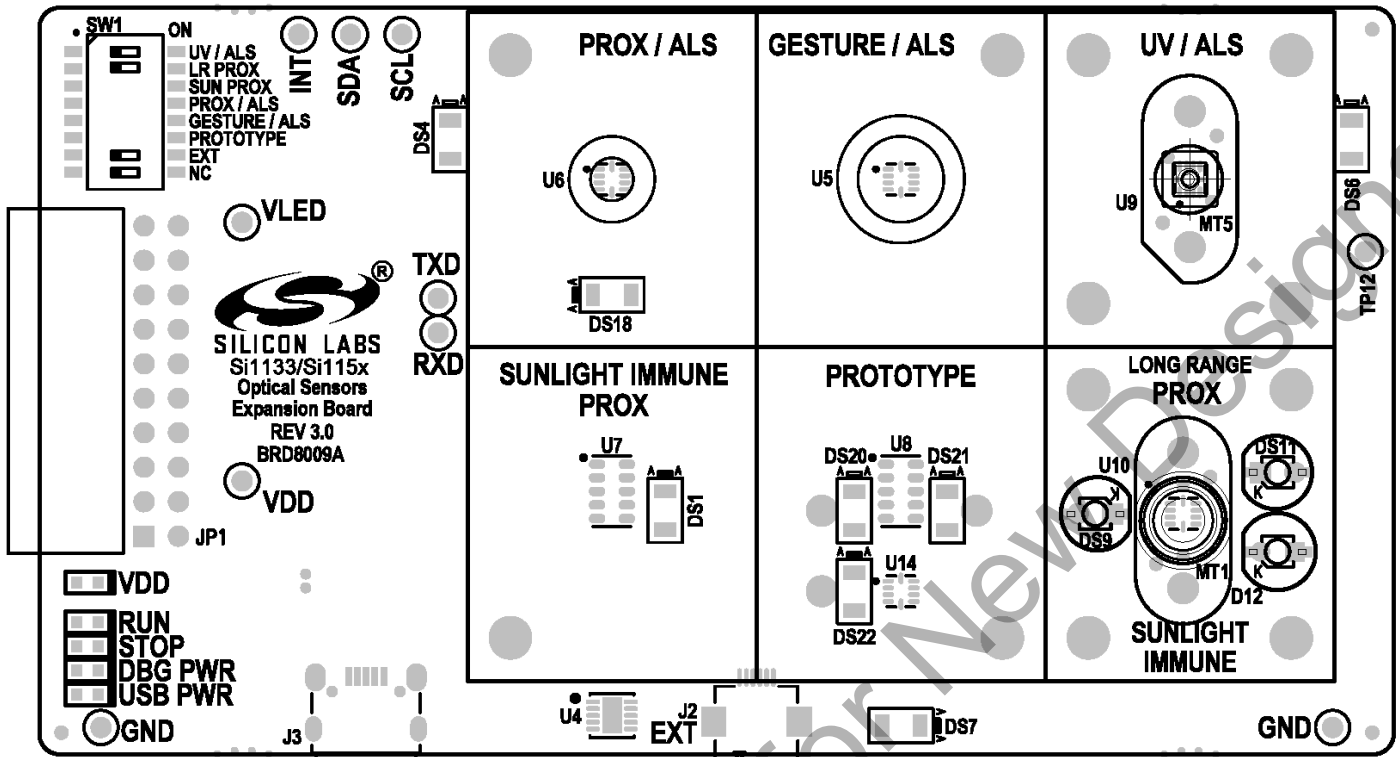

Figure 5.1. Primary Silk Screen

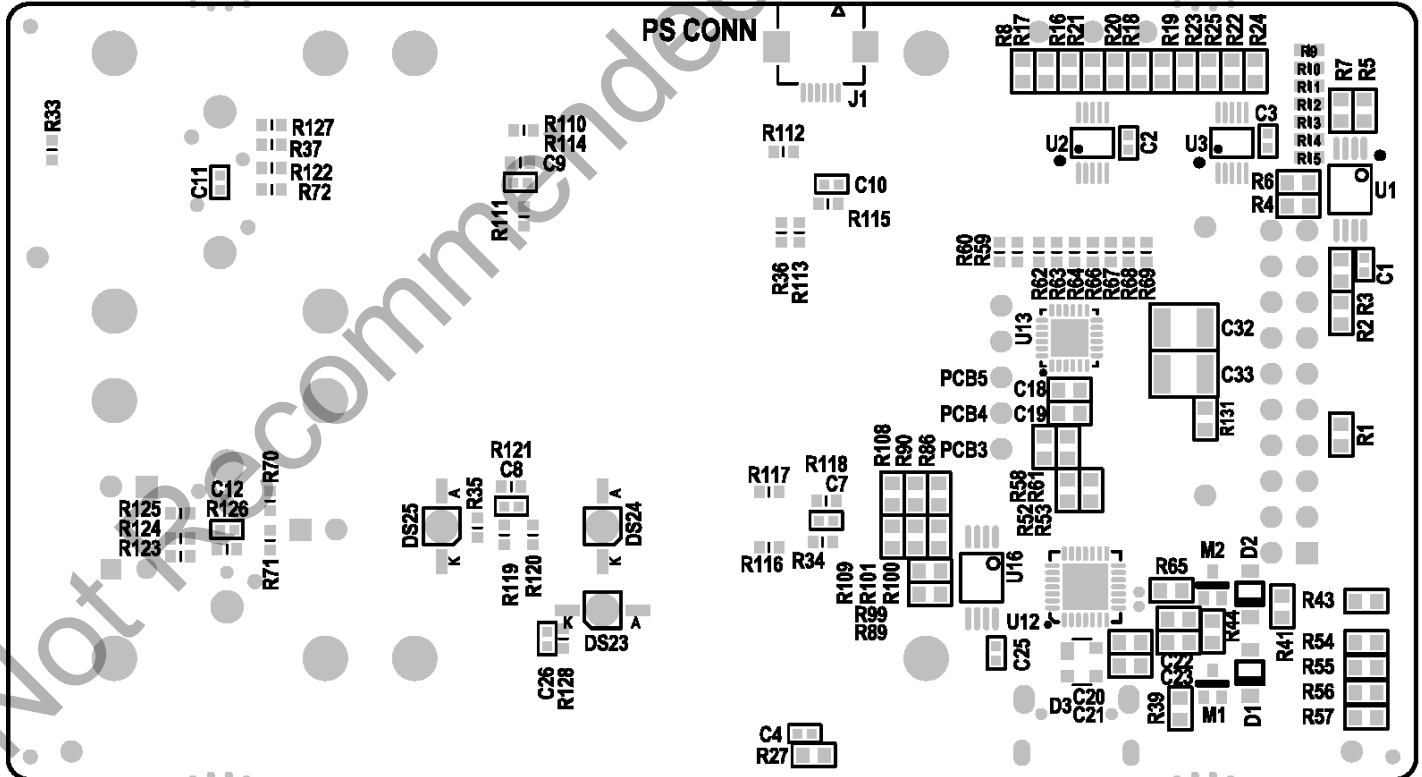

Figure 5.2. Secondary Silk Screen

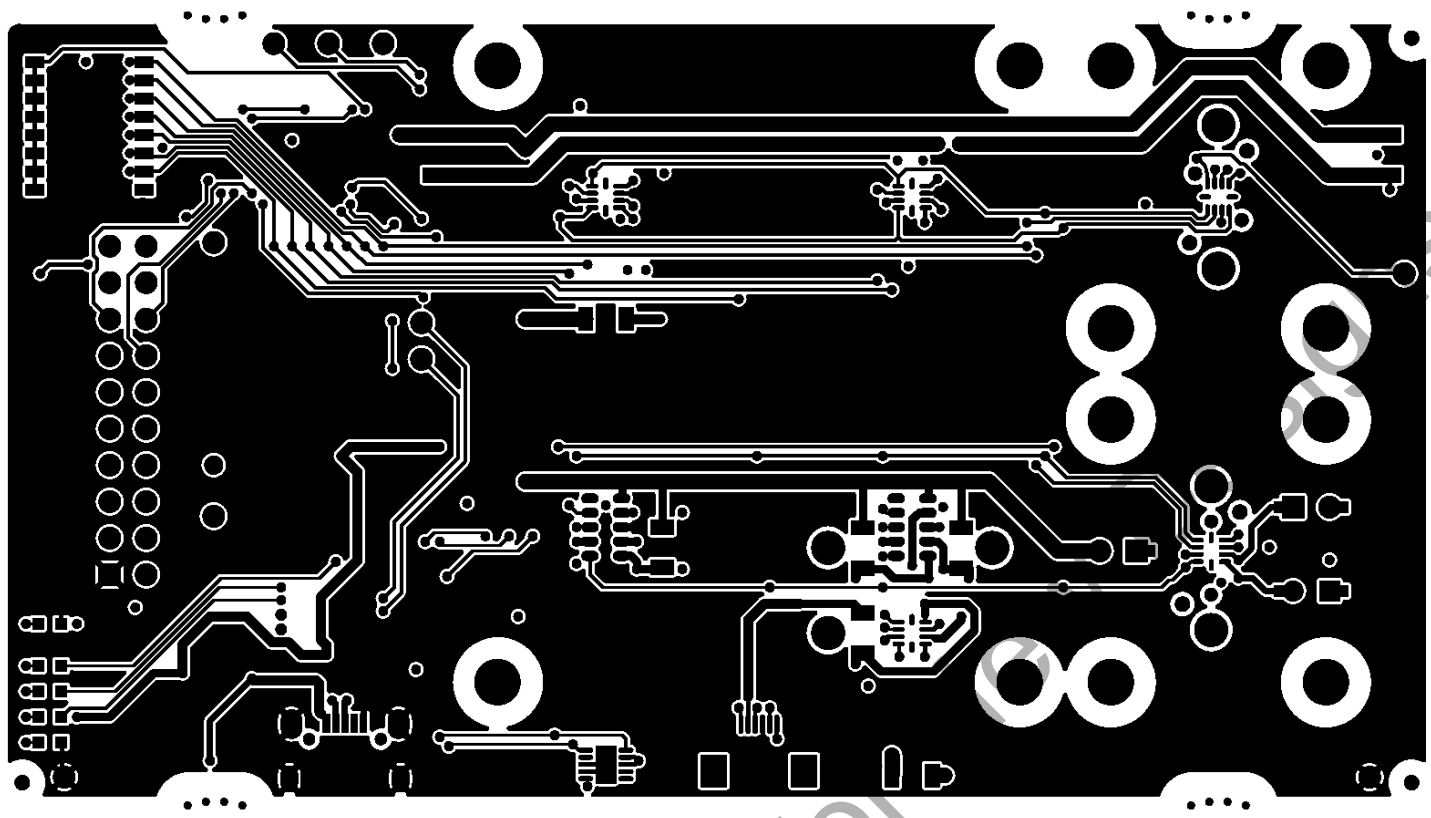

Figure 5.3. Primary Copper Layer

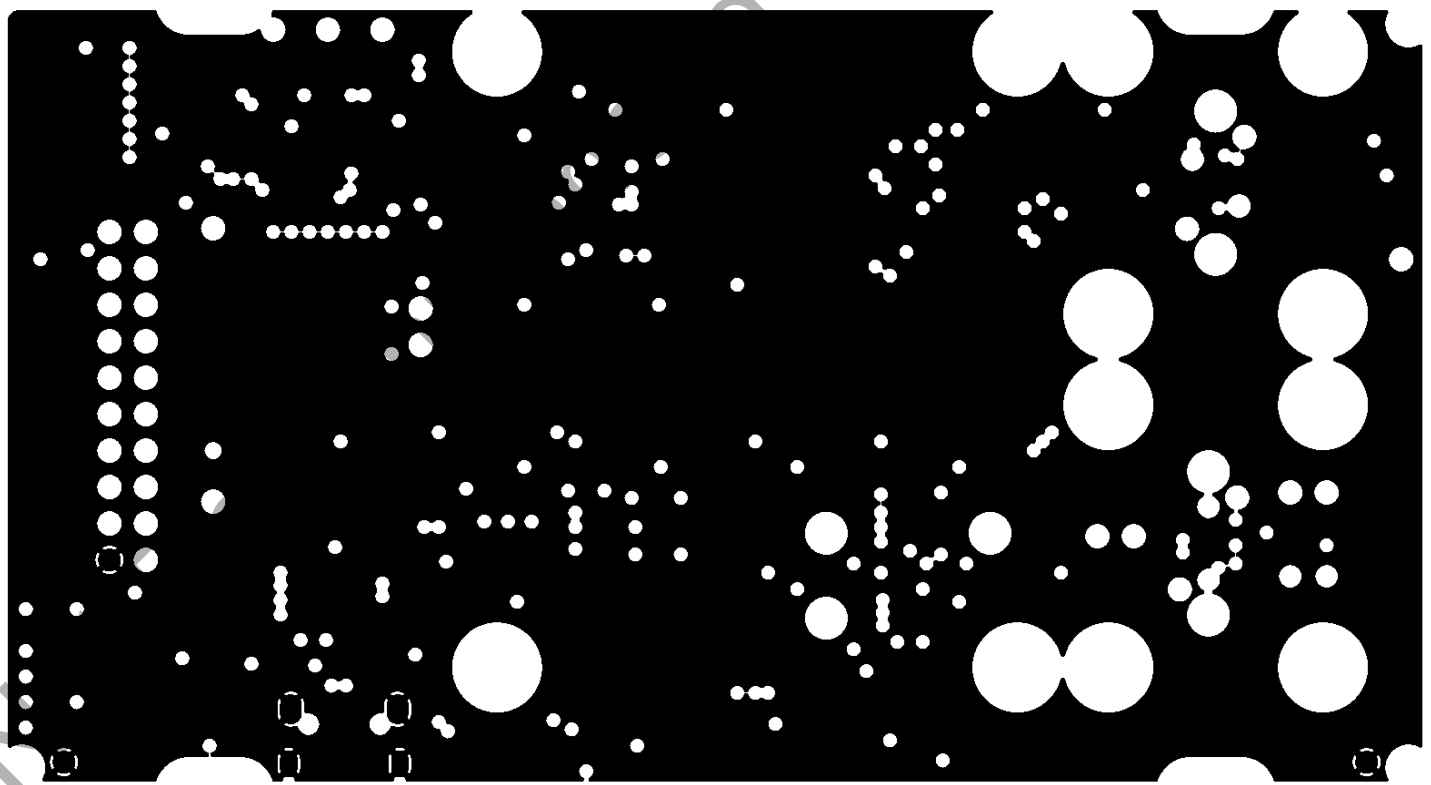

Figure 5.4. Copper Layer 2

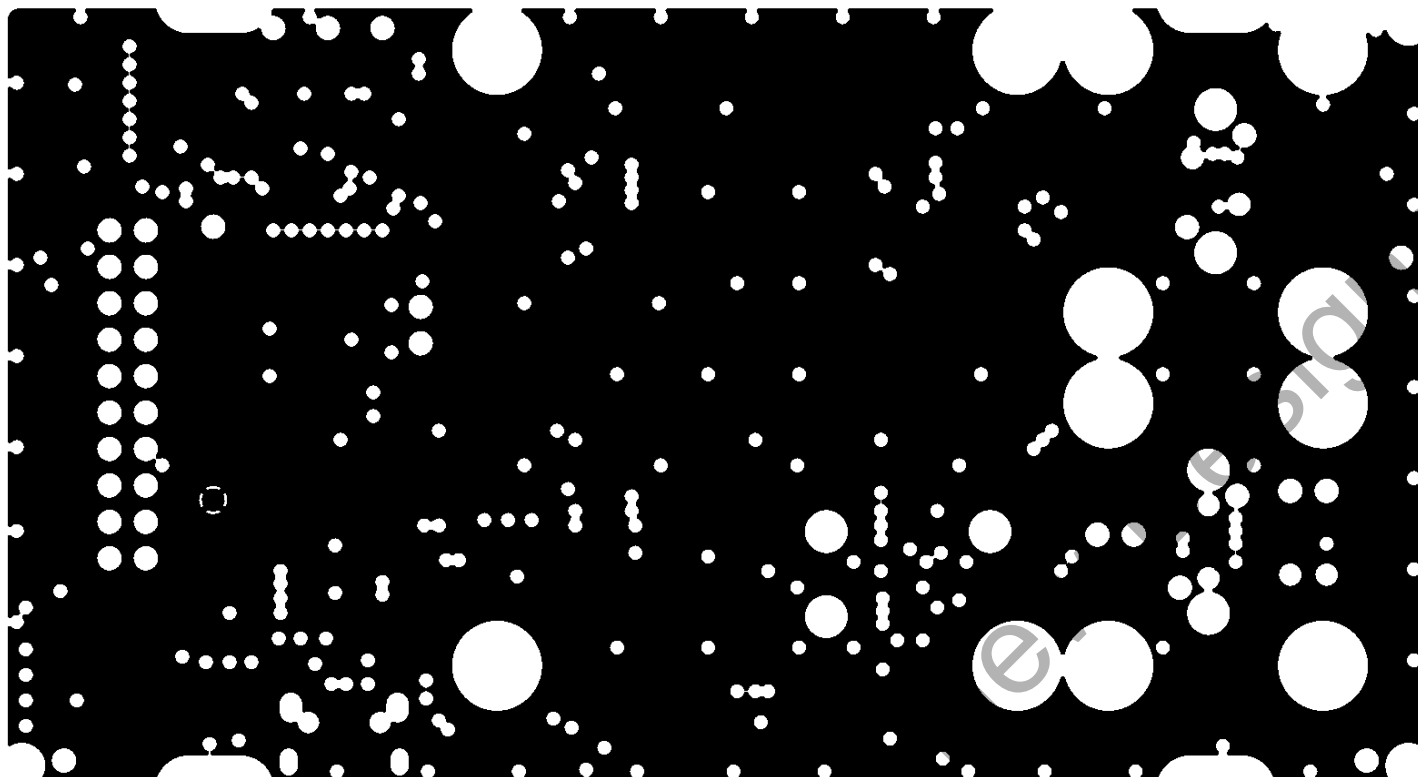

Figure 5.5. Copper Layer 3

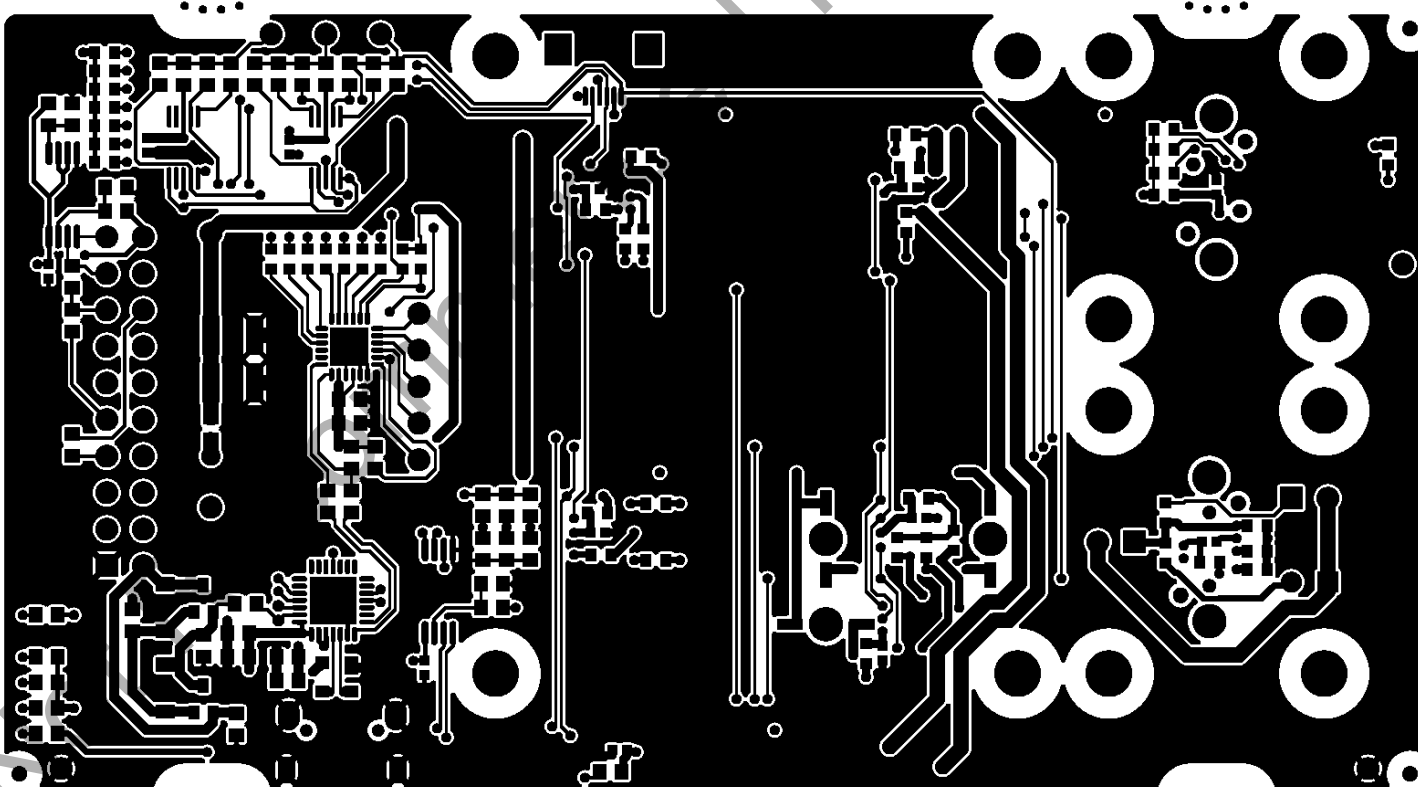

Figure 5.6. Copper Secondary Layer

6. Bill of Materials

Table 6.1. Si1133/Si115x-EVB Bill of Materials

Qty	Reference	Value	Description	PCB Footprint	Mfr Part Number	Mfr
12	C1, C2, C3, C4, C7, C8, C9, C10, C11, C12, C25, C26	0.1 μ F	CAP, 0.1 μ F, 10 V, \pm 10%, X7R, 0402	C0402 C0402L	C0402X7R100-104 K	Venkel
2	C18,C23	1 μ F	CAP, 1 μ F, 10 V, \pm 10%, X7R, 0603	C0603	C0603X7R100-105 K	Venkel
3	C19, C20, C22	0.01 μ F	CAP, 0.01 μ F, 10 V, \pm 20%, X7R, 0603	C0603	C0603X7R100-103 M	Venkel
1	C21	10 μ F	CAP, 10 μ F, 6.3 V, \pm 20%, X5R, 0603	C0603 C0603L	C0603X5R6R3-10 6M	Venkel
2	C32, C33	100 μ F	CAP, 100 μ F, 16 V, \pm 20%, X5R, 1210	C1210	CC1210MKX5R7B B107	Yageo
2	D1, D2	B0520LW	DIO, Schottky, 20 V, 500 mA, SOD123	SOD-123	B0520LW-7-F	Diodes Inc.
1	D12	IR 940 nm	LED, IR, 940 nm, 8.3 mm high \pm 5 deg, PHT	LED-T1-3/4-IR	SFH4545	OSRAM
1	D3	SP0503BAH T	Diode Array, TVS Avalanche	SOT143-AK SOT143	SP0503BAHTG	Littlefuse
1	DS1	940 nm	LED, IR, 940 nm, 1.1 mm high, \pm 22 deg, 1206	LED-1206-A	SFH 4046	OSRAM
2	DS13, DS14	Green	LED, Green, 571 nM, 20 mA, 2 V, 35 mcd, 0603	LED0603-KA	LTST-C190KGKT	LITE-ON TECHNOLOGY CORP
2	DS15, DS17	Red	LED, RED, 631 nM, 20 mA, 2 V, 54 mcd, 0603	LED0603-KA	LTST-C190KRKT	LITE-ON TECHNOLOGY CORP
1	DS16	Yellow	LED, Yellow, 589 nM, 20 mA, 2 V, 104 mcd, 0603	LED0603-KA	LTST-C190KSKT	LITE-ON TECHNOLOGY CORP
4	DS4, DS6, DS7, DS18	SFH 4056	LED, Infrared, 850 nm, 22 degree, Anode Mark, 1206	LED-1206-A	SFH 4056	OSRAM Opto Semiconductors Inc
1	J2	FH12	CONN, 6-Pin , FPC/FFC, Bottom Contact, 0.5 mm Pitch, SMD	CONN6N-FPC/FFC-P0.5	FH12-6S-0.5SH(55)	HIROSE
1	J3	USB-MICRO-B-RA	CONN, RECEPT MICRO B, USB2.0 5POS, RA, SMD/PTH	MICRO-USB-PTH-WURTH	629105150521	WURTH
1	JP1	Socket 2x10 RA	CONN, Socket, 2x10, Right Angle, 0.1 in pitch, 20 u Au Plated	CONN2X10-FRA	SSW-110-02-G-D-RA	Samtec
2	M1, M2	Si1305DL	Transistor, MOSFET, P-CHNL, -8 V, -0.86 A, SOT323	SOT323-GSD	Si1305DL	Vishay

Qty	Reference	Value	Description	PCB Footprint	Mfr Part Number	Mfr
4	MH9, MH16, MH17, MH18	4-40	HDW, Screw 4–40 x 1/4", Pan Head, Philips, Nylon	MH-125NP	H542-ND	B&F Fastener Supply
1	MT4	5 mm	5 mm Polycarbonate Lens and Holder	SI1153-LD-LENS-5MM	5mmPolyuLensAndHolder	Andrew Lau
1	MT5	4x4 mm	Light Diffuser Assembly	TEFLON_DIFFUSER_4MM	TEFLON_DIFFUSER_4MM	Marion Fort Worth and Andrew Lau
4	NUT9, NUT10, NUT11, NUT12	4–40	HDW, NUT, 4–40, 1/4" X 0.094" THK, NYL		H616-ND	B&F Fastener
1	OR1	AS568-006S	HDW, O-RING, Buna-N, 1/4 OD, 1/8 ID, 1/16 WD, SQ, AS568-006S	O-RING_AS568-006S	4061T111	McMaster-Carr
1	OR2	AS568-010S	HDW, O-RING, Buna-N, 3/8 OD, 1/4 ID, 1/16 WD, SQ, AS568-010S	O-RING_AS568-010S	4061T115	McMaster-Carr
1	OVERLAY1	1.680" x 1.940" x 1/32"	HDW, Overlay, Lexan, 1.680" x 1.940" x 1/32", Clear, 0.125" dia holes 0.125" from corners		SIL-0002-0001	Ampco
1	PCB6	SENSOR_STK_MULTIIUSE Rev 3.0	PCB, Bare Board, SENSOR_STK_MULTIIUSE Rev 3.0	N/A	SENSOR_STK_MULTIIUSE Rev 3.0	Silicon Labs
1	R131	30.0	Resistor, 30.0 Ω , 1/10 W, $\pm 1\%$, Thick-Film, 0603	R0603 R0603L	CR0603-10W-30R0F	Venkel
29	R3, R6, R17, R18, R23, R27, R41, R52, R53, R62, R63, R64, R66, R67, R68, R69, R70, R71, R72, R99, R100, R101, R109, R114, R115, R118, R121, R126, R128	0 Ω	Resistor, 0 Ω , 1 A, ThickFilm, 0603	R0603 R0603L	CR0603-16W-000	Venkel
18	R33, R34, R35, R36, R37, R110, R111, R112, R113, R116, R117, R119, R120, R122, R123, R124, R125, R127	100 k Ω	Resistor, 100 k Ω , 1/16 W, $\pm 5\%$, Thick-Film, 0603	R0603	CR0603-16W-104J	Venkel
8	R4, R5, R39, R44, R86, R89, R90, R108	10 k Ω	Resistor, 10 k Ω , 1/10 W, $\pm 5\%$, Thick-Film, 0603	R0603	CR0603-10W-103J	Venkel
2	R43, R54	240 Ω	Resistor, 240 Ω , 1/16 W, $\pm 1\%$, Thick-Film, 0603	R0603	CR0603-16W-2400F	Venkel
1	R55	332 Ω	Resistor, 332 Ω , 1/10 W, $\pm 1\%$, Thick-Film, 0603	R0603	CR0603-10W-3320F	Venkel

Qty	Reference	Value	Description	PCB Footprint	Mfr Part Number	Mfr
1	R56	649 Ω	Resistor, 649 Ω , 1/10 W, $\pm 1\%$, Thick-Film, 0603	R0603	CR0603-10W-6490 F	Venkel
1	R57	1 k Ω	Resistor, 1 k Ω , 1/16 W, $\pm 1\%$, ThickFilm, 0603	R0603	CR0603-16W-1001 F	Venkel
3	R58, R59, R60	24.3 k Ω	Resistor, 24.3 k Ω , 1/16 W, $\pm 1\%$, Thick-Film, 0603	R0603	CR0603-16W-2432 F	Venkel
2	R61, R65	2 k Ω	Resistor, 2 k Ω , 1/10 W, $\pm 1\%$, ThickFilm, 0603	R0603	CR0603-10W-2001 F	Venkel
9	R9, R10, R11, R12, R13, R14, R15, R21, R22	4.99 k Ω	Resistor, 4.99 k Ω , 1/16 W, $\pm 1\%$, Thick-Film, 0603	R0603	CR0603-16W-4991 F	Venkel
1	SW1	SW DIP-8	Switch, DIP, 8 POS, SMT, 0.050 in Pitch, ROHS	SW8-DIP-SMT	TDA08H0SB1R	CTS
8	TP1, TP2, TP3, TP6, TP7, TP8, TP9, TP12	Black	Testpoint, Black, PTH	TEST-POINT	151-203-RC	Kobiconn
2	U1, U16	24AA024	IC, EEPROM, 2K (256 x 8bit), I ² C, 100 kHz, TSSOP8	TSSOP8N6.4P0.65	24AA024-I/ST	Microchip
1	U10	Si1153-AB09	IC, Sunlight-Rejecting Proximity Sensor, I ² C, QFN10	QFN10M2X2P0.5	Si1153-AB09-GMR	Silicon Labs
1	U12	CF326-SX0261GM	IC, MCU with C2 Debug Program, QFN28	QFN28N5X5P0.5	CF326-SX0261GM	Silicon Labs
1	U13	C8051F931	IC, MCU, 25 MIPS, 16 k Flash, Mixed-Signal ISP, QFN24	QFN24N4X4P0.5	C8051F931-GM	Silicon Labs
2	U2 U3	ADG736BRMZ	IC, CMOS Low Voltage 2.5 O Dual SPDT Switch, MSOP10	SOP10N4.9P0.5	ADG736BRMZ	Analog Devices
1	U4	Si7013	IC, Sensor, Humidity, DFN10	DFN10M3X3P0.5E1.4X2.6	Si7013-A20-GM1	Silicon Labs
2	U5 U6	Si1153-AB00	IC, ALS and Proximity Sensor, I ² C, QFN00	QFN10M2X2P0.5	Si1153-AB00-GMR	Silicon Labs
1	U7	Si1153-AB9X	IC, Sun-Rejecting Proximity Module, DFN10	DFN10N2.2P1.0-PROX	Si1153-AB9X-GMR	Silicon Labs
1	U9	Si1133-AA00	IC, UV/ALS Sensor, I ² C, QFN10	QFN10M2X2P0.5	Si1133-AA00-GMR	Silicon Labs
4	WA10, WA11, WA12, WA13	Flat Washer #4	HDW, Washer, Flat, #4, 1/4" X 0.047" THK, NYL		345	Keystone Electronics
Not-Installed Components						
4	DOWEL1, DOWEL2, DOWEL3, DOWEL4	1 mm	HDW, DOWEL, 1 x 3 mm, 18-8 SS	RUBBER_FOOT_0.250"	91585A032	McMaster-Carr
3	DS20, DS21, DS22	SFH 4056	LED, Infrared, 850 nm, 22 degree, Anode Mark, 1206	LED-1206-A	SFH 4056	OSRAM Opto Semiconductors Inc.

3	DS23, DS24, DS25	IR 940 nm	LED, IR, 940 nm, 2.77 mm high ± 7 deg, SMD (reverse)	LED-VSMB294008RG-BOT	VSMB294008RG	Vishay
2	DS9, DS11	IR 940 nm	LED, IR, 940 nm, 2.77 mm high ± 7 deg, SMD	LED2N4.2-GW	VSMB294008G	Vishay
1	J1	FH12	CONN, 6-PIN, FPC/FFC, Bottom Contact, 0.5 mm Pitch, SMD	CONN6N-FPC/FFC-P0.5	FH12-6S-0.5SH(55)	HIROSE
8	MH13, MH19, MH28, MH29, MH30, MH31, MH32, MH33	4-40	HDW, Screw 4-40 x 1/4", Pan Head, Philips, Nylon	MH-125NP	H542-ND	B&F Fastener Supply
4	MH27, MH34, MH35, MH36	2-56	HDW, Screw, 2-56 x 1/4", Pan Head, PHIL, NYL	MH-#2	NY PMS 256 0025 PH	B&F FASTENER
9	R1, R2, R7, R8, R16, R19, R20, R24, R25	0	Res, 0 Ω , 1A, ThickFilm, 0603	R0603 R0603L	CR0603-16W-000	Venkel
4	ST1, ST2, ST3, ST4	4-40	HDW, Standoff, 4-40 x 0.375", NYL		8440B	Keystone Electronics
2	TP10, TP11	Black	Testpoint, Black, PTH	TEST-POINT	151-203-RC	Kobiconn
1	U14	Si1153-AB00	IC, ALS and Proximity Sensor, I ² C, QFN00	QFN10M2X2P0.5	Si1153-AB00-GMR	Silicon Labs
1	U8	Ambient Light Sensor	IC, Proximity and Ambient Light Sensor Module, DFN10-Prox	DFN10N2.2 P1.0-PROX	Si1143-M01-GM	Silicon Labs
4	WA17, WA18, WA19, WA20	Flat Washer #4	HDW, Flat Washer, #4, 1/4" x 1/16" THK, NYL		3358	Keystone Electronics

7. Revision History

Revision 0.3

February, 2019

- Changed the lens and holder over the sensor to a molded plastic version that is easier for customers to implement.
- Changed the Teflon diffuser holder placed over the UV sensor to a version that is molded and easier for customers to implement.
- Removed the upconverter circuit that created 5.0 V from 3.3 V for the LED (3.3 Volts is sufficient).
- Changed the Si115x part numbers to match the current firmware rev (e.g., Si1153-AB09 vs. the older Si1153-AA09).

Revision 0.1

December, 2015

- Initial release.

Not Recommended for New Designs

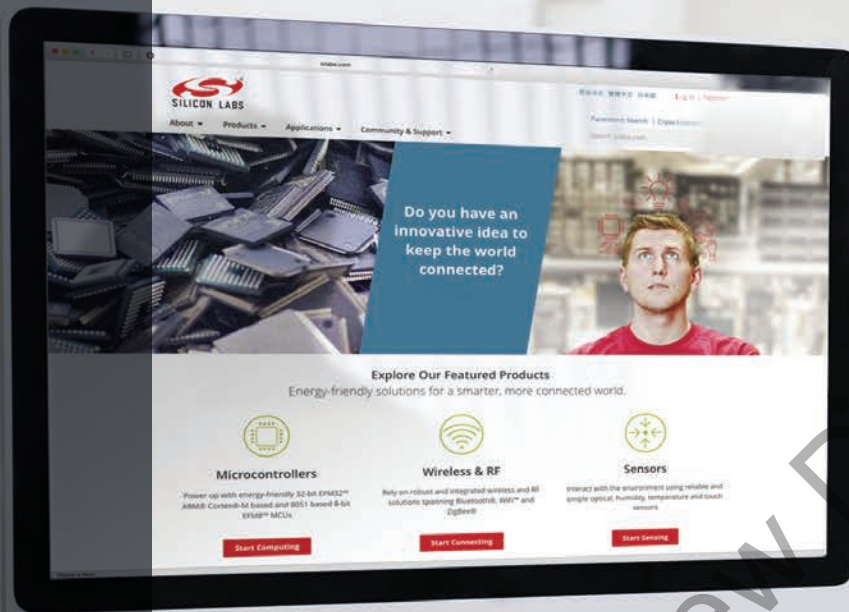

Smart.
Connected.
Energy-Friendly.



Products
www.silabs.com/products

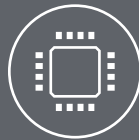

Quality
www.silabs.com/quality



Support and Community
community.silabs.com

Disclaimer

Silicon Labs intends to provide customers with the latest, accurate, and in-depth documentation of all peripherals and modules available for system and software implementers using or intending to use the Silicon Labs products. Characterization data, available modules and peripherals, memory sizes and memory addresses refer to each specific device, and "Typical" parameters provided can and do vary in different applications. Application examples described herein are for illustrative purposes only. Silicon Labs reserves the right to make changes without further notice to the product information, specifications, and descriptions herein, and does not give warranties as to the accuracy or completeness of the included information. Without prior notification, Silicon Labs may update product firmware during the manufacturing process for security or reliability reasons. Such changes will not alter the specifications or the performance of the product. Silicon Labs shall have no liability for the consequences of use of the information supplied in this document. This document does not imply or expressly grant any license to design or fabricate any integrated circuits. The products are not designed or authorized to be used within any FDA Class III devices, applications for which FDA premarket approval is required or Life Support Systems without the specific written consent of Silicon Labs. A "Life Support System" is any product or system intended to support or sustain life and/or health, which, if it fails, can be reasonably expected to result in significant personal injury or death. Silicon Labs products are not designed or authorized for military applications. Silicon Labs products shall under no circumstances be used in weapons of mass destruction including (but not limited to) nuclear, biological or chemical weapons, or missiles capable of delivering such weapons. Silicon Labs disclaims all express and implied warranties and shall not be responsible or liable for any injuries or damages related to use of a Silicon Labs product in such unauthorized applications.

Trademark Information

Silicon Laboratories Inc.®, Silicon Laboratories®, Silicon Labs®, SiLabs® and the Silicon Labs logo®, Bluegiga®, Bluegiga Logo®, Clockbuilder®, CMEMS®, DSPLL®, EFM®, EFM32®, EFR, Ember®, Energy Micro, Energy Micro logo and combinations thereof, "the world's most energy friendly microcontrollers", Ember®, EZLink®, EZRadio®, EZRadioPRO®, Gecko®, ISOModem®, Precision32®, ProSLIC®, Simplicity Studio®, SiPHY®, Telegesis, the Telegesis Logo®, USBXpress® and others are trademarks or registered trademarks of Silicon Labs. ARM, CORTEX, Cortex-M3 and THUMB are trademarks or registered trademarks of ARM Holdings. Keil is a registered trademark of ARM Limited. All other products or brand names mentioned herein are trademarks of their respective holders.



Silicon Laboratories Inc.
400 West Cesar Chavez
Austin, TX 78701
USA

<http://www.silabs.com>

X-ON Electronics

Largest Supplier of Electrical and Electronic Components

Click to view similar products for [Distance Sensor Development Tool](#) category:

Click to view products by [Silicon Labs](#) manufacturer:

Other Similar products are found below :

[SEN0004](#) [MIKROE-2509](#) [172](#) [DFR0315](#) [SEN0006](#) [SEN0007](#) [SEN0008](#) [SEN0187](#) [SEN0202](#) [SEN0208](#) [DM160234](#) [SEN0143](#) [3316](#) [SEN-08504](#) [SEN-08502](#) [DFR0445](#) [3317](#) [984](#) [SEN0014](#) [SEN0001](#) [SEN0171](#) [3942](#) [979](#) [981](#) [982](#) [985](#) [AFBR-S50MV85G-EK](#) [TMF8701-DB](#) [TMF8801-DB](#) [TMF8801-EVM](#) [AD8283CP-EBZ](#) [AD8285CP-EBZ](#) [ADUX1020-EVAL-SDP](#) [SEN0245](#) [EVALBGT24LTR22TOBO1](#) [DM160238](#) [MIKROE-3339](#) [MIKROE-3439](#) [MIKROE-1589](#) [MIKROE-1991](#) [MIKROE-2086](#) [MIKROE-3103](#) [SECO-RANGEFINDER-GEVK](#) [PIM058](#) [PIM062](#) [PIM373](#) [101020083](#) [101020353](#) [101020532](#) [101020617](#)