

PROXIMITY/AMBIENT LIGHT SENSOR WITH PWM OUTPUT

Features

- Typically 50 cm meter proximity range with single pulse
- Seven precision optical measurement modes:
 - 3 proximity ranges
 - 3 dc ambient ranges
 - 1 calibration mode
- Low-noise ambient cancelling circuit allows maximum sensitivity with 8–12 bit resolution
- ALS works in direct sunlight (100 klux)
- Minimum reflectance sensitivity <math><1 \mu\text{W}/\text{cm}^2</math>
- High EMI immunity without shielded packaging
- Power supply: 2.2–3.7 V
- Operating temperature range: –40 to +85 °C
- Typical 10 μA current consumption
- Programmable 400/50 mA LED constant current driver output
- Allows independent LED supply voltage
- Small outline 3 x 3 mm (ODFN)

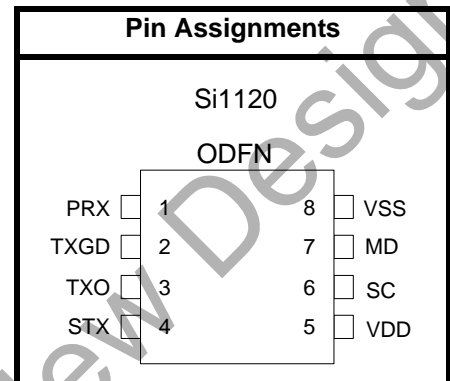

U.S. Patent #5,864,591

U.S. Patent #6,198,118

Other patents pending

Applications

- Handsets
- Touchless switches
- Occupancy sensors
- Consumer electronics
- Notebooks/PCs
- Industrial automation
- Display backlighting control
- Photo-interrupter

Description

The Si1120 is a low-power, reflectance-based proximity and ambient light sensor with advanced analog signal processing and analog PWM output. It includes an integrated differential photodiode, signal processor, and LED driver. Proximity sensing is based on the measurement of reflected light from an external, optically-isolated, strobed LED. A separate visible light photodiode is used for ambient light sensing. The standard package for the Si1120 is an 8-pin ODFN.

Si1120

Functional Block Diagram

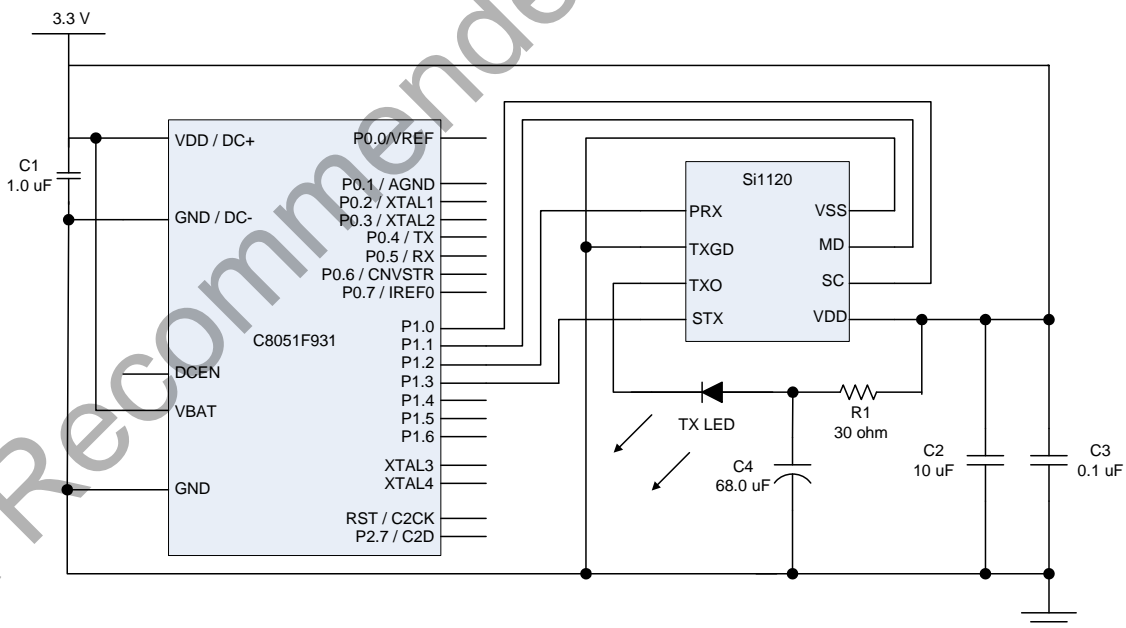
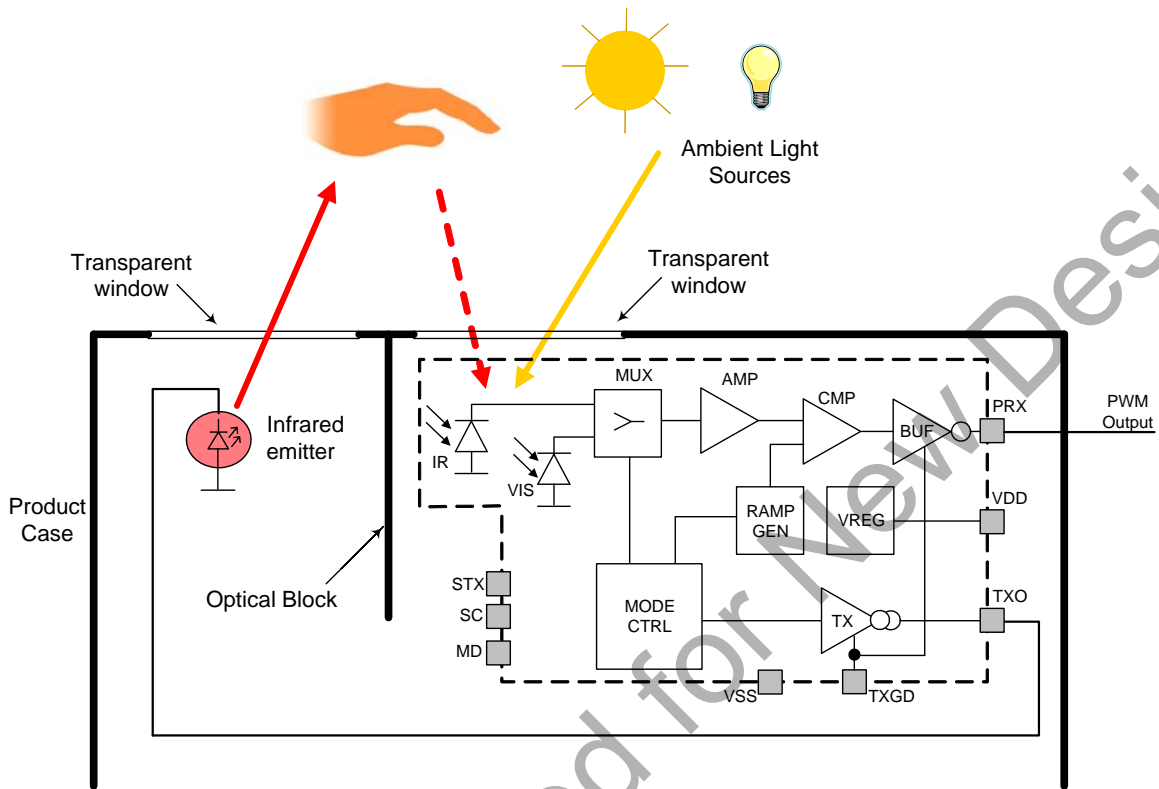

Figure 1. Si1120 Typical Application Example of Digital Proximity and Ambient Light Sensor with C8051F931 MCU and I²C Interface

TABLE OF CONTENTS

<u>Section</u>	<u>Page</u>
1. Electrical Specifications	4
2. Application Information	6
2.1. Theory of Operation	6
2.2. Mode Selection	7
2.3. Proximity Modes	8
2.4. Ambient-Light Modes	11
2.5. Choice of LED and LED Current	14
2.6. Power-Supply Transients	14
2.7. Practical Considerations	15
3. Pin Descriptions—Si1120 (ODFN)	16
4. Ordering Guide	17
5. Photodiode Centers	17
6. Package Outline (8-Pin ODFN)	18
Document Change List	19
Contact Information	20

1. Electrical Specifications

Table 1. Absolute Maximum Ratings*

Parameter	Conditions	Min	Typ	Max	Units
Supply Voltage		-0.3	—	5.5	V
Operating Temperature		-40	—	85	°C
Storage Temperature		-65	—	85	°C
Voltage on TXO with respect to GND		-0.3	—	5.5	V
Voltage on all other Pins with respect to GND		-0.3	—	VDD + 0.3	V
Maximum Total Current through TXO (TXO active)		—	—	500	mA
Maximum Total Current through TXGD and VSS		—	—	600	mA
Maximum Total Current through all other Pins		—	—	100	mA
ESD Rating	Human body model	—	—	2	kV

***Note:** Stresses above those listed in this table may cause permanent damage to the device. This is a stress rating only, and functional operation of the devices at those or any other conditions above those indicated in the operational listings of this specification is not implied. Exposure to maximum rating conditions for extended periods may affect device reliability.

Table 2. Recommended Operating Conditions

Parameter	Symbol	Conditions / Notes	Min	Typ	Max	Units
Typical Operating Conditions (T_A = 25 °C)						
Supply Voltage	V _{DD}	T = -40 to +85 °C, V _{DD} to GND, TXGD	2.2	3.3	3.7	V
Operating Temperature			-40	25	85	°C
SC/MD/STX High Threshold	V _{IH}		V _{DD} -0.7	—	—	V
SC/MD/STX Low Threshold	V _{IL}		—	—	0.6	V
Active TXO Voltage ¹			—	—	1.0	V
ALS Operating Range	E _{dc}		—	—	100	kLx
Proximity Conversion Frequency ²			—	125	250	Hz
LED Emission Wavelength ³			600	850	950	nm

Notes:

1. Minimum R1 resistance should be calculated based on LED forward voltage, maximum LED current, LED voltage rail used, and maximum active TXO voltage.
2. When in Mode 0 and operating at 250 Hz, STX pulse width should be limited to 1 ms.
3. When using LEDs near the min and max wavelength limits, higher radiant intensities may be needed to achieve the end system's proximity sensing performance goals.

Table 3. Electrical Characteristics

Parameter	Symbol	Conditions / Notes	Min	Typ	Max	Units
IDD Shutdown		SC >VIH, VDD = 2.7 to 3.7, T = 27 °C	—	0.1	1.0	μA
IDD Current Idle		SC = STX <VIL	—	90	150	μA
IDD Current During Transmit, Not Saturated		VDD = 3.3 V, LED I = 400 mA	—	14	—	mA
IDD Current During Transmit, Not Saturated		VDD = 3.3 V, LED I = 50 mA	—	3	—	mA
PRX Pulse Width Range	Tprx	VDD = 3.3 V	0.5	—	2500	us
PRX Logic High Level	VOH	I _{OH} = -4 mA	VDD-0.7	—	—	V
PRX Logic Low Level	VOL	I _{OL} = 4 mA	—	—	0.6	V
Min. Detectable Reflectance Input	Emin	VDD = 3.3 V (Mode 0,2)	—	1	—	μW/cm ²
Max. Detectable Reflectance Input	E _{max1}	VDD = 2.2 V (Mode 3)	—	12	—	mW/cm ²
Max. Detectable Reflectance Input	E _{max2}	VDD = 3.7 V (Mode 3)	—	48	—	mW/cm ²
Calibration Mode PRX Pulse Width	Tp _{wcal}	VDD = 3.3 V, Mode 1	—	7	—	us
TXO Leakage Current	Itxo_sd	VDD = 3.3 V, No strobe	—	0.01	1	μA
TXO Current (TX High Power)	Itxo	VDD = 3.3 V, TXO = 1 V (Mode 0)	—	400	—	mA
TXO Current (TX Low Power)	Itxo	VDD = 3.3 V, TXO = 1 V (Mode 2,3)	—	50	—	mA
Power Up Latency*		VDD = 3.3 V	—	—	535	μs
Full-Scale Ambient Light	FSals1	VDD = 3.3 V, Mode 5	—	500	—	Lx
Full-Scale Ambient Light	FSals2	VDD = 3.3 V, Mode 6	—	100	—	kLx
Full-Scale Ambient Light	FSals3	VDD = 3.3 V, Mode 7	—	10	—	kLx

*Note: Refer to "2.2. Mode Selection" on page 7 for additional information.

2. Application Information

2.1. Theory of Operation

The Si1120 is an active optical-reflectance proximity detector and ambient-light sensor with a pulse-width modulated output. Depending on the mode selected, the duration of the PRX active (low) state is proportional to the amount of reflected light, the amount of zero-reflectance offset, or the amount of ambient light. The detection rate can be set by adjusting the frequency of the STX signal.

The dual-port, active reflection proximity detector has significant advantages over single-port, motion-based infrared systems, which are good only for triggered events. Motion detection only identifies proximate moving objects and is ambiguous about stationary objects. The Si1120 allows in- or out-of-proximity detection, reliably determining if an object has left the proximity field or is still in the field even when it is not moving.

An example of a proximity detection application is controlling the display and speaker of a cellular telephone. In this type of application, the cell phone turns off the power-consuming display and disables the loudspeaker when the device is next to the ear, then reenables the display (and, optionally, the loudspeaker) when the phone moves more than a few inches away from the ear.

For small objects, the drop in reflectance is as much as the fourth power of the distance; this means that there is less range ambiguity than with passive motion-based devices. For example, a sixteen-fold change in an object's reflectance means only a fifty-percent drop in detection range. The Si1120 periodically measures proximity at a rate that can be set by an external controller.

The Si1120 modes are:

- PRX400 Proximity, 400 mA LED current
- PRX50 Proximity, 50 mA LED current
- PRX50H Proximity, 50 mA LED current, high reflectance range
- OFC Offset calibration (proximity mode, no LED current)
- VAMB Visible ambient (10 klux sunlight)
- VIRL Visible and infrared ambient light, low range (500 lux sunlight)
- VIRH Visible and infrared ambient light, high range (128 klux sunlight)

2.2. Mode Selection

The Si1120 features a shutdown mode, three proximity-detection modes, three ambient-light sensing modes, and an offset calibration for high-sensitivity mode. Mode selection is accomplished through the sequencing of the SC (shutdown/clock), MD (mode), and STX (strobe/transmit) pins.

The part enters shutdown mode unconditionally when SC is high. Each of the MD and STX inputs should be set to a valid high or low state. In shutdown mode, the PRX output is tri-stated, and the power-supply and TXO output leakage currents are negligible.

The active modes are set by clocking the state of MD and STX on the falling edge of SC and then setting MD to the required state. Since setting SC high forces shutdown, SC must be held low for the selected mode to remain active. The timing diagram in Figure 2 illustrates the programming sequence. Table 4 indicates the various mode encodings. After the correct state has been programmed, the STX input is used to trigger measurements.

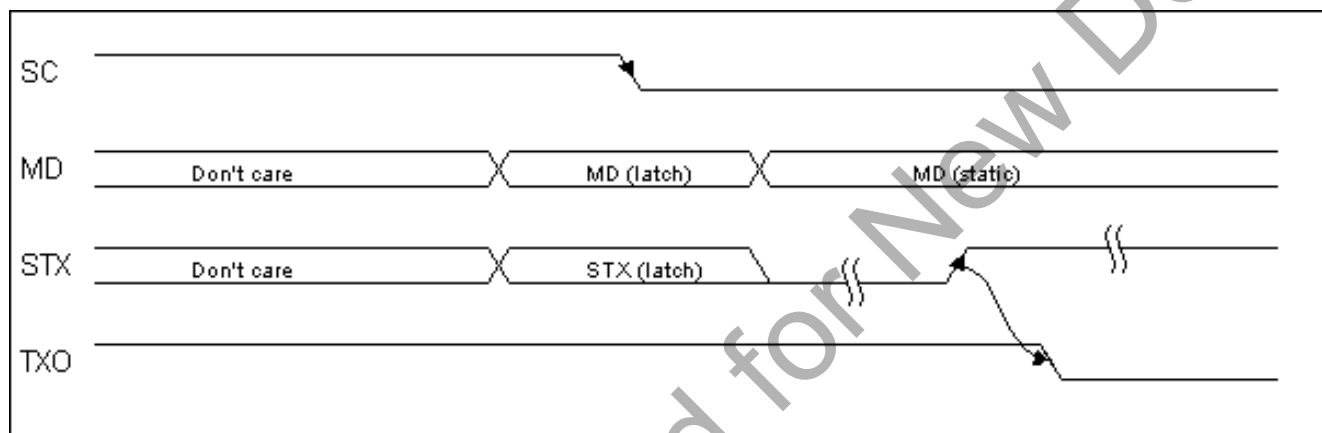

Figure 2. Si1120 Mode Programming Timing Diagram

Table 4. Mode Control Table

Mode	Description	STX (Latch)	MD (Latch)	MD (Static)
PRX400	Proximity, 400 mA LED current (Mode 0)	0	0	0
OFC	Offset calibration for high sensitivity (Mode 1)	0	0	1
PRX50	Proximity, 50 mA LED current (Mode 2)	0	1	0
PRX50H	Proximity, 50 mA LED current, high reflectance (Mode 3)	0	1	1
VIRL	Visible and infrared ambient, low range (Mode 4)	1	0	0
VAMB	Visible ambient (Mode 5)	1	0	1
VIRH	Visible and infrared ambient, high range (Mode 6)	1	1	0
(Reserved)	Reserved mode	1	1	1

If the mode must be changed, the SC pin may need to be rearmed (set high), in which case the shutdown mode is set and a power-on latency of about 500 μ s is incurred upon enabling of the selected mode when SC goes back low. Following a mode change, STX must be kept low during the power-up latency period. If the host sets STX too early, the Si1120 may not begin a measurement cycle; PRX does not assert. If this occurs, the host can restart a measurement by toggling STX.

2.3. Proximity Modes

In proximity mode, an LED sends light pulses that are reflected from the target to a photodiode and processed by the Si1120's analog circuitry. Light reflected from a proximate object is detected by the receiver, and the Si1120 converts the light signal into a pulse at the PRX output of a duration proportional to the amount of reflected light. The LED is turned off at the trailing (rising) edge of the PRX pulse. The detection cycle may be aborted before the end of the PRX pulse by bringing STX low. This allows the system designer to limit the maximum LED "on" time in applications where high reflectivity periods are not of interest, thus saving power and minimizing the LED duty cycle. Aborting the detection cycle at a set time also enables fast threshold comparison by sampling the state of the PRX output at the trailing (falling) edge of the STX input. An active (low) PRX output when STX falls means that an object is within the detection range. Forcing a shorter detection cycle also allows a faster proximity measurement rate thus allowing more samples to be averaged for an overall increase in the signal-to-noise ratio.

For long-range detection, PRX400 mode is selected. For short-range detection, PRX50 mode is selected. PRX50H mode is typically used in short-range, single-optical-port applications where the internal optical reflection level is high. The greater reflectance range combined with a lower LED power prevents internal reflections from saturating the receiver circuit.

The offset calibration mode works the same way as the other proximity modes but without turning on the LED. This allows precise measurement of the environment and Si1120 internal offsets without any LED light being reflected. The offset calibration mode also allows compensation of drifts due to supply and temperature changes.

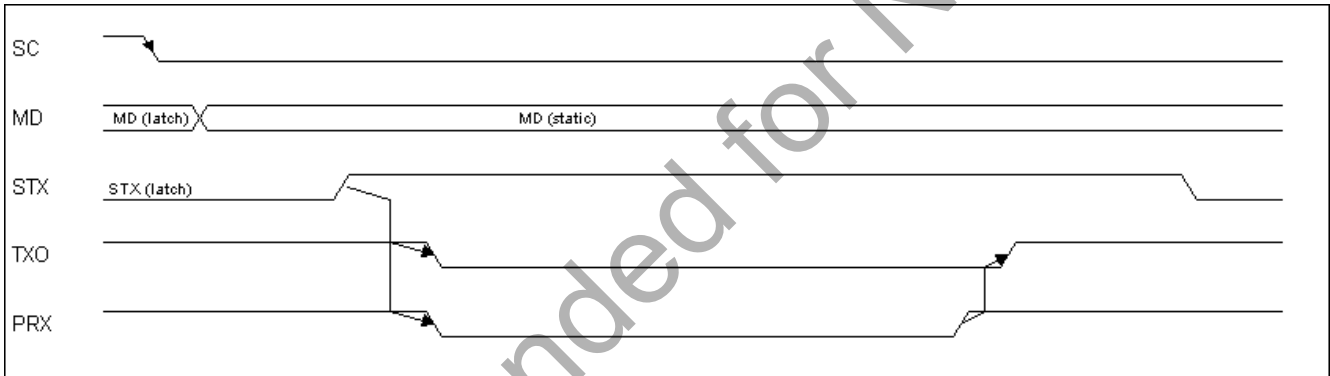

Figure 3. Proximity Mode Timing Diagram

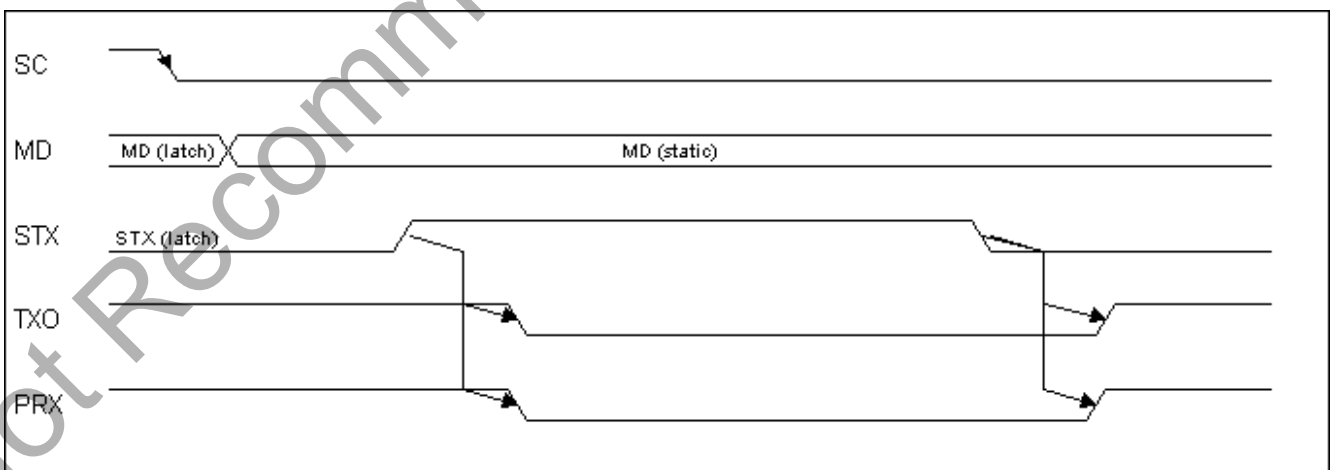

Figure 4. Proximity Mode Timing Diagram (Aborted Cycle)

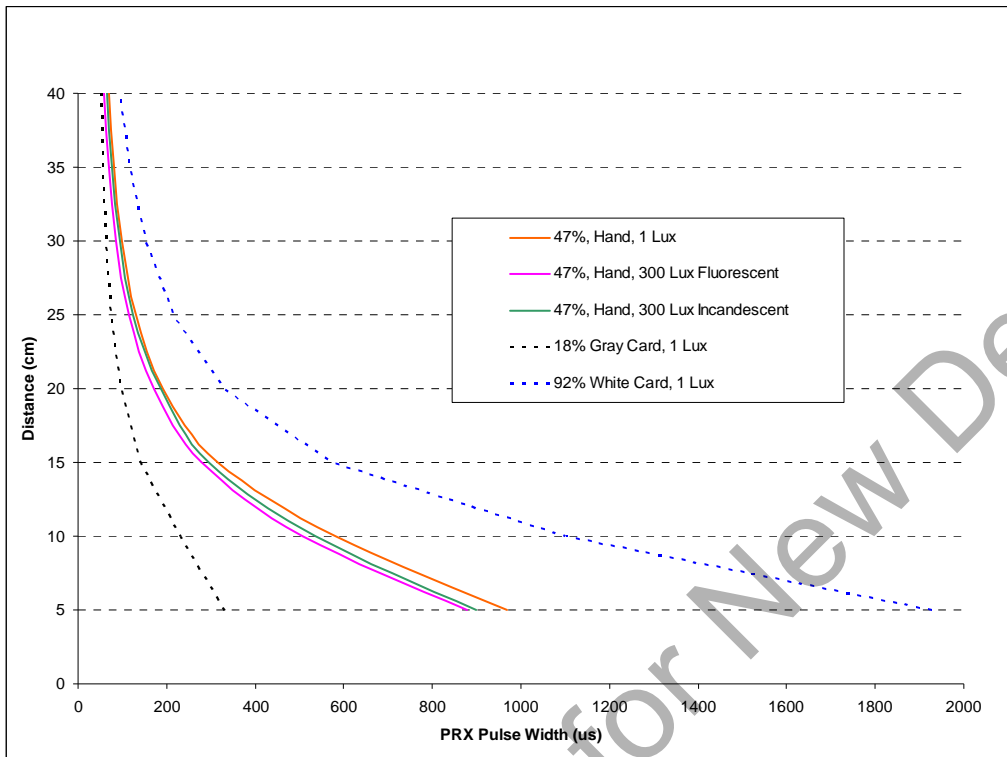

Figure 5. PRX400 Mode 0

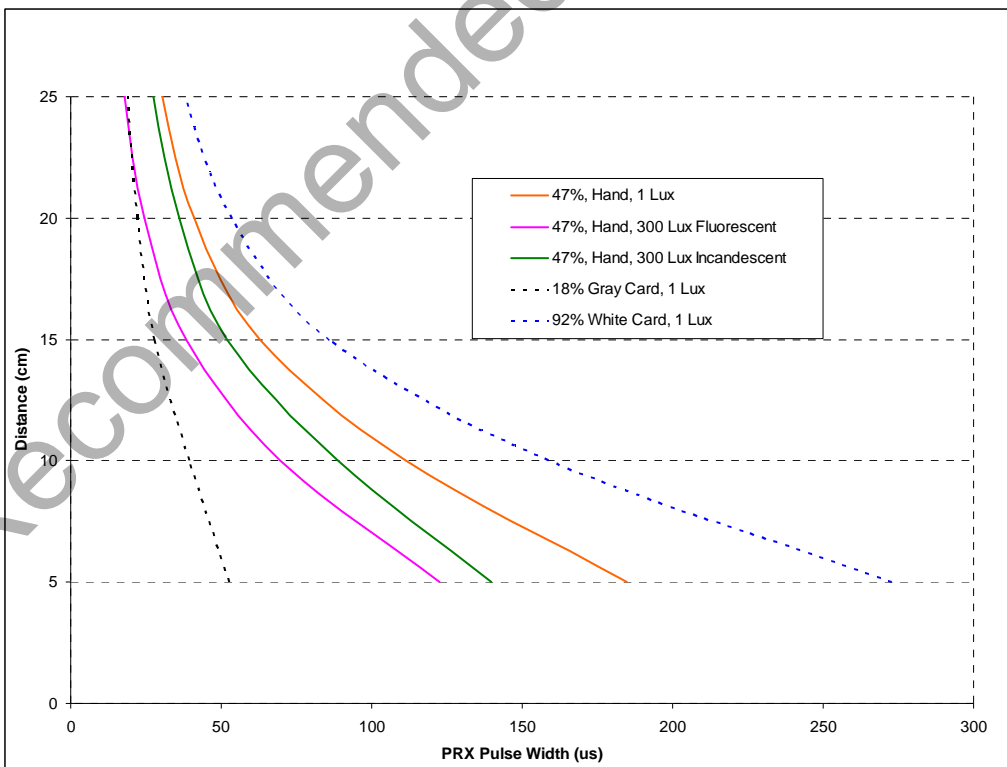

Figure 6. PRX50 Mode 2

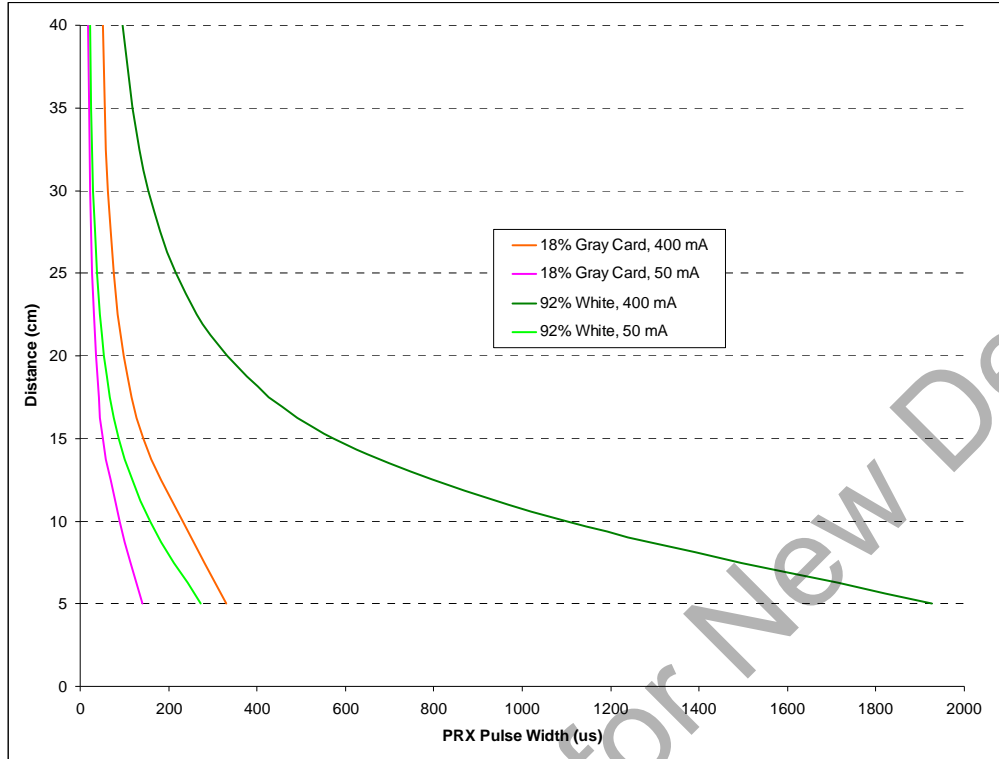

Figure 7. Combined PRX400 and PRX50

2.4. Ambient-Light Modes

Proximity offset and gain can be affected a few percent by high ambient light levels (e.g. sunlight or strong incandescent lighting). While the cal mode can be used to determine offsets from large ambient light or ambient noise levels in PRX400 and PRX50 modes, direct measurement of the ambient levels can help identify whether changes in reflectance are valid or in fact due to large ambient light changes. Usually, this is only an issue in high reflectance situations, such as single window operation without good optical isolation, where large changing ambients are an issue.

The Si1120 has two photodiodes, each of which peaks at a different wavelength. The VAMB mode uses the visible light photodiode which peaks at around 530 nm. On the other hand, the VIRH and VIRL modes use the photodiode which peaks at around 830 nm. Although the visible-light photodiode peaks near 550 nm (considered the peak wavelength of human perception), the Si1120 visible photodiode extends to infrared light as well. Similarly, the Si1120 infrared photodiode detects infrared light as well as part of the visible light spectrum. The Si1120 treats ultraviolet, visible, and infrared light as a continuous spectrum.

The ratio between the visible and infrared photodiode readings provides a good clue to the type of light source. The reason is that each light source consists of a characteristic mix of infrared and visible light. For example, blackbody radiators, such as incandescent or halogen lamps, can have significant energy in the infrared spectrum. On the other hand, fluorescent lamps have more energy in the visible light spectrum. The term “color ratio” will be used to describe the relative strength of the visible photodiode reading relative to the infrared photodiode reading. Human color vision employs a similar principle.

The VAMB/VIRH or VAMB/VIRL color ratios are representative of the Si1120's color perception. Choosing between these two color ratios depends on the light intensity. In general, VAMB/VIRL should be used first since VIRL has higher sensitivity. For higher light intensities, the VAMB/VIRH ratio should be used.

Note that VAMB, VIRH, and VIRL pulse widths are used as dividends and divisors in these ratios. What this means is that the pulse width offsets (at 0 lux) need to be removed prior to usage in the above color ratios. For best precision, it is best to take VAMB, VIRH, and VIRL measurements at 0 lux and to use actual measured values. However, a good rule of thumb is to subtract 7.1 μ s, 11.3 μ s, and 9.9 μ s respectively from VAMB, VIRH, and VIRL (then assigning 0 μ s to any resulting negative value). This rule-of-thumb can be used when accuracy is less critical. Unless stated otherwise, the plots and figures used in this data sheet use offset-corrected values for VAMB, VIRH, and VIRL.

Once a color ratio has been derived, the light type(s) and lux ratios are also identified. The lux ratio describes the ratio between the desired lux value and VAMB, VIRL, or VIRH (depending on the situation). The appropriate lux ratio, when multiplied with the applicable measurement, yields the final calculated lux value. Without any calibration, it should be possible to arrive within 50% (or 50 lux) of the absolute lux value.

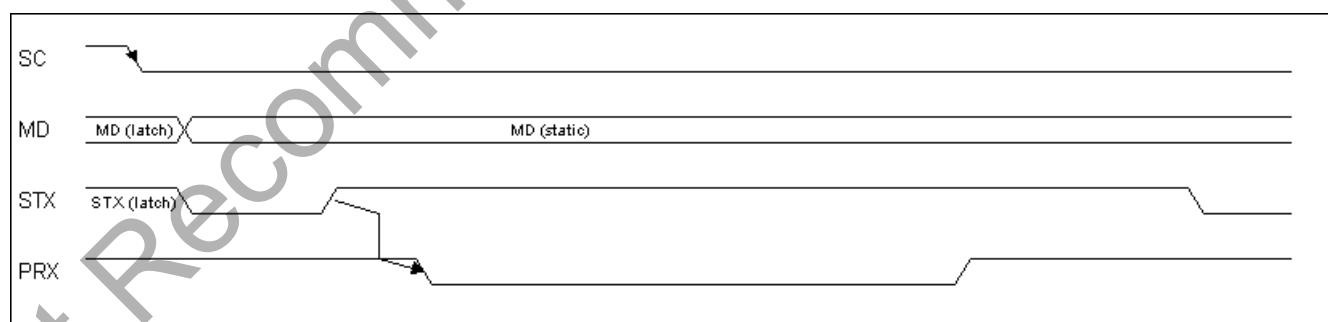

Figure 8. Ambient Light Mode Timing Diagram

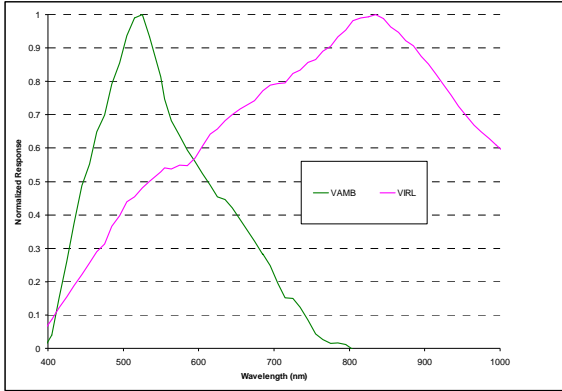

Figure 9. Si1120 Typical Spectral Response

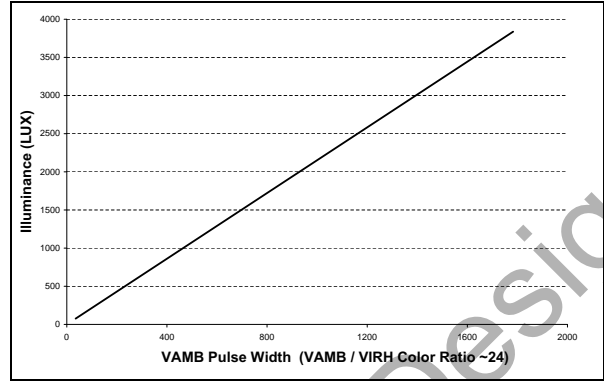

Figure 12. Incandescent/Halogen Transfer Function

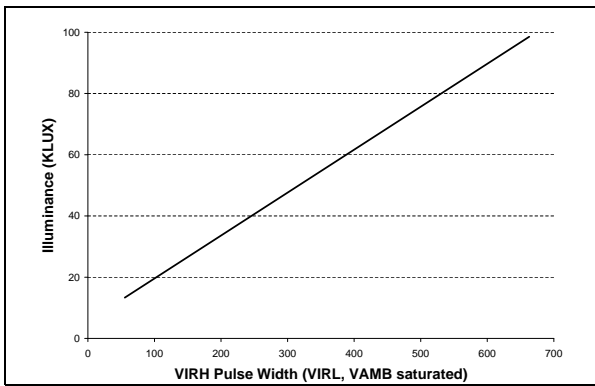

Figure 10. Sunlight Transfer Function

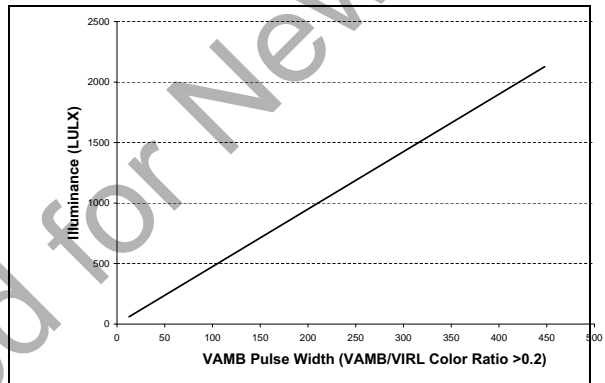

Figure 13. CFL Transfer Function

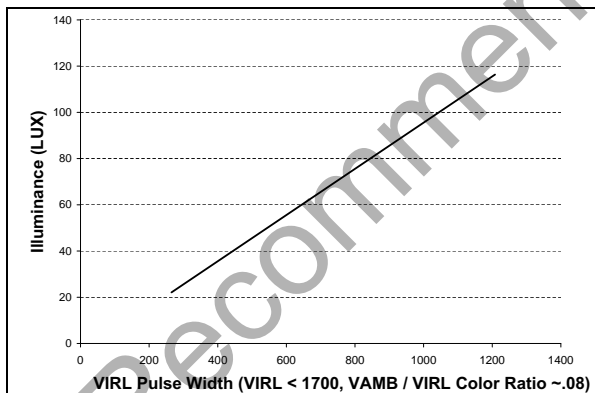

Figure 11. Low Light Transfer Function

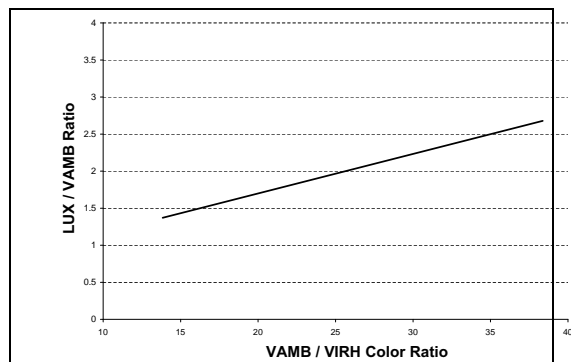

Figure 14. Lux/VAMB vs. Color Ratio

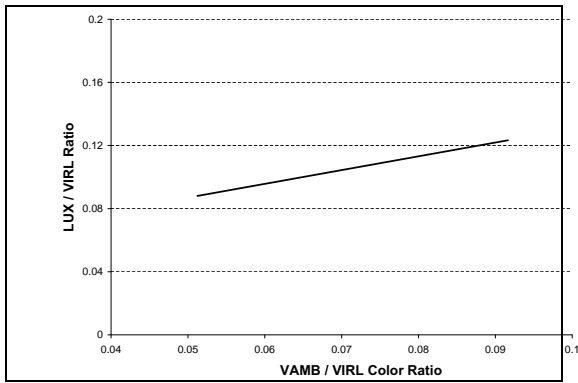

Figure 15. Lux/VIRL Ratio vs. Color Ratio

Not Recommended for New Designs

2.5. Choice of LED and LED Current

In order to maximize detection distance, the use of an infrared LED is recommended. However, red (visible) LEDs are viable in applications where a visible flashing LED may be useful and a shorter detection range is acceptable. Red LEDs do not permit the use of infrared filters and thus are more susceptible to ambient-light noise. This added susceptibility effectively reduces the detection range. White LEDs have slow response and do not match the Si1120's spectral response well; they are, therefore, not recommended.

The Si1120 maintains excellent sensitivity in high ambient and optically noisy environments, most notably from fluorescent lights. In very noisy environments, the maximum sensitivity may drop by a factor of up to one hundred, causing a significant reduction in proximity range. With reduced sensitivity, the effect of optical environmental noise is reduced. For this reason, it is best to drive the LED with the maximum amount of current available, and an efficient LED should be selected. With careful system design, the duty cycle can be made very low, thus enabling most LEDs to handle the peak current of 400 mA while keeping the LED's average current draw on the order of a few microamperes. Total current consumption can be kept well below that of a typical lithium battery's self-discharge current of 10 μ A, thus ensuring the battery's typical life of 10 years.

Another consideration when choosing an LED is the LED's half-angle. An LED with a narrow half-angle focuses the available infrared light using a narrower beam. When the concentrated infrared light encounters an object, the reflection is much brighter. Detection of human-size objects one meter away can be achieved when choosing an LED with a narrower half-angle and coupling it with an infrared filter on the enclosure.

2.6. Power-Supply Transients

2.6.1. V_{DD} Supply

The Si1120 has good immunity from power-supply ripple, which should be kept below 50 mVpp for optimum performance. Power-supply transients (at the given amplitude, frequency, and phase) can cause either spurious detections or a reduction in sensitivity if they occur at any time within the 300 μ s prior to the LED being turned on. Supply transients occurring after the LED has been turned off have no effect since the proximity state is latched until the next cycle. The Si1120 itself produces sharp current transients, and, for this reason, must also have a bulk capacitor on its supply pins. Current transients at the Si1120 supply can be up to 20 mA.

2.6.2. LED Supply

If the LED is powered directly from a battery or limited-current source, it is desirable to minimize the load peak current by adding a resistor in series with the LED's supply capacitor. If a regulated supply is available, the Si1120 should be connected to the regulator's output and the LED to the unregulated voltage, provided it is less than 6 V. There is no power-sequencing requirement between V_{DD} and the LED supply. The typical LED current peak of 400 mA can induce supply transients well over 50 mVpp, but those transients are easy to decouple with a simple R-C filter because the duty-cycle-averaged LED current is quite low.

2.6.3. LED Supply (Single Port Configuration)

When using a single optical port, the Si1120 attempts to detect changes in reflection that can be less than one percent of the received signal. A constant LED current is essential to avoid spurious detections. It is, therefore, critical to prevent TXO saturation. If TXO is allowed to saturate in a single-port configuration, the Si1120 will be very sensitive to LED power-supply variations and even to frequency variations at the STX input. A reservoir capacitor should be chosen based on the expected TXO pulse width, and a series resistor should be selected based on the STX duty cycle.

2.6.4. LED Supply (Dual Port Configuration)

When using separate optical ports for the LED and for the Si1120, the signal reflected from the target is large compared with the internal reflection. This eliminates the need for keeping the LED current constant, and the TXO output can, therefore, be allowed to saturate without problem. In addition, only the first 10 μ s of the LED turn-on time are critical to the detection range. This further reduces the need for large reservoir capacitors for the LED supply. In most applications, a 10 μ F capacitor is adequate. A 100 Ω to 1 k Ω resistor should be added in series to minimize peak load current.

2.7. Practical Considerations

It is important to have an optical barrier between the LED and the Si1120. The reflection from objects to be detected can be very weak since, for small objects within the LED's emission angle, the amplitude of the reflected signal decreases in proportion with the fourth power of the distance. The receiver can detect a signal with an irradiance of $1 \mu\text{W}/\text{cm}^2$. An efficient LED typically can drive to a radiant intensity of $100 \text{ mW}/\text{sr}$. Hypothetically, if this LED were to couple its light directly into the receiver, the receiver would be unable to detect any $1 \mu\text{W}/\text{cm}^2$ signal since the $100 \text{ mW}/\text{cm}^2$ leakage would saturate the receiver. Therefore, to detect the $1 \mu\text{W}/\text{cm}^2$ signal, the internal optical coupling (e.g. internal reflection) from the LED to the receiver must be minimized to the same order of magnitude (decrease by 10^5) as the signal the receiver is attempting to detect. As it is also possible for some LEDs to drive a radiant intensity of $400 \text{ mW}/\text{sr}$, it is good practice to optically decouple the LED from the source by a factor of 10^6 . A Dual-Port Optical Window shown in Figure 16 can accomplish this easily.

If an existing enclosure is being reused and does not have dedicated openings for the LED and the Si1120, the proximity detector may still work if the optical loss factor through improvised windows (e.g. nearby microphone or fan holes) or semi-opaque material is not more than 90% in each direction. In addition, the internal reflection from an encased device's PMMA (acrylic glass) window (common in cellular telephones, PDAs, etc.) must be reduced through careful component placement. To reduce the optical coupling from the LED to the Si1120 receiver, the distance between the LED and the Si1120 should be maximized, and the distance between both components (LED and Si1120) to the PMMA window should be minimized. The PRX50H mode can be used for the Single-Port Optical Window shown in Figure 16.

Another practical consideration is that system optical leakage, overlay thickness and transmittance, LED efficiency variation, TXO sink drive and photodiode part-to-part difference all collectively lead to reflectance measurement variation even under a given proximity condition. For applications requiring PRX pulse width consistency across multiple systems, factory calibration is recommended. Factory calibration involves taking a reference measurement against a consistent and reproducible reflective object (such as an 18% gray card) at a fixed distance during system production testing. Having this reference proximity measurement stored in non-volatile RAM or Flash allows host software to make necessary adjustments to incoming PRX pulse widths against this reference proximity measurement. A low background infrared environment is recommended.

For best proximity range performance, the system optical leakage can be characterized during factory calibration. To do this, a reference proximity measurement is made when it is known that no object is in proximity of the system at the time of the measurement. The 'no object' reference measurement allows host software to establish the level of system optical leakage and make the necessary corrections to account for this.

In a similar way, for applications with heavy reliance on ALS accuracy, measurements using reference light sources during factory calibration can be used to make adjustments to VAMB, VIRL, and VIRH measurements.

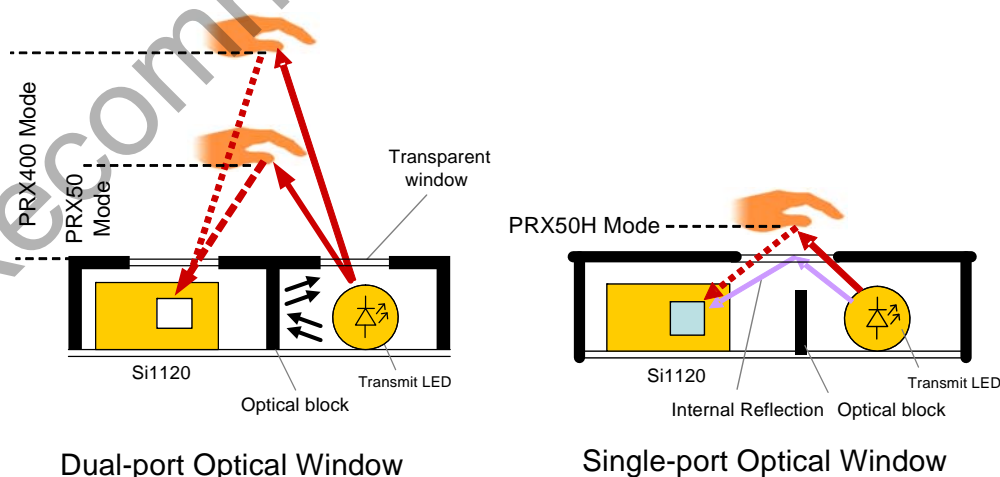

Figure 16. Dual-Port and Single-Port Optical Window

3. Pin Descriptions—Si1120 (ODFN)

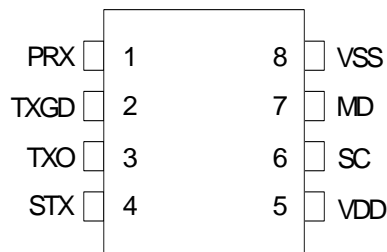

Figure 17. Pin Configurations

Table 5. Pin Descriptions

Pin	Name	Description
1	PRX	PWM Output. Outputs a low-going PWM pulse proportional to signal.
2	TXGD	TXGD. Power ground (LED and PRX driver ground return). Must be connected to VSS.
3	TXO	Transmit Output. Normally connected to an infrared LED cathode. The output current is a programmable constant current sink. This output can be allowed to saturate, and output current can be limited by the addition of a resistor in series with the LED.
4	STX	Strobe. Initiates PS or ALS measurement. Also used as data input for the M2 internal mode control flip-flop.
5	V _{DD}	Power Supply. 2.2 to 3.7 V voltage source.
6	SC	Shutdown/Clock. When high, shuts down the part. When enabling the part, the low-going edge clocks the states of STX and MD into mode-control D flip-flops M2 and M3.
7	MD	Mode Control. Controls two mode control bits, one directly and the other indirectly, by providing the data input for the M3 internal mode control flip-flop.
8	VSS	VSS. Ground (analog ground). Must be connected to TXGD.

4. Ordering Guide

Part Ordering #	Temperature	Package
Si1120-A-GM	-40 to +85 °C	3x3 mm ODFN8

5. Photodiode Centers

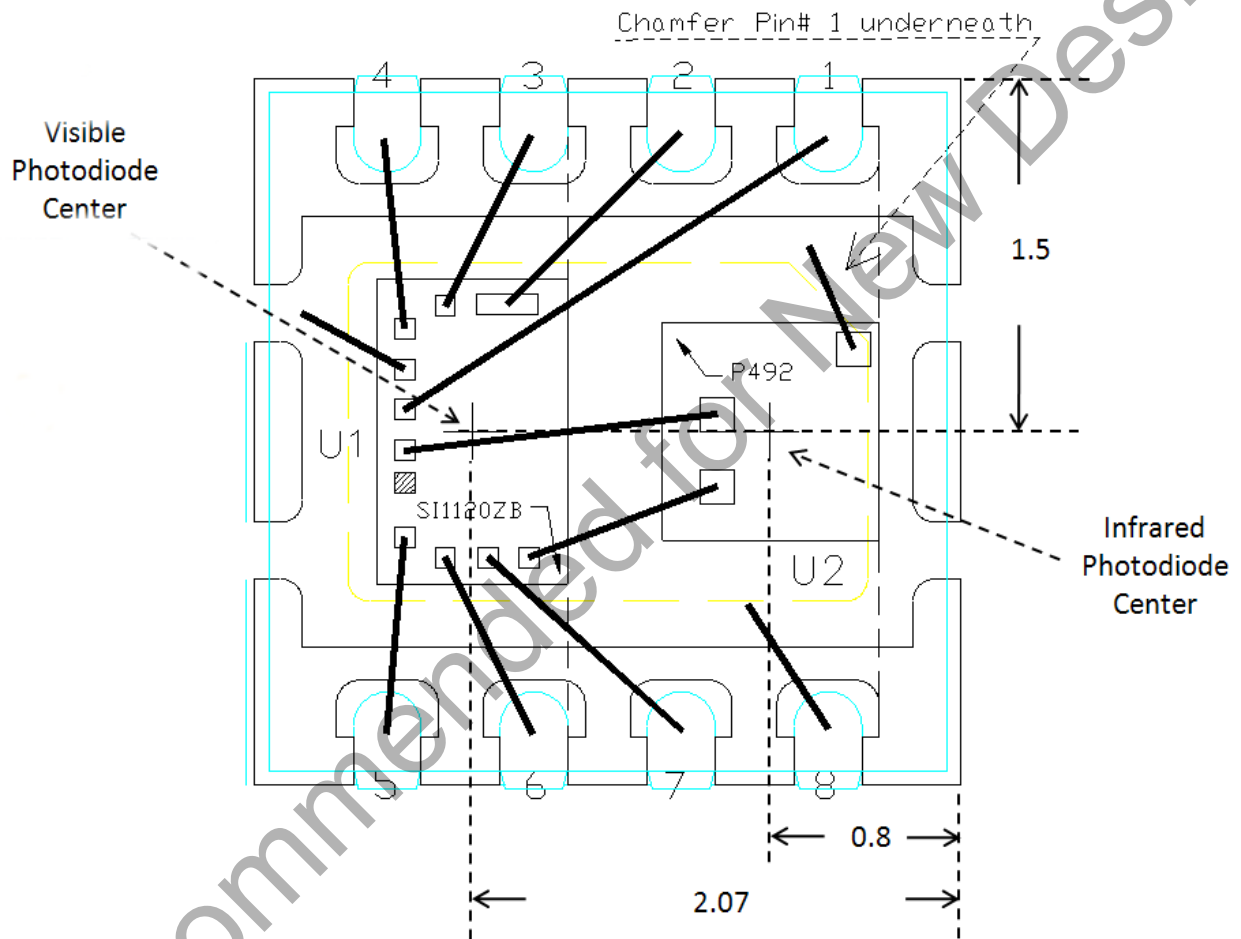

6. Package Outline (8-Pin ODFN)

Figure 18 illustrates the package details for the Si1120 ODFN package. Table 6 lists the values for the dimensions shown in the illustration.

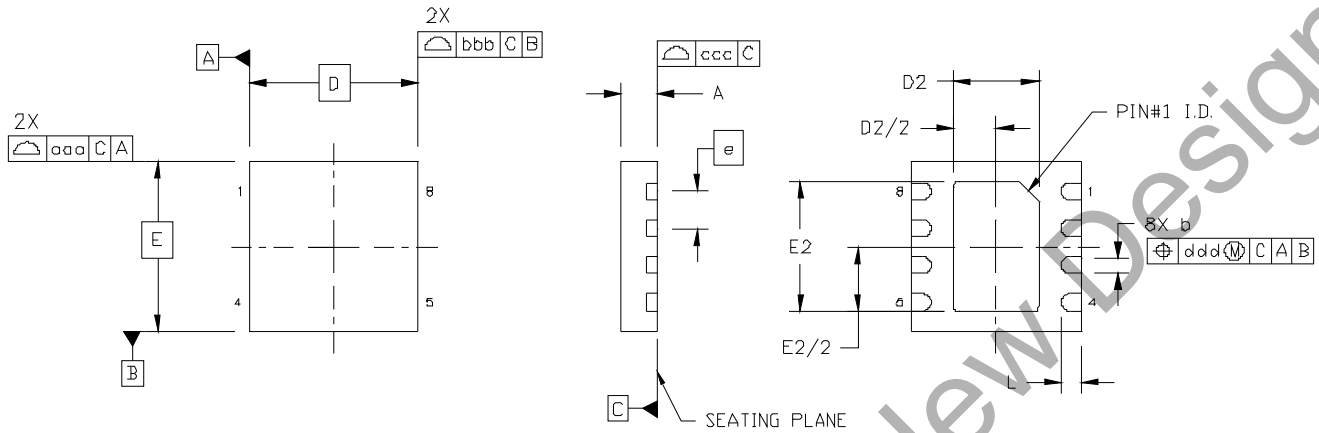

Figure 18. ODFN Package Diagram Dimensions

Table 6. Package Diagram Dimensions

Dimension	Min	Nom	Max
A	0.55	0.65	0.75
b	0.25	0.30	0.35
D	3.00 BSC.		
D2	1.40	1.50	1.60
e	0.65 BSC.		
E	3.00 BSC.		
E2	2.20	2.30	2.40
L	0.30	0.35	0.40
aaa	0.10		
bbb	0.10		
ccc	0.08		
ddd	0.10		
Notes:			
1. All dimensions shown are in millimeters (mm).			
2. Dimensioning and Tolerancing per ANSI Y14.5M-1994.			

DOCUMENT CHANGE LIST

Revision 0.41 to Revision 0.42

- Removed custom package option.
- Updated Table 1 on page 4.
 - Added Operating, Storage temps, and ESD to Table 1.
- Updated "4. Ordering Guide" on page 17.
 - Added ordering part number information.
- Added "6. Package Outline (8-Pin ODFN)" on page 18.
- Updated " Functional Block Diagram" on page 2.
- Added Figures 5, 6, and 7.
- Updated "2.4. Ambient-Light Modes" on page 11.
- Added Figures 9, 10, 11,12, 13, 14, and 15.
- Updated "2.5. Choice of LED and LED Current" on page 14.

Revision 0.42 to Revision 0.43

- Updated Table 3 on page 5.
 - Updated power up latency maximum value from 300 to 500 μ s.
 - Updated FSals2 typical value from 128 to 100.
- Updated "2.2. Mode Selection" on page 7.

Revision 0.43 to Revision 1.0

- Updated Table 3 on page 5.
 - Widened limits of PRX Pulse Width Range from 4 min / 2200 max to 0.5 min / 2500 max.
 - PRX Logic High Level changed to $VDD - 0.7$ from $VDD - 0.5$.
 - Removed IDD current specification for saturated driver condition.
 - Removed Temperature Coefficient specification.
 - Increased power-up latency from 500 to 535 μ s.
 - Changed IDD Current Idle from 120 μ A TYP to 90 μ A TYP and 300 μ A Max to 150 μ A Max.
- Updated first paragraph in "2.4. Ambient-Light Modes" on page 11.
- Renamed Section "2.7. Mechanical and Optical Implementation" to "2.7. Practical Considerations" .
 - Added factory calibration guidance.
- Added "5. Photodiode Centers" on page 17.

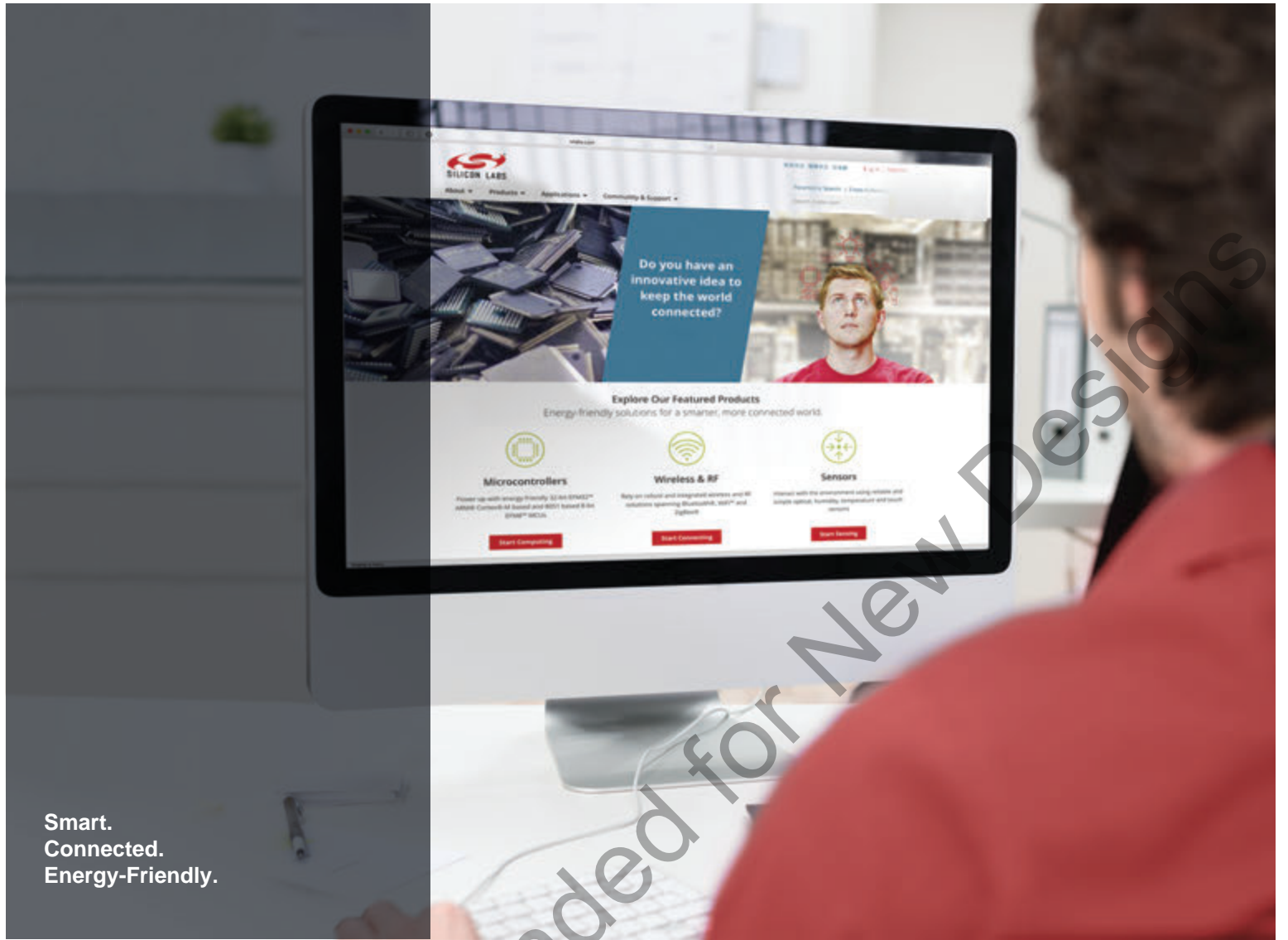

Smart.
Connected.
Energy-Friendly.



Products
www.silabs.com/products



Quality
www.silabs.com/quality



Support and Community
community.silabs.com

Disclaimer

Silicon Laboratories intends to provide customers with the latest, accurate, and in-depth documentation of all peripherals and modules available for system and software implementers using or intending to use the Silicon Laboratories products. Characterization data, available modules and peripherals, memory sizes and memory addresses refer to each specific device, and "Typical" parameters provided can and do vary in different applications. Application examples described herein are for illustrative purposes only. Silicon Laboratories reserves the right to make changes without further notice and limitation to product information, specifications, and descriptions herein, and does not give warranties as to the accuracy or completeness of the included information. Silicon Laboratories shall have no liability for the consequences of use of the information supplied herein. This document does not imply or express copyright licenses granted hereunder to design or fabricate any integrated circuits. The products are not designed or authorized to be used within any Life Support System without the specific written consent of Silicon Laboratories. A "Life Support System" is any product or system intended to support or sustain life and/or health, which, if it fails, can be reasonably expected to result in significant personal injury or death. Silicon Laboratories products are not designed or authorized for military applications. Silicon Laboratories products shall under no circumstances be used in weapons of mass destruction including (but not limited to) nuclear, biological or chemical weapons, or missiles capable of delivering such weapons.

Trademark Information

Silicon Laboratories Inc.®, Silicon Laboratories®, Silicon Labs®, SiLabs® and the Silicon Labs logo®, Bluegiga®, Bluegiga Logo®, Clockbuilder®, CMEMS®, DSPLL®, EFM®, EFM32®, EFR®, Ember®, Energy Micro, Energy Micro logo and combinations thereof, "the world's most energy friendly microcontrollers", Ember®, EZLink®, EZRadio®, EZRadioPRO®, Gecko®, ISOmodem®, Precision32®, ProSLIC®, Simplicity Studio®, SiPHY®, Telegesis, the Telegesis Logo®, USBXpress® and others are trademarks or registered trademarks of Silicon Laboratories Inc. ARM, CORTEX, Cortex-M3 and THUMB are trademarks or registered trademarks of ARM Holdings. Keil is a registered trademark of ARM Limited. All other products or brand names mentioned herein are trademarks of their respective holders.



Silicon Laboratories Inc.
400 West Cesar Chavez
Austin, TX 78701
USA

<http://www.silabs.com>

X-ON Electronics

Largest Supplier of Electrical and Electronic Components

Click to view similar products for [Optical Sensor Development Tools](#) category:

Click to view products by [Silicon Labs](#) manufacturer:

Other Similar products are found below :

[MT9V034C12STCH-GEVB](#) [MT9V115EBKSTCH-GEVB](#) [416015300-3](#) [ISL29102IROZ-EVALZ](#) [MT9M021IA3XTMH-GEVB](#)
[AR1820HSSC12SHQAH3-GEVB](#) [AR1335CSSC11SMKAH3-GEVB](#) [MAXCAMOV10640#](#) [MT9M031I12STMH-GEVB](#) [TSL2581CS-DB](#)
[TMD3700-DB](#) [NANOUSB2.2](#) [ASX340AT3C00XPEDH3-GEVB](#) [AR0144ATSM20XUEAH3-GEVB](#) [AR0144CSSC00SUKAH3-GEVB](#)
[AR0522SRSC09SURAH3-GEVB](#) [AR0522SRSM09SURAH3-GEVB](#) [AR0521SR2C09SURAH3-GEVB](#) [MARS1-MAX9295A-GEVK](#)
[MARS1-MAX9296B-GEVB](#) [ISL29112IROZ-EVALZ](#) [AR0233AT2C17XUEAH3-GEVB](#) [AR0431CSSC14SMRAH3-GEVB](#) [MARS-DEMO3-](#)
[MIPI-GEVB](#) [TCS3430-DB](#) [AR0234CSSC00SUKAH3-GEVB](#) [AR0130CSSM00SPCAH-GEVB](#) [AR0330CM1C00SHAAH3-GEVB](#) [EVALZ-](#)
[ADPD2212](#) [TMD2772EVM](#) [TMG3993EVM](#) [MIKROE-2103](#) [TSL2672EVM](#) [1384](#) [MT9M114EBLSTCZDH-GEVB](#) [SEN0043](#) [SEN0162](#)
[TMD2771EVM](#) [TMD3782EVM](#) [TSL4531EVM](#) [1918](#) [AS7225](#) [DEMO KIT](#) [SEN0097](#) [SEN0212](#) [SEN0228](#) [AR0134CSSC00SUEAH3-GEVB](#)
[AP0100AT2L00XUGAH3-GEVB](#) [AR0144CSSM20SUKAH3-GEVB](#) [725-28915](#) [EVAL-ADPD1081Z-PPG](#)