

---

## NON-ISOLATED EVALUATION BOARD FOR THE Si3402B

---

### 1. Description

The Si3402B non-isolated evaluation board (Si3402B-EVB Rev 2) is a reference design for a power supply in a Power over Ethernet (PoE) Powered Device (PD) application. The Si3402B is described more completely in the data sheet and application notes. This document describes the evaluation board. An evaluation board demonstrating the isolated application is described in the Si3402B-ISO-EVB user's guide.

### 2. Si3402B Board Interface

Ethernet data and power are applied to the board through the RJ45 connector (J1). The board itself has no Ethernet data transmission functionality, but, as a convenience, the Ethernet transformer secondary is brought out to the test points. Power may be applied in the following ways:

- Connecting a dc source to pins 1, 2 and 3, 6 of the Ethernet cable (either polarity)
- Connecting a dc source to pins 4, 5 and 7, 8 of the Ethernet cable (either polarity)
- Using an IEEE 802.3-2015-compliant, PoE-capable PSE, such as Trendnet TPE-1020WS

The Si3402B-EVB board schematics and layout are shown in Figures 1 through 6. The dc output is at connectors J11(+) and J12(-).

Boards are generally shipped configured to produce +5 V output voltage but can be configured for +3.3 V or other output voltages by changing resistors R5 and R6. Refer to "AN956: Using the Si3402B PoE PD Controller in Isolated and Non-Isolated Designs" for more information. The preconfigured Class 3 signature can also be modified according to Table 3 in AN956. The D8–D15 Schottky type diode bridge bypass is recommended only for higher power levels (Class 3 operation). For lower power levels, such as Class 1 and Class 2, the diodes can be removed. When the Si3402B is used in external diode bridge configuration, it requires that at least one pair of the CTx and SPx pins be connected to the PoE voltage input terminals (to the input of the external bridge).

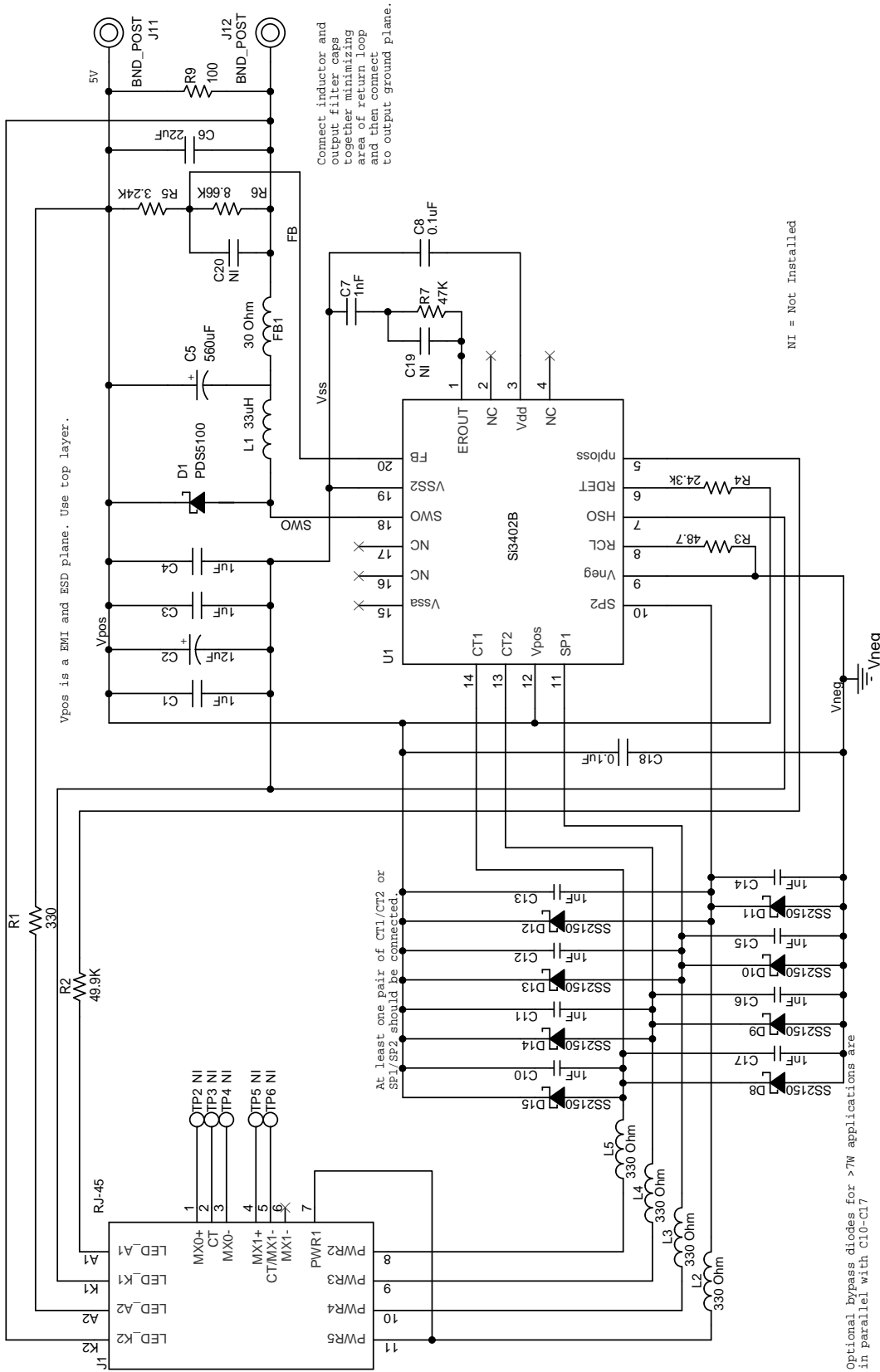

Connect inductor and output filter caps together minimizing area of return loop and then connect to output ground plane.

Vpos is a thermal plane as well as ESD and EMI. Use thermal vias to at least 1 inch square plane on backside 1 to 1.2mm pitch 0.3 to 0.33mm diameter.

Optional bypass diodes for >7W applications are in parallel with C10-C17

NI = Not Installed

**Figure 1. Si3402B Schematic—5 V, Class 3 PD**

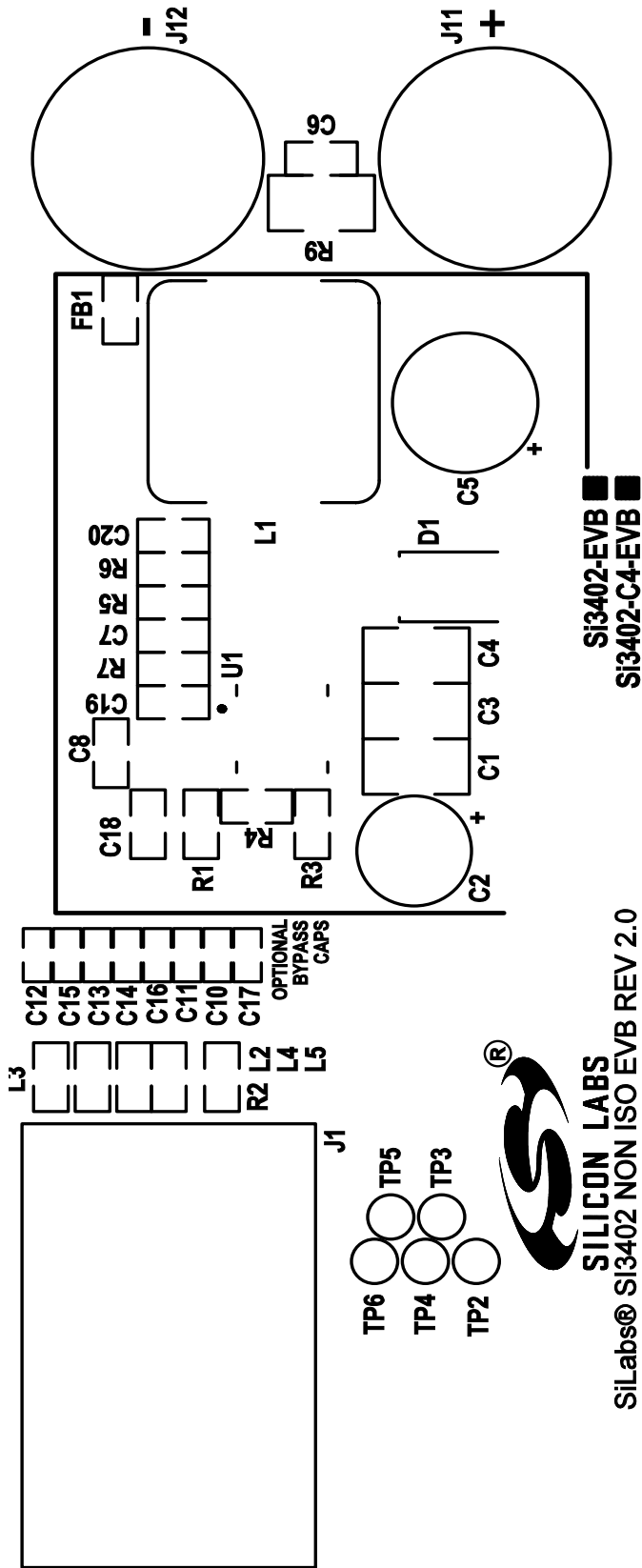

SiLabs® SI3402 NON ISO EVB REV 2.0



SILICON LABS

Figure 2. Top Silkscreen

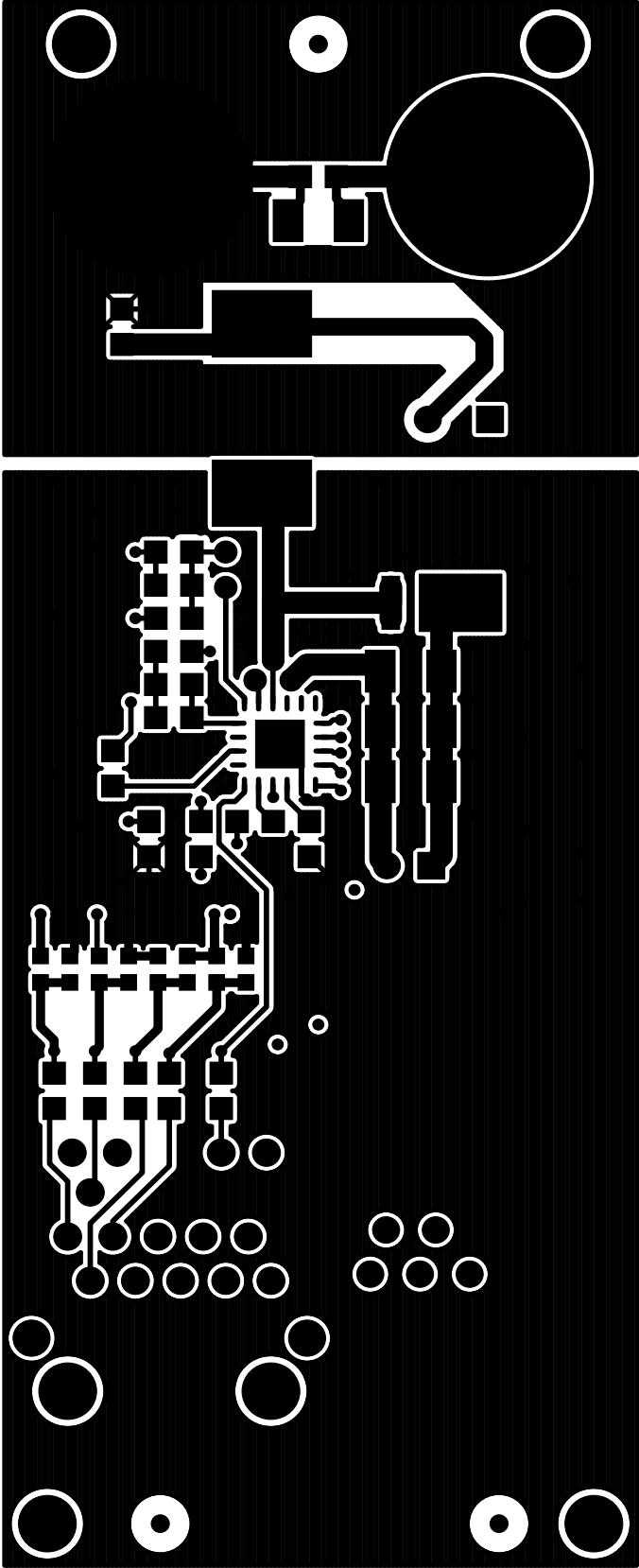

Figure 3. Top Layer

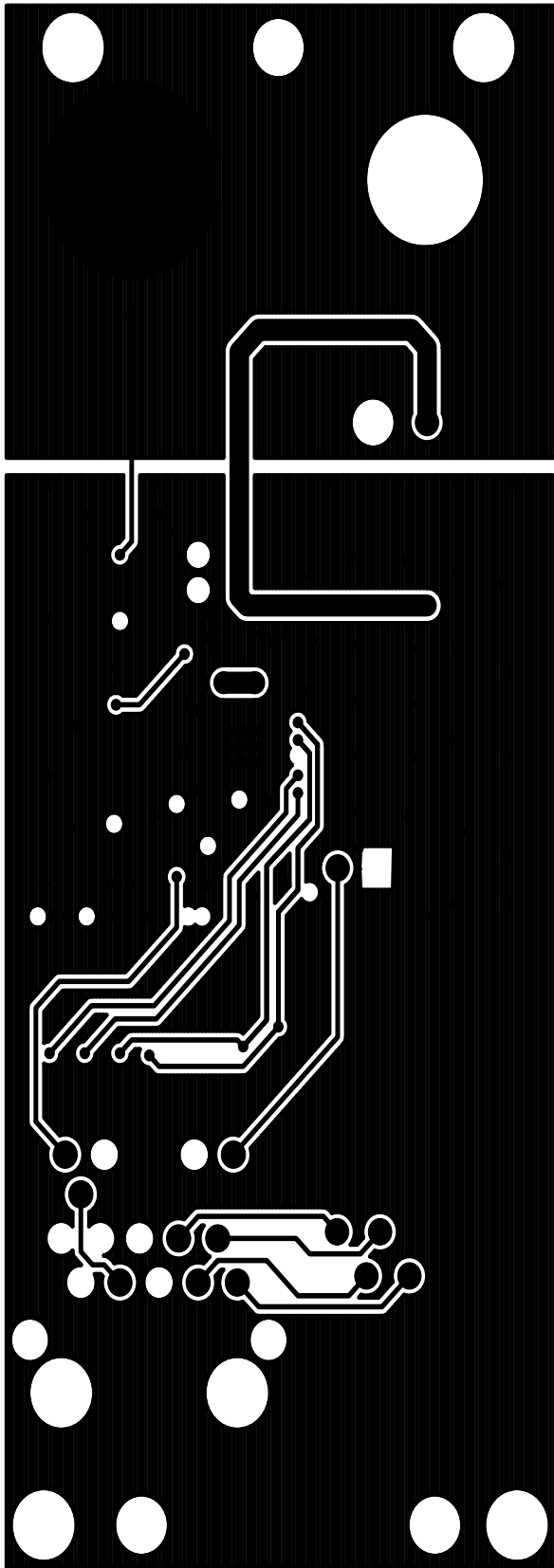

Figure 4. Internal 1 (Layer 2)

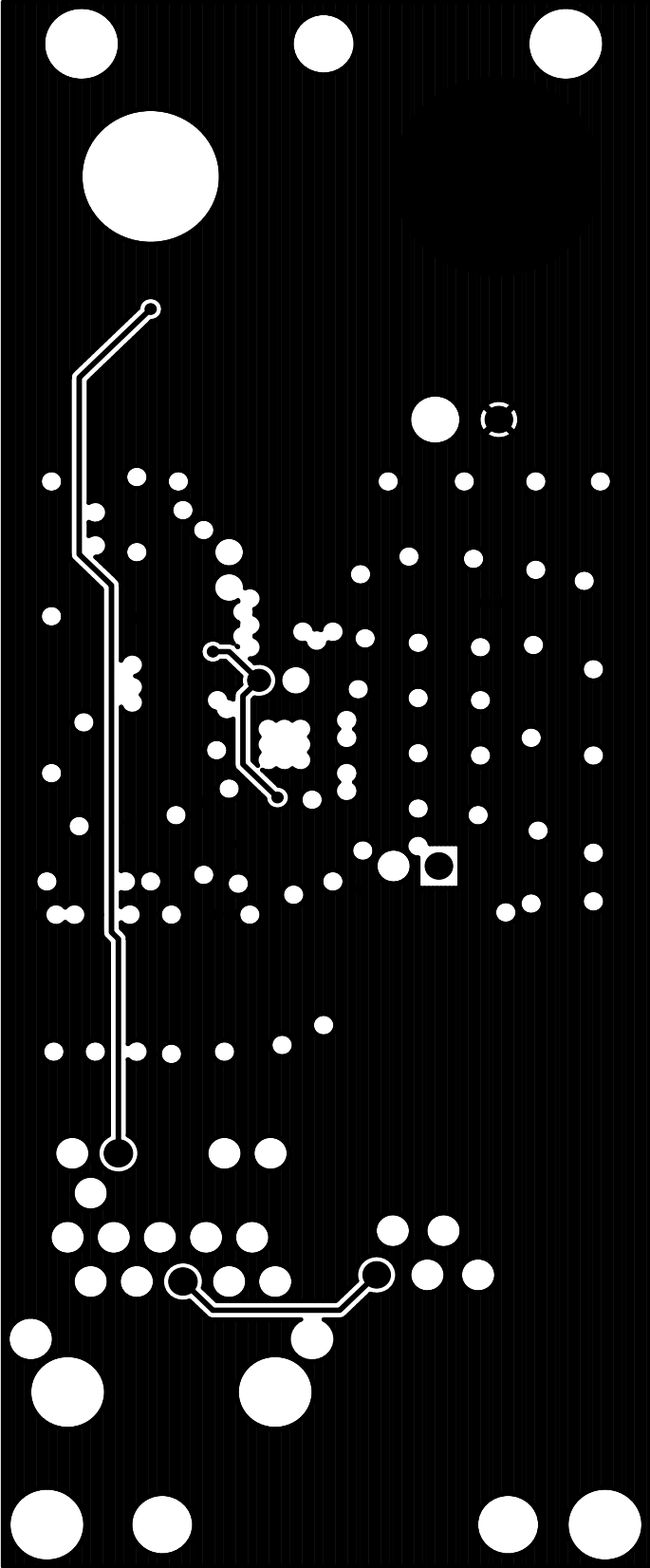

Figure 5. Internal 2 (Layer 3)

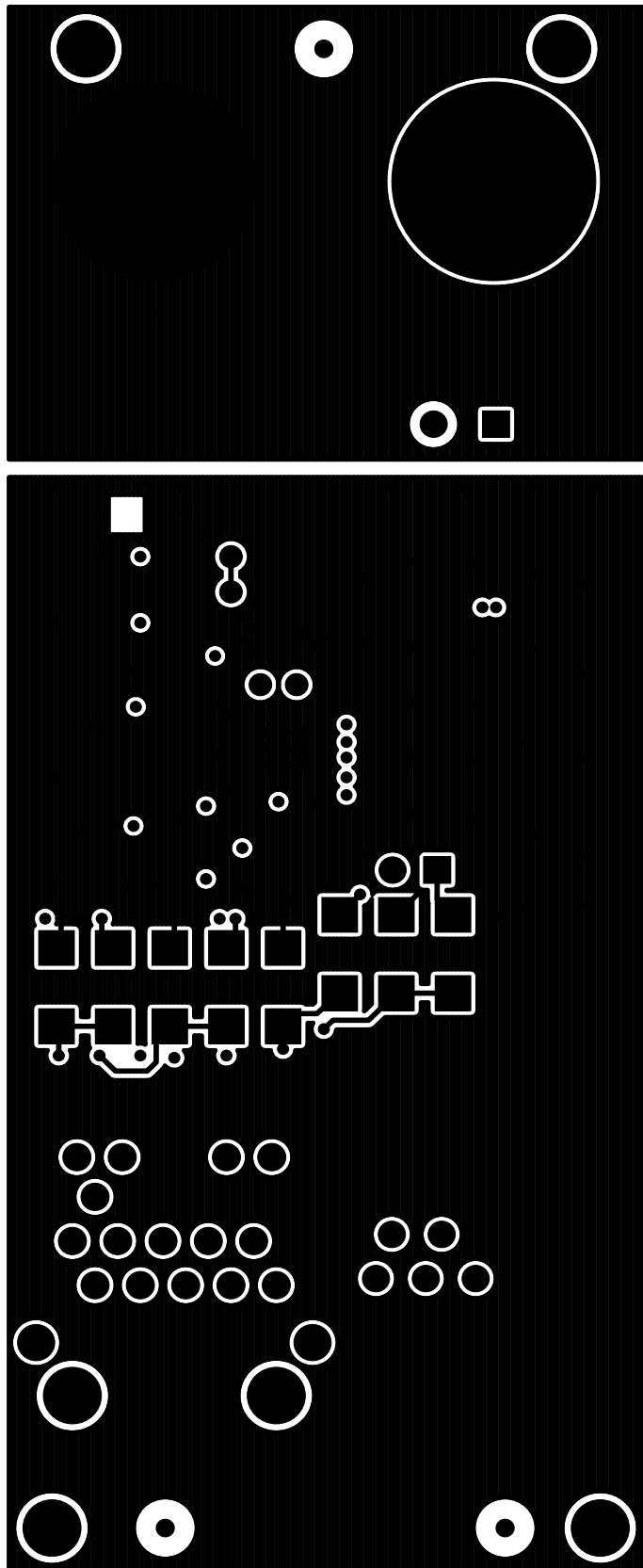

Figure 6. Bottom Layer

# Si3402B-EVB

## 3. Bill of Materials

The table below is the BOM listing for the standard 5 V evaluation board with a popular option for Class 3. For Class 1 and Class 2 designs, in addition to updating the classification resistor (R3), the external diode bridge (D8–D15) can be removed to reduce BOM costs.

**Table 1. Si3402B-EVB Bill of Materials**

NI	Qty	Value	Ref	Rating	V	Tol	Type	PCB Footprint	Mfr Part Number	Mfr
	3	1 $\mu$ F	C1, C3, C4		100 V	$\pm 10\%$	X7R	C1210	C1210X7R101-105K	Venkel
	1	12 $\mu$ F	C2		100 V	$\pm 20\%$	Alum_Elec	C2.5X6.3MM-RAD	EEUFC2A120	Panasonic
	1	560 $\mu$ F	C5		6.3 V	$\pm 20\%$	Alum_Elec	C3.5X8MM-RAD	EEUFM0J561	Panasonic
	1	22 $\mu$ F	C6		6.3 V	$\pm 20\%$	X5R	C0805	C0805X5R6R3-226M	Venkel
	1	1 nF	C7		50 V	$\pm 1\%$	C0G	C0805	C0805C0G500-102F	Venkel
	1	0.1 $\mu$ F	C8		16 V	$\pm 10\%$	X7R	C0805	C0805X7R160-104K	Venkel
	8*	1 nF	C10, C11, C12, C13, C14, C15, C16, C17		100 V	$\pm 10\%$	X7R	C0603	C0603X7R101-102K	Venkel
	1	0.1 $\mu$ F	C18		100 V	$\pm 10\%$	X7R	C0805	C0805X7R101-104K	Venkel
NI	1	150 pF	C19		16 V	$\pm 10\%$	X7R	C0805	C0805X7R160-151K	Venkel
NI	1	3.3 nF	C20		16 V	$\pm 10\%$	X7R	C0805	C0805X7R160-332K	Venkel
	1	PDS5100	D1	5 A	100 V		Schottky	POWERDI-5	PDS5100H-13	Diodes Inc.
	8	SS2150	D8, D9, D10, D11, D12, D13, D14, D15	2 A	150 V		Single	DO-214AC	SS2150-LTP	MCC
	1	30 $\Omega$	FB1	3000 mA			SMT	L0805	BLM21PG300SN1	Murata
	1	RJ-45	J1				Receptacle	RJ45-SI-52004	SI-52003-F	Bel
	2	BND_POST	J11, J12	15 A			Banana	Banana Jack	101	Abbatron Hh Smith
	1	33 $\mu$ H	L1	5.2 A		$\pm 20\%$	Shielded	IND-SPD	MSS1278-333ML	Coilcraft
	4	330 $\Omega$	L2, L3, L4, L5	1500 mA			SMT	L0805	BLM21PG331SN1	MuRata
	1	330 $\Omega$	R1	1/10 W		$\pm 1\%$	ThickFilm	R0805	CR0805-10W-3300F	Venkel
	1	49.9 k $\Omega$	R2	1/8 W		$\pm 1\%$	ThickFilm	R0805	CR0805-8W-4992F	Venkel
	1	48.7 $\Omega$	R3	1/8 W		$\pm 1\%$	ThickFilm	R0805	CRCW080548R7FKTA	Vishay
	1	24.3 k $\Omega$	R4	1/8 W		$\pm 1\%$	ThickFilm	R0805	CRCW080524K3FKEA	Vishay
	1	3.24 k $\Omega$	R5	1/8 W		$\pm 1\%$	ThickFilm	R0805	CRCW08053K24FKEA	Vishay
	1	8.66 k $\Omega$	R6	1/10 W		$\pm 1\%$	ThickFilm	R0805	CR080510W-8661F	Venkel
	1	47 k $\Omega$	R7	1/10 W		$\pm 5\%$	ThickFilm	R0805	CR0805-10W-473J	Venkel
	1	100 $\Omega$	R9	1/2 W		$\pm 1\%$	ThickFilm	R1210	CR1210-2W-1000F	Venkel
NI	5	Black	TP2, TP3, TP4, TP5, TP6				Loop	Testpoint	5001	Keystone
	1	Si3402B	U1		100 V		PD	QFN20N5X5P0.8	Si3402B	SiLabs

\*Note: C10–C17 are populated by default. See the “Surge” section in AN956 for more information.



## 4. BOM Options

The Si3402B non-isolated EVB has been compensated for eight different output voltage and filter combinations:

- 3.3 V output standard ESR 1000  $\mu$ F 6.3 V filter
- 5 V output standard ESR 1000  $\mu$ F 6.3 V filter
- 9 V output standard ESR 470  $\mu$ F 16 V filter
- 12 V output standard ESR 470  $\mu$ F 16 V filter
- 3.3 V output low ESR 560  $\mu$ F 6.3 V filter
- 5 V output low ESR 560  $\mu$ F 6.3 V filter
- 9 V output low ESR 330  $\mu$ F 16 V filter
- 12 V output low ESR 330  $\mu$ F 16 V filter

For the standard ESR capacitor, the ESR increase at very low temperatures may cause a loop stability issue. A typical evaluation board has been shown to exhibit instability under very heavy loads at  $-20^{\circ}\text{C}$ . Due to self-heating, this condition is not a great concern. However, using a low ESR filter capacitor solves this problem (but requires some recompensation of the feedback loop). The low ESR capacitor also improves load transient response and output ripple.

The Si3402B (non-isolated) EVB was designed with a very simple compensation consisting of R7 and C7.

The standard evaluation board is optimized for a standard ESR filter capacitor for 5 V output.

The following table gives the options that have been tested for other situations.

$V_{\text{OUT}}$	R6 (To Adjust Output Voltage)	Filter Cap C5 (Type FM are Low ESR)	Filter Cap Part Number (Panasonic)	R7	C7
3.3 V	4.64 k $\Omega$	1000 $\mu$ F, 6.3 V	ECA0JM102	47 k $\Omega$	1 nF
3.3 V	4.64 k $\Omega$	560 $\mu$ F, 6.3 V	EEUFM0J561	47 k $\Omega$	1 nF
5.0 V	8.66 k $\Omega$	1000 $\mu$ F, 6.3 V	ECA0JM102	47 k $\Omega$	1 nF
5.0 V	8.66 k $\Omega$	560 $\mu$ F, 6.3 V	EEUFM0J561	47 k $\Omega$	1 nF
9.0 V	18.2 k $\Omega$	470 $\mu$ F, 16 V	ECA1CM471	47 k $\Omega$	1 nF
9.0 V	18.2 k $\Omega$	330 $\mu$ F, 16 V	EEUFM1C331	47 k $\Omega$	1 nF
12.0 V	25.5 k $\Omega$	470 $\mu$ F, 16 V	ECA1CM471	47 k $\Omega$	1 nF
12.0 V	25.5 k $\Omega$	330 $\mu$ F, 16 V	EEUFM1C331	47 k $\Omega$	1 nF

### Introduction

Although the EVB design is pre-configured as a Class 3 PD with 5 V output, the schematics and layouts can easily be adapted to meet a wide variety of common output voltages and power levels.

The complete EVB design databases for the standard 5 V/Class 3 configuration are located at [www.silabs.com/PoE](http://www.silabs.com/PoE) under the “Documentation” link. Silicon Labs strongly recommends using these EVB schematics and layout files as a starting point to ensure robust performance and avoid common mistakes in the schematic capture and PCB layout processes.

Following are recommended design checklists that can assist in trouble-free development of robust PD designs.

Refer also to the Si3402B data sheet and AN956 when using the following checklists.

#### 1. Design Planning Checklist:

- a. Determine if your design requires an isolated or non-isolated topology. For more information, see Section 4 of AN956.
- b. Silicon Labs strongly recommends using the EVB schematics and layout files as a starting point as you begin integrating the Si3402B into your system design process.
- c. Determine your load’s power requirements (i.e.,  $V_{OUT}$  and  $I_{OUT}$  consumed by the PD, including the typical expected transient surge conditions). In general, to achieve the highest overall efficiency performance of the Si3402B, choose the highest voltage used in your PD and then post regulate to the lower supply rails, if necessary.
- d. If your PD design consumes  $\geq 7$  W, be sure to bypass the Si3402B’s on-chip diode bridges with external Schottky diode bridges or discrete diodes. Bypassing the Si3402B’s on-chip diode bridges with external bridges or discrete Schottky diodes is required to help spread the heat generated in designs dissipating  $\geq 7$  W.
- e. Based on your required PD power level, select the appropriate class resistor value by referring to Table 3 of AN956. This sets the Rclass resistor (R3 in Figure 1 on page 2).

#### 2. General design checklist items:

- a. ESD caps (C10–C17 in Figure 1) are strongly recommended for designs where system-level ESD (IEC6100-4-2) must provide  $>15$  kV tolerance.
- b. If your design uses an AUX supply, be sure to include a 3 W surge limiting resistor in series with the AUX supply for hot insertion. Refer to AN956 when AUX supply is 48 V.
- c. Silicon Labs strongly recommends the inclusion of a minimum load (250 mW) to avoid switcher pulsing when no load is present and to avoid false disconnection when less than 10 mA is drawn from the PSE. If your load is not at least 250 mW, add a resistor load to dissipate at least 250 mW.
- d. If using PLOSS function, make sure it’s properly terminated for connection in your PD subsystem. If PLOSS is not needed, leave this pin floating.

#### 3. Layout guidelines:

- a. Make sure VNEG pin of the Si3402B is connected to the backside of the QFN package with an adequate thermal plane, as noted in the data sheet and AN956.
- b. Keep the trace length from connecting to SWO and retuning to Vss2 as short as possible. Make all of the power (high current) traces as short, direct, and thick as possible. It is a good practice on a standard PCB board to make the traces an absolute minimum of 15 mils (0.381 mm) per Ampere.
- c. Usually, one standard via handles 200 mA of current. If the trace needs to conduct a significant amount of current from one plane to the other, use multiple vias.

- d. Keep the circular area of the loop from the Switcher FET output to the inductor or transformer and returning from the input filter capacitors (C1–C4) to Vss2 as small a diameter as possible. Also, minimize the circular area of the loop from the output of the inductor or transformer to the Schottky diode and returning through the first stage output filter capacitor back to the inductor or transformer as small as possible. If possible, keep the direction of current flow in these two loops the same.
- e. Keep the high power traces as short as possible.
- f. Keep the feedback and loop stability components as far from the transformer/inductor and noisy power traces as possible.
- g. If the outputs have a ground plane or positive output plane, do not connect the high current carrying components and the filter capacitors through the plane. Connect them together, and then connect to the plane at a single point.
- h. As a convenience in layout, please note that the IC is symmetrical with respect to CT1, CT2, SP1, and SP2. These leads can be interchanged. At least one pair of CT1/CT2 or SP1/SP2 should be connected.

To help ensure first-pass success, submit your schematics and layout files to [PoEInfo@silabs.com](mailto:PoEInfo@silabs.com) for review. Other technical questions may be sent to this e-mail address as well.

## DOCUMENT CHANGE LIST

### Revision 1.0 to Revision 1.1

- Initial release of Si3402B-EVB User's Guide, modified from Si3402-EVB User's Guide Revision 1.0.

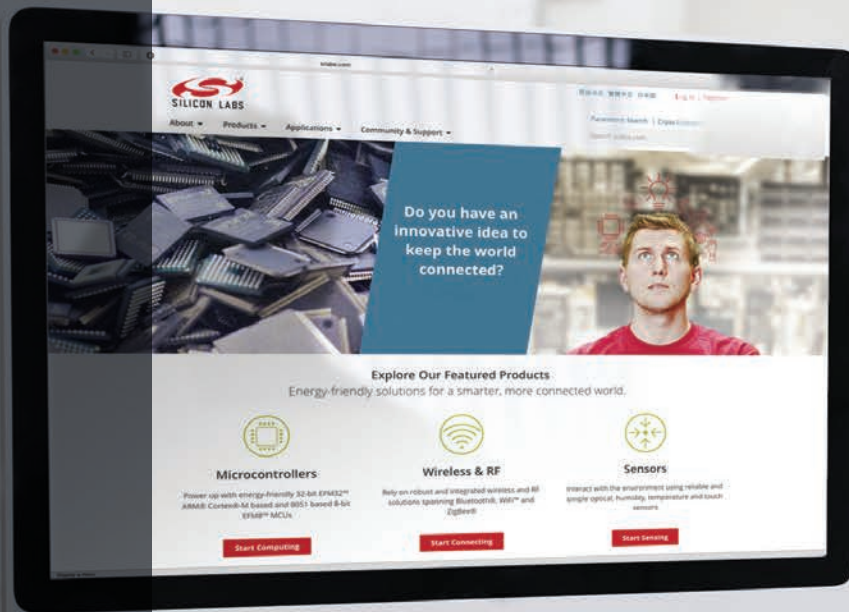

Smart.  
Connected.  
Energy-Friendly.



**Products**  
[www.silabs.com/products](http://www.silabs.com/products)

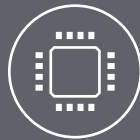

**Quality**  
[www.silabs.com/quality](http://www.silabs.com/quality)



**Support and Community**  
[community.silabs.com](http://community.silabs.com)

**Disclaimer**

Silicon Labs intends to provide customers with the latest, accurate, and in-depth documentation of all peripherals and modules available for system and software implementers using or intending to use the Silicon Labs products. Characterization data, available modules and peripherals, memory sizes and memory addresses refer to each specific device, and "Typical" parameters provided can and do vary in different applications. Application examples described herein are for illustrative purposes only. Silicon Labs reserves the right to make changes without further notice to the product information, specifications, and descriptions herein, and does not give warranties as to the accuracy or completeness of the included information. Without prior notification, Silicon Labs may update product firmware during the manufacturing process for security or reliability reasons. Such changes will not alter the specifications or the performance of the product. Silicon Labs shall have no liability for the consequences of use of the information supplied in this document. This document does not imply or expressly grant any license to design or fabricate any integrated circuits. The products are not designed or authorized to be used within any FDA Class III devices, applications for which FDA premarket approval is required or Life Support Systems without the specific written consent of Silicon Labs. A "Life Support System" is any product or system intended to support or sustain life and/or health, which, if it fails, can be reasonably expected to result in significant personal injury or death. Silicon Labs products are not designed or authorized for military applications. Silicon Labs products shall under no circumstances be used in weapons of mass destruction including (but not limited to) nuclear, biological or chemical weapons, or missiles capable of delivering such weapons. Silicon Labs disclaims all express and implied warranties and shall not be responsible or liable for any injuries or damages related to use of a Silicon Labs product in such unauthorized applications.

**Trademark Information**

Silicon Laboratories Inc.®, Silicon Laboratories®, Silicon Labs®, SiLabs® and the Silicon Labs logo®, Bluegiga®, Bluegiga Logo®, ClockBuilder®, CMEMS®, DSPLL®, EFM®, EFM32®, EFR, Ember®, Energy Micro, Energy Micro logo and combinations thereof, "the world's most energy friendly microcontrollers", Ember®, EZLink®, EZRadio®, EZRadioPRO®, Gecko®, Gecko OS, Gecko OS Studio, ISOModem®, Precision32®, ProSLIC®, Simplicity Studio®, SiPHY®, Telegesis, the Telegesis Logo®, USBXpress®, Zentri, the Zentri logo and Zentri DMS, Z-Wave®, and others are trademarks or registered trademarks of Silicon Labs. ARM, CORTEX, Cortex-M3 and THUMB are trademarks or registered trademarks of ARM Holdings. Keil is a registered trademark of ARM Limited. Wi-Fi is a registered trademark of the Wi-Fi Alliance. All other products or brand names mentioned herein are trademarks of their respective holders.



Silicon Laboratories Inc.  
400 West Cesar Chavez  
Austin, TX 78701  
USA

<http://www.silabs.com>

## X-ON Electronics

Largest Supplier of Electrical and Electronic Components

*Click to view similar products for [Power Management IC Development Tools](#) category:*

*Click to view products by [Silicon Labs](#) manufacturer:*

Other Similar products are found below :

[EVAL6482H-DISC](#) [EVAL-AD5522EBUZ](#) [EVAL-ADM1060EBZ](#) [EVAL-ADM1073MEBZ](#) [EVAL-ADM1166TQEBZ](#) [EVAL-ADM1168LQEBZ](#) [EVAL-ADM1171EBZ](#) [EVAL-ADM1276EBZ](#) [EVB-EN5319QI](#) [EVB-EN5365QI](#) [EVB-EN6347QI](#) [EVB-EP5348UI](#) [MIC23158YML EV](#) [MIC23451-AAAYFL EV](#) [MIC5281YMME EV](#) [124352-HMC860LP3E](#) [ADM00513](#) [ADM8611-EVALZ](#) [ADM8612-EVALZ](#) [ADM8613-EVALZ](#) [ADM8615-EVALZ](#) [ADP1046ADC1-EVALZ](#) [ADP1055-EVALZ](#) [ADP122-3.3-EVALZ](#) [ADP130-0.8-EVALZ](#) [ADP130-1.2-EVALZ](#) [ADP130-1.5-EVALZ](#) [ADP130-1.8-EVALZ](#) [ADP160UJZ-REDYKIT](#) [ADP166UJ-EVALZ](#) [ADP1712-3.3-EVALZ](#) [ADP1714-3.3-EVALZ](#) [ADP1715-3.3-EVALZ](#) [ADP1716-2.5-EVALZ](#) [ADP1740-1.5-EVALZ](#) [ADP1752-1.5-EVALZ](#) [ADP1754-1.5-EVALZ](#) [ADP1828LC-EVALZ](#) [ADP1870-0.3-EVALZ](#) [ADP1871-0.6-EVALZ](#) [ADP1873-0.6-EVALZ](#) [ADP1874-0.3-EVALZ](#) [ADP1876-EVALZ](#) [ADP1879-1.0-EVALZ](#) [ADP1882-1.0-EVALZ](#) [ADP1883-0.6-EVALZ](#) [ADP197CB-EVALZ](#) [ADP199CB-EVALZ](#) [ADP2102-1.25-EVALZ](#) [ADP2102-1.2-EVALZ](#)