

SE01P13K

P-Channel Enhancement Mode Power MOSFET

Revision: A

General Description

Advanced trench technology to provide excellent RDS(ON), low gate charge and low operation voltage. This device is suitable for using as a load switch or in PWM applications.

- Simple Drive Requirement
- Small Package Outline
- Surface Mount Device

Features

For a single MOSFET

- $V_{DS} = -100V$
- $R_{DS(ON)} = 170m\Omega @ V_{GS}=-10V$

Pin configurations

See Diagram below



Absolute Maximum Ratings

Parameter		Symbol	Rating	Units
Drain-Source Voltage		V_{DS}	-100	V
Gate-Source Voltage		V_{GS}	± 20	V
Drain Current	Continuous	I_D	-13	A
	Pulsed		-30	
Total Power Dissipation	@TA=25°C	P_D	40	W
Single Pulse Avalanche Energy		E_{AS}	110	mJ
Operating Junction Temperature Range		T_J	-55 to 150	°C

Thermal Resistance

Symbol	Parameter	Typ	Max	Units
$R_{\theta JC}$	Thermal Resistance, Junction to Case	-	3.13	°C/W

SE01P13K

Electrical Characteristics (T _J =25°C unless otherwise noted)						
Symbol	Parameter	Test Conditions	Min	Typ	Max	Units
OFF CHARACTERISTICS (Note 2)						
B _V DSS	Drain-Source Breakdown Voltage	I _D =-250μA, V _{GS} =0 V	-100			V
I _{DSS}	Drain to Source Leakage Current	V _{DS} =-100V, V _{GS} =0V			-1	μA
I _{GSS}	Gate-Body Leakage Current	V _{GS} =20V			10	μA
V _{GS(th)}	Gate Threshold Voltage	V _{DS} = V _{GS} , I _D =250μA	-1	-1.9	-3	V
R _{DS(ON)}	Static Drain-Source On-Resistance	V _{GS} =-10V, I _D =-16A	-	170	200	mΩ
g _{fs}	Forward Transconductance	V _{DS} =-15V, I _D =-5A	12			S
DYNAMIC PARAMETERS						
C _{iss}	Input Capacitance	V _{GS} =0V, V _{DS} =-25V, f=1MHz		760		pF
C _{oss}	Output Capacitance			260		pF
C _{rss}	Reverse Transfer Capacitance			170		pF
SWITCHING PARAMETERS						
t _{d(on)}	Turn-On Delay Time	V _{DS} =-50V, V _{GS} =-10V R _{GEN} =9.1Ω, I _D =-10A		14		ns
t _{d(off)}	Turn-Off Delay Time			50		ns
t _{d(r)}	Turn-On Rise Time			18		ns
t _{d(f)}	Turn-Off Fall Time			18		ns
Source-Drain Ratings and Characteristics						
I _S	Continuous Source Current				130	mA
V _{SD}	Diode Forward Voltage	I _S =-10A, V _{GS} =0V			-1.2	V
t _{rr}	Reverse Recovery Time	T _J =25°C, I _F =-10A		35		nS
Q _{rr}	Reverse Recovery Charge	di/dt=100A/μs		46		nc

Test Circuits and Waveform

1) E_{AS} Test Circuit

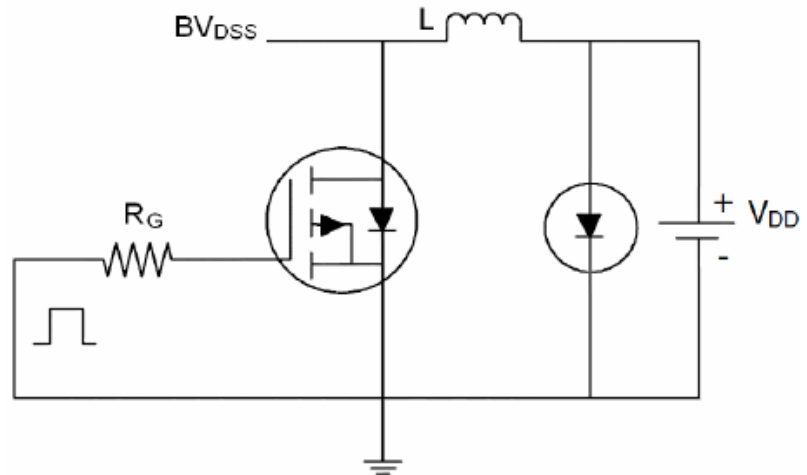

2) Gate Charge Test Circuit

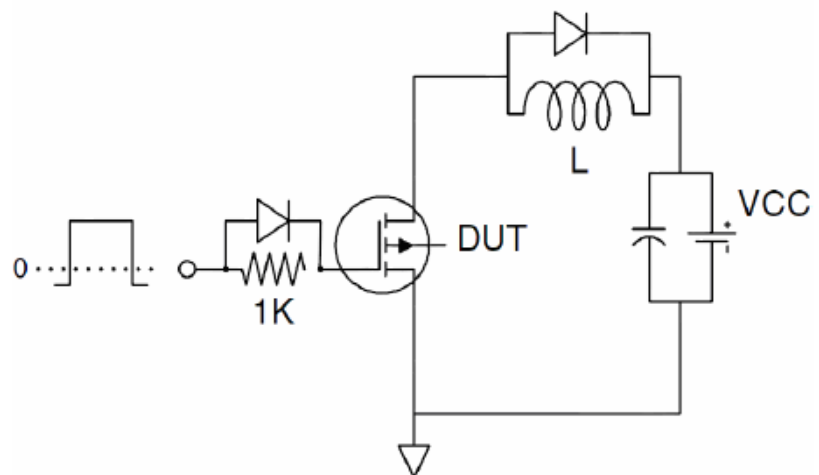

3) Switch Time Test Circuit

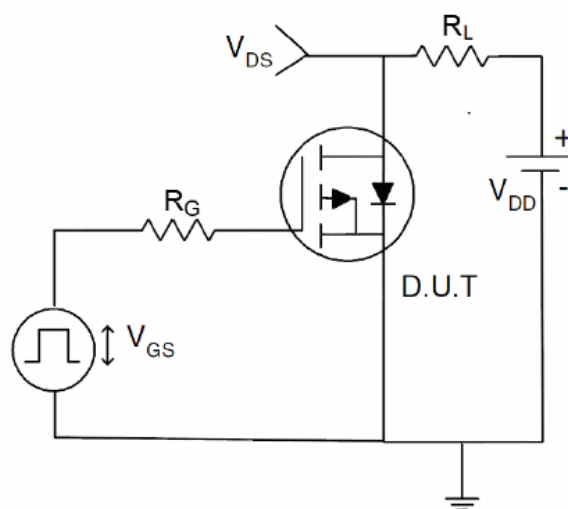

Typical Characteristics

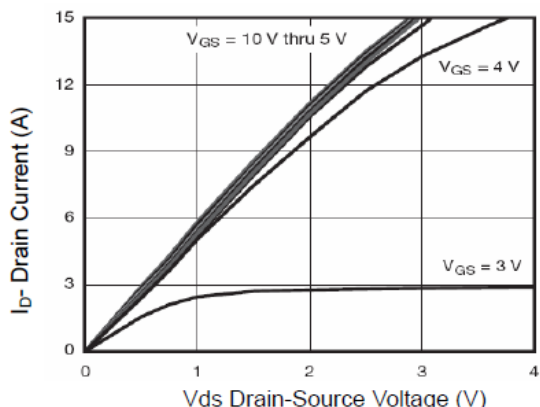

Figure 1 Output Characteristics

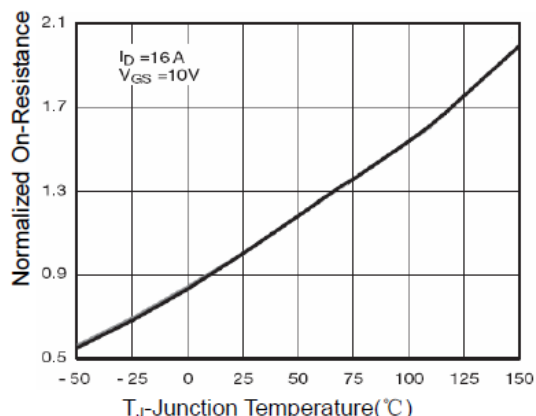

Figure 4 Rdson-Junction Temperature

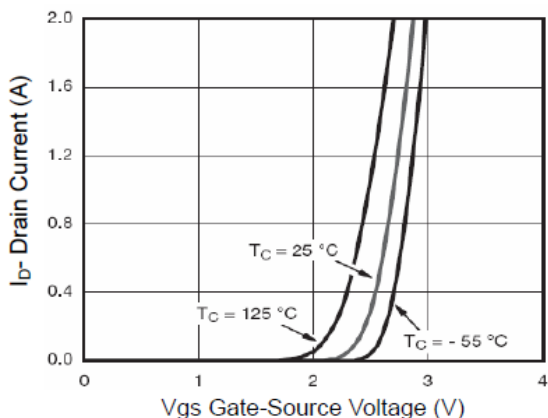

Figure 2 Transfer Characteristics

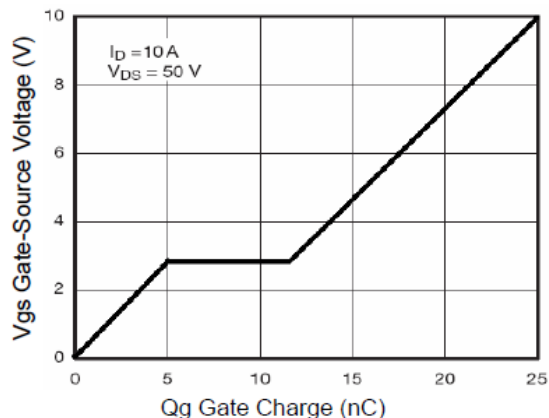

Figure 5 Gate Charge

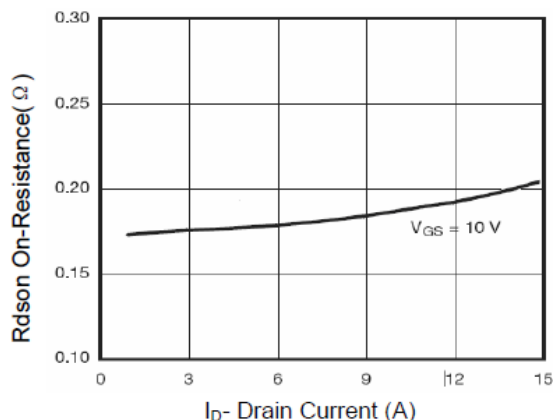

Figure 3 Rdson- Drain Current

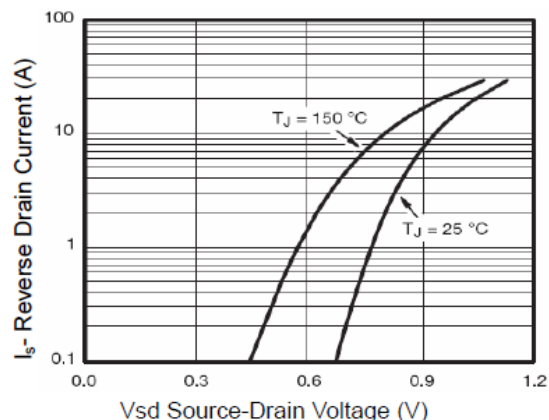

Figure 6 Source- Drain Diode Forward

Typical Characteristics

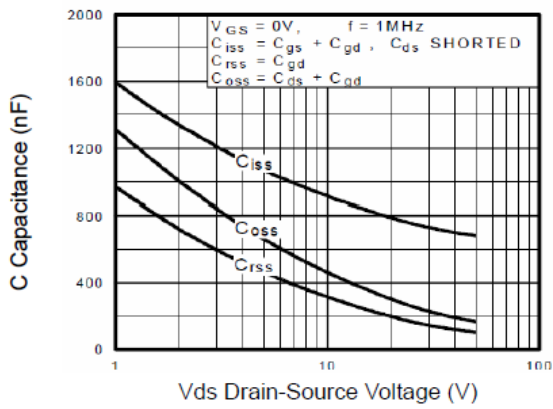

Figure 7 Capacitance vs Vds

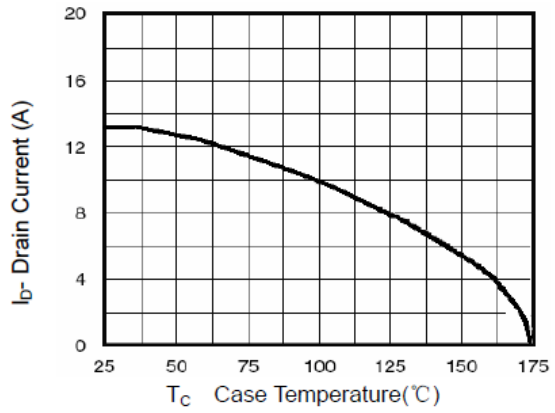

Figure 9 Drain Current vs Case Temperature

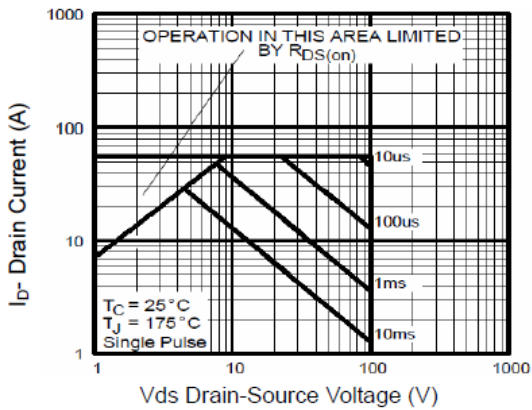

Figure 8 Safe Operation Area

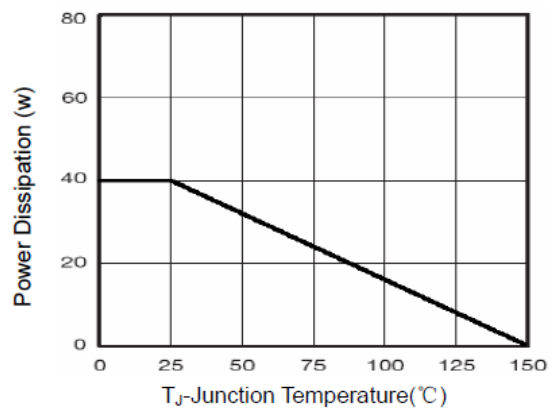

Figure 10 Power De-rating

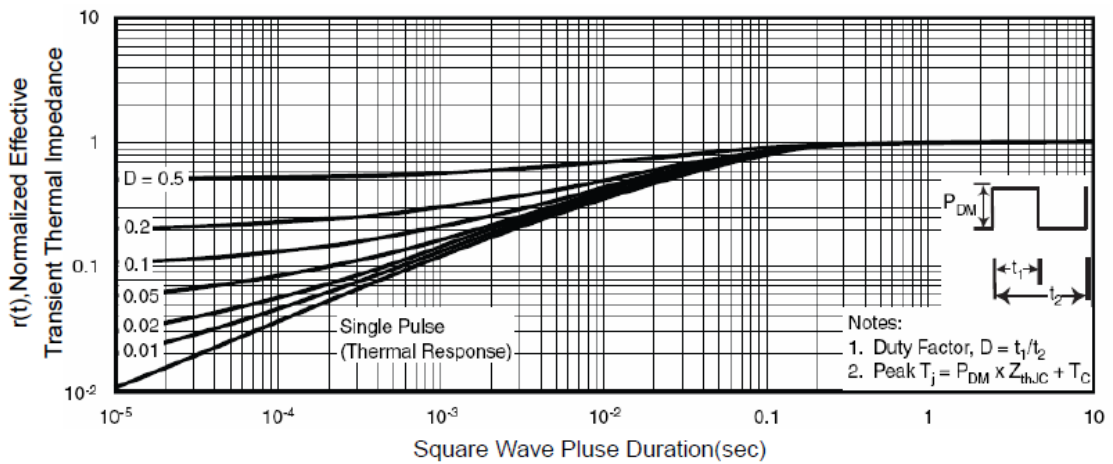
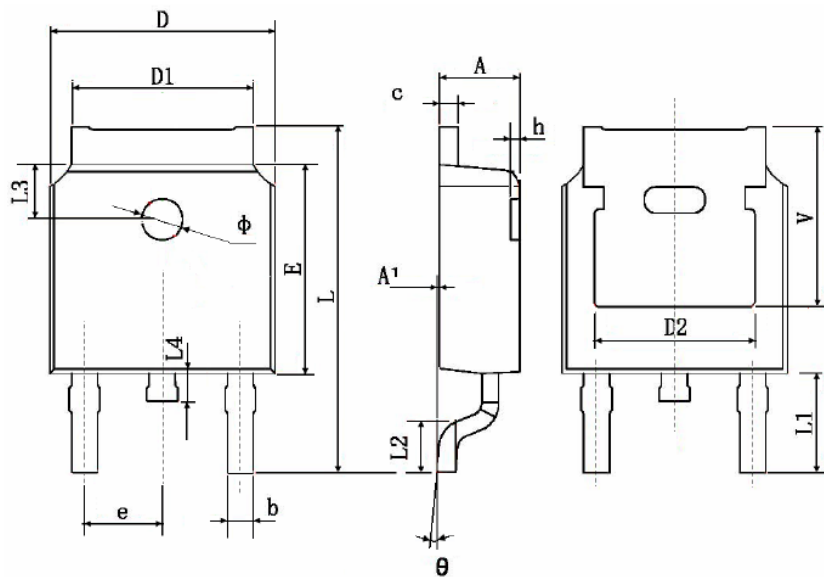

Figure 11 Normalized Maximum Transient Thermal Impedance

SE01P13K

Package Outline Dimension

TO-252



Symbol	Dimensions In Millimeters		Dimensions In Inches	
	Min.	Max.	Min.	Max.
A	2.200	2.400	0.087	0.094
A1	0.000	0.127	0.000	0.005
b	0.660	0.860	0.026	0.034
c	0.460	0.580	0.018	0.023
D	6.500	6.700	0.256	0.264
D1	5.100	5.460	0.201	0.215
D2	4.830 TYP.		0.190 TYP.	
E	6.000	6.200	0.236	0.244
e	2.186	2.386	0.086	0.094
L	9.800	10.400	0.386	0.409
L1	2.900 TYP.		0.114 TYP.	
L2	1.400	1.700	0.055	0.067
L3	1.600 TYP.		0.063 TYP.	
L4	0.600	1.000	0.024	0.039
phi	1.100	1.300	0.043	0.051
theta	0°	8°	0°	8°
h	0.000	0.300	0.000	0.012
V	5.350 TYP.		0.211 TYP.	

The SINO-IC logo is a registered trademark of ShangHai Sino-IC Microelectronics Co., Ltd.

© 2005 SINO-IC - Printed in China - All rights reserved.

SHANGHAI SINO-IC MICROELECTRONICS CO., LTD

Add: Building 3, Room 3401-03, No.200 Zhangheng Road,
ZhangJiang Hi-Tech Park, Pudong, Shanghai 201203, China

Phone: +86-21-33932402 33932403

33932405 33933508 33933608

Fax: +86-21-33932401

Email: szrxw002@126.com

Website: <http://www.sino-ic.net>

X-ON Electronics

Largest Supplier of Electrical and Electronic Components

Click to view similar products for [MOSFET](#) category:

Click to view products by [SINO-IC](#) manufacturer:

Other Similar products are found below :

[614233C](#) [648584F](#) [IRFD120](#) [IRFF430](#) [JANTX2N5237](#) [2N7000](#) [FCA20N60_F109](#) [FDZ595PZ](#) [AOD464](#) [2SK2267\(Q\)](#) [2SK2545\(Q,T\)](#)
[405094E](#) [423220D](#) [MIC4420CM-TR](#) [VN1206L](#) [614234A](#) [715780A](#) [SSM6J414TU,LF\(T](#) [751625C](#) [PSMN4R2-30MLD](#)
[TK31J60W5,S1VQ\(O](#) [2SK2614\(TE16L1,Q\)](#) [DMN1017UCP3-7](#) [EFC2J004NUZTDG](#) [FCAB21350L1](#) [P85W28HP2F-7071](#) [DMN1053UCP4-7](#)
[NTE2384](#) [NTE2969](#) [NTE6400A](#) [DMN2080UCB4-7](#) [DMN61D9UWQ-13](#) [US6M2GTR](#) [DMN31D5UDJ-7](#) [SSM6P54TU,LF](#) [DMP22D4UFO-](#)
[7B](#) [IPS60R3K4CEAKMA1](#) [DMN1006UCA6-7](#) [DMN16M9UCA6-7](#) [STF5N65M6](#) [STU5N65M6](#) [C3M0021120D](#) [DMN13M9UCA6-7](#)
[BSS340NWH6327XTSA1](#) [MCM3400A-TP](#) [DMTH10H4M6SPS-13](#) [IRF40SC240ARMA1](#) [IPS60R1K0PFD7SAKMA1](#)
[IPS60R360PFD7SAKMA1](#) [IPS60R600PFD7SAKMA1](#)