

SE12N50FRA

N-Channel Enhancement-Mode MOSFET with FR

Revision: A

General Description

High Density Cell Design For Ultra Low On-Resistance Fully Characterized Avalanche Voltage and Current Improved Shoot-Through FOM

- Simple Drive Requirement
- Small Package Outline
- Surface Mount Device

Features

For a single MOSFET

- $V_{DS} = 500V$
- $R_{DS(ON)} = 0.58\Omega @ V_{GS}=10V$

Pin configurations

See Diagram below

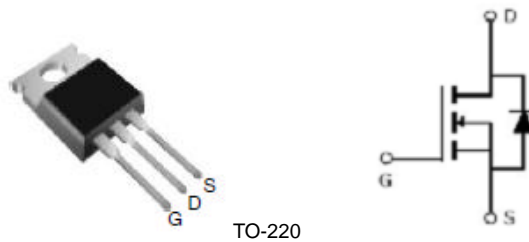

Absolute Maximum Ratings

Parameter		Symbol	Rating	Units
Drain-Source Voltage		V_{DS}	500	V
Gate-Source Voltage		V_{GS}	± 30	V
Drain Current	Continuous	I_D	12	A
	Pulsed		48	
Avalanche Energy, Single Pulse		E_{AS}	140	mJ
Avalanche Energy, Repetitive		E_{AR}	0.3	mJ
Continuous Diode Forward Current		I_S	8.7	A
Diode Pulse Current		$I_{S, Pulse}$	26.1	A
Total Power Dissipation @TC=25°C		P_D	83	W
Operating Junction Temperature Range		T_J	-55 to 150	°C

Thermal Resistance

Symbol	Parameter	Min	Max	Units
$R_{\theta JC}$	Junction to Case		4.0	°C/W
$R_{\theta JA}$	Junction to Ambient (t ≤ 10s)		80	°C/W

SE12N50FRA

Electrical Characteristics (T _J =25°C unless otherwise noted)						
Symbol	Parameter	Test Conditions	Min	Typ	Max	Units
OFF CHARACTERISTICS						
B _V DSS	Drain-Source Breakdown Voltage	I _D =250μA, V _{GS} =0V	500			V
I _{DSS}	Drain to Source Leakage Current	V _{DS} =500V, V _{GS} =0V			1	nA
I _{GSS}	Gate-Body Leakage Current	V _{GS} =20V			100	nA
V _{GS(th)}	Gate Threshold Voltage	V _{DS} = V _{GS} , I _D =250μA	3.0	3.5	4.0	V
R _{DS(ON)}	Static Drain-Source On-Resistance	V _{GS} =10V, I _D =7.5A		0.58	0.70	Ω
DYNAMIC PARAMETERS						
C _{iss}	Input Capacitance	V _{GS} =0V, V _{DS} =25V, f=1MHz		739		pF
C _{oss}	Output Capacitance			58		pF
C _{rss}	Reverse Transfer Capacitance			40		pF
SWITCHING PARAMETERS						
Q _g	Total Gate Charge ²	V _{GS} =10V, V _{DS} =15V, I _D =12A		20		nC
Q _{gs}	Gate Source Charge			4.3		nC
Q _{gd}	Gate Drain Charge			7.6		nC
t _{d(on)}	Turn-On Delay Time	V _{GS} =10V, V _{DS} =50V, R _{GEN} =18Ω I _D =8A		11		ns
t _{d(off)}	Turn-Off Delay Time			29		ns
t _{d(r)}	Turn-On Rise Time			31		ns
t _{d(f)}	Turn-Off Fall Time			28		ns
Source-Drain Ratings and Characteristics						
V _{SD}	Diode Forward Voltage	V _{GS} =0V, I _S =12A		0.89	1.1	V
t _{rr}	Reverse Recovery Time	V _R =400V, I _F =15A dI _F /dt=100A/μs		63		ns
Q _{rr}	Reverse Recovery Charge			390		nC
I _{rrm}	Peak Reverse Recovery Current			7.7		A

Typical Characteristics

Figure 3: Power Dissipation

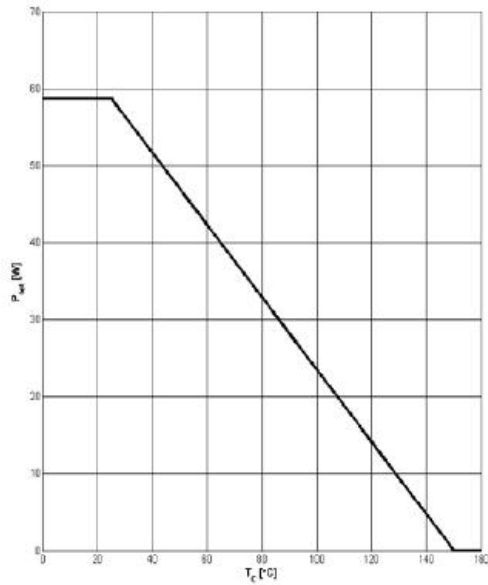

$P_{tot} = f(T_c)$

Figure 4: Max. Transient Thermal Impedance

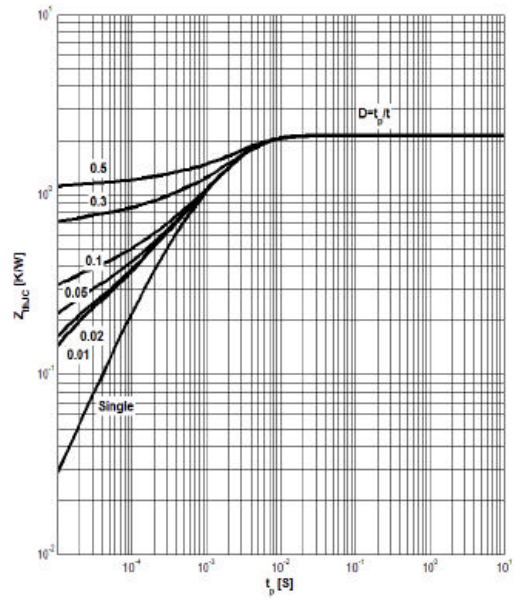

$Z_{thJC} = f(t_p)$; parameter: $D = t_p/T$

Figure 5: Safe Operating Area

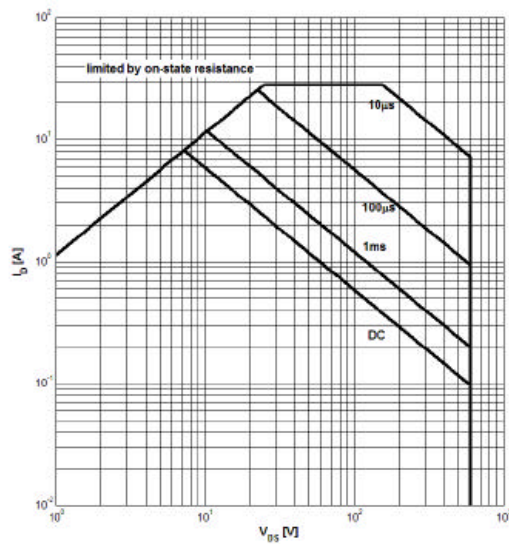

$I_D = f(V_{DS})$; $T_c = 25^{\circ}C$; $V_{GS} > 7V$; parameter t_p

Figure 6: Safe Operating Area

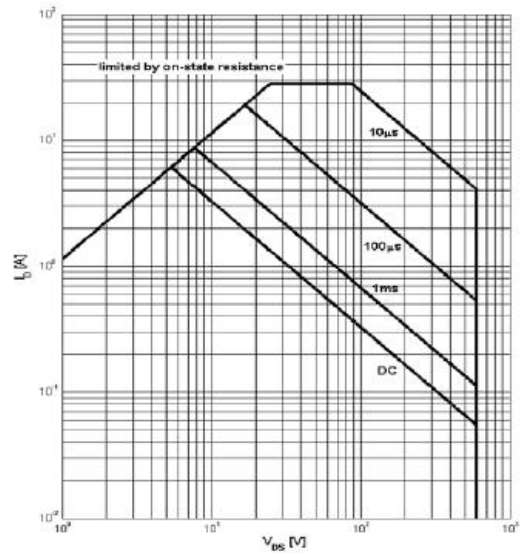

$I_D = f(V_{DS})$; $T_c = 80^{\circ}C$; $V_{GS} > 7V$; parameter t_p

Figure 7: Typ. Output Characteristics

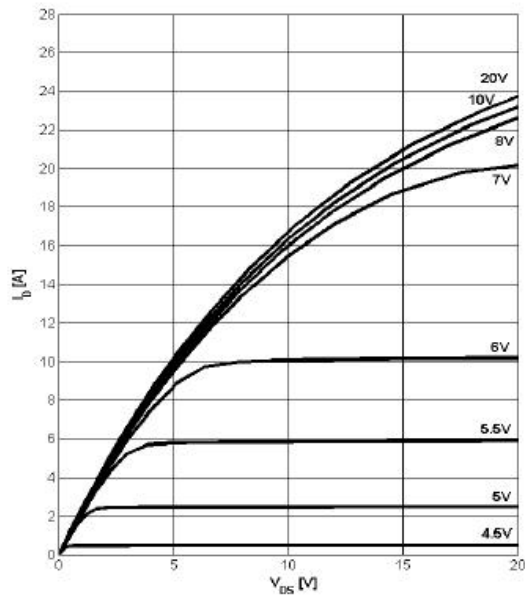

$I_D = f(V_{DS})$; $T_j = 25^\circ\text{C}$; parameter: V_{GS}

Figure 8: Typ. Output Characteristics

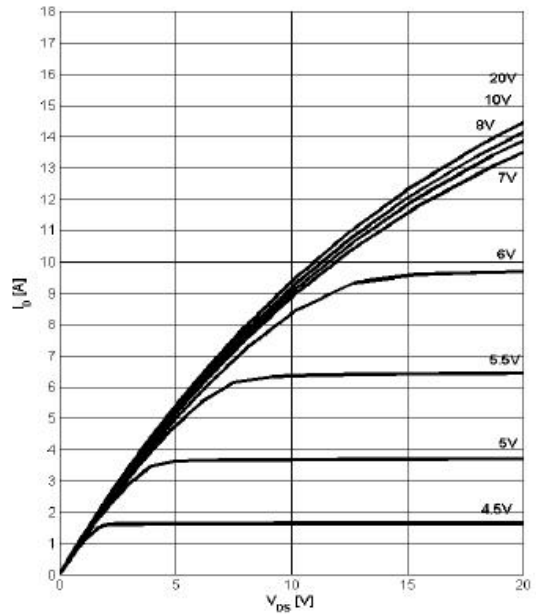

$I_D = f(V_{DS})$; $T_j = 125^\circ\text{C}$; parameter: V_{GS}

Figure 9: Typ. Drain-Source On-State Resistance

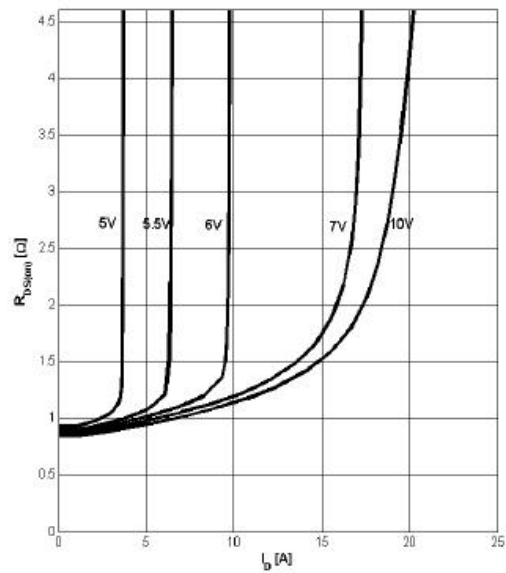

$R_{DS(on)} = f(I_D)$; $T_j = 125^\circ\text{C}$; parameter: V_{GS}

Figure 10: Typ. Drain-Source On-State Resistance

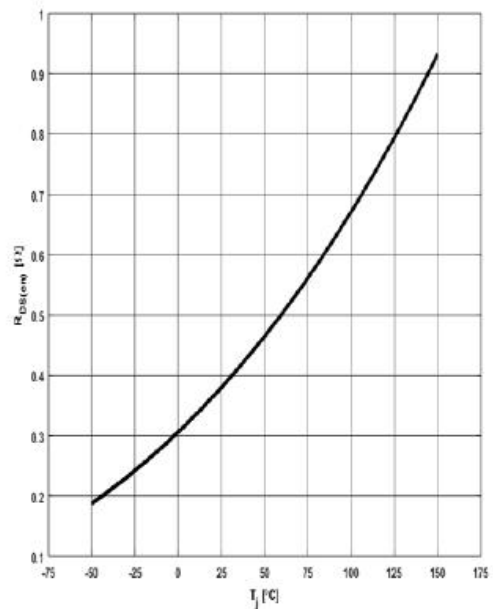

$R_{DS(on)} = f(T_j)$; $I_D = 4.5\text{A}$; $V_{GS} = 10\text{V}$

Figure 11: Typ. Transfer Characteristics

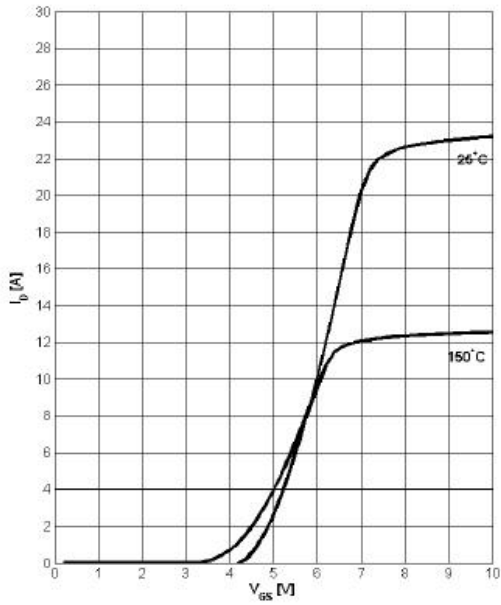

$I_D = f(V_{GS}); V_{DS} = 20V$

Figure 12: Typ. Gate Charge

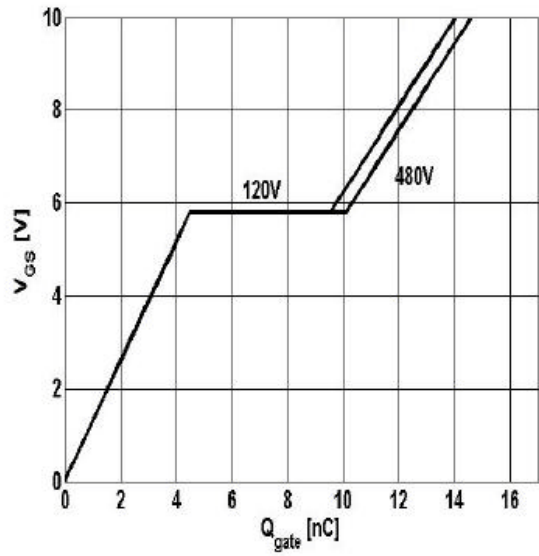

$V_{GS} = f(Q_{gate}), I_D = 4.5A$ pulsed

Figure 13: Drain-Source Breakdown Voltage

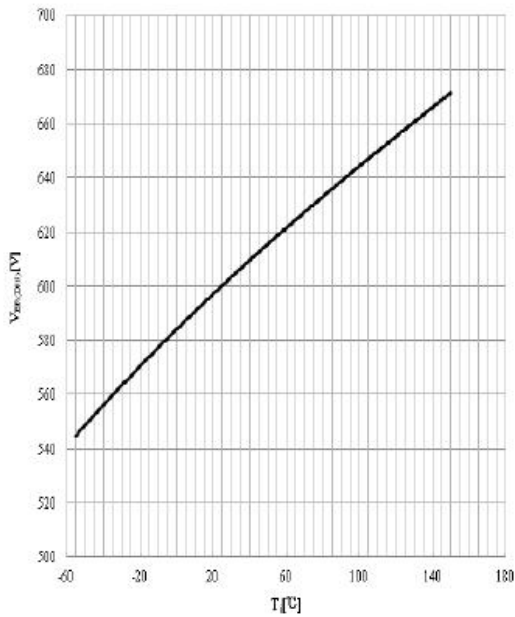

$V_{BR(DSS)} = f(T_j); I_D = 1mA$

Figure 14: Forward Characteristics of Reverse Diode

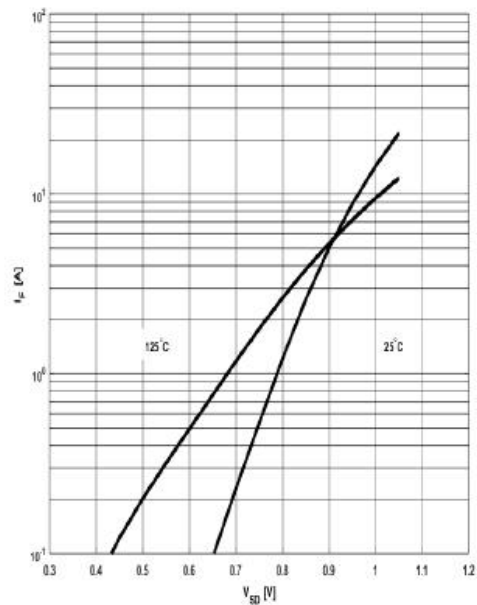

$I_F = f(V_{SD});$ parameter: T_j

SE12N50FRA

Package Outline Dimension

TO-220

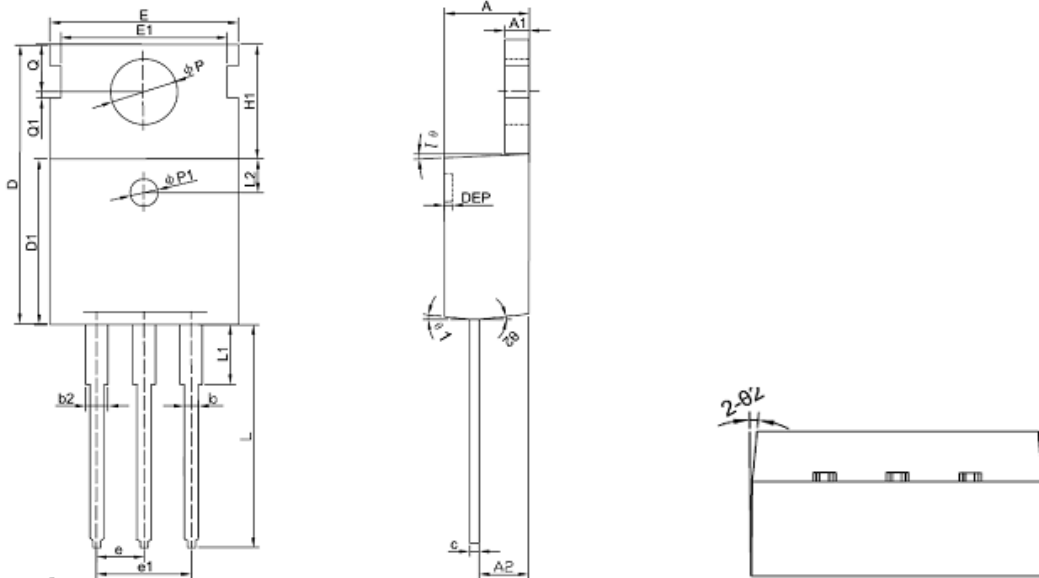

Symbol	Dimension In Millimeters			Dimension In Inches		
	Min	Nom	Max	Min	Nom	Max
A	4.400	4.550	4.700	0.173	0.179	0.185
A1	1.270	1.300	1.330	0.050	0.051	0.052
A2	2.590	2.690	2.790	0.102	0.106	0.110
b	0.770	-	0.900	0.030	-	0.035
b2	1.230	-	1.360	0.048	-	0.054
c	0.480	0.500	0.520	0.019	0.020	0.020
D	15.100	15.400	15.700	-	0.606	-
D1	9.000	9.100	9.200	0.354	0.358	0.362
DEP	0.050	0.285	0.520	0.002	0.011	0.020
E	10.060	10.160	10.260	0.396	0.400	0.404
E1	-	8.700	-	-	0.343	-
ΦP1	1.400	1.500	1.600	0.055	0.059	0.063
e	2.54BSC			0.1BSC		
e1	5.08BSC			0.2BSC		
H1	6.100	6.300	6.500	0.240	0.248	0.256
L	12.750	12.960	13.170	0.502	0.510	0.519
L1	-	-	3.950	-	-	0.156
L2	1.85REF			0.073REF		
ΦP	3.570	3.600	3.630	0.141	0.142	0.143
Q	2.730	2.800	2.870	0.107	0.110	0.113
Q1	-	0.200	-	-	0.008	-
θ1	5 ⁰	7 ⁰	9 ⁰	5 ⁰	7 ⁰	9 ⁰
θ2	1 ⁰	3 ⁰	5 ⁰	1 ⁰	3 ⁰	5 ⁰

SE12N50FRA

TO-220F

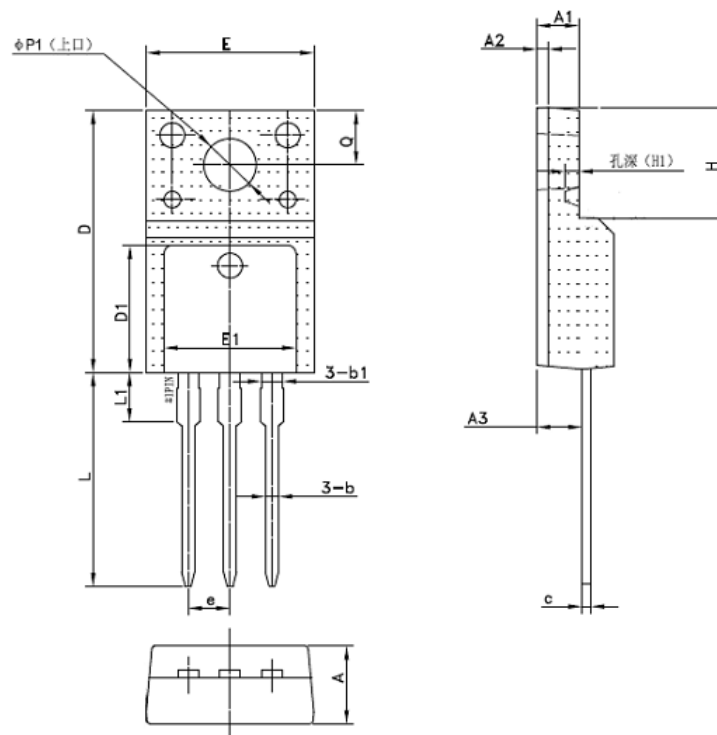

Symbol	Dimensions(mm)		
	Min.	Typ.	Max.
A	4.50	4.70	4.90
A1	2.44	2.54	2.64
A2	0.60	0.70	0.80
A3	2.56	2.76	2.96
b	0.70	0.80	0.95
b1	-	1.28	-
c	0.45	0.50	0.65
D	15.67	15.87	16.07
D1	-	7.70	-
E	9.96	10.16	10.36
E1	-	8.00	-
e	2.54(BSC)		
H	6.50	6.70	6.90
(H1)	-	(0.81)	-
L	12.48	12.98	13.20
L1	-	2.93	-
$\phi P1$	2.98	3.18	3.38
Q	3.10	3.30	3.50

TO-252

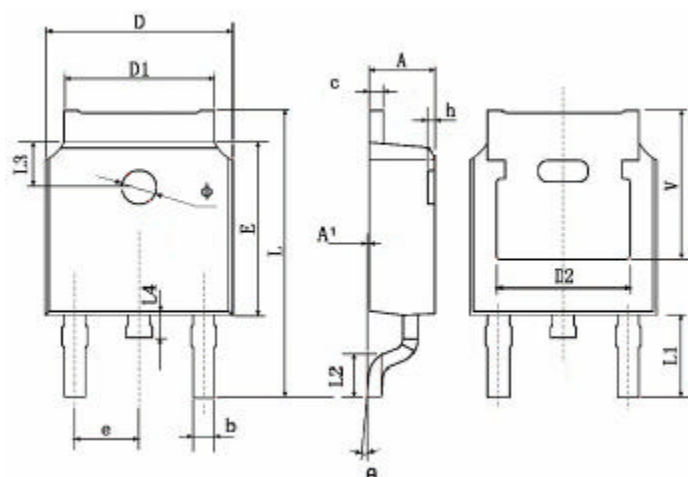

Symbol	Dimensions In Millimeters		Dimensions In Inches	
	Min.	Max.	Min.	Max.
A	2.200	2.400	0.087	0.094
A1	0.000	0.127	0.000	0.005
b	0.660	0.860	0.026	0.034
c	0.460	0.580	0.018	0.023
D	6.500	6.700	0.256	0.264
D1	5.100	5.460	0.201	0.215
D2	0.483 TYP.		0.190 TYP.	
E	6.000	6.200	0.236	0.244
e	2.186	2.386	0.086	0.094
L	9.800	10.400	0.386	0.409
L1	2.900 TYP.		0.114 TYP.	
L2	1.400	1.700	0.055	0.067
L3	1.600 TYP.		0.063 TYP.	
L4	0.600	1.000	0.024	0.039
Φ	1.100	1.300	0.043	0.051
θ	0°	8°	0°	8°
h	0.000	0.300	0.000	0.012
V	5.350 TYP.		0.211 TYP.	

X-ON Electronics

Largest Supplier of Electrical and Electronic Components

Click to view similar products for [MOSFET](#) category:

Click to view products by [SINO-IC](#) manufacturer:

Other Similar products are found below :

[614233C](#) [648584F](#) [IRFD120](#) [IRFF430](#) [JANTX2N5237](#) [2N7000](#) [FCA20N60_F109](#) [FDZ595PZ](#) [AOD464](#) [2SK2267\(Q\)](#) [2SK2545\(Q,T\)](#)
[405094E](#) [423220D](#) [MIC4420CM-TR](#) [VN1206L](#) [614234A](#) [715780A](#) [SSM6J414TU,LF\(T](#) [751625C](#) [PSMN4R2-30MLD](#)
[TK31J60W5,S1VQ\(O](#) [2SK2614\(TE16L1,Q\)](#) [DMN1017UCP3-7](#) [EFC2J004NUZTDG](#) [FCAB21350L1](#) [P85W28HP2F-7071](#) [DMN1053UCP4-7](#)
[NTE2384](#) [NTE2969](#) [NTE6400A](#) [DMN2080UCB4-7](#) [DMN61D9UWQ-13](#) [US6M2GTR](#) [DMN31D5UDJ-7](#) [SSM6P54TU,LF](#) [DMP22D4UFO-](#)
[7B](#) [IPS60R3K4CEAKMA1](#) [DMN1006UCA6-7](#) [DMN16M9UCA6-7](#) [STF5N65M6](#) [STU5N65M6](#) [C3M0021120D](#) [DMN13M9UCA6-7](#)
[BSS340NWH6327XTSA1](#) [MCM3400A-TP](#) [DMTH10H4M6SPS-13](#) [IRF40SC240ARMA1](#) [IPS60R1K0PFD7SAKMA1](#)
[IPS60R360PFD7SAKMA1](#) [IPS60R600PFD7SAKMA1](#)