

SE2333

P-Channel Enhancement-Mode MOSFET

Revision: A

General Description

Advanced trench technology to provide excellent RDS(ON), low gate charge and low operation voltage. This device is suitable for using as a load switch or in PWM applications.

- Simple Drive Requirement
- Small Package Outline
- Surface Mount Device

Features

For a single MOSFET

- $V_{DS} = -20V$
- $R_{DS(ON)} = 20m\Omega @ V_{GS} = -4.5V$

Pin configurations

See Diagram below



SOT-23-3

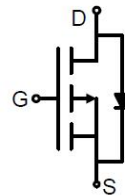

Absolute Maximum Ratings

Parameter		Symbol	Rating	Units
Drain-Source Voltage		V_{DS}	-20	V
Gate-Source Voltage		V_{GS}	± 12	V
Drain Current	Continuous	I_D	-6	A
	Pulsed		-20	
Total Power Dissipation	@TA=25°C	P_D	1.8	W
Operating Junction Temperature Range		T_J	-55 to 150	°C

Electrical Characteristics (T _J =25°C unless otherwise noted)						
Symbol	Parameter	Test Conditions	Min	Typ	Max	Units
OFF CHARACTERISTICS (Note 2)						
B _V DSS	Drain-Source Breakdown Voltage	I _D =-250μA, V _{GS} =0V	-20			V
I _{DSS}	Drain to Source Leakage Current	V _{DS} =-20V, V _{GS} =0V			-1	μA
I _{GSS}	Gate-Body Leakage Current	V _{GS} =12V			100	nA
V _{GS(th)}	Gate Threshold Voltage	V _{DS} = V _{GS} , I _D =-250μA	-0.4	-0.65	-1.0	V
R _{DS(on)}	Static Drain-Source On-Resistance	V _{GS} =-4.5V, I _D =-6A		20	30	mΩ
		V _{GS} =-2.5V, I _D =-5A		26	45	mΩ
g _{FS}	Forward Transconductance	V _{DS} =-5V, I _D =-6A		17		S
DYNAMIC PARAMETERS						
C _{iss}	Input Capacitance	V _{GS} =0V, V _{DS} =-6V, f=1MHz		1100		pF
C _{oss}	Output Capacitance			390		pF
C _{rss}	Reverse Transfer Capacitance			300		pF
SWITCHING PARAMETERS						
Q _g	Total Gate Charge ²	V _{GS} =-4.5V, V _{DS} =-6V, I _D =-6A		11.5		nC
Q _{gs}	Gate Source Charge			1.5		nC
Q _{gd}	Gate Drain Charge			3.2		nC
t _{d(on)}	Turn-On Delay Time	V _{GS} =-4.5V, V _{DS} =-6V, R _{GEN} =6Ω, R _L =6Ω		25		ns
t _{d(off)}	Turn-Off Delay Time			72		ns
t _{d(r)}	Turn-On Rise Time			45		ns
t _{d(f)}	Turn-Off Fall Time			60		ns

Test Circuits and Waveform

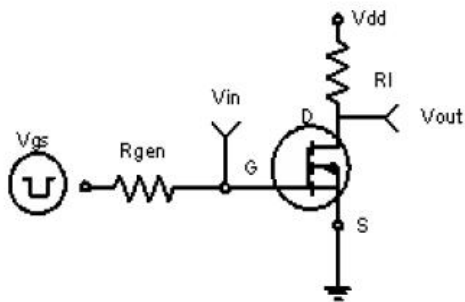

Figure 1: Switching Test Circuit

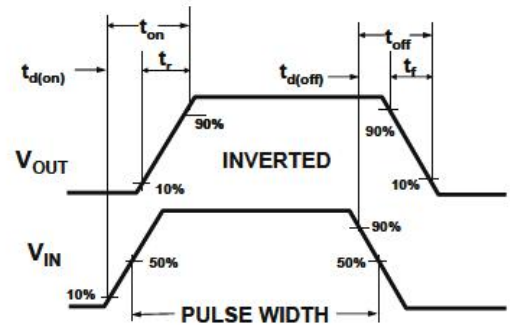

Figure 2: Switching Waveforms

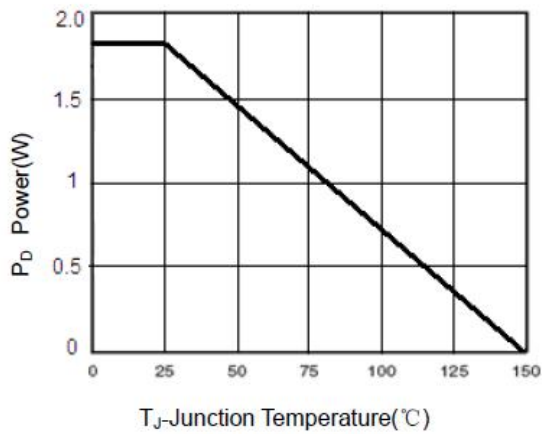

Figure 3 Power Dissipation

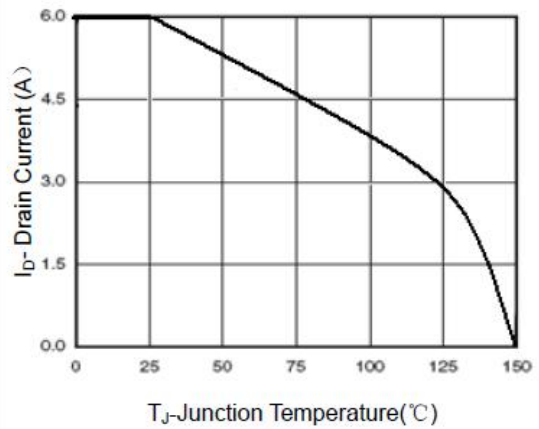

Figure 4 Drain Current

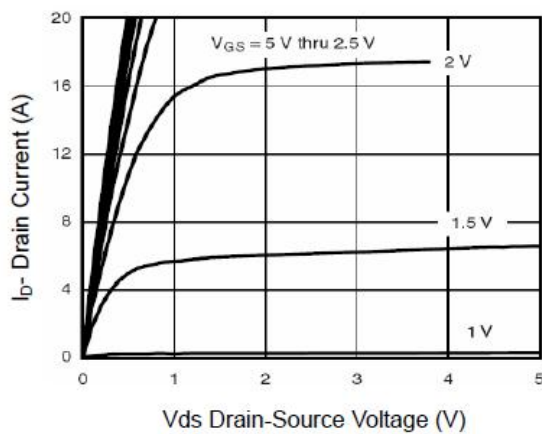

Figure 5 Output Characteristics

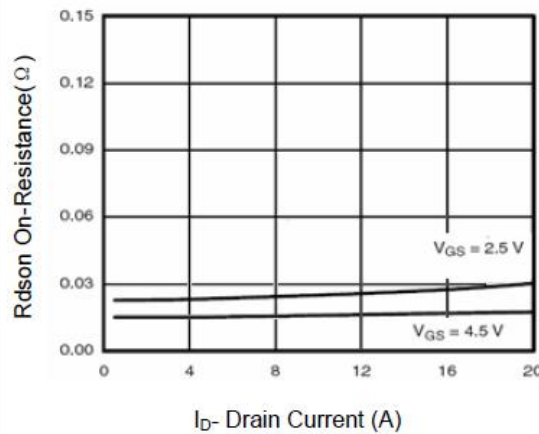

Figure 6 Drain-Source On-Resistance

Typical Characteristics

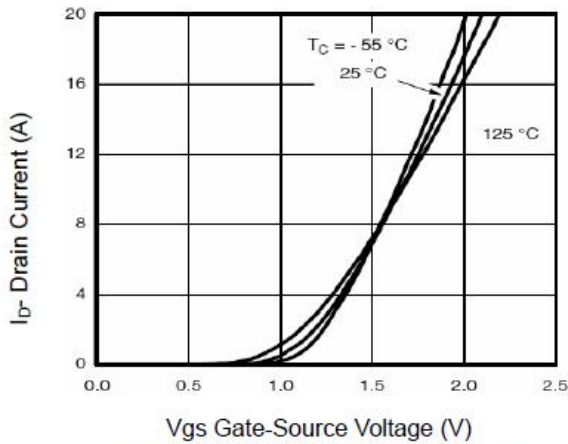

Figure 7 Transfer Characteristics

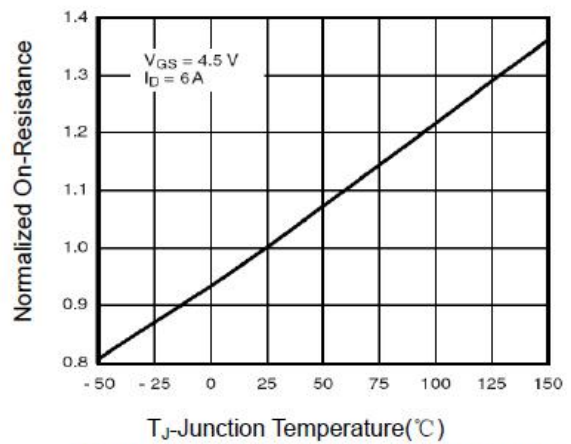

Figure 8 Drain-Source On-Resistance

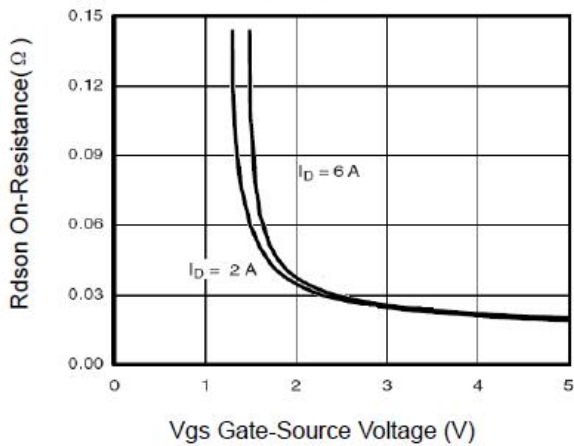

Figure 9 $R_{DS(on)}$ vs V_{GS}

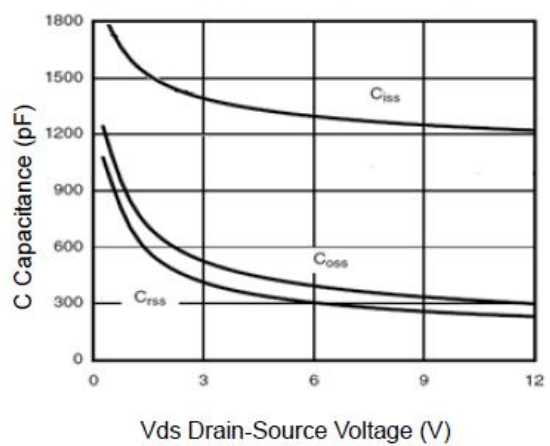

Figure 10 Capacitance vs V_{DS}

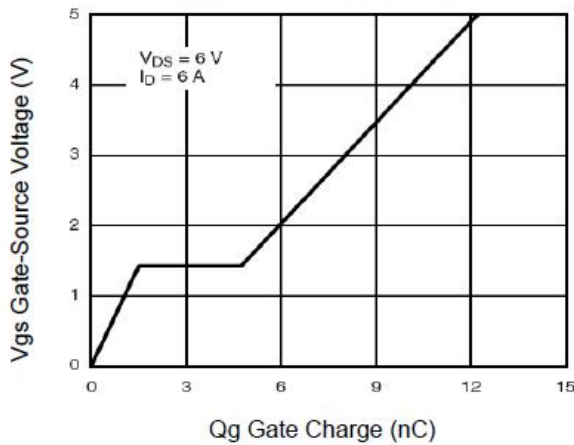

Figure 11 Gate Charge

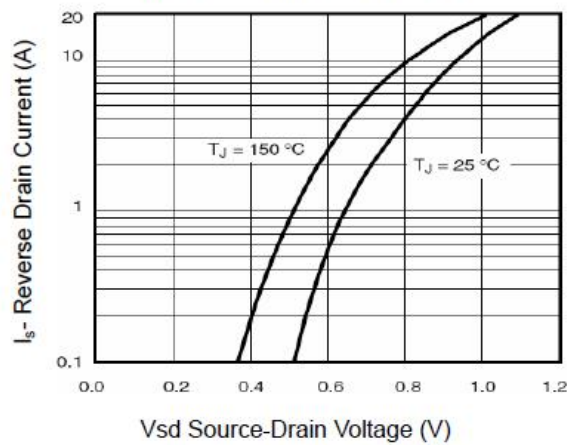

Figure 12 Source-Drain Diode Forward

Typical Characteristics

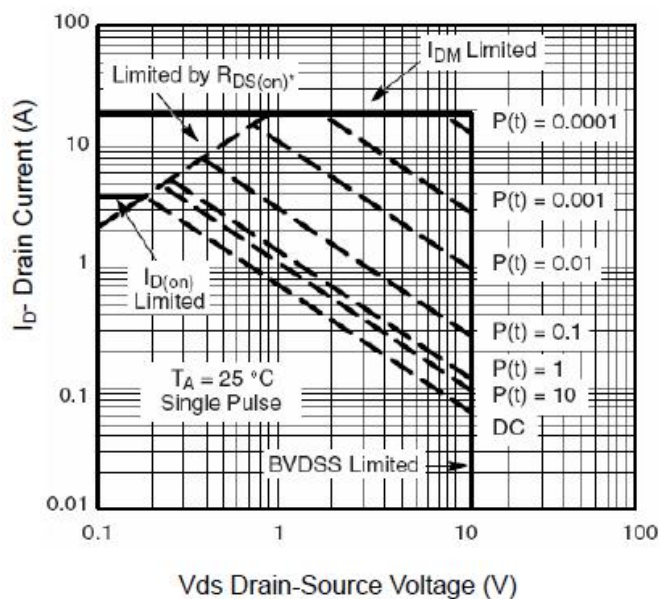

Figure 13 Safe Operation Area

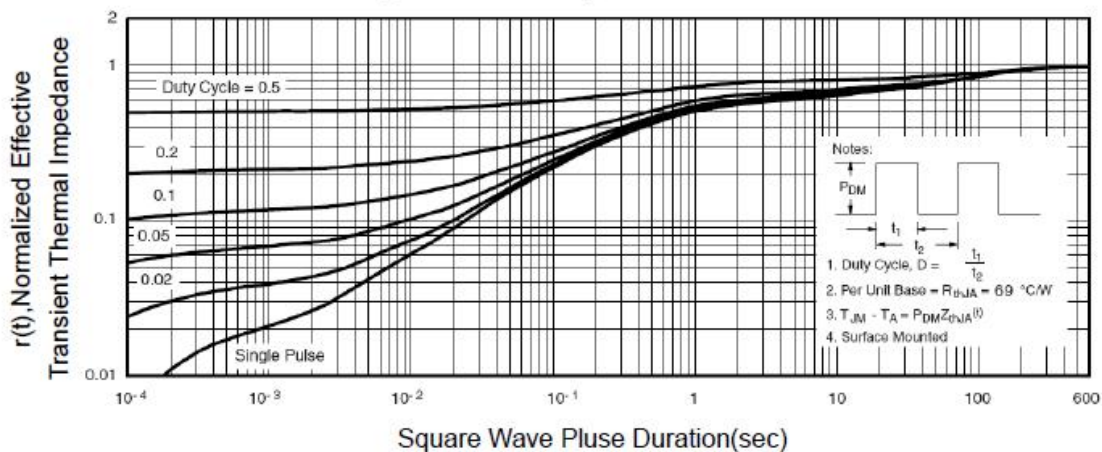
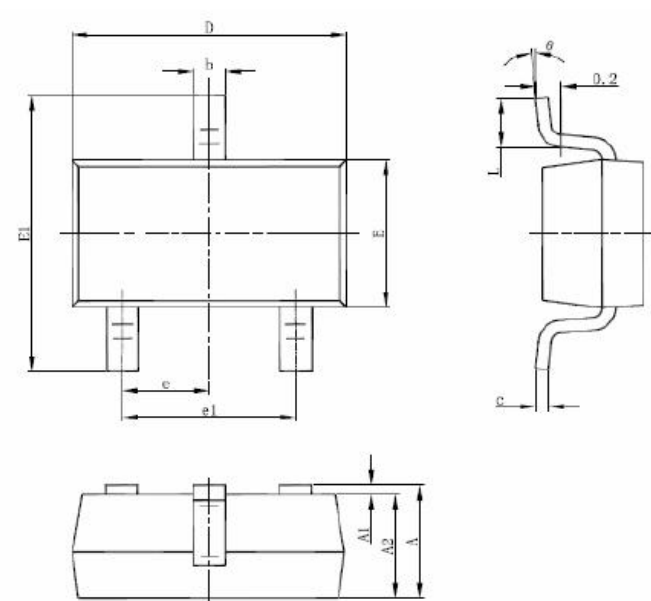

Figure 14 Normalized Maximum Transient Thermal Impedance

SE2333

Package Outline Dimension

SOT-23-3



Symbol	Dimensions In Millimeters		Dimensions In Inches	
	Min	Max	Min	Max
A	1.050	1.250	0.041	0.049
A1	0.000	0.100	0.000	0.004
A2	1.050	1.150	0.041	0.045
b	0.300	0.500	0.012	0.020
c	0.100	0.200	0.004	0.008
D	2.820	3.020	0.111	0.119
E	1.500	1.700	0.059	0.067
E1	2.650	2.950	0.104	0.116
e	0.950(BSC)		0.037(BSC)	
e1	1.800	2.000	0.071	0.079
L	0.300	0.600	0.012	0.024
θ	0°	8°	0°	8°

**The SINO-IC logo is a registered trademark of ShangHai Sino-IC Microelectronics Co., Ltd.
© 2005 SINO-IC – Printed in China – All rights reserved.**

SHANGHAI SINO-IC MICROELECTRONICS CO., LTD

Add: Building 3, Room 3401-03, No.200 Zhangheng Road, ZhangJiang Hi-Tech Park, Pudong,
Shanghai 201203, China

Phone: +86-21-33932402 33932403 33932405 33933508 33933608

Fax: +86-21-33932401

Email: webmaster@sino-ic.net

Website: <http://www.sino-ic.net>

X-ON Electronics

Largest Supplier of Electrical and Electronic Components

Click to view similar products for [MOSFET](#) category:

Click to view products by [SINO-IC](#) manufacturer:

Other Similar products are found below :

[614233C](#) [648584F](#) [MCH3443-TL-E](#) [MCH6422-TL-E](#) [FDPF9N50NZ](#) [FW216A-TL-2W](#) [FW231A-TL-E](#) [APT5010JVR](#) [NTNS3A92PZT5G](#)
[IRF100S201](#) [JANTX2N5237](#) [2SK2464-TL-E](#) [2SK3818-DL-E](#) [FCA20N60_F109](#) [FDZ595PZ](#) [STD6600NT4G](#) [FSS804-TL-E](#) [2SJ277-DL-E](#)
[2SK1691-DL-E](#) [2SK2545\(Q,T\)](#) [D2294UK](#) [405094E](#) [423220D](#) [MCH6646-TL-E](#) [TPCC8103,L1Q\(CM](#) [367-8430-0972-503](#) [VN1206L](#)
[424134F](#) [026935X](#) [051075F](#) [SBVS138LT1G](#) [614234A](#) [715780A](#) [NTNS3166NZT5G](#) [751625C](#) [873612G](#) [IRF7380TRHR](#)
[IPS70R2K0CEAKMA1](#) [RJK60S3DPP-E0#T2](#) [RJK60S5DPK-M0#T0](#) [APT5010JVFR](#) [APT12031JFLL](#) [APT12040JVR](#) [DMN3404LQ-7](#)
[NTE6400](#) [JANTX2N6796U](#) [JANTX2N6784U](#) [JANTXV2N5416U4](#) [SQM110N05-06L-GE3](#) [SIHF35N60E-GE3](#)