

SE3080A/K

N-Channel Enhancement-Mode MOSFET

Revision: A

General Description

Advanced trench technology to provide excellent RDS(ON), low gate charge and low operation voltage. This device is suitable for using as a load switch or in PWM applications.

- Simple Drive Requirement
- Small Package Outline
- Surface Mount Device

Features

For a single MOSFET

- $V_{DS} = 30V$
- $R_{DS(ON)} = 4.5m\Omega @ V_{GS}=10V(SE3080A)$
- $R_{DS(ON)} = 4.5m\Omega @ V_{GS}=10V(SE3080K)$

Pin configurations

See Diagram below

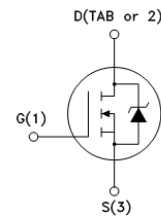
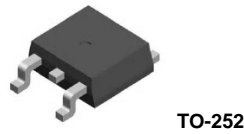
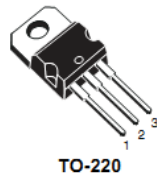

Absolute Maximum Ratings

Parameter		Symbol	Rating	Units
Drain-Source Voltage		V_{DS}	30	V
Gate-Source Voltage		V_{GS}	± 20	V
Drain Current	Continuous	I_D	80	A
	Pulsed		170	
Total Power Dissipation	@TA=25°C	P_D	83	W
Derating factor			0.56	W/°C
Single pulse avalanche energy		E_{AS}	285	mJ
Operating Junction Temperature Range		T_J	-55 to 175	°C

Thermal Resistance

Symbol	Parameter	Typ	Max	Units
$R_{\theta JC}$	Thermal Resistance Junction to Case	-	1.8	°C/W

SE3080A/K

Electrical Characteristics (T _J =25°C unless otherwise noted)						
Symbol	Parameter	Test Conditions	Min	Typ	Max	Units
OFF CHARACTERISTICS (Note 2)						
BV _{DSS}	Drain-Source Breakdown Voltage	I _D =250μA, V _{GS} =0 V	30			V
I _{DSS}	Drain to Source Leakage Current	V _{DS} = 30V, V _{GS} =0V			1	μA
I _{GSS}	Gate-Body Leakage Current	V _{GS} =20V			100	nA
V _{GS(th)}	Gate Threshold Voltage	V _{DS} = V _{GS} , I _D =250μA	1	1.6	3	V
R _{DS(ON)} SE3080A	Static Drain-Source On-Resistance	V _{GS} =10V, I _D =30A	-	4.5	6.5	mΩ
		V _{GS} =4.5V, I _D =24A	-	7	9.5	mΩ
R _{DS(ON)} SE3080K	Static Drain-Source On-Resistance	V _{GS} =10V, I _D =30A	-	4.5	6.5	mΩ
		V _{GS} =4.5V, I _D =24A	-	7.5	10	mΩ
DYNAMIC PARAMETERS						
C _{iss}	Input Capacitance	V _{GS} =0V, V _{DS} =15V, f=1MHz		2330		pF
C _{oss}	Output Capacitance			460		pF
C _{rss}	Reverse Transfer Capacitance			230		pF
SWITCHING PARAMETERS						
Q _g	Total Gate Charge ²	V _{GS} =10V, V _{DS} =30V, I _D =30A		51		nC
Q _{gs}	Gate Source Charge			14		nC
Q _{gd}	Gate Drain Charge			11		nC
t _{d(on)}	Turn-On Delay Time	V _{GS} =10V, V _{DS} =10V, R _{GEN} =2.7Ω I _D =30A		20		ns
t _{d(off)}	Turn-Off Delay Time			60		ns
t _{d(r)}	Turn-On Rise Time			15		ns
t _{d(f)}	Turn-Off Fall Time			10		ns

Typical Characteristics

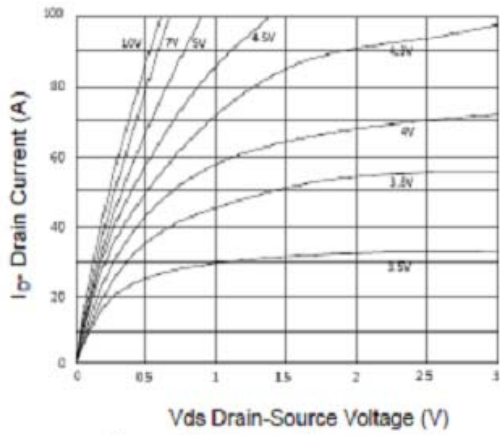

Figure 1 Output Characteristics

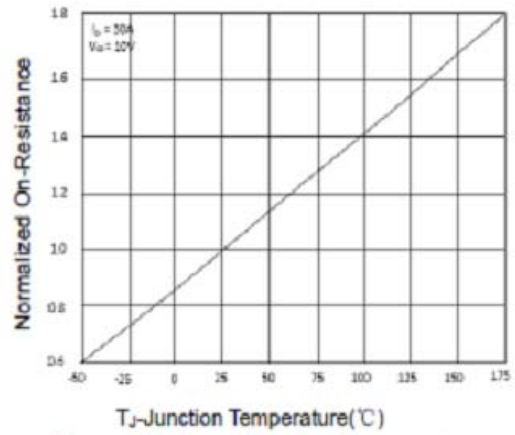

Figure 4 Rds(on)-Junction Temperature

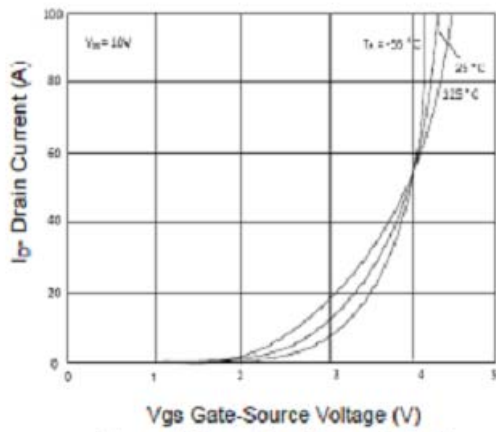

Figure 2 Transfer Characteristics

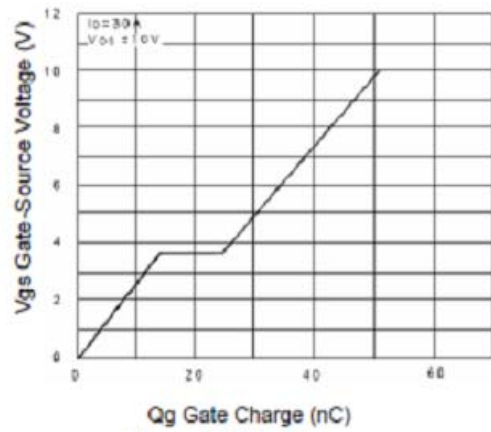

Figure 5 Gate Charge

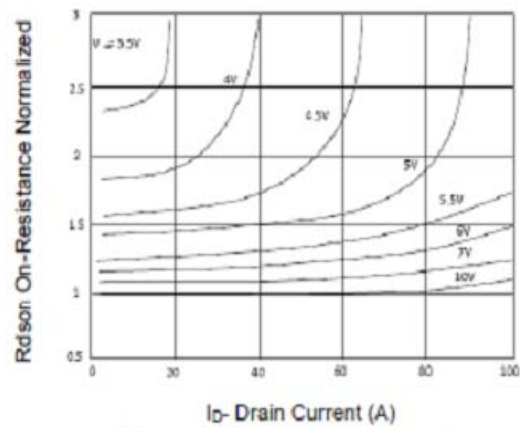

Figure 3 Rds(on)-Drain Current

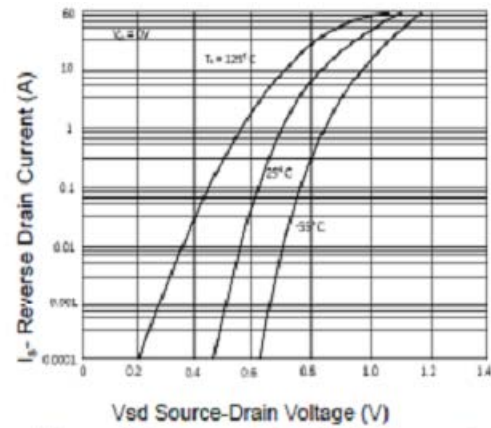

Figure 6 Source-Drain Diode Forward

Typical Characteristics

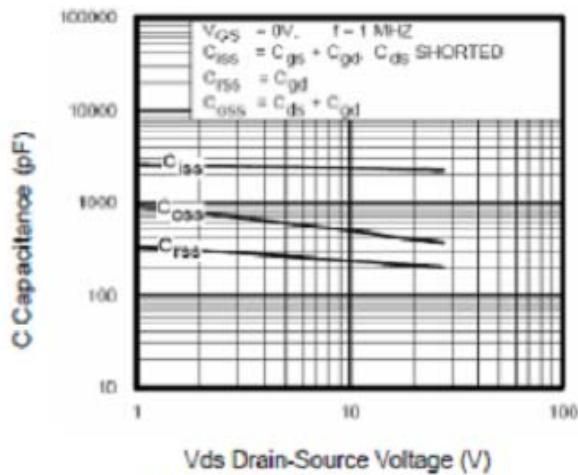

Figure 7 Capacitance vs Vds

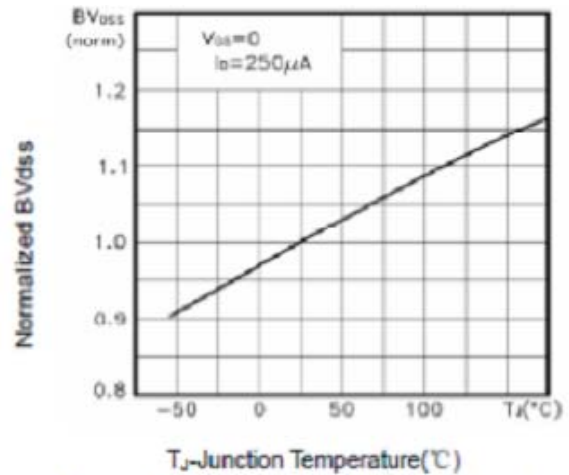

Figure 9 BVoss vs Junction Temperature

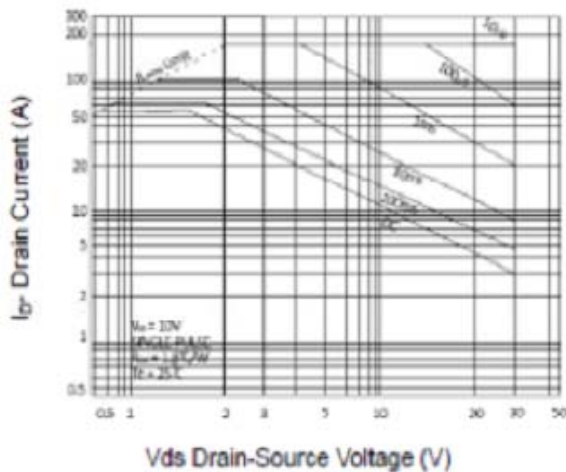

Figure 8 Safe Operation Area

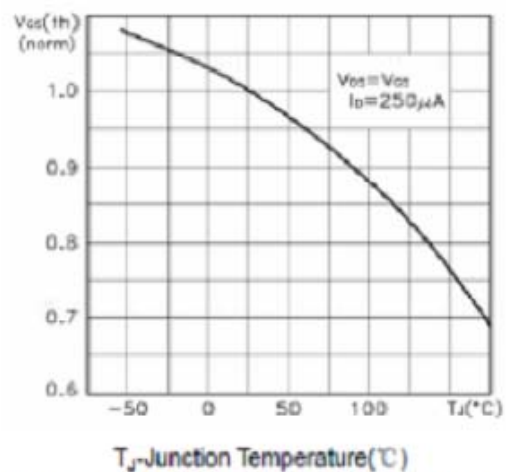

Figure 10 VGS(th) vs Junction Temperature

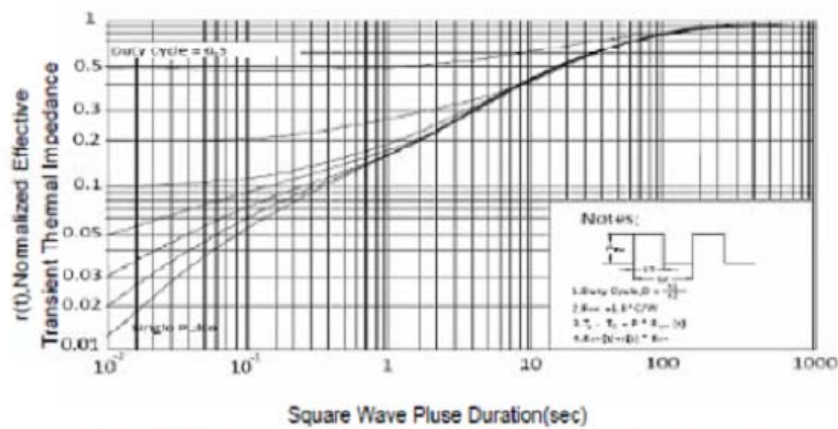
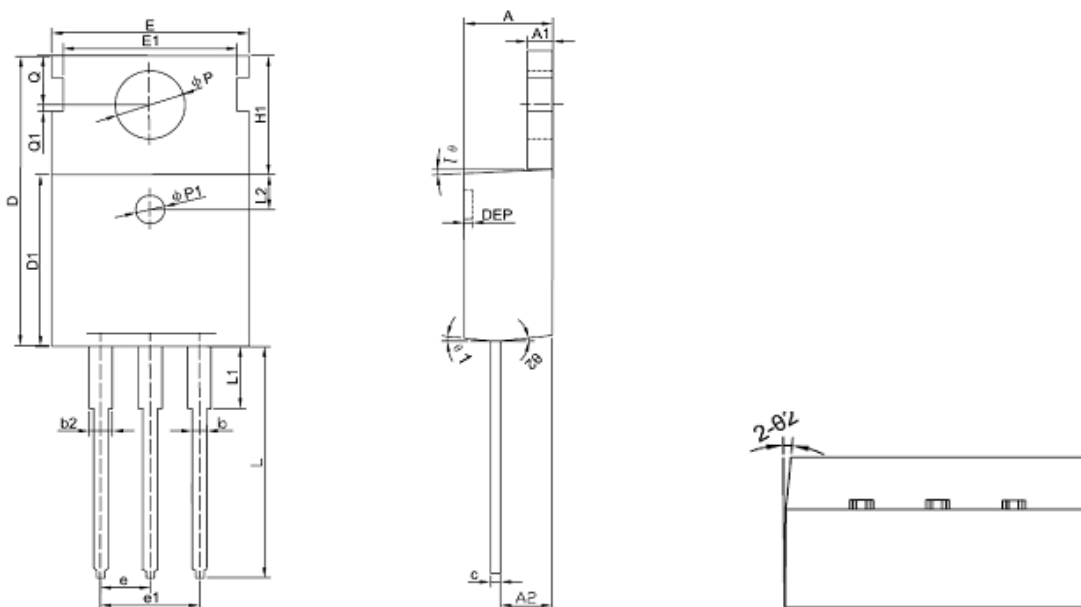

Figure 11 Normalized Maximum Transient Thermal Impedance

SE3080A/K

Package Outline Dimension

TO-220



Symbol	Dimension In Millimeters			Dimension In Inches		
	Min	Nom	Max	Min	Nom	Max
A	4.400	4.550	4.700	0.173	0.179	0.185
A1	1.270	1.300	1.330	0.050	0.051	0.052
A2	2.590	2.690	2.790	0.102	0.106	0.110
b	0.770	-	0.900	0.030	-	0.035
b2	1.230	-	1.360	0.048	-	0.054
c	0.480	0.500	0.520	0.019	0.020	0.020
D	15.100	15.400	15.700	-	0.606	-
D1	9.000	9.100	9.200	0.354	0.358	0.362
DEP	0.050	0.285	0.520	0.002	0.011	0.020
E	10.060	10.160	10.260	0.396	0.400	0.404
E1	-	8.700	-	-	0.343	-
$\Phi P1$	1.400	1.500	1.600	0.055	0.059	0.063
e	2.54BSC			0.1BSC		
e1	5.08BSC			0.2BSC		
H1	6.100	6.300	6.500	0.240	0.248	0.256
L	12.750	12.960	13.170	0.502	0.510	0.519
L1	-	-	3.950	-	-	0.156
L2	1.85REF			0.073REF		
ΦP	3.570	3.600	3.630	0.141	0.142	0.143
Q	2.730	2.800	2.870	0.107	0.110	0.113
Q1	-	0.200	-	-	0.008	-
$\Theta 1$	5 ⁰	7 ⁰	9 ⁰	5 ⁰	7 ⁰	9 ⁰
$\Theta 2$	1 ⁰	3 ⁰	5 ⁰	1 ⁰	3 ⁰	5 ⁰

TO-252

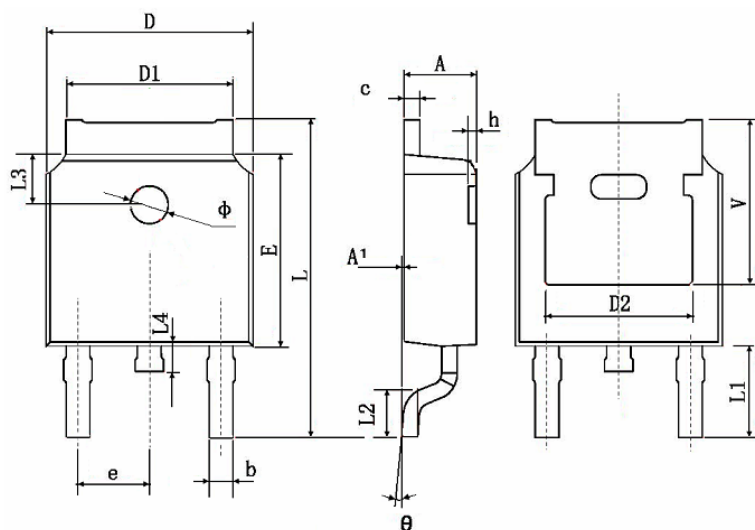

Symbol	Dimensions In Millimeters		Dimensions In Inches	
	Min.	Max.	Min.	Max.
A	2.200	2.400	0.087	0.094
A1	0.000	0.127	0.000	0.005
b	0.660	0.860	0.026	0.034
c	0.460	0.580	0.018	0.023
D	6.500	6.700	0.256	0.264
D1	5.100	5.460	0.201	0.215
D2	0.483 TYP.		0.190 TYP.	
E	6.000	6.200	0.236	0.244
e	2.186	2.386	0.086	0.094
L	9.800	10.400	0.386	0.409
L1	2.900 TYP.		0.114 TYP.	
L2	1.400	1.700	0.055	0.067
L3	1.600 TYP.		0.063 TYP.	
L4	0.600	1.000	0.024	0.039
phi	1.100	1.300	0.043	0.051
theta	0°	8°	0°	8°
h	0.000	0.300	0.000	0.012
V	5.350 TYP.		0.211 TYP.	

The SINO-IC logo is a registered trademark of ShangHai Sino-IC Microelectronics Co., Ltd.

© 2005 SINO-IC – Printed in China – All rights reserved.

SHANGHAI SINO-IC MICROELECTRONICS CO., LTD

Add: Building 3, Room 3401-03, No.200 Zhangheng Road, ZhangJiang Hi-Tech Park, Pudong, Shanghai 201203, China

Phone: +86-21-33932402 33932403 33932405 33933508 33933608

Fax: +86-21-33932401

Email: webmaster@sino-ic.net

Website: <http://www.sino-ic.net>

X-ON Electronics

Largest Supplier of Electrical and Electronic Components

Click to view similar products for [MOSFET](#) category:

Click to view products by [SINO-IC](#) manufacturer:

Other Similar products are found below :

[614233C](#) [648584F](#) [FDPF9N50NZ](#) [IRFD120](#) [IRFF430](#) [JANTX2N5237](#) [2N7000](#) [FCA20N60_F109](#) [FDZ595PZ](#) [2SK2267\(Q\)](#) [2SK2545\(Q,T\)](#)
[405094E](#) [423220D](#) [MIC4420CM-TR](#) [VN1206L](#) [614234A](#) [715780A](#) [SSM6J414TU,LF\(T](#) [751625C](#) [PSMN4R2-30MLD](#)
[TK31J60W5,S1VQ\(O](#) [2SK2614\(TE16L1,Q\)](#) [DMN1017UCP3-7](#) [EFC2J004NUZTDG](#) [FCAB21350L1](#) [P85W28HP2F-7071](#) [DMN1053UCP4-7](#)
[NTE2384](#) [NTE2969](#) [NTE6400A](#) [DMN61D9UWQ-13](#) [US6M2GTR](#) [DMN31D5UDJ-7](#) [SSM6P54TU,LF](#) [DMP22D4UFO-7B](#)
[IPS60R3K4CEAKMA1](#) [DMN1006UCA6-7](#) [DMN16M9UCA6-7](#) [STF5N65M6](#) [STU5N65M6](#) [C3M0021120D](#) [DMN13M9UCA6-7](#)
[BSS340NWH6327XTSA1](#) [MCM3400A-TP](#) [DMTH10H4M6SPS-13](#) [IPS60R1K0PFD7SAKMA1](#) [IPS60R360PFD7SAKMA1](#)
[IPS60R600PFD7SAKMA1](#) [IPS60R210PFD7SAKMA1](#) [DMN2990UFB-7B](#)