

SE80100G

**N-Channel Enhancement-Mode MOSFET**

Revision: A

**General Description**

Thigh Density Cell Design For Ultra Low On-Resistance Fully Characterized Avalanche Voltage and Current Improved Shoot-Through FOM

- Simple Drive Requirement
- Small Package Outline
- Surface Mount Device

**Features**

For a single MOSFET

- $V_{DS} = 80V$
- $R_{DS(ON)} = 4.9m\Omega @ V_{GS}=10$

**Pin configurations**

See Diagram below



TO-263

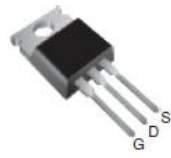

TO-220

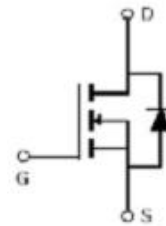

**Absolute Maximum Ratings**

Parameter		Symbol	Rating	Units
Drain-Source Voltage		$V_{DS}$	80	V
Gate-Source Voltage		$V_{GS}$	$\pm 20$	V
Drain Current	Continuous	$I_D$	100	A
	Pulsed		370	
Total Power Dissipation	@TA=25°C	$P_D$	125	W
Single Pulse Avalanche Energy		EAS	750	mJ
Operating Junction Temperature Range		$T_J$	-55 to 175	°C

# SE80100G

Electrical Characteristics (T <sub>J</sub> =25°C unless otherwise noted)						
Symbol	Parameter	Test Conditions	Min	Typ	Max	Units
<b>OFF CHARACTERISTICS (Note 2)</b>						
B <sub>V</sub> DSS	Drain-Source Breakdown Voltage	I <sub>D</sub> =250μA, V <sub>GS</sub> =0 V	80			V
I <sub>DSS</sub>	Drain to Source Leakage Current	V <sub>DS</sub> = 64V, V <sub>GS</sub> =0V			1	μA
I <sub>GSS</sub>	Gate-Body Leakage Current	V <sub>GS</sub> =20V			100	nA
V <sub>GS(th)</sub>	Gate Threshold Voltage	V <sub>DS</sub> = V <sub>GS</sub> , I <sub>D</sub> =250μA	1.5		2.5	V
R <sub>DS(ON)</sub>	Static Drain-Source On-Resistance <sup>2</sup>	V <sub>GS</sub> =10V, I <sub>D</sub> =40A	-	4.9	6.0	mΩ
<b>DYNAMIC PARAMETERS</b>						
C <sub>iss</sub>	Input Capacitance	V <sub>GS</sub> =0V, V <sub>DS</sub> =40V, f=1MHz		4120		pF
C <sub>oss</sub>	Output Capacitance			520		pF
C <sub>rss</sub>	Reverse Transfer Capacitance			200		pF
<b>SWITCHING PARAMETERS</b>						
Q <sub>g</sub>	Total Gate Charge	V <sub>GS</sub> =10V, V <sub>DS</sub> =64V, I <sub>D</sub> =40A		58		nC
Q <sub>gs</sub>	Gate Source Charge			15		nC
Q <sub>gd</sub>	Gate Drain Charge			19		nC
t <sub>d(on)</sub>	Turn-On Delay Time	V <sub>GS</sub> =10V, V <sub>DS</sub> =40V, R <sub>GEN</sub> =4.7Ω I <sub>D</sub> =2A		34		ns
t <sub>d(off)</sub>	Turn-Off Delay Time			103		ns
t <sub>d(r)</sub>	Turn-On Rise Time			95		ns
t <sub>d(f)</sub>	Turn-Off Fall Time			33		ns
<b>Thermal Resistance</b>						
Symbol	Parameter		Typ	Max		Units
R <sub>θJC</sub>	Thermal Resistance Junction to Case(t <sub>s</sub> ≤10s)		-	1.2		°C/W

Typical Characteristics

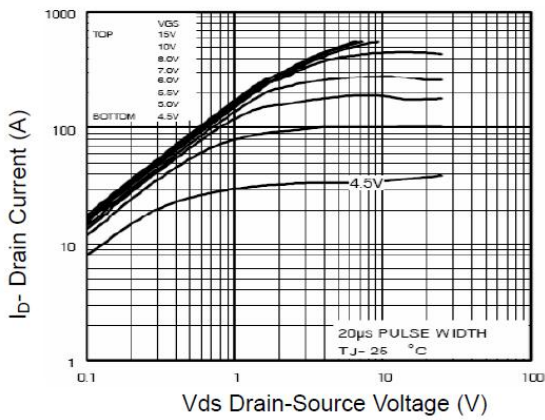

Figure 1 Output Characteristics

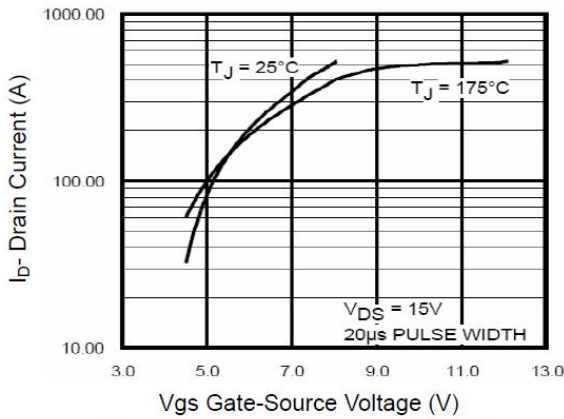

Figure 2 Transfer Characteristics

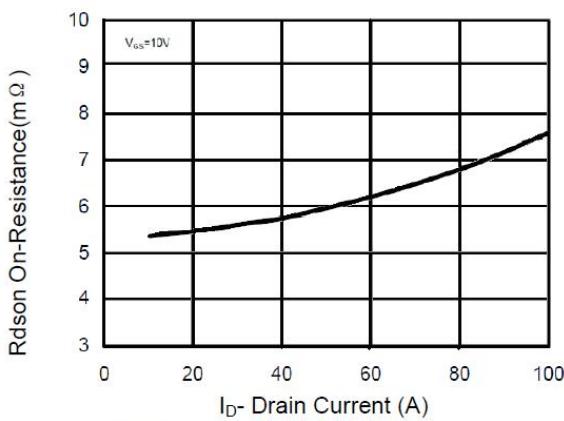

Figure 3 Rdson- Drain Current

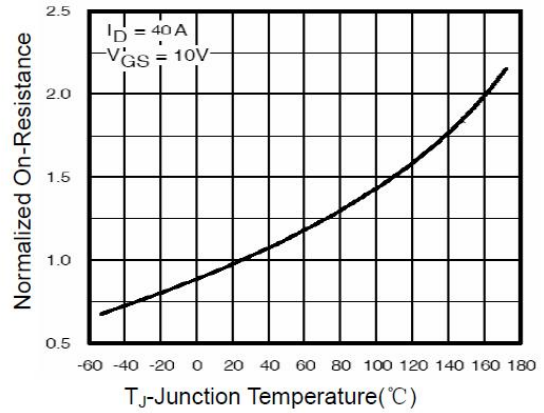

Figure 4 Rdson-Junction Temperature

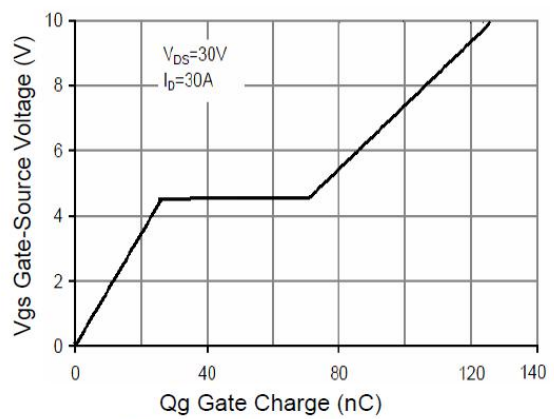

Figure 5 Gate Charge

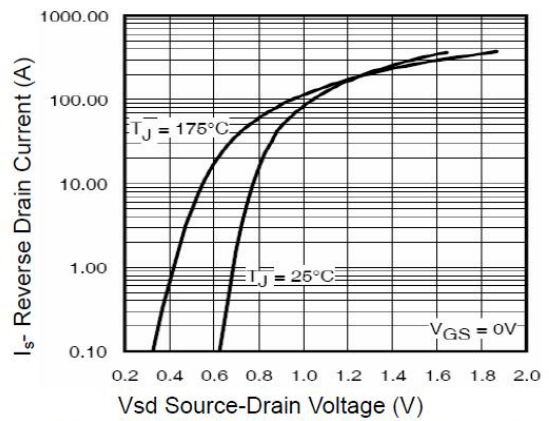

Figure 6 Source- Drain Diode Forward

Typical Characteristics

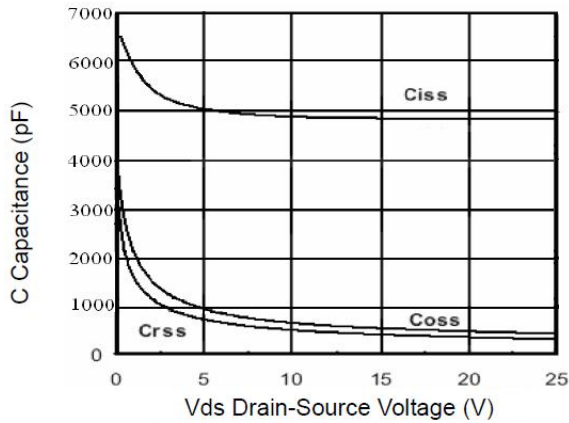

Figure 7 Capacitance vs Vds

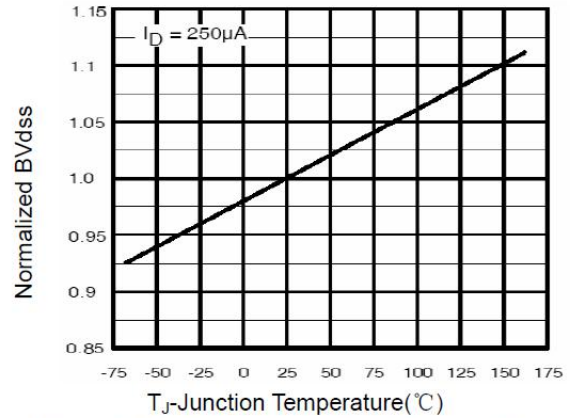

Figure 9  $BV_{DSS}$  vs Junction Temperature

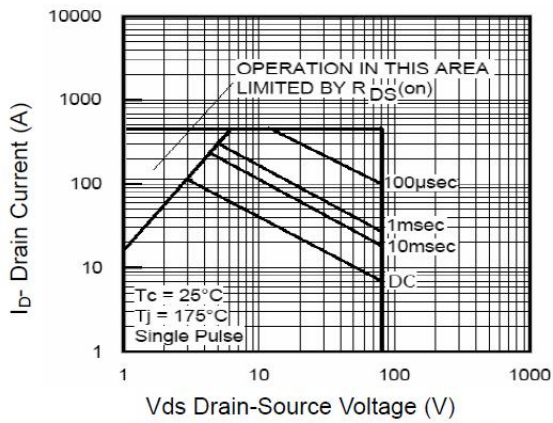

Figure 8 Safe Operation Area

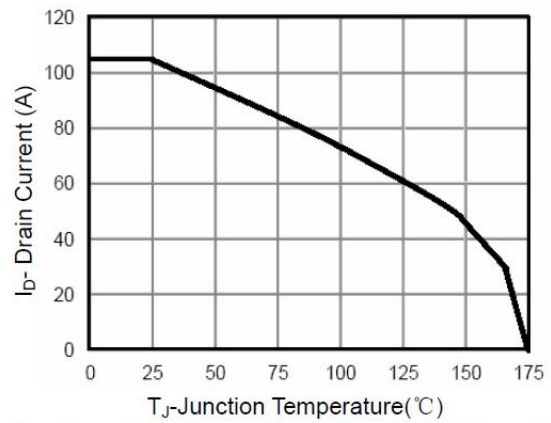

Figure 10 Current vs Junction Temperature

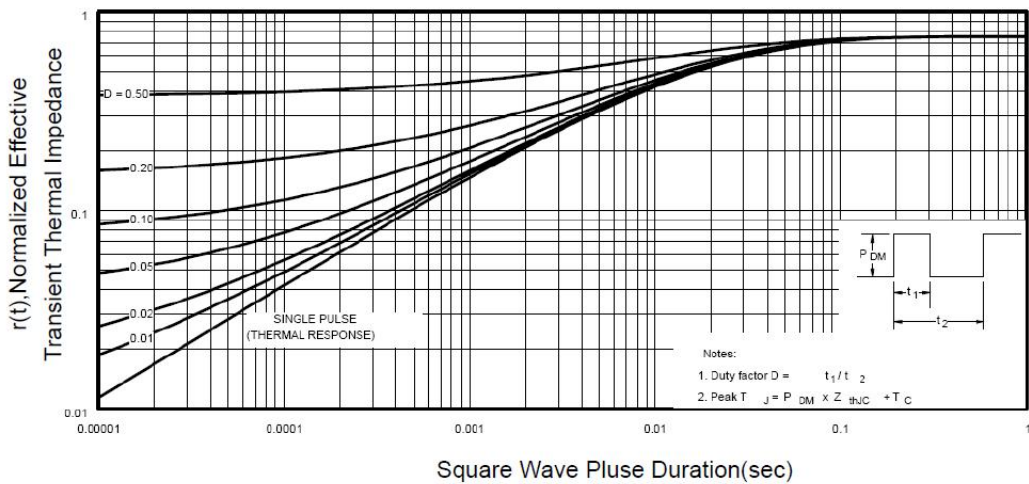
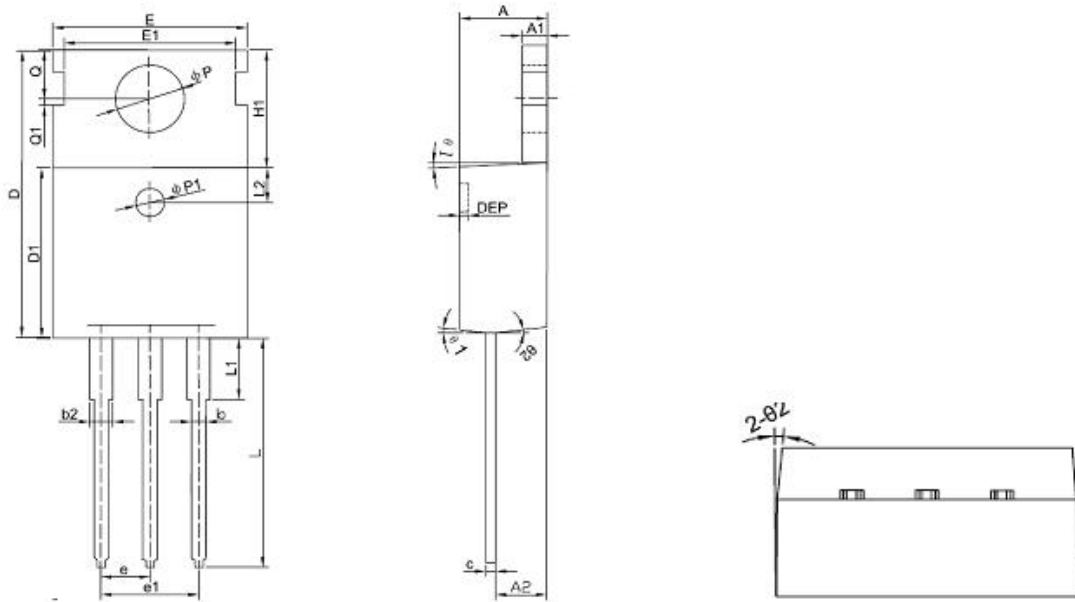

Figure 11 Normalized Maximum Transient Thermal Impedance

# SE80100G

## Package Outline Dimension

### TO-220



Symbol	Dimension In Millimeters			Dimension In Inches		
	Min	Nom	Max	Min	Nom	Max
A	4.400	4.550	4.700	0.173	0.179	0.185
A1	1.270	1.300	1.330	0.050	0.051	0.052
A2	2.590	2.690	2.790	0.102	0.106	0.110
b	0.770	-	0.900	0.030	-	0.035
b2	1.230	-	1.360	0.048	-	0.054
c	0.480	0.500	0.520	0.019	0.020	0.020
D	15.100	15.400	15.700	-	0.606	-
D1	9.000	9.100	9.200	0.354	0.358	0.362
DEP	0.050	0.285	0.520	0.002	0.011	0.020
E	10.060	10.160	10.260	0.396	0.400	0.404
E1	-	8.700	-	-	0.343	-
$\Phi P1$	1.400	1.500	1.600	0.055	0.059	0.063
e	2.54BSC			0.1BSC		
e1	5.08BSC			0.2BSC		
H1	6.100	6.300	6.500	0.240	0.248	0.256
L	12.750	12.960	13.170	0.502	0.510	0.519
L1	-	-	3.950	-	-	0.156
L2	1.85REF			0.073REF		
$\Phi P$	3.570	3.600	3.630	0.141	0.142	0.143
Q	2.730	2.800	2.870	0.107	0.110	0.113
Q1	-	0.200	-	-	0.008	-
$\theta 1$	5 <sup>0</sup>	7 <sup>0</sup>	9 <sup>0</sup>	5 <sup>0</sup>	7 <sup>0</sup>	9 <sup>0</sup>
$\theta 2$	1 <sup>0</sup>	3 <sup>0</sup>	5 <sup>0</sup>	1 <sup>0</sup>	3 <sup>0</sup>	5 <sup>0</sup>

TO-263

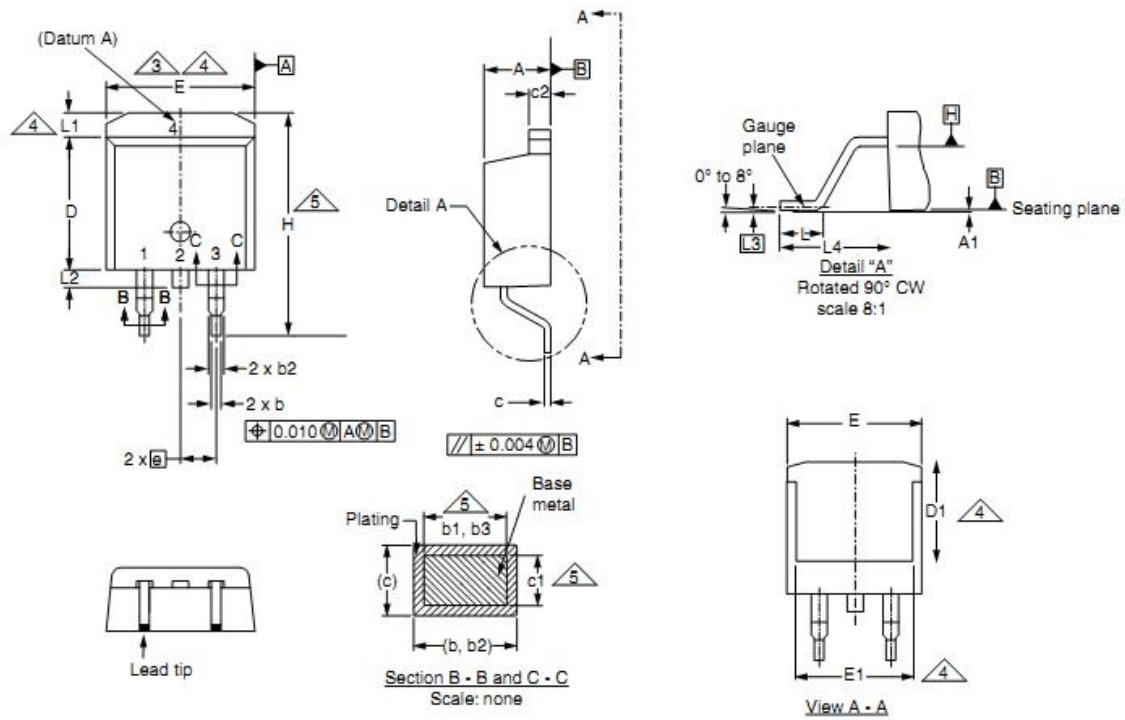

DIM.	MILLIMETERS		INCHES	
	MIN.	MAX.	MIN.	MAX.
A	4.06	4.83	0.160	0.190
A1	0.00	0.25	0.000	0.010
b	0.51	0.99	0.020	0.039
b1	0.51	0.89	0.020	0.035
b2	1.14	1.78	0.045	0.070
b3	1.14	1.73	0.045	0.068
c	0.38	0.74	0.015	0.029
c1	0.38	0.58	0.015	0.023
c2	1.14	1.65	0.045	0.065
D	8.38	9.65	0.330	0.380

DIM.	MILLIMETERS		INCHES	
	MIN.	MAX.	MIN.	MAX.
D1	6.86	-	0.270	-
E	9.65	10.67	0.380	0.420
E1	6.22	-	0.245	-
e	2.54 BSC		0.100 BSC	
H	14.61	15.88	0.575	0.625
L	1.78	2.79	0.070	0.110
L1	-	1.65	-	0.066
L2	-	1.78	-	0.070
L3	0.25 BSC		0.010 BSC	
L4	4.78	5.28	0.188	0.208

**The SINO-IC logo is a registered trademark of ShangHai Sino-IC Microelectronics Co., Ltd.**

**© 2005 SINO-IC – Printed in China – All rights reserved.**

**SHANGHAI SINO-IC MICROELECTRONICS CO., LTD**

**Add:** Building 3, Room 3401-03, No.200 Zhangheng Road, ZhangJiang Hi-Tech Park, Pudong,  
Shanghai 201203, China

**Phone:** +86-21-33932402 33932403 33932405 33933508 33933608

**Fax:** +86-21-33932401

**Email:** webmaster@sino-ic.net

**Website:** <http://www.sino-ic.net>

## X-ON Electronics

Largest Supplier of Electrical and Electronic Components

*Click to view similar products for [MOSFET](#) category:*

*Click to view products by [SINO-IC](#) manufacturer:*

Other Similar products are found below :

[614233C](#) [648584F](#) [IRFD120](#) [IRFF430](#) [JANTX2N5237](#) [2N7000](#) [FCA20N60\\_F109](#) [FDZ595PZ](#) [AOD464](#) [2SK2267\(Q\)](#) [2SK2545\(Q,T\)](#)  
[405094E](#) [423220D](#) [MIC4420CM-TR](#) [VN1206L](#) [614234A](#) [715780A](#) [SSM6J414TU,LF\(T](#) [751625C](#) [PSMN4R2-30MLD](#)  
[TK31J60W5,S1VQ\(O](#) [2SK2614\(TE16L1,Q\)](#) [DMN1017UCP3-7](#) [EFC2J004NUZTDG](#) [FCAB21350L1](#) [P85W28HP2F-7071](#) [DMN1053UCP4-7](#)  
[NTE2384](#) [NTE2969](#) [NTE6400A](#) [DMN2080UCB4-7](#) [DMN61D9UWQ-13](#) [US6M2GTR](#) [DMN31D5UDJ-7](#) [SSM6P54TU,LF](#) [DMP22D4UFO-](#)  
[7B](#) [IPS60R3K4CEAKMA1](#) [DMN1006UCA6-7](#) [DMN16M9UCA6-7](#) [STF5N65M6](#) [STU5N65M6](#) [C3M0021120D](#) [DMN13M9UCA6-7](#)  
[BSS340NWH6327XTSA1](#) [MCM3400A-TP](#) [DMTH10H4M6SPS-13](#) [IRF40SC240ARMA1](#) [IPS60R1K0PFD7SAKMA1](#)  
[IPS60R360PFD7SAKMA1](#) [IPS60R600PFD7SAKMA1](#)