

SE8N65A

N-Channel Enhancement-Mode MOSFET

Revision: A

General Description

This type used advanced trench technology and design to provide excellent RDS(ON) with low gate charge. It can be used in a wide variety of application

Features

For a single MOSFET

- $V_{DS} = 650V$
- $R_{DS(ON)} = 1.085\Omega @ V_{GS}=10V$

Pin configurations

See Diagram below

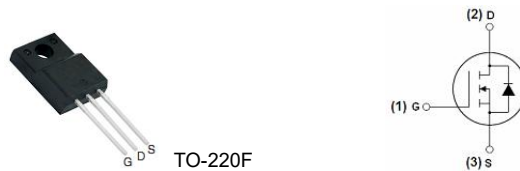

Absolute Maximum Ratings

Parameter		Symbol	Rating	Units
Drain-Source Voltage		V_{DS}	650	V
Gate-Source Voltage		V_{GS}	± 30	V
Avalanche Current ²		I_{AR}	7.5	A
Drain Current	Continuous	I_D	8.0	A
	Pulsed		28	
Avalanche Energy Single Pulsed ³		E_{AS}	420	mJ
Power Dissipation		P_D	48	W
Operating Junction Temperature Range		T_J	-55 to 150	$^{\circ}C$

Thermal Resistance

Symbol	Parameter	Typ.	Max.	Units
$R_{\theta JA}$	Junction to Ambient		62.5	$^{\circ}C/W$

SE8N65A

Electrical Characteristics (T _J =25°C unless otherwise noted)						
Symbol	Parameter	Test Conditions	Min	Typ	Max	Units
OFF CHARACTERISTICS (Note 2)						
B _V DSS	Drain-Source Breakdown Voltage	V _{GS} =0V, I _D =250μA,	650			V
I _{DSS}	Drain to Source Leakage Current	V _{DS} =650V, V _{GS} =0V			10	μA
I _{GSS}	Gate-Body Leakage Current	V _{GS} =30V			100	nA
V _{GS(th)}	Gate Threshold Voltage	V _{DS} = V _{GS} , I _D =250μA	2		4	V
R _{DS(ON)}	Static Drain-Source On-Resistance	V _{GS} =10V, I _D =2.1A		1.085	1.30	Ω
DYNAMIC PARAMETERS						
C _{iss}	Input Capacitance	V _{GS} =0V, V _{DS} =25V, f=1MHz		1100	1430	pF
C _{oss}	Output Capacitance			135	175	pF
C _{rss}	Reverse Transfer Capacitance			16	21	pF
SWITCHING PARAMETERS						
Q _g	Total Gate Charge ²	V _{GS} =10V, V _{DS} =480V, I _D =7A		29	38	nC
Q _{gs}	Gate Source Charge			7		nC
Q _{gd}	Gate Drain Charge			14.5		nC
t _{d(on)}	Turn-On Delay Time	V _{DS} =325V, R _{GEN} =25Ω I _D =7A		30	70	ns
t _{d(off)}	Turn-Off Delay Time			80	170	ns
t _{d(r)}	Turn-On Rise Time			65	140	ns
t _{d(f)}	Turn-Off Fall Time			60	130	ns
Source-Drain Diode Characteristics						
V _{SD}	Drain-Source Diode Forward Voltage	V _{GS} =0V, I _S =7A			1.5	V
I _S	Max Drain-Source Diode Current				7.5	A
I _{SM}	Max Pulse Drain-Source Current				28	A
t _{rr}	Reverse Recovery Time	V _{GS} =0V, I _S =7A		320		ns
Q _{RR}	Reverse Recovery Charge	dI _F /dt=100A/μs ¹		2.4		μC

Typical Characteristics

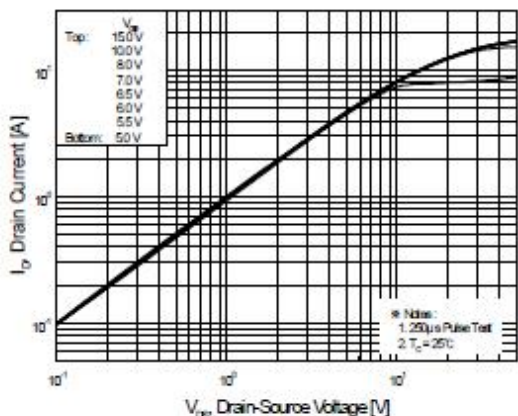

Figure 1. On-Region Characteristics

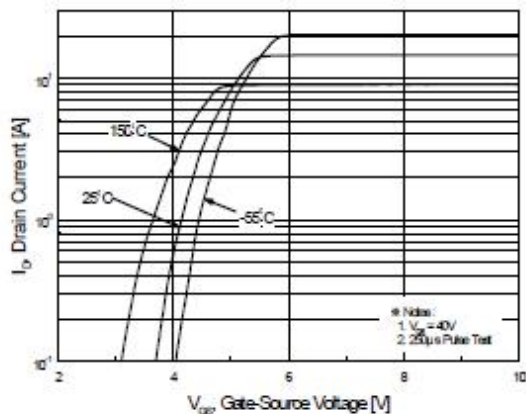

Figure 2. Transfer Characteristics

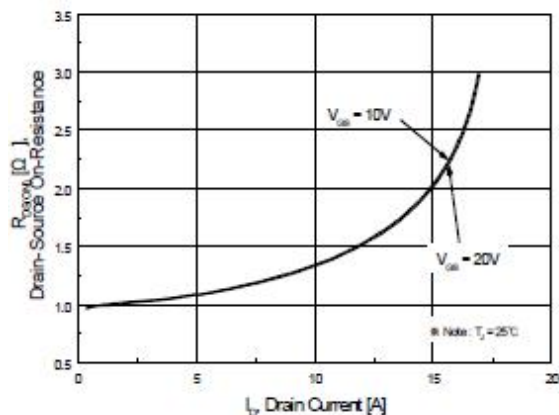

Figure 3. On-Resistance Variation vs Drain Current and Gate Voltage

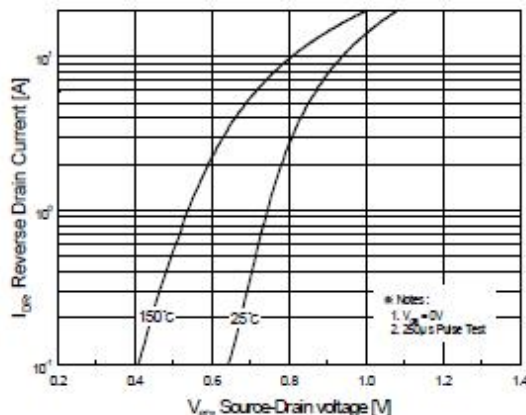

Figure 4. Body Diode Forward Voltage Variation with Source Current and Temperature

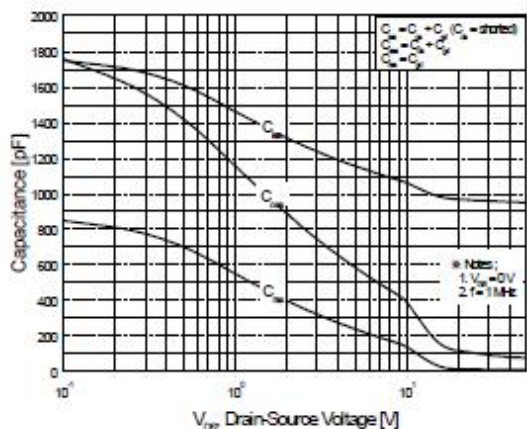

Figure 5. Capacitance Characteristics

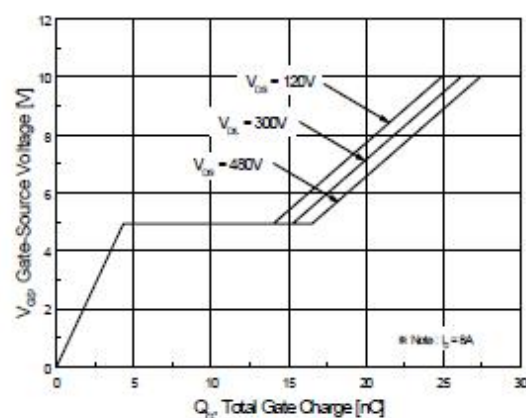

Figure 6. Gate Charge Characteristics

Typical Characteristics

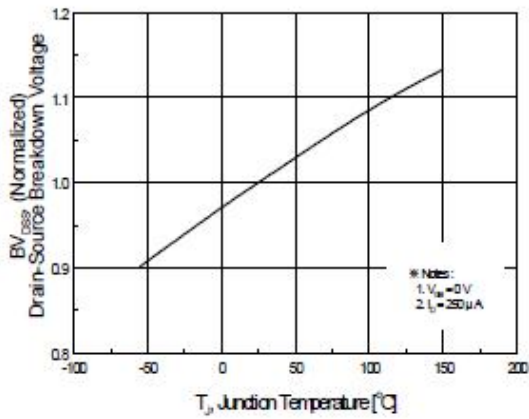

Figure 7. Breakdown Voltage Variation vs Temperature

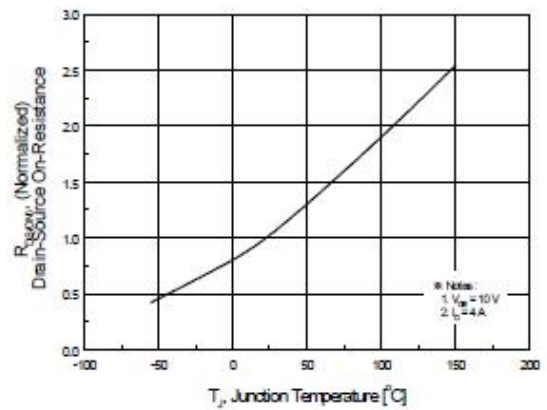

Figure 8. On-Resistance Variation vs Temperature

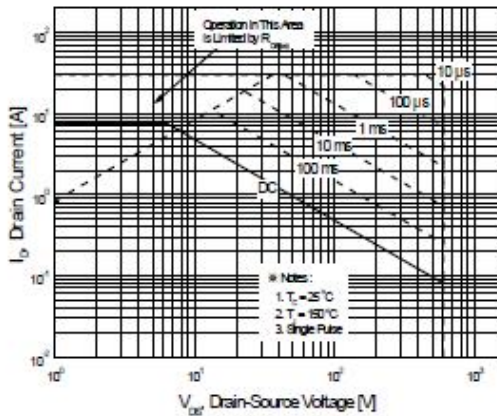

Figure 9-2. Maximum Safe Operating Area

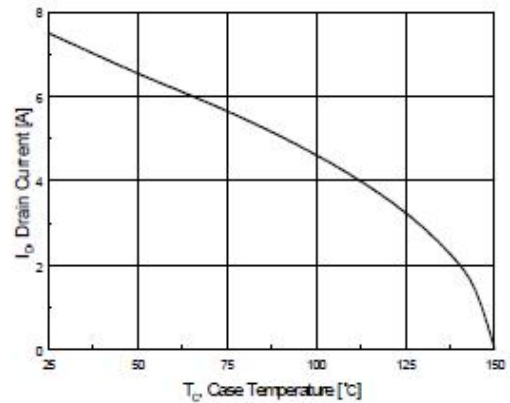

Figure 10. Maximum Drain Current vs Case Temperature

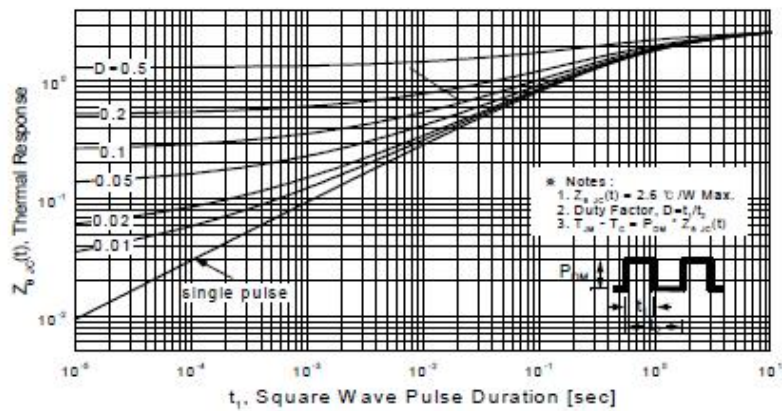
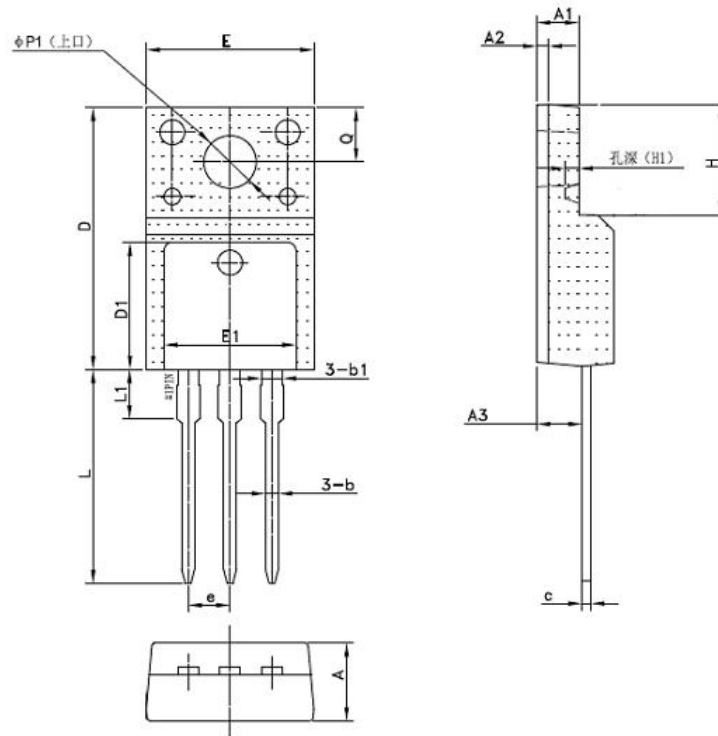

Figure 11-2. Transient Thermal Response Curve

SE8N65A

Package Outline Dimension

TO-220F



Symbol	Dimensions(mm)		
	Min.	Typ.	Max.
A	4.50	4.70	4.90
A1	2.44	2.54	2.64
A2	0.60	0.70	0.80
A3	2.56	2.76	2.96
b	0.70	0.80	0.95
b1	-	1.28	-
c	0.45	0.50	0.65
D	15.67	15.87	16.07
D1	-	7.70	-
E	9.96	10.16	10.36
E1	-	8.00	-
e	2.54(BSC)		
H	6.50	6.70	6.90
(H1)	-	(0.81)	-
L	12.48	12.98	13.20
L1	-	2.93	-
$\Phi P1$	2.98	3.18	3.38
Q	3.10	3.30	3.50

The SINO-IC logo is a registered trademark of ShangHai Sino-IC Microelectronics Co., Ltd.

© 2005 SINO-IC – Printed in China – All rights reserved.

SHANGHAI SINO-IC MICROELECTRONICS CO., LTD

Add: Building 3, Room 3401-03, No.200 Zhangheng Road, ZhangJiang Hi-Tech Park, Pudong,
Shanghai 201203, China

Phone: +86-21-33932402 33932403 33932405 33933508 33933608

Fax: +86-21-33932401

Email: webmaster@sino-ic.net

Website: <http://www.sino-ic.net>

X-ON Electronics

Largest Supplier of Electrical and Electronic Components

Click to view similar products for [MOSFET](#) category:

Click to view products by [SINO-IC](#) manufacturer:

Other Similar products are found below :

[614233C](#) [648584F](#) [IRFD120](#) [IRFF430](#) [JANTX2N5237](#) [2N7000](#) [FCA20N60_F109](#) [FDZ595PZ](#) [AOD464](#) [2SK2267\(Q\)](#) [2SK2545\(Q,T\)](#)
[405094E](#) [423220D](#) [MIC4420CM-TR](#) [VN1206L](#) [614234A](#) [715780A](#) [SSM6J414TU,LF\(T](#) [751625C](#) [BSC884N03MS G](#) [BSF024N03LT3 G](#)
[PSMN4R2-30MLD](#) [TK31J60W5,S1VQ\(O](#) [2SK2614\(TE16L1,Q\)](#) [DMN1017UCP3-7](#) [EFC2J004NUZTDG](#) [FCAB21350L1](#) [P85W28HP2F-](#)
[7071](#) [DMN1053UCP4-7](#) [NTE2384](#) [NTE2969](#) [NTE6400A](#) [DMN2080UCB4-7](#) [DMN61D9UWQ-13](#) [US6M2GTR](#) [DMN31D5UDJ-7](#)
[SSM6P54TU,LF](#) [DMP22D4UFO-7B](#) [IPS60R3K4CEAKMA1](#) [DMN1006UCA6-7](#) [DMN16M9UCA6-7](#) [STF5N65M6](#) [STU5N65M6](#)
[C3M0021120D](#) [DMN13M9UCA6-7](#) [BSS340NWH6327XTSA1](#) [MCM3400A-TP](#) [DMTH10H4M6SPS-13](#) [IRF40SC240ARMA1](#)
[IPS60R1K0PFD7SAKMA1](#)