





Banana Pi
www.banana-pi.org

www.banana-pi.org

SINOVOIP CO., LIMITED

BANAPI TECH LIMITED

-  DongGuan Office: 7F, Rongyi Building, No.5 Information Rd, Songshan Lake High-tech Industrial Park, Dongguan
-  ShenZhen Office: Room 304, Block B, Digital Bldg. Garden City, No.1079 Nanhai Avenue, Shekou, Nanshan District, Shenzhen, Guangdong, China
-  +86-755-26475332
-  +86-755-26068531
-  www.banana-pi.org



**WE WORK
FOR THE
BEST SERVICE**



ABOUT US

COMPANY PROFILE

SINOVOIP was found in 2003, Located in Shenzhen, Guangdong. We have our own factory and R&D team. We have been doing R&D in embedded systems for more than 20 years, we can do OEM&ODM for you, our experienced team are able to help you design your own product

500+

Our team

10000M²

Production base

20Years

SCM experience

DEVELOPMENT COURSE



FOUNDED IN 2003

2003

SINOVOIP CO.,LIMITED and Factory were established in 2004, mainly in communication product and do OEM&ODM for customers

2004-2008

SINOVOIP develop series Voip Gateway, Voip Asterisk Card

2009-2012

SINOVOIP develop series POE Products

2013

SINOVOIP begin Develop Banana Pi Board

2014-2017

Established Guangdong BIPAI KEJI.CPA.,Ltd in Dongguan, set up headquarter and Banana Pi R&D team there

2017-2020

Banana Pi begin to develop products base on Realtek, Mediatek , Amlogic , Sunplus., etc

2021-2023

Rockchip series products come out during this period, currently there are mainly RK3888/RK3568/3308, we will keep developing new products

Future

SINOVOIP will continue to concentrate on this industry, develop more products and provide more better service to customers

CERTIFICATES

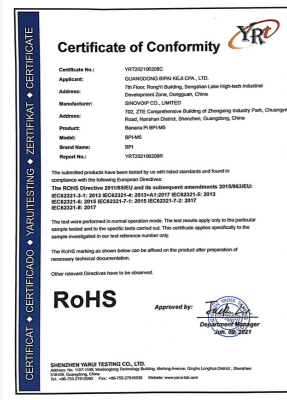

INTRODUCED

PRODUCT CATALOG

PRODUCT INTRODUCTION Single board computer Series and Smart Router

Amlogic Series

BPI-M5	01	BPI-M3	33
BPI-M2 Pro	03	BPI-M64	35
BPI-M2S(A311D)	05	BPI-M1+	37
BPI-M2S(S922X)	07	BPI-M1	39
BPI-CM4	09		
BPI-CM4 Base Board	11		
BPI-CM5	13		

MediaTek Series

BPI-R3 Mini	15		
BPI-R3	17		
BPI-R4	19		
BPI-R64	21		

Allwinner Series

BPI-M2 Zero	23		
BPI-P2 Zero	25		
BPI-M2+	27		
BPI-M2 Berry	29		
BPI-M2 Ultra	31		

Synaptics Series

BPI-M6	41
--------	----

Rockchip Series

BPI-P2 Pro	43
BPI-R2 Pro	45
BPI-W3	47

Realtek Series

BPI-W2	49
--------	----

SunPlus Series

BPI-F2P	51
BPI-Steam Education Products	53

Banana Pi BPI-M5



4GB LPDDR4

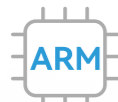

Quad-core
64-Bit SOC



16GB eMMC



Gigabit Ethernet

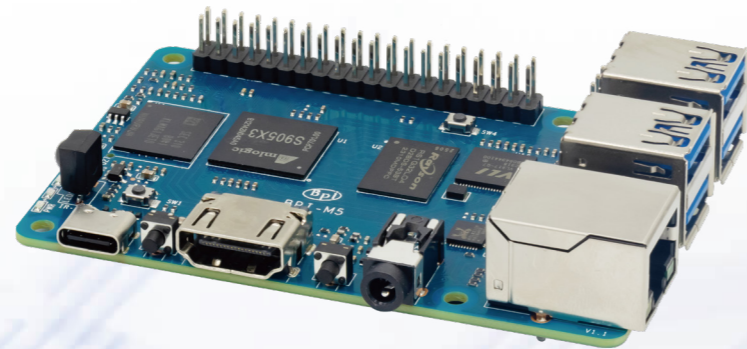

- Amlogic S905X3, Quad-core Cortex-A55, 64-Bit SOC
- Mali-G31 GPU
- 4GB LPDDR4 SDRAM
- 16GB eMMC
- 4x USB 3.0
- 10/100/1000mbps Ethernet RJ45
- HDMI 2.1 connector
- DC 5V 2A Type-C

Hardware
interface

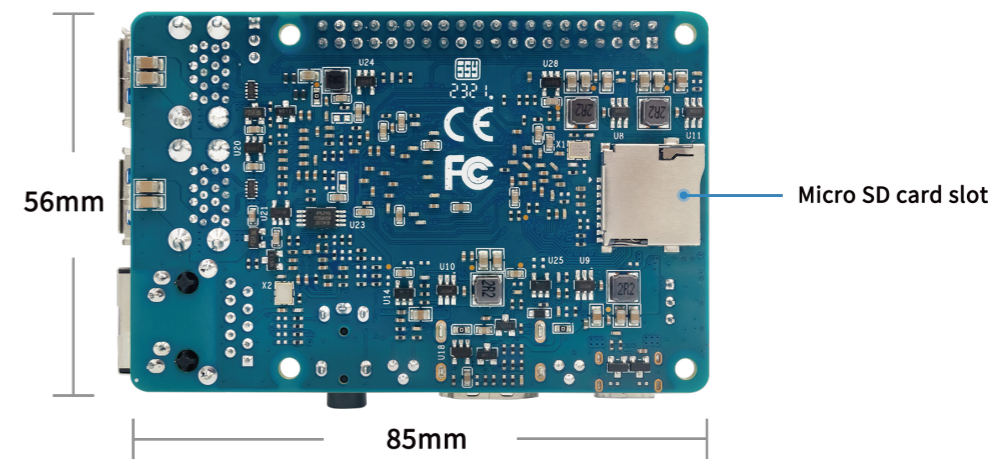
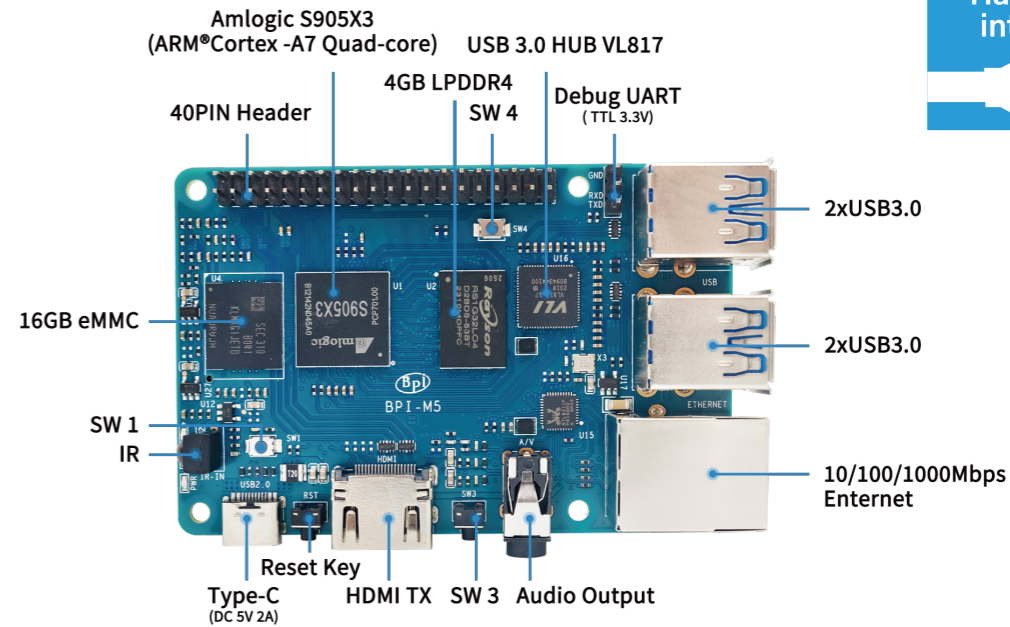

Banana Pi BPI-M2 Pro



2GB LPDDR4

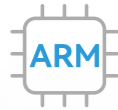

Quad-core
64-Bit SOC



16GB eMMC



Wi-Fi & BT

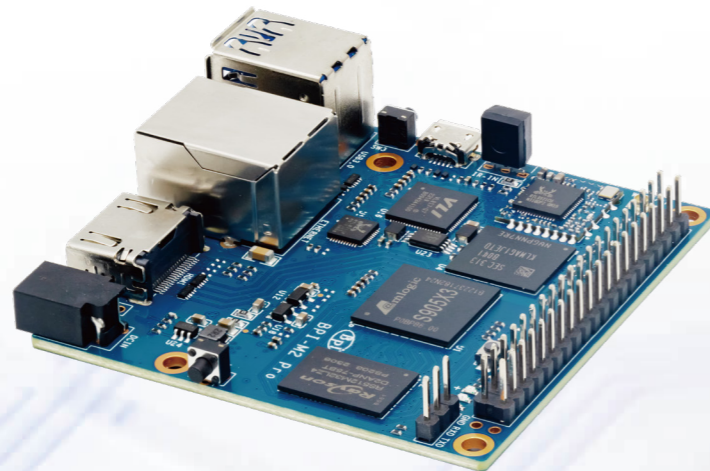

- Amlogic S905X3, Quad-core Cortex-A55, 64-Bit SOC
- Mali-G31 GPU
- 16GB eMMC
- 2GB LPDDR4 SDRAM
- 10/100/1000mbps Ethernet RJ45
- Wi-Fi (RTL8821) & BT 4.2 onboard
- HDMI 2.1 connector
- 2x USB 3.0
- 5V 2A DC Power

Hardware
interface

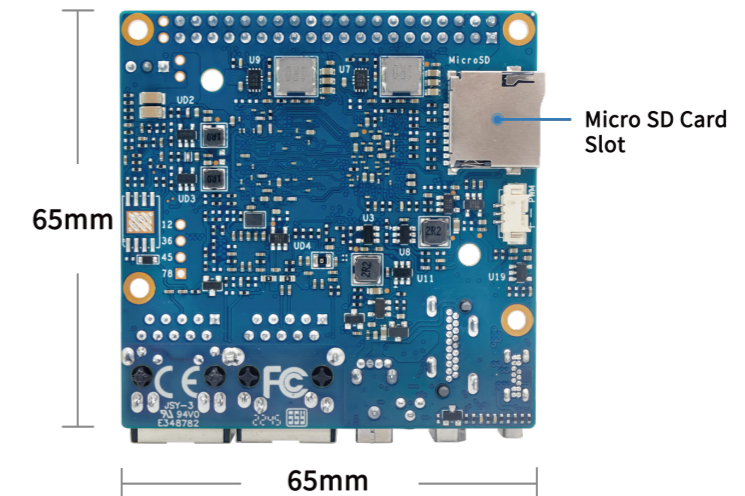
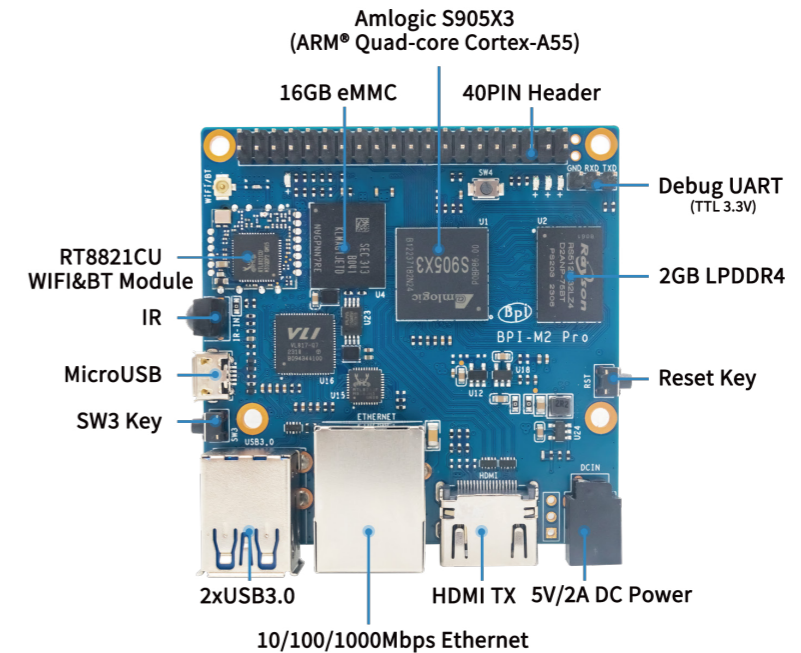

Banana Pi BPI-M2S(A311D)

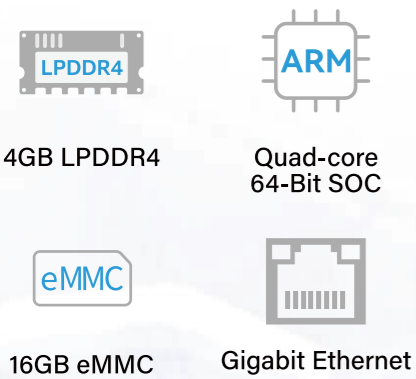

- Amlogic A311D, Quad-core Cortex-A73 and Dual-core Cortex-A53, 64-Bit SOC
- NPU for AI :Next generation, deep-neural-network applications, at 5.0 TOPS
- 4GB LPDDR4 SDRAM
- 16GB eMMC
- MIPI DSI Display connector
- MIPI CSI camera connector
- 2x Gigabit Ethernet RJ45
- 40PIN Header
- HDMI 2.1 connector
- DC 5V 2A Type-C

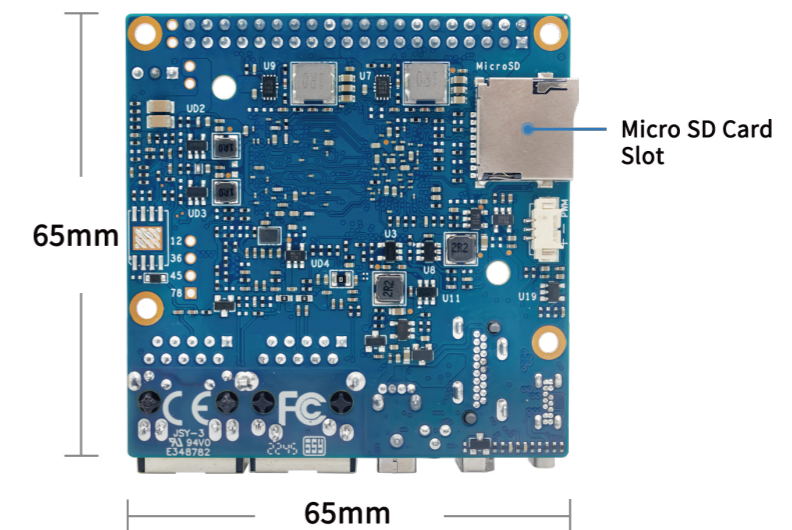
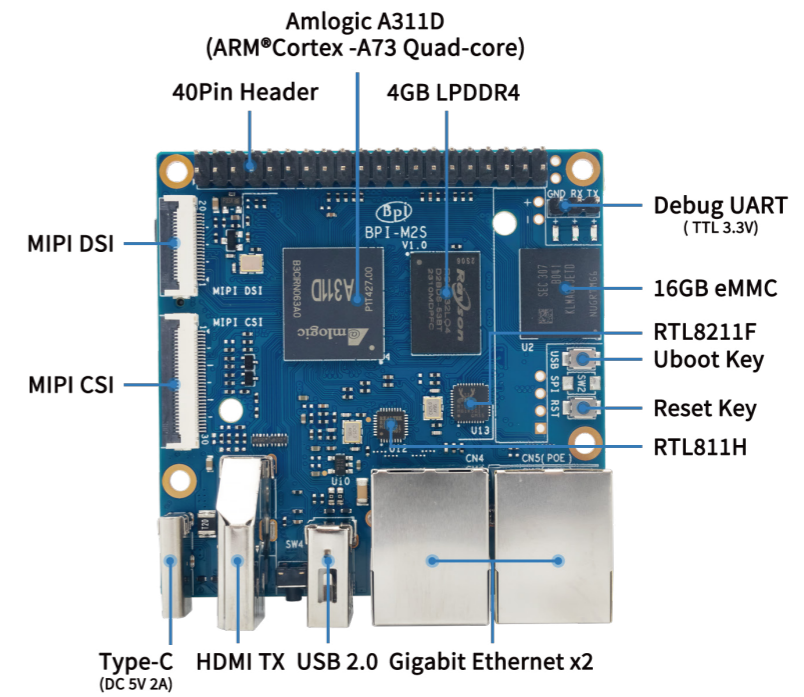
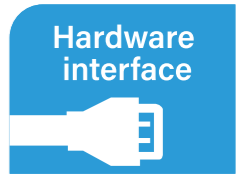

Banana Pi BPI-M2S(S922X)



2GB LPDDR4

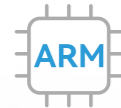

Quad-core
64-Bit SOC



16GB eMMC



Gigabit Ethernet

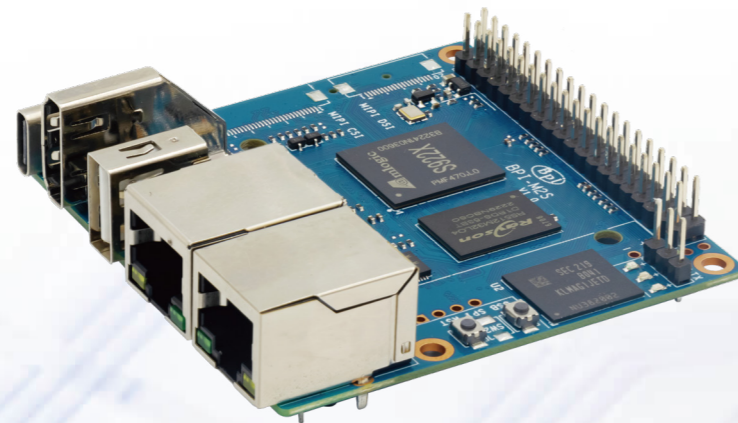

- Amlogic S922X, Quad-core Cortex-A73 and Dual-core Cortex-A53, 64-Bit SOC
- 2GB LPDDR4 SDRAM
- 16GB eMMC
- 40PIN Header
- HDMI 2.1 connector
- DC 5V 2A Type-C
- 2x Gigabit Ethernet RJ45

Hardware
interface

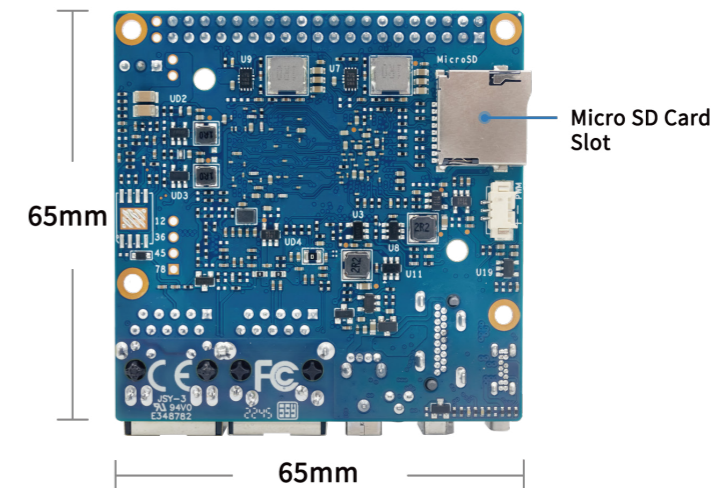
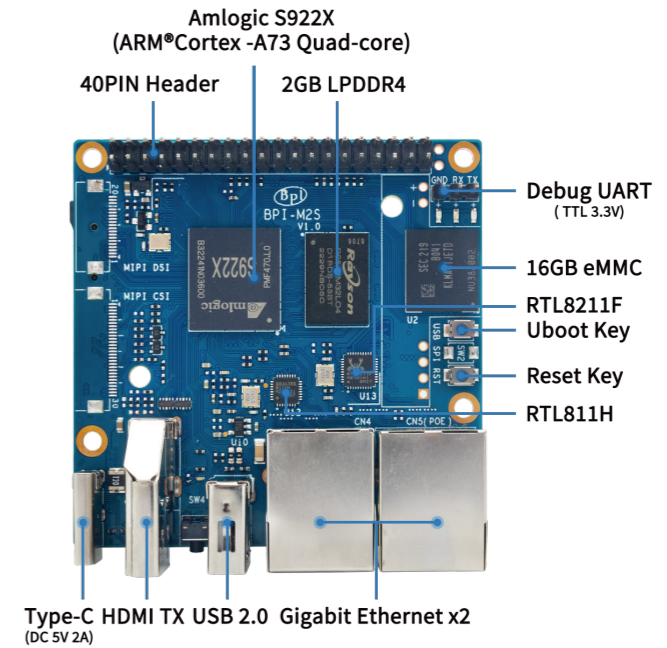

Banana Pi BPI-CM4



4GB LPDDR4

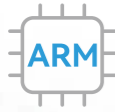

Quad-core
64-Bit SOC



16GB eMMC



Wi-Fi & BT



- Amlogic A311D, Quad-core Cortex-A73 and Dual-core Cortex-A53, 64-Bit SOC
- 4GB LPDDR4 SDRAM
- 16GB eMMC
- Wi-Fi (RTL8822CS) & BT 5.0 onboard
- MIPI DSI Display connector
- MIPI CSI camera connector
- HDMI 2.1 connector
- 10/100/1000mbps Ethernet
- 100Pin highspeed connector, 100Pin GPIO connector

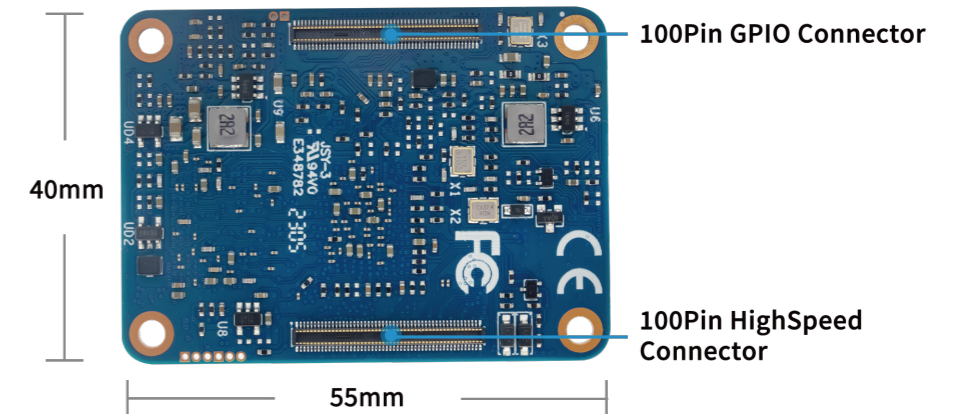
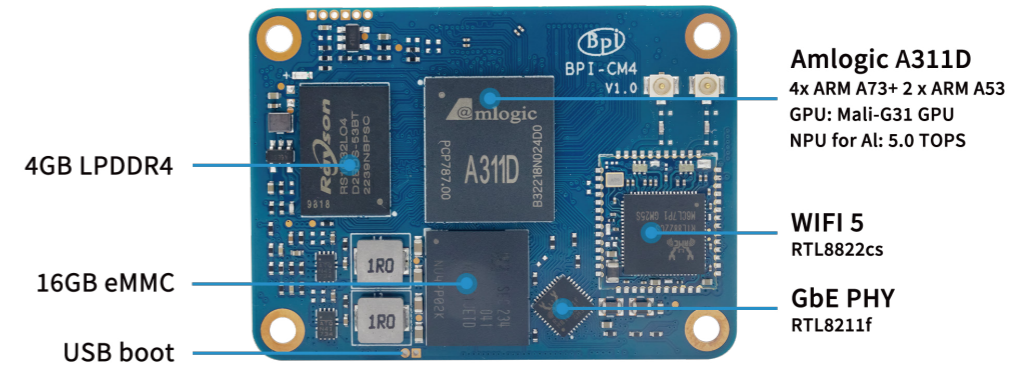

Banana Pi BPI-CM4 Base Board

- 10/100/1000mbps Ethernet RJ45
- 2x USB 2.0
- HDMI connector
- MicroSD, Slot
- mPCIe(Pcie+USB2.0) Slot, NANOSIM
- Reset Key, ADC Key
- DC 5V 2A Type-C
- MIPI DSI Display connector
- MIPI CSI camera connector
- 26PIN Header

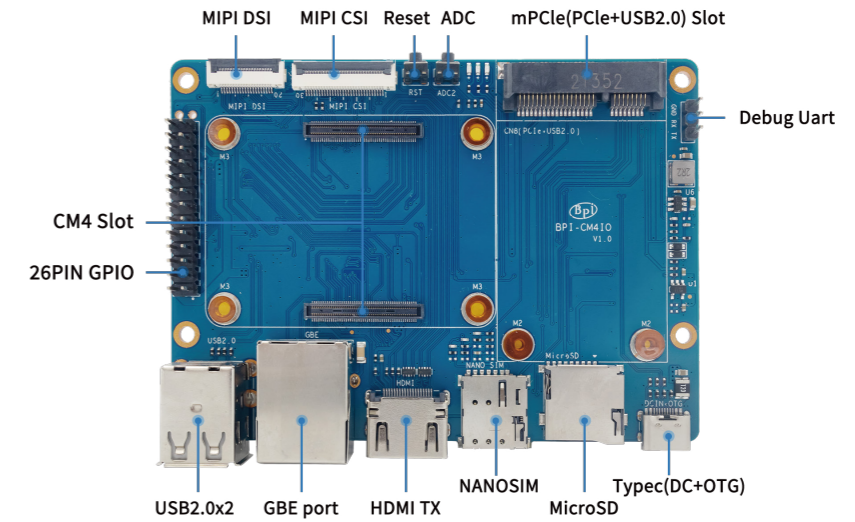
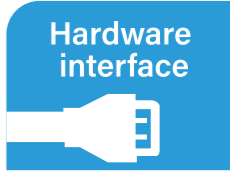

CM4 Base Board

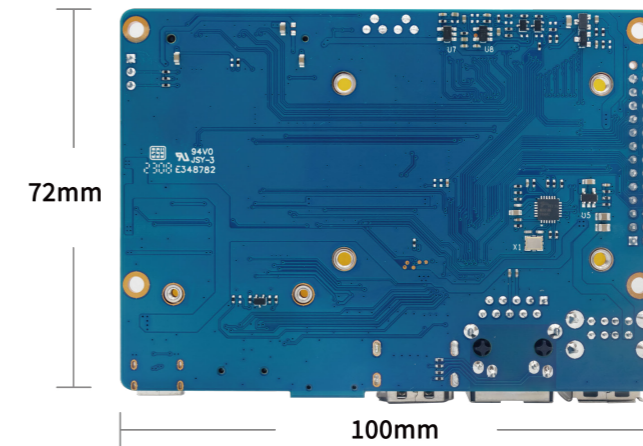
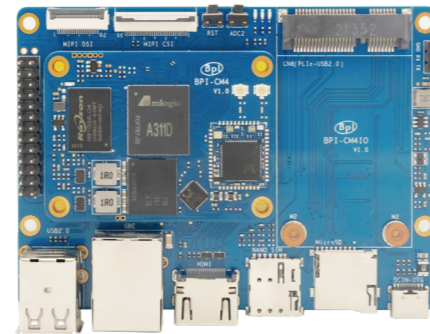
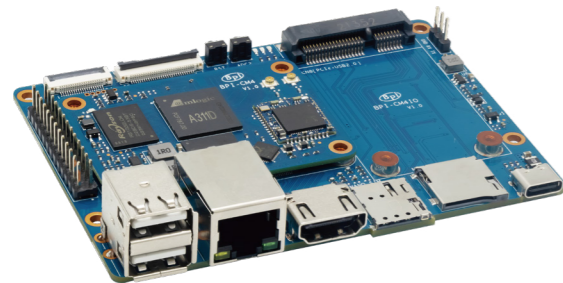

Banana Pi BPI-CM5

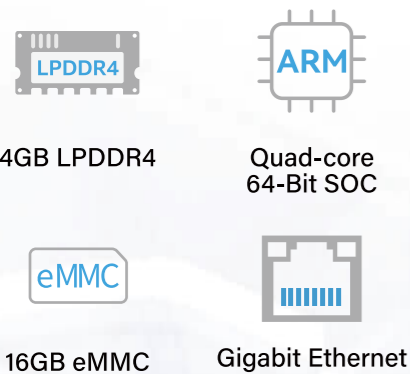
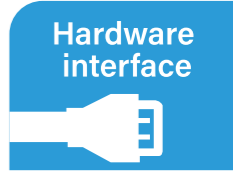

- Amlogic A311D2, Quad-core Cortex-A73 and Quad-core Cortex-A53, 64-Bit SOC
- 16GB eMMC
- 4GB LPDDR4/LPDDR4x (Max 8G)
- 3x HDMI2.1 receiver
- 1x HDMI2.1 transmitter
- 1x USB2.0 OTG
- 1x USB3.0
- 1x PCIe2.0
- 10/100/1000mbps Ethernet
- 100Pin highspeed connector, 100Pin GPIO connector
- 2x 8-lane V-by-One output can support up to 4Kx2K resolution(Multiplexing with MIPI-DSI/eDP/LVDS)
- 2x 4-lane MIPI-CSI camera interface with 16Mp ISP

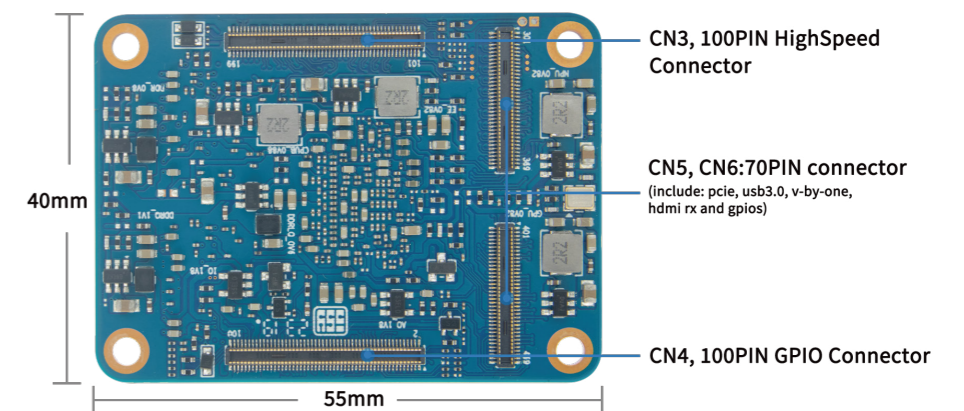
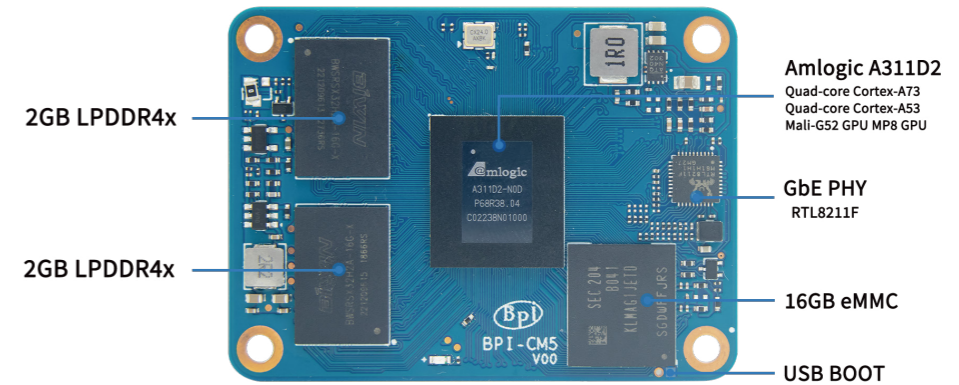

Banana Pi BPI-R3 MINI

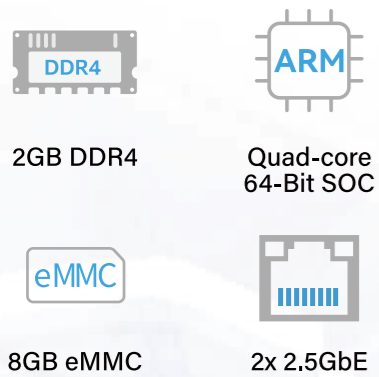

- MediaTek MT7986A(Filologic 830), Quad-core Cortex-A53, 64-Bit SOC
- Wi-Fi 6 2.4G/5G(MT7976C)
- 2GB DDR4 SDRAM
- 8GB eMMC flash
- 128MB SPI Nand flash
- 2x 2.5GbE Ethernet RJ45
- 1x M.2 KEY B USB interface
- 1x M.2 KEY M PCIe interface
- 1x USB2.0
- PD 12V 1.6A Type-C

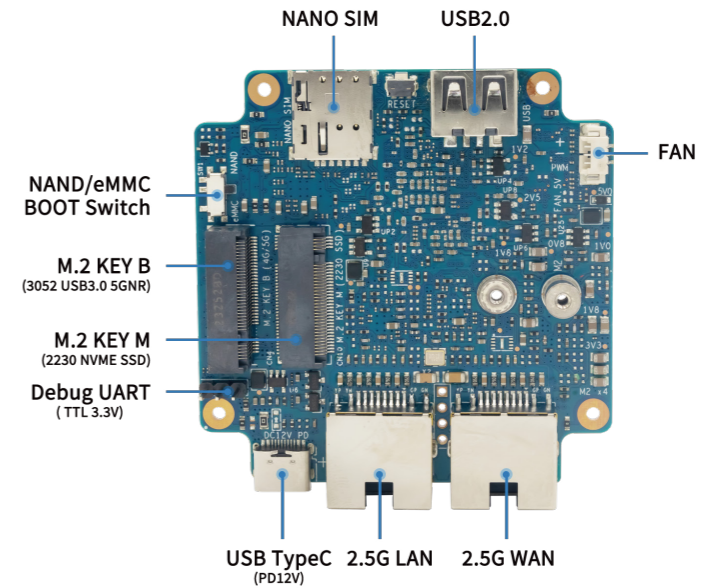
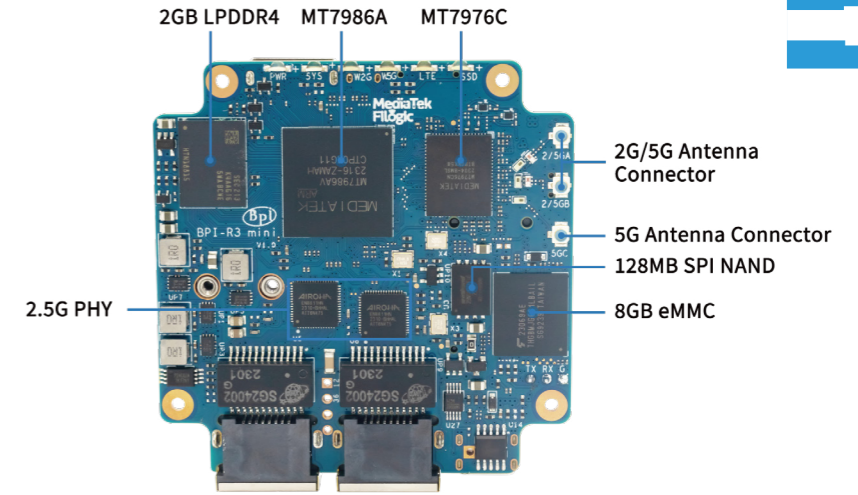
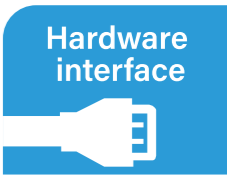

Banana Pi BPI-R3

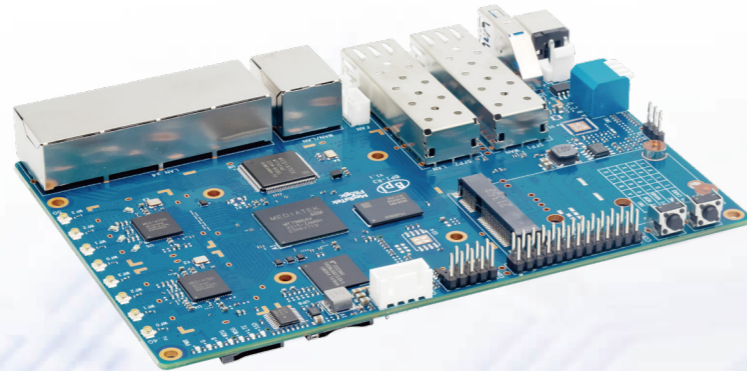
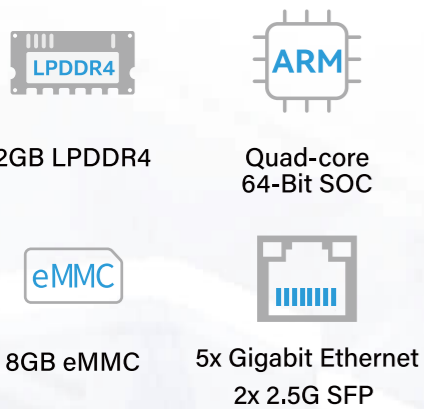

- MediaTek MT7986A(Filic 830), Quad-core Cortex-A53, 64-Bit SOC
- MT7531 Switch
- Wi-Fi 6 4x4 2.4G(MT7975N) +4x4 5G(MT7975P)
- 2GB DDR4 SDRAM
- 8GB eMMC
- 128MB SPI Nand
- 32MB SPI NOR
- Micro SD card Slot
- Mini PCIe (USB 2.0)
- 2x 2.5G SFP
- 5xGbE RJ45
- M.2 KEY-M PCIe Slot
- 26PIN Header
- 12V 2A DC IN

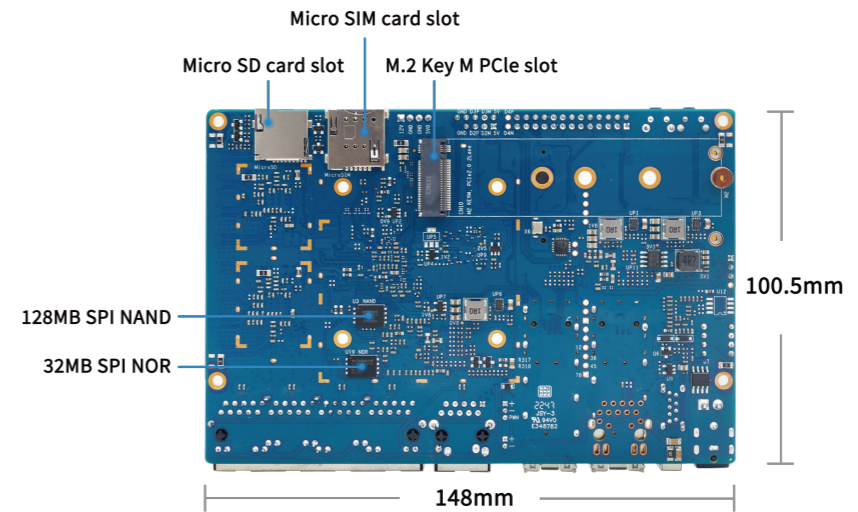
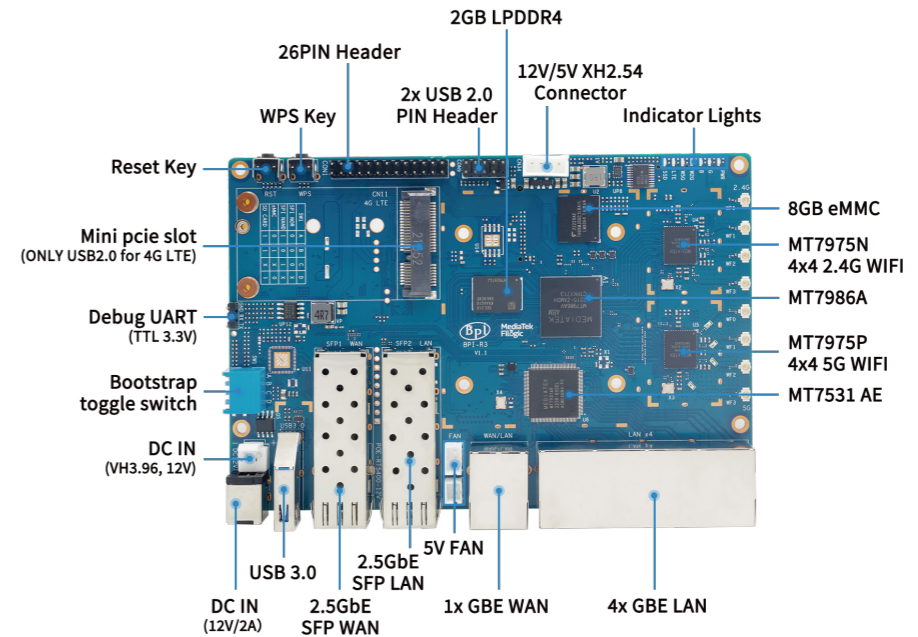
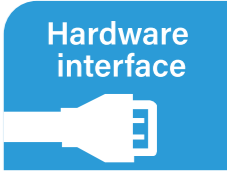

Banana Pi BPI-R4

4GB DDR4

Quad-core 64-Bit SOC

8GB eMMC

4x Gigabit Ethernet
2x 10GbE SFP

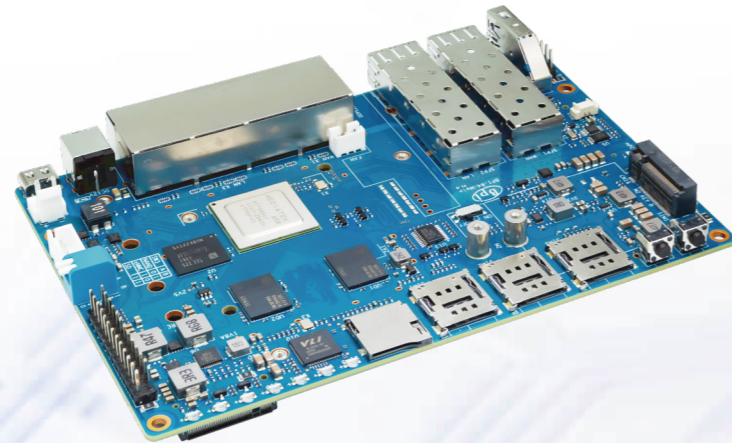



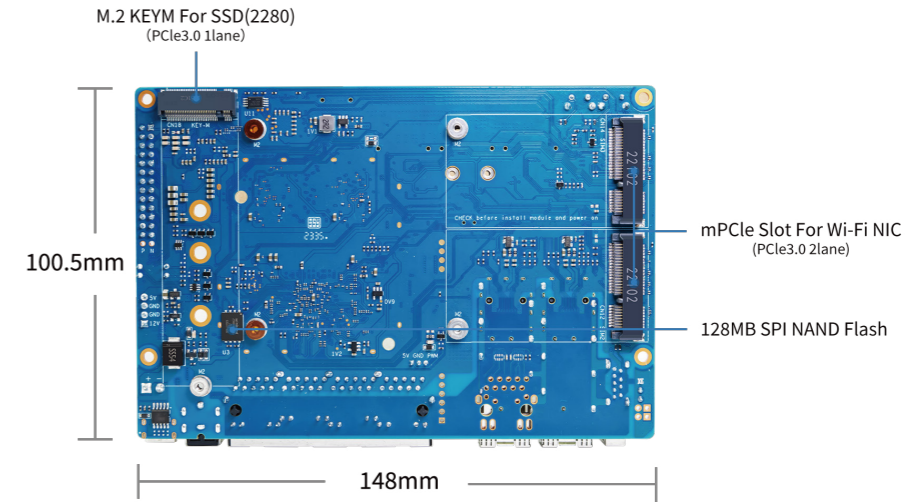
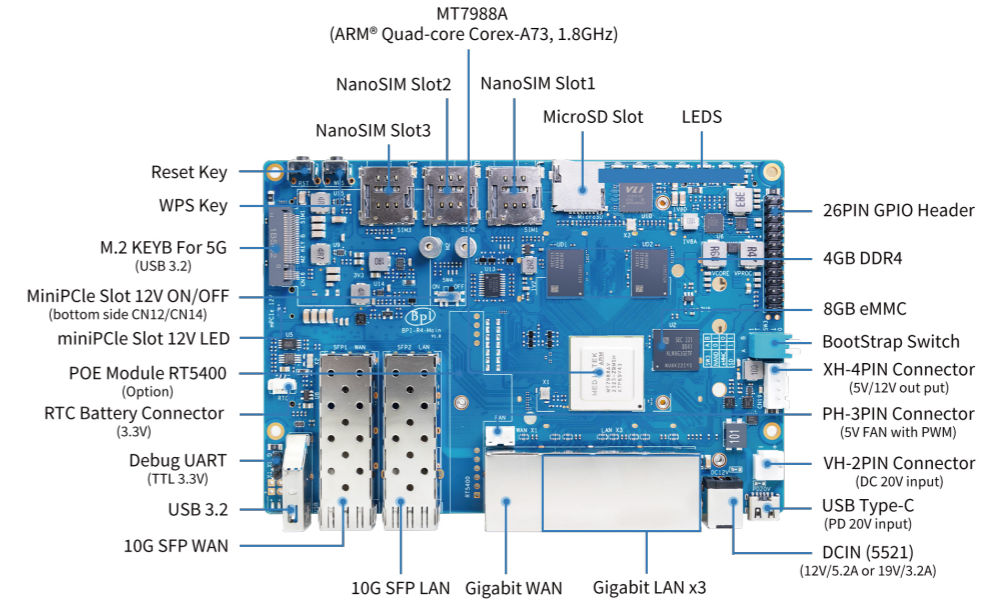
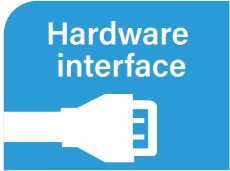

- MediaTek MT7988A (Filogic 880) quad-core Arm Corex-A73,1.8GHz processor
- 4GB DDR4
- 8GB eMMC flash
- Micro SD card slot
- 2x 10GbE SFP slot (option 1x 10GbE SFP and 1x SOC embedded 2.5GbE PHY)
- 1x M.2 KEY-M slot with PCIe3.0 1lane interface for NVME SSD
- 1x M.2 KEY-B slot with USB3.2/PCIe interface for 5G
- 2x miniPCIe slots with PCIe3.0 2lane interface for Wi-Fi7 NIC (Network Interface Card)
- 26PIN Header for expanding application
- 1x USB3.2 slot
- 128MB SPI-NAND Flash
- 4x Gbe network port



Banana Pi BPI-R64



 **1GB DDR3**
 **Dual-core 64-Bit SOC**
 **8GB eMMC**
 **5x Gigabit Ethernet**

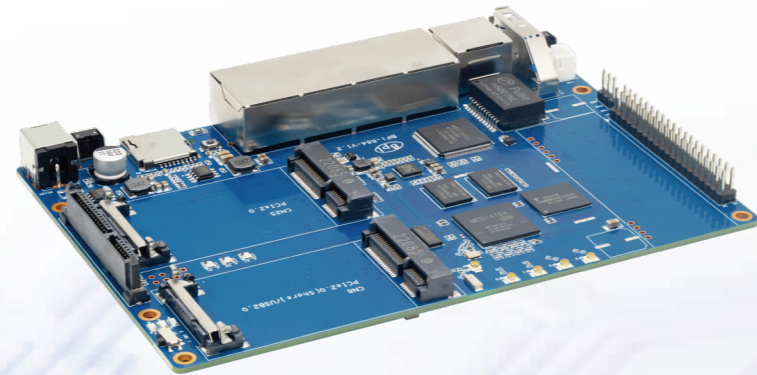

- MediaTek MT7622, 1.35GHz Dual-core Cortex-A53, 64 Bit SOC
- 8GB eMMC
- 1GB DDR3 SDRAM
- built-in 4x4 802.11n/BT 5.0
- MicroSD Slot
- 5x 10/100/1000mbps Ethernet RJ45
- POE function(option)
- Mini PCIE interface support 4G module
- MT7615 4x4ac Wi-Fi module(option)
- 1x SATA Slot
- 2x USB 3.0
- 12V 2A DC IN

MediaTek MT7622
 1.35GHZ 64 bit dual-core ARM Cortex-A53

4x4 2.4G WiFi Antenna Connector
8GB eMMC
BT5.0 Antenna
PCIe 2.0&USB 2.0

40PIN Header
1GB DDR3
PoE module slot
Debug UART (TTL 3.3V)
5V Fan
WPS Key

Boot Select
SATA
PCIe2.0
DC IN (12V/2A)

1 GbE WAN
4 GbE LAN
Reset Key
Recovery Key
Micro SD card slot

SPI Nand flash

Micro SIM Card Slot

148mm
100.5mm

Banana Pi BPI-M2 Zero

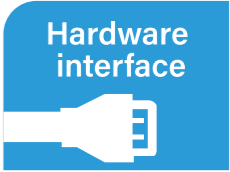

512MB DDR3

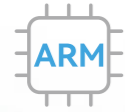

Quad-core
32-Bit SOC



USB 2.0



Wi-Fi & BT

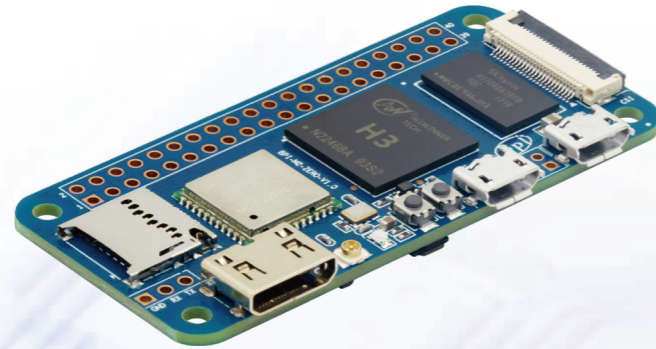

- Allwinner H3, 1.2GHz Quad-core Cortex-A7, 32-Bit SOC
- 512MB DDR3 SDRAM
- Wi-Fi & BT 4.0 onboard
- Mini HDMI 1.4 connector
- 40PIN Header
- 5V 2A Micro USB Power

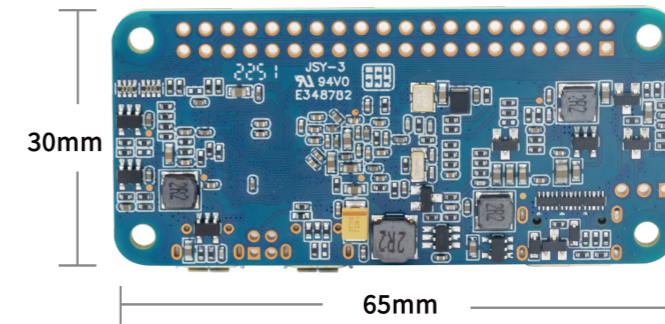
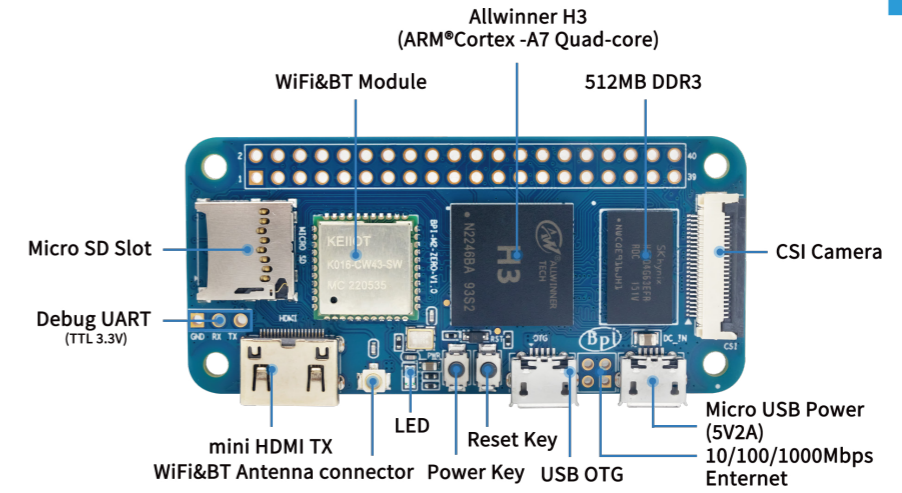

Banana Pi BPI-P2 Zero

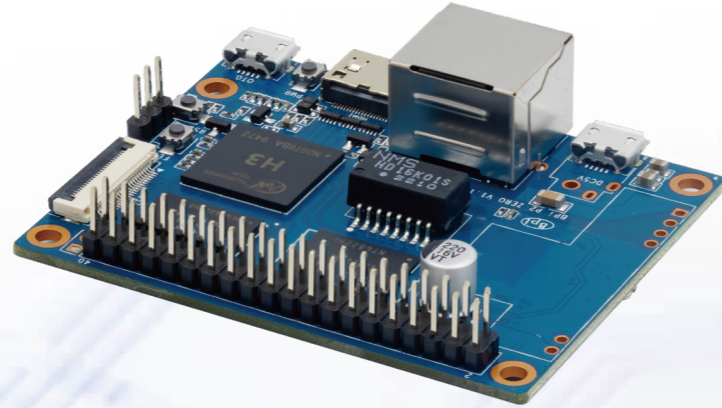
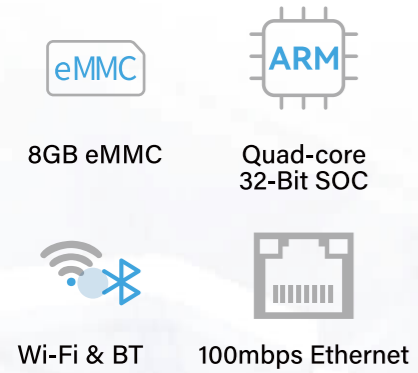

- Allwinner H3, 1.2GHz Quad-core Cortex-A7, 32-Bit SOC
- 512MB DDR3 SDRAM
- 8GB eMMC
- Mini HDMI 1.4 connector
- Wi-Fi & BT 4.0 onboard
- 10/100mbps Ethernet RJ45
- IEEE 802.3af PoE standard PoE module support
- 40PIN Header
- 5V 2A Micro USB Power

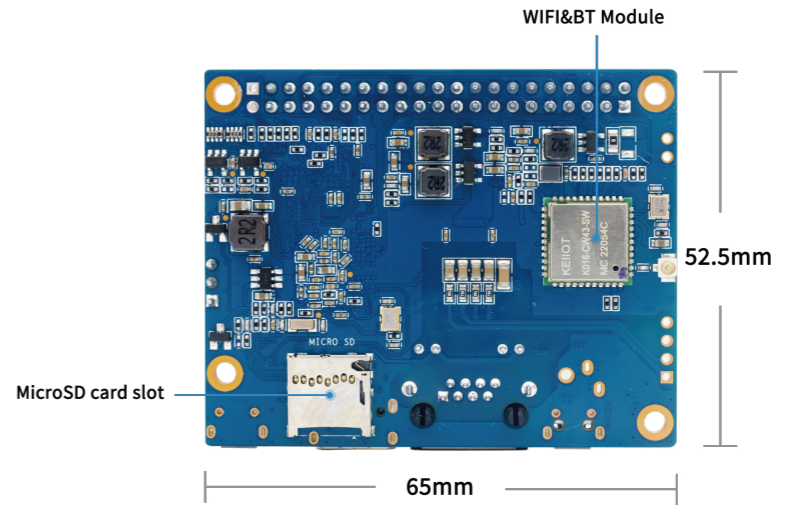
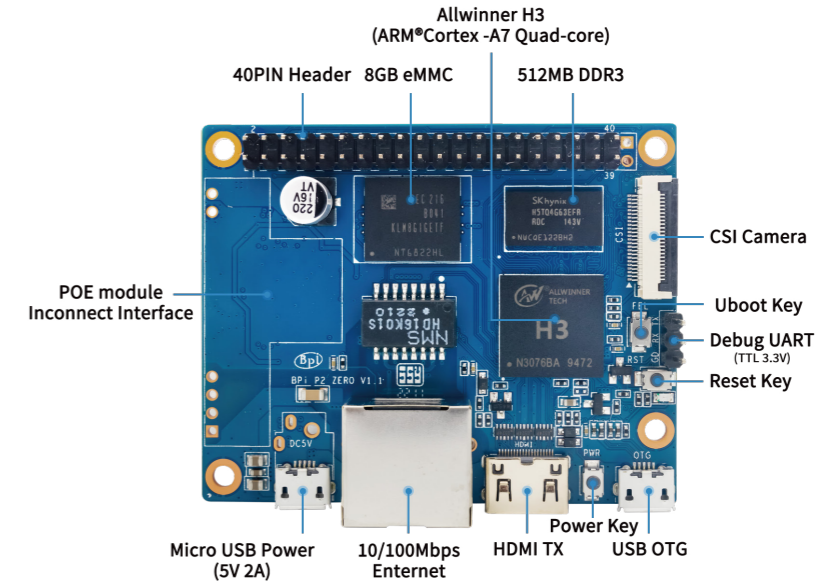
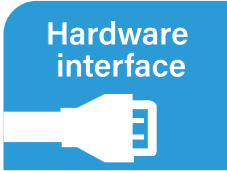

Banana Pi BPI-M2+



1GB DDR3

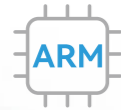

Quad-core
32-Bit SOC



8GB eMMC



Wi-Fi & BT



- Allwinner H3, 1.2GHz Quad-core Cortex-A7, 32-Bit SOC
- 1GB DDR3 SDRAM
- 8GB eMMC
- 10/100/1000mbps Ethernet RJ45
- HDMI 1.4 connector
- Wi-Fi & BT 4.0 onboard
- CSI camera connector
- 5V 2A DC Power

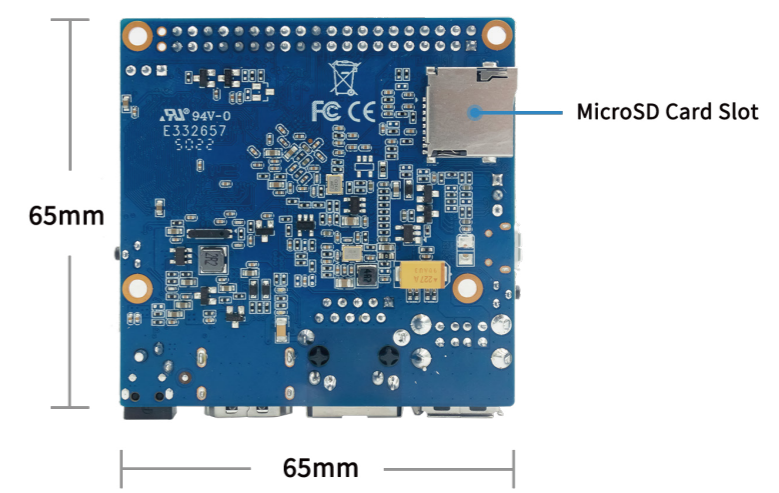
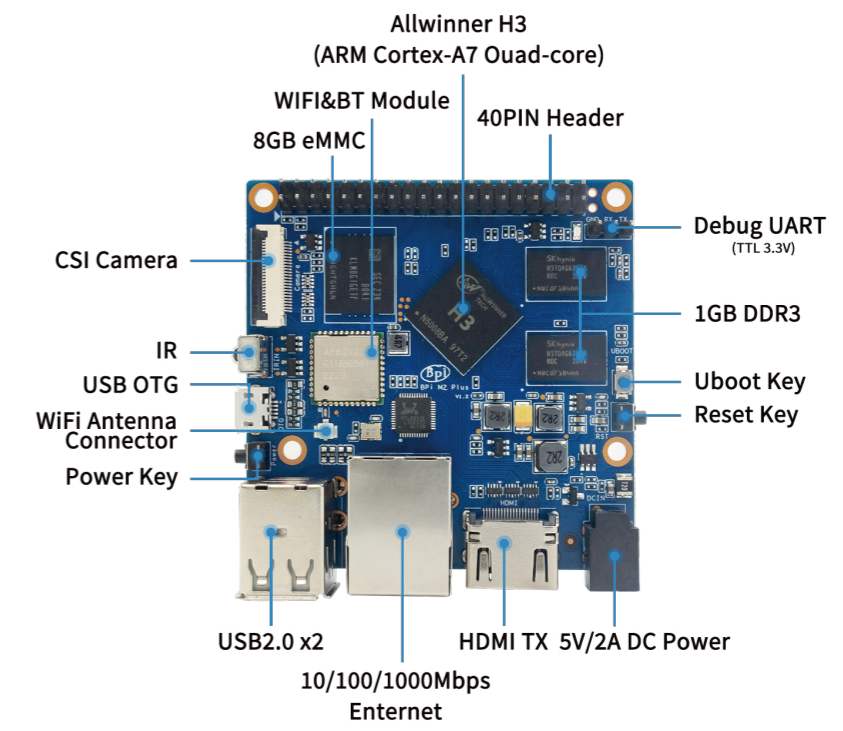
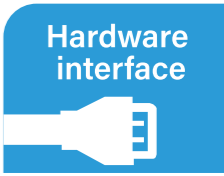

Banana Pi BPI-M2 Berry



1GB DDR3

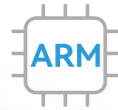

Quad-core 32-Bit SOC



USB 2.0



Wi-Fi & BT

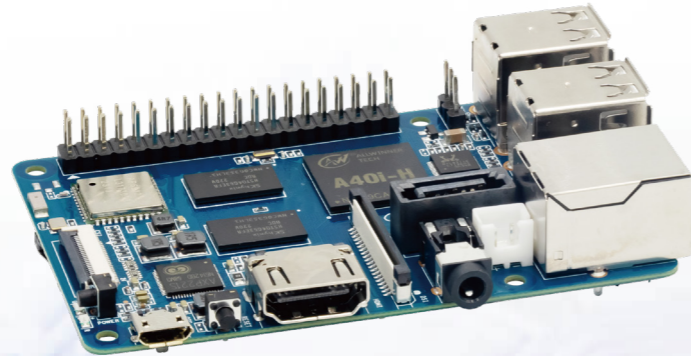

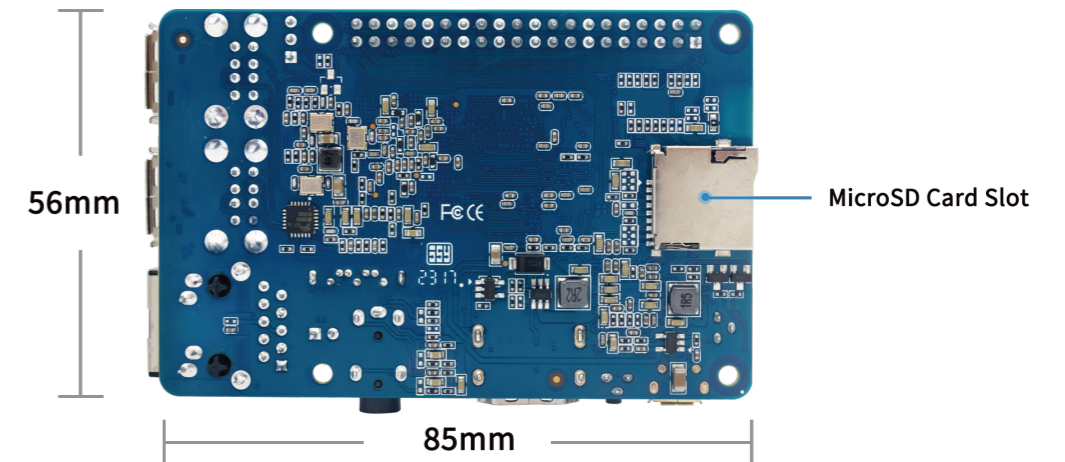
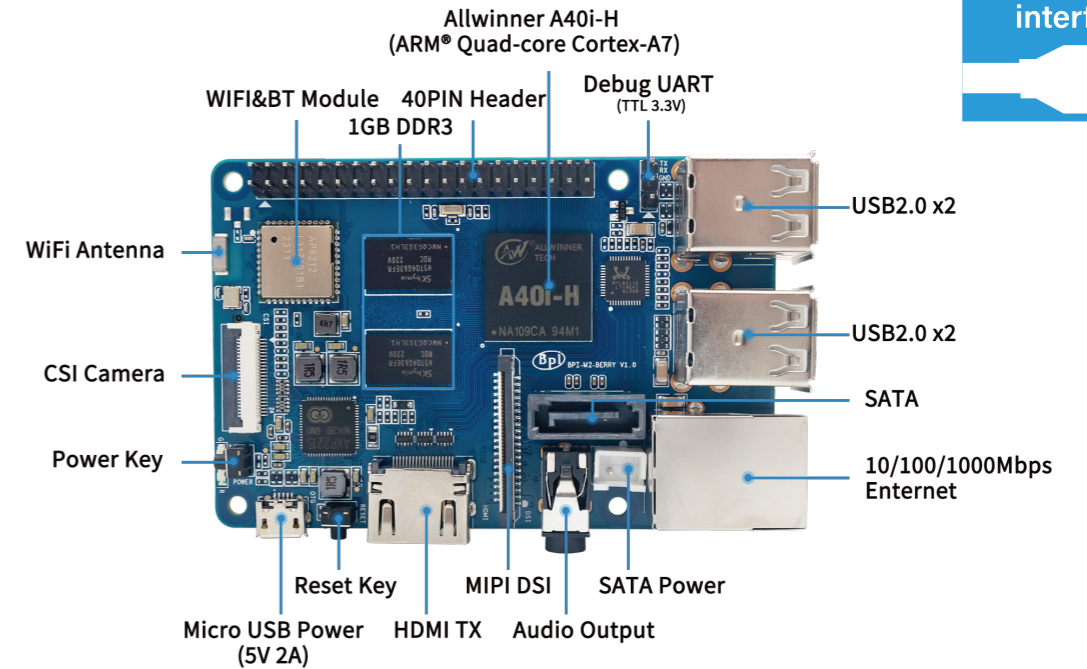
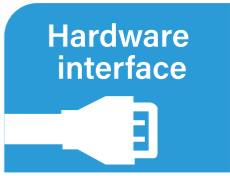

- Allwinner A40i, Quad-core Cortex-A7, 32-Bit SOC
- 1GB DDR3 SDRAM
- 4x USB 2.0
- Wi-Fi & BT4.0 onboard
- 10/100/1000mbps Ethernet RJ45
- HDMI 1.4 connector
- 40PIN Header
- CSI camera connector
- MIPI DSI connector
- 5V 2A Micro USB Power

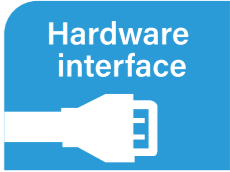

Banana Pi BPI-M2 Ultra

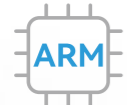

 **2GB DDR3**
 **Quad-core 32-Bit SOC**
 **USB 2.0**
 **Wi-Fi & BT**

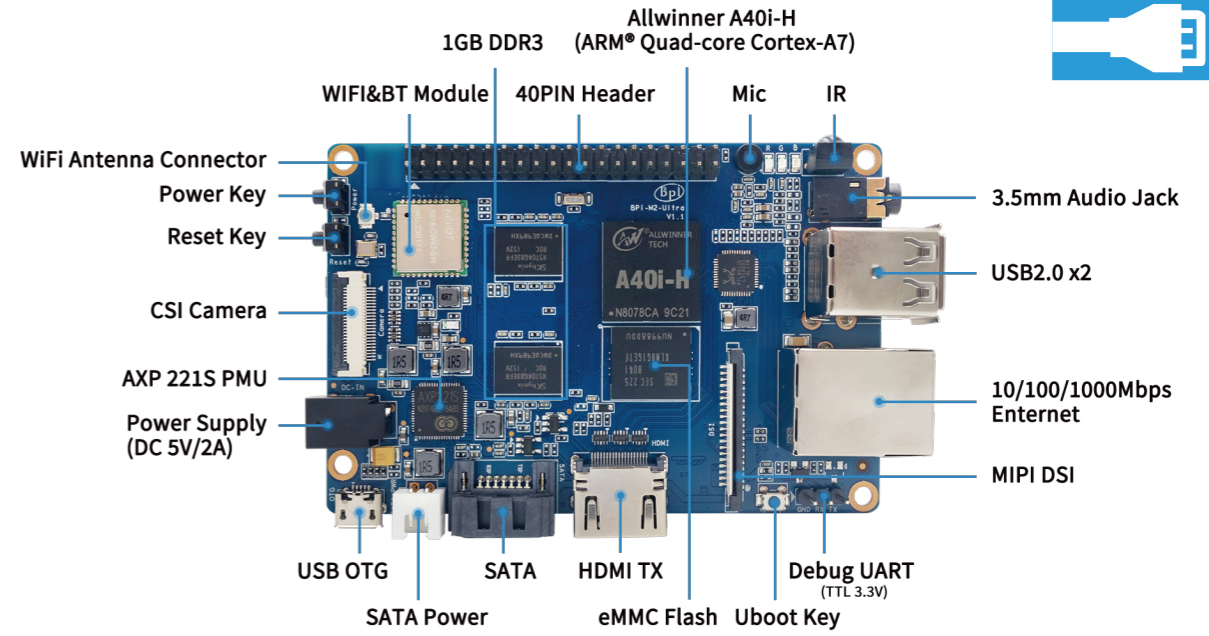

- Allwinner A40i, Quad-core Cortex-A7, 32-Bit SOC
- 8GB eMMC
- 2GB DDR3 SDRAM
- Wi-Fi&BT4.0 onboard
- 10/100/1000mbps Ethernet RJ45
- HDMI 1.4 connector
- 40PIN Header
- CSI camera connector
- MIPI DSI connector
- 5V 2A DC Power

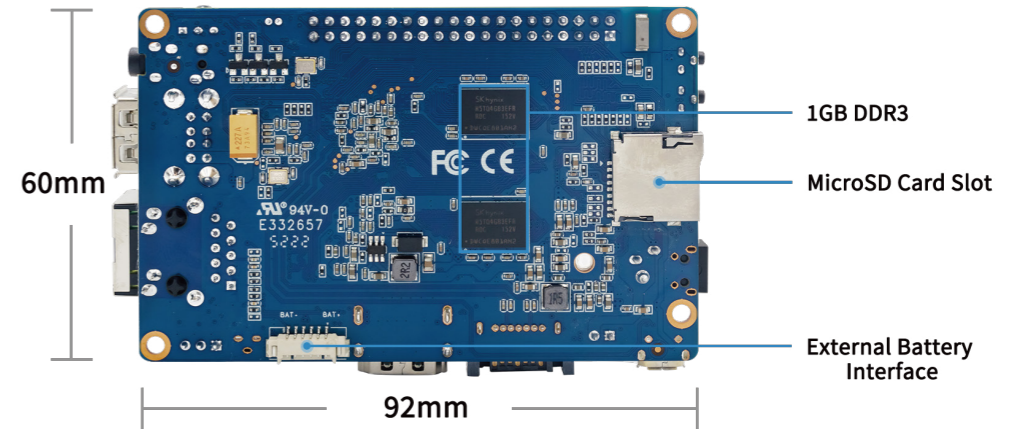

Banana Pi BPI-M3

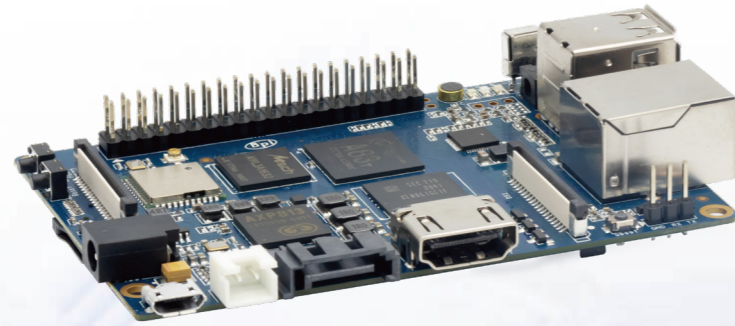
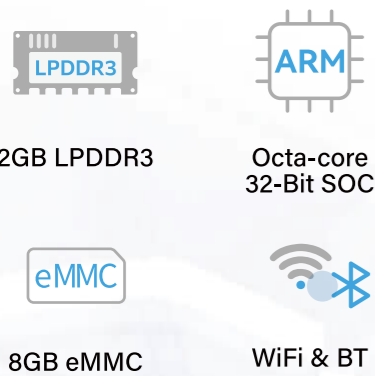

- Allwinner A83T, Octa-core 1.8GHz Cortex-A7, 32-Bit SOC
- 2GB LPDDR3 SDRAM
- 8GB eMMC
- 10/100/1000mbps Ethernet RJ45
- Wi-Fi&BT4.0 onboard
- 2x USB 2.0, 1xUSB OTG
- CSI camera connector
- MIPI DSI connector
- HDMI 1.4 connector
- 5V 2A DC Power

Hardware interface

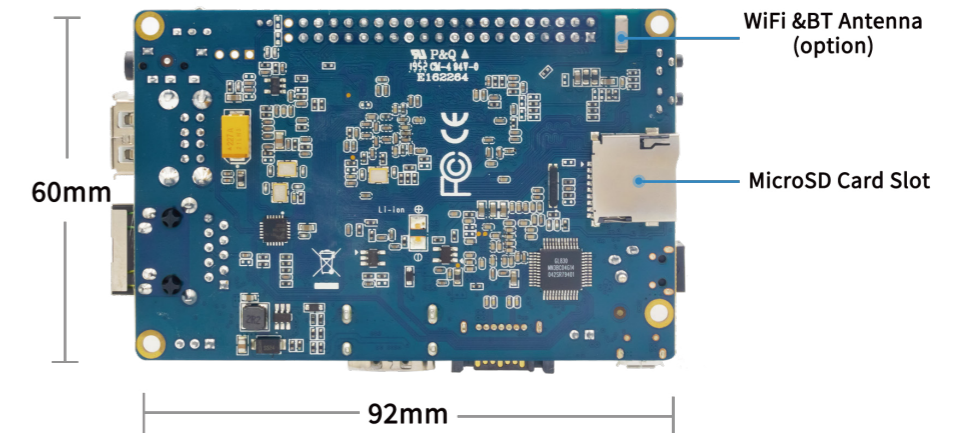
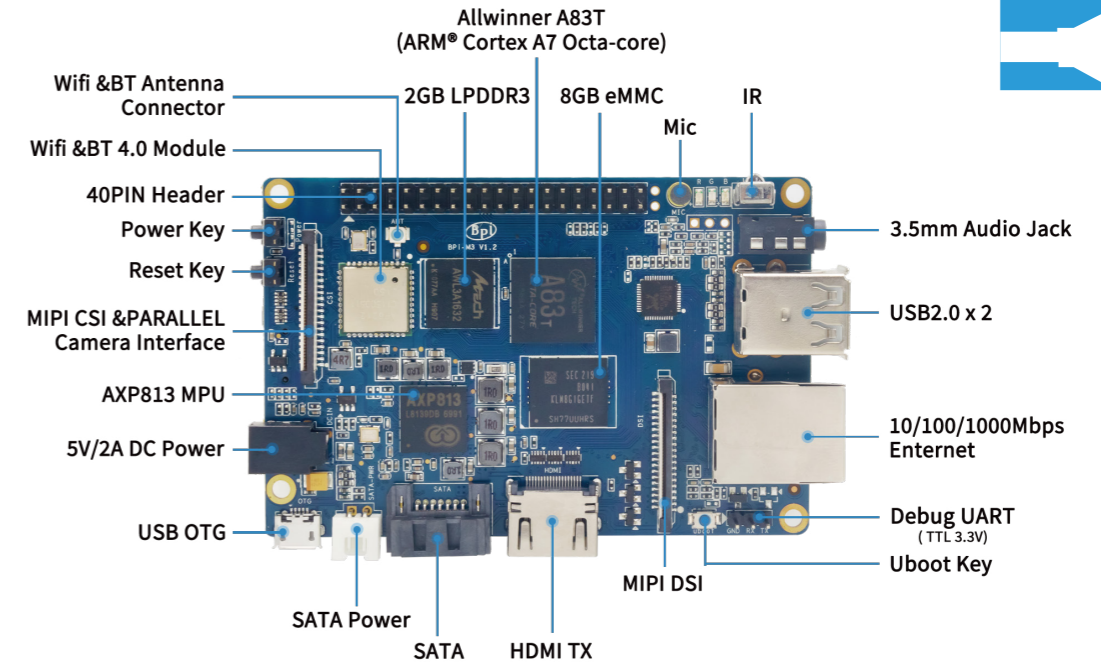

Banana Pi BPI-M64

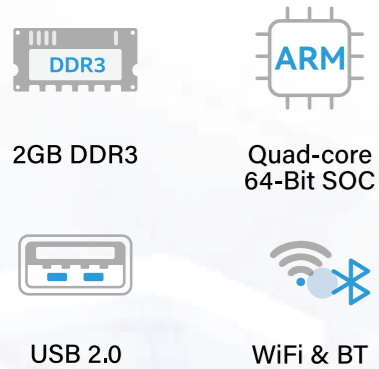

- Allwinner A64, 1.2GHz Quad-core Cortex-A53, 64-Bit SOC
- 2GB DDR3 SDRAM
- 8GB eMMC
- 10/100/1000mbps Ethernet RJ45
- Wi-Fi (AP6212) & BT 4.0 onboard
- 2x USB 2.0
- CSI camera connector
- MIPI DSI connector
- 5V 2A DC Power

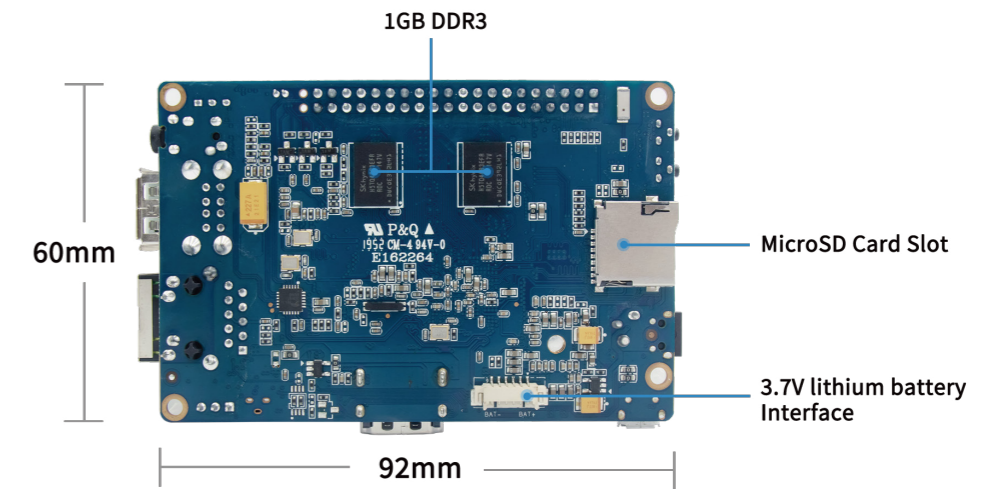
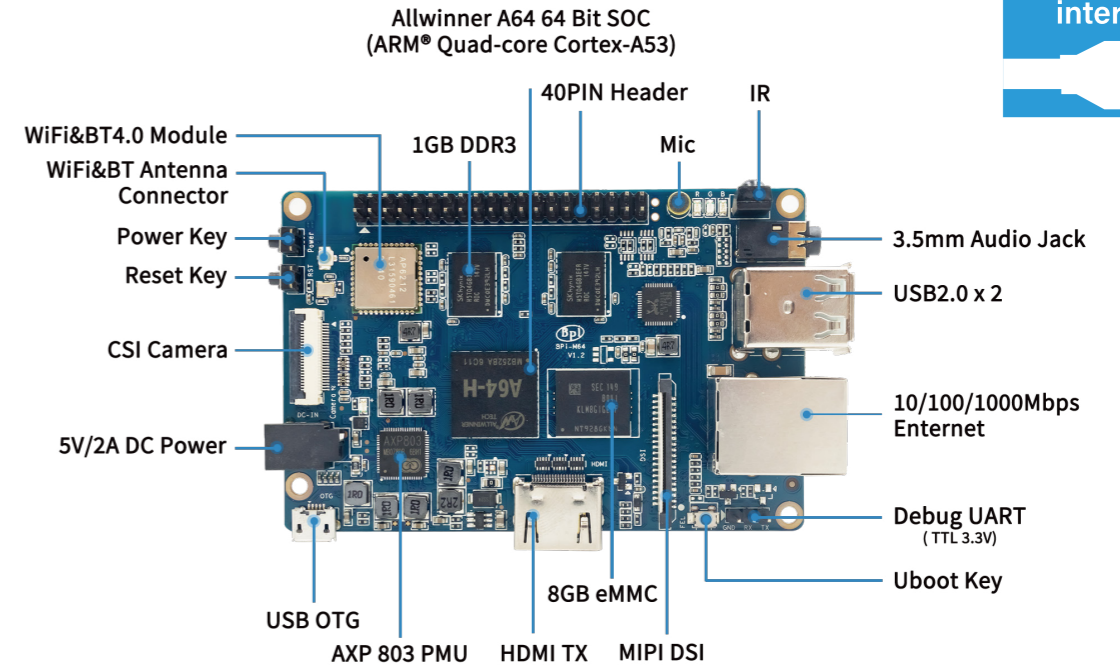
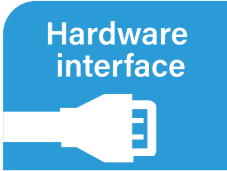

Banana Pi BPI-M1+

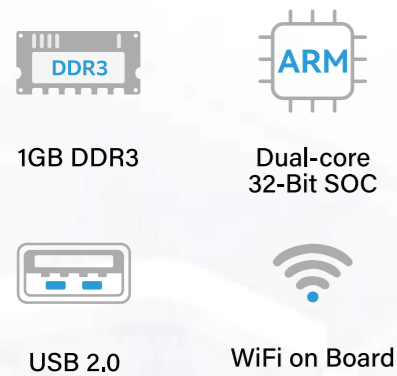

- Allwinner A20, Dual-core 1.0GHz Cortex-A7, 32-Bit SOC
- 1GB DDR3 SDRAM
- 10/100/1000mbps Ethernet RJ45
- 2x USB 2.0, 1x USB OTG
- Wi-Fi onboard
- 40PIN Header
- CSI camera connector
- LVDS, RGB Display connector
- 5V 2A Micro USB Power

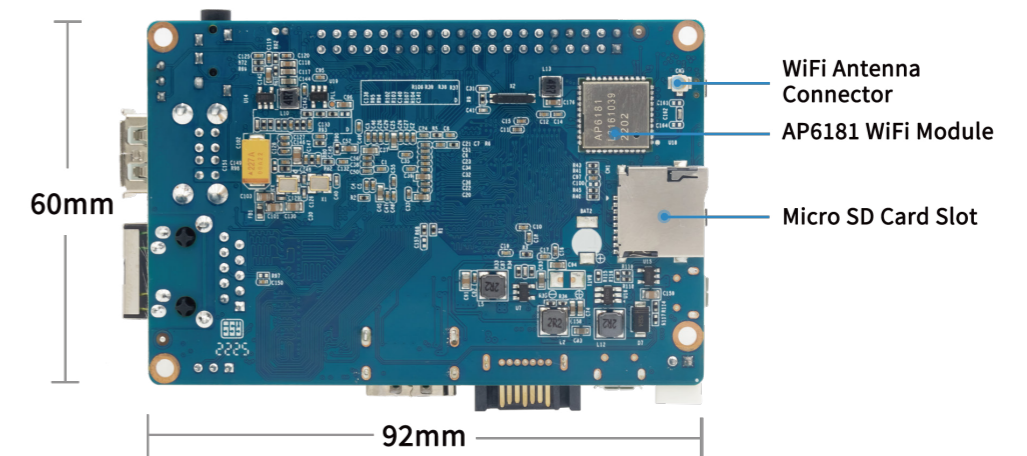
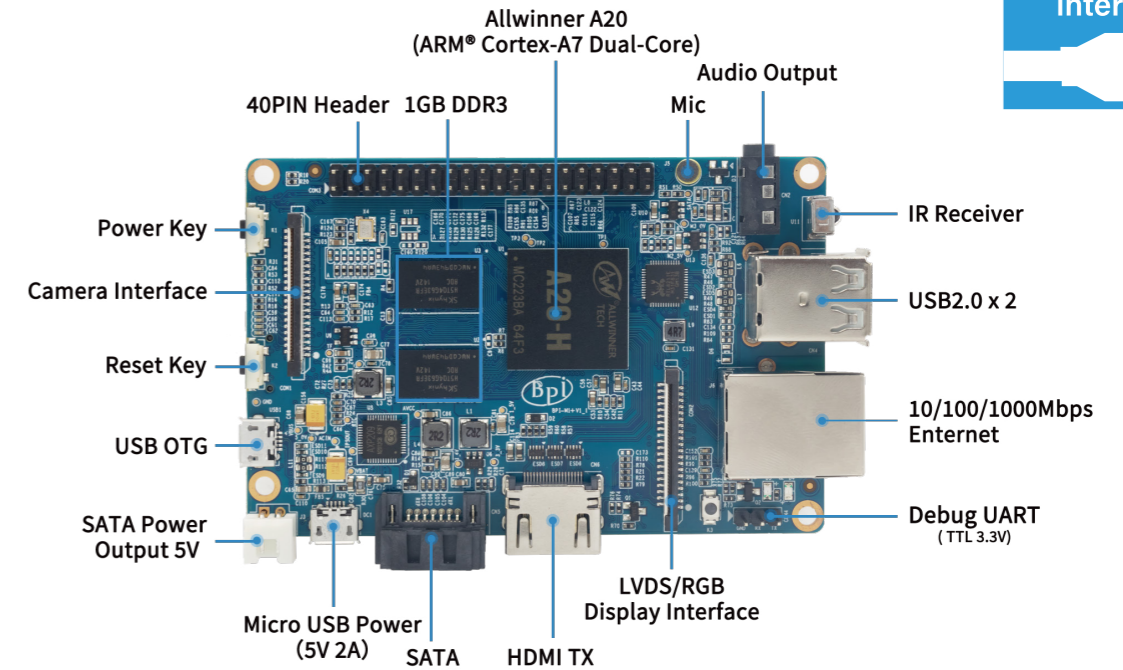

Banana Pi BPI-M1

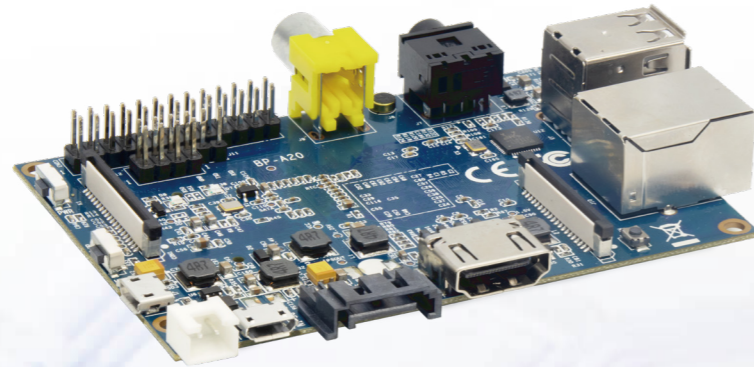
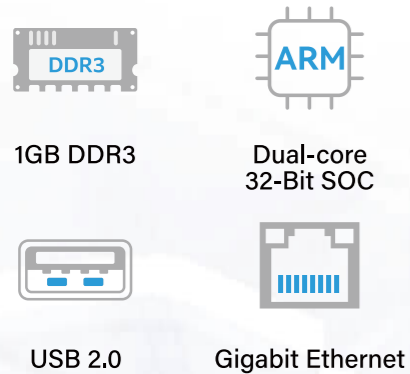

- Allwinner A20, Dual-core 1.0GHz Cortex-A7, 32-Bit SOC
- 1GB DDR3 SDRAM
- 10/100/1000mbps Ethernet RJ45
- HDMI 1.4 connector
- CSI camera connector
- LVDS, RGB Display connector
- 2x USB 2.0
- 26PIN Header
- 5V 2A Micro USB Power

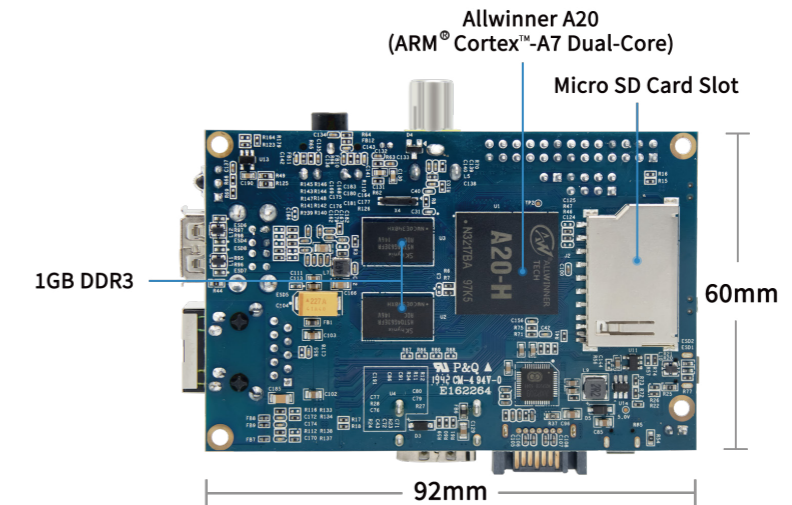
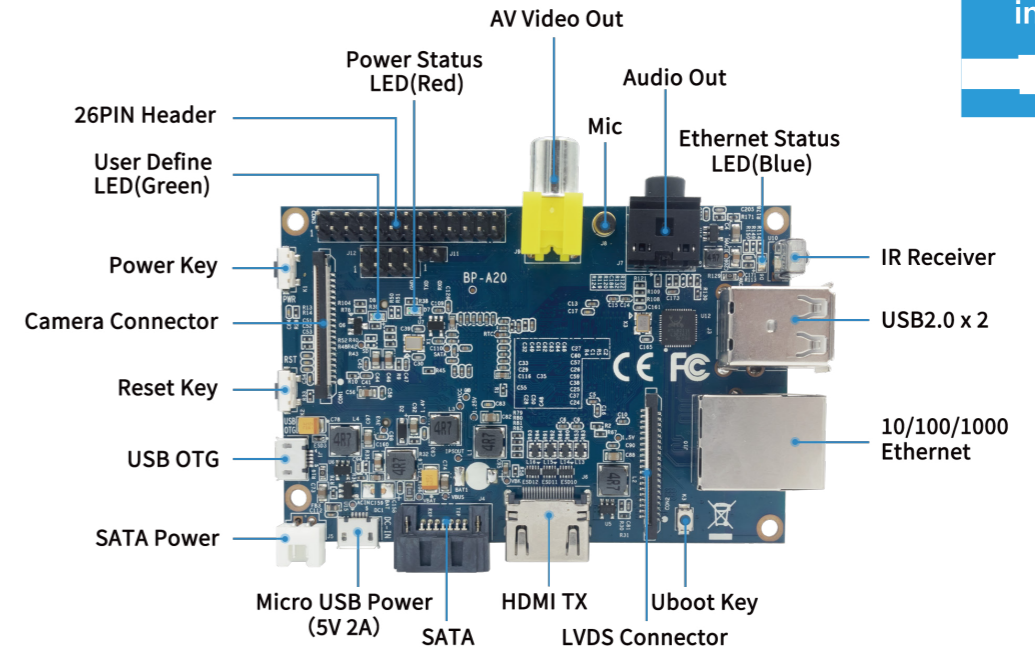
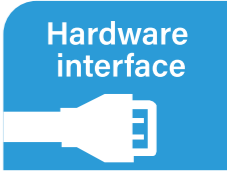



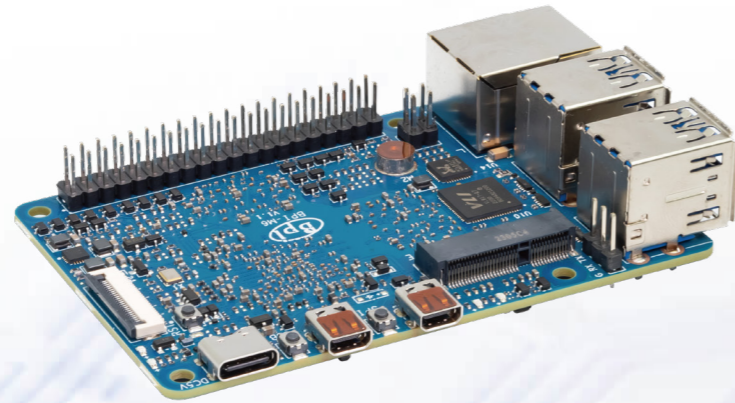
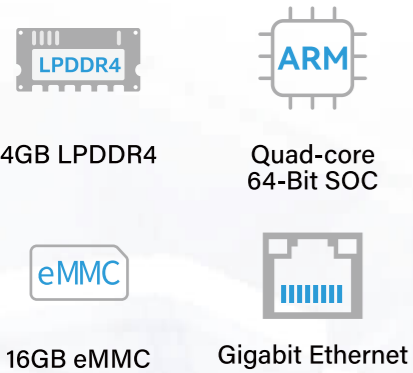

Banana Pi BPI-M6

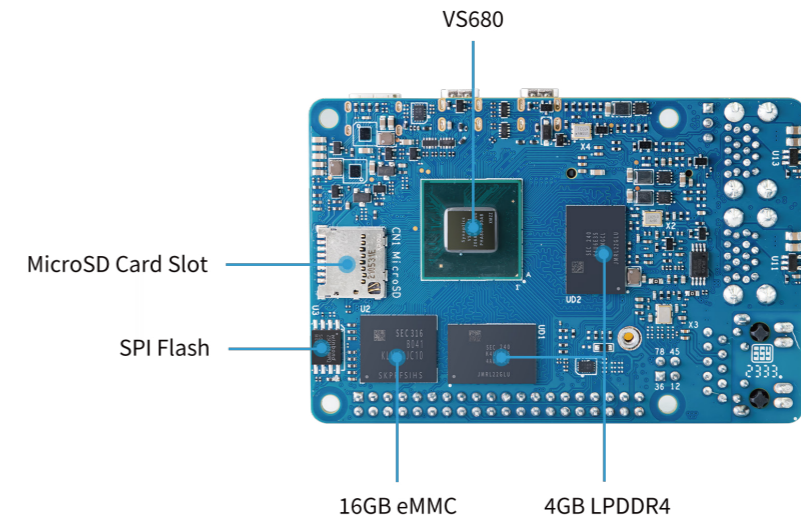
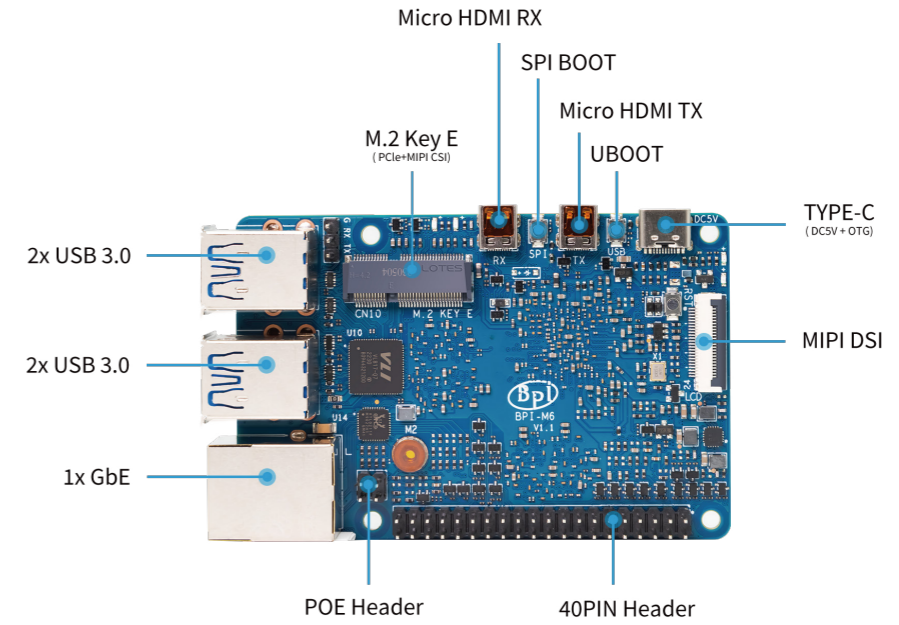
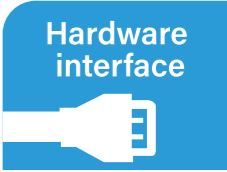

- Synaptics VideoSmart VS680 quad-core Cortex-A73 (2.1GHz) and One Cortex-M3 processor
- Imagination GE9920 GPU
- 4GB LPDDR4
- 16GB eMMC flash
- M.2 Key E(PCIe + MIPI CSI)
- 4xUSB 3.0
- 1xGbE Ethernet
- 1xHDMI in and 1xHDMI out



Banana Pi BPI-P2 Pro

 Rockchip RK3308B-S	 Quad-core 64-Bit SOC
 8GB eMMC	 512MB DDR3

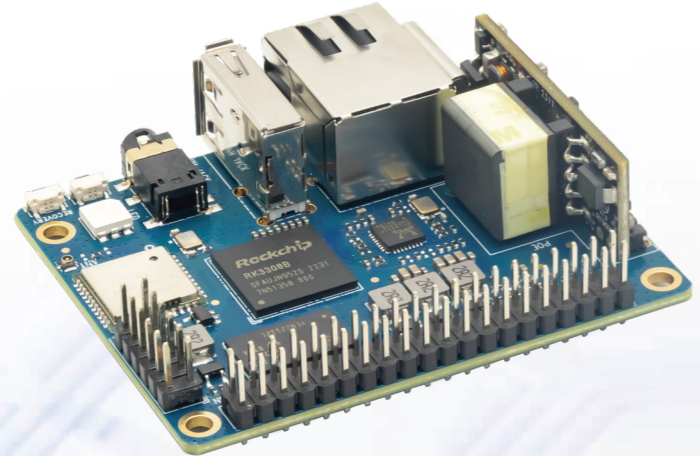

- Rockchip RK3308B-S, Quad-core Cortex-A35, 64-Bit SOC
- 512MB DDR3 SDRAM
- 8GB eMMC
- Wi-Fi & BT(AP6256) onboard
- 12PIN Header, It includes UART, SPI, I2C, IO etc
- 40PIN Header, It includes I2S, MIC, ADC etc
- 100M LAN
- IEEE 802.3af PoE standard PoE module support

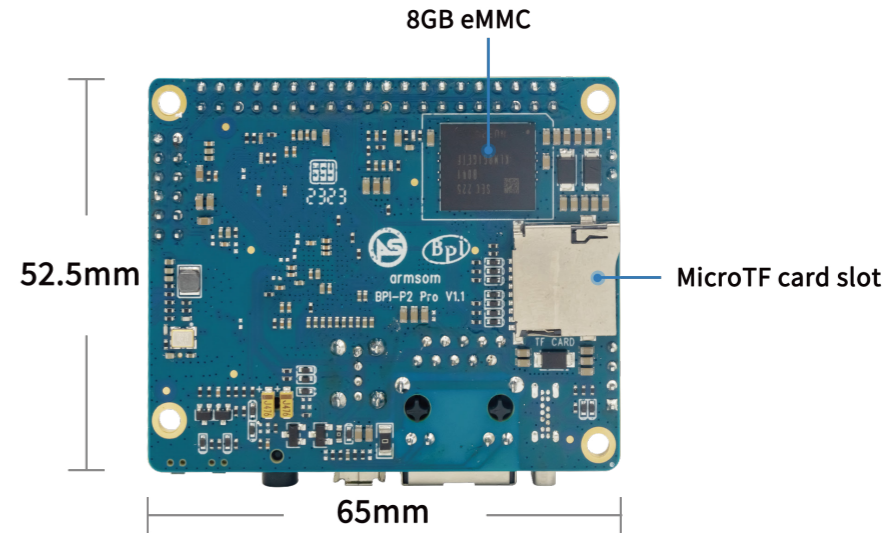
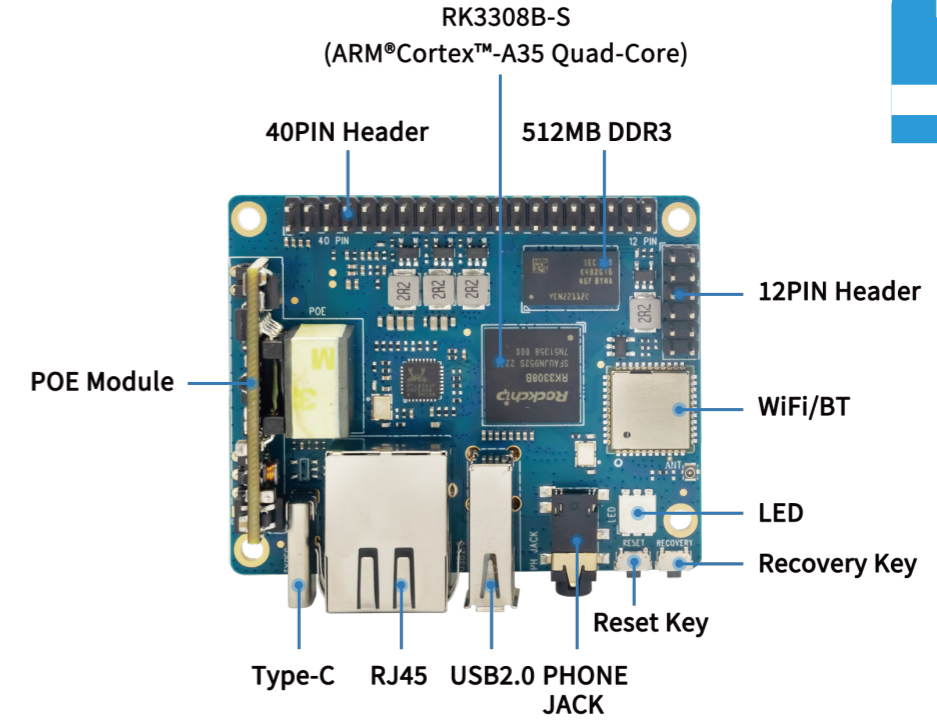
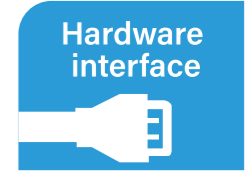

Banana Pi BPI-R2 PRO



2GB LPDDR4

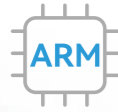

Quad-core
64-Bit SOC



16GB eMMC



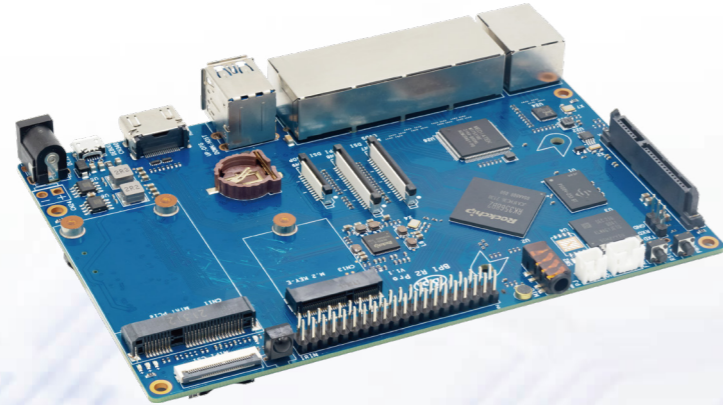

Gigabit Ethernet

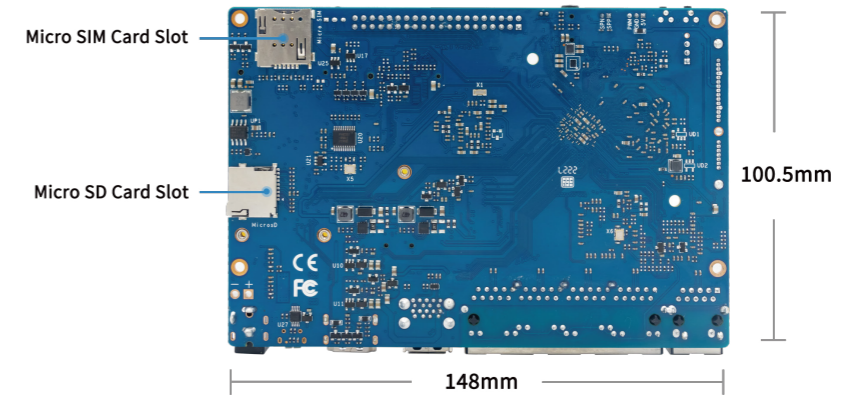
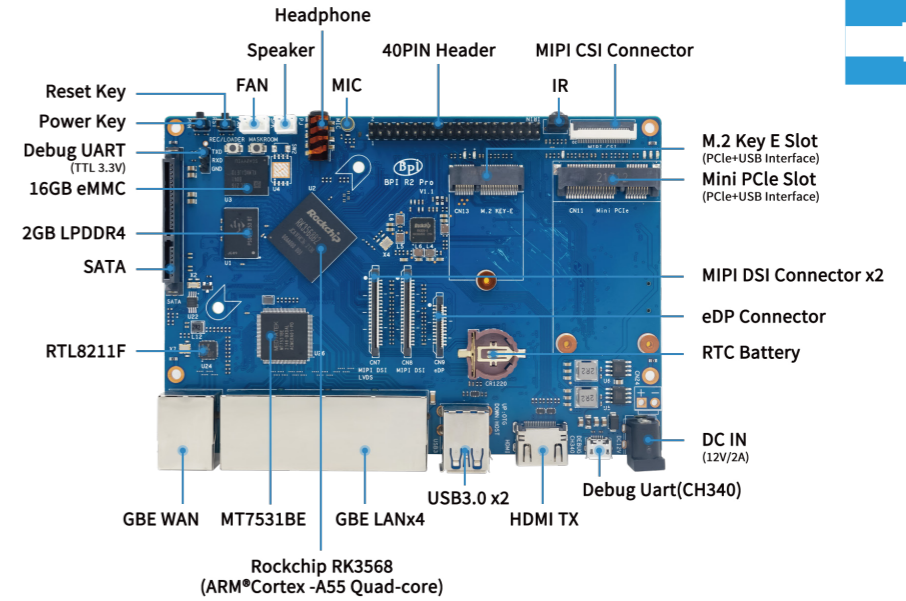

- Rockchip RK3568, Quad-core Cortex-A55, 64 bit SOC
- Mali-G52 1-Core-2EE
- 2GB LPDDR4 SDRAM
- 16GB eMMC
- Mini PCIE Slot and M.2 KEY-E PCIe Slot
- MicroSD Slot
- 1x eDP connector
- 2x MIPI display connector
- 5x 10/100/1000mbps Ethernet RJ45
- 1x SATA Slot
- 1x MIPI CSI connector
- 2x USB 3.0
- 12V 2A DC IN

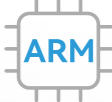

Banana Pi BPI-W3

-  Rockchip RK3588
-  Octa-core 64-Bit SOC
-  32GB eMMC
-  2.5Gbps Ethernet

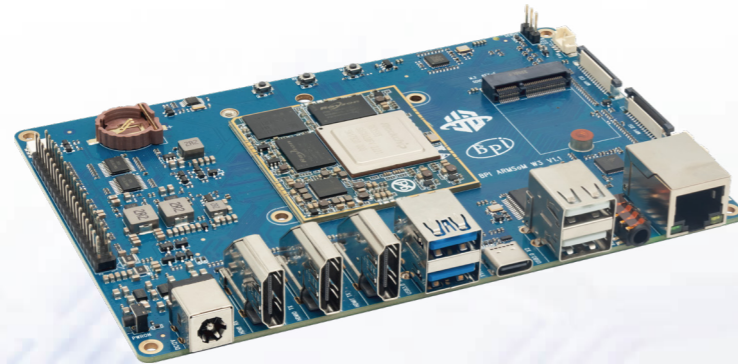

- Rockchip RK3588 quad ARM Cortex-A76 and quad Cortex-A55 consists of an eight-core CPU processor
- ARM Mali-G610 MP4
- NPU for AI : 6Tops@INT8
- 8GB LPDDR4X SDRAM and 32GB eMMC onboard
- 2.5Gbps Ethernet
- Support HDMI in and HDMI out * 2
- 12V 2A DC IN

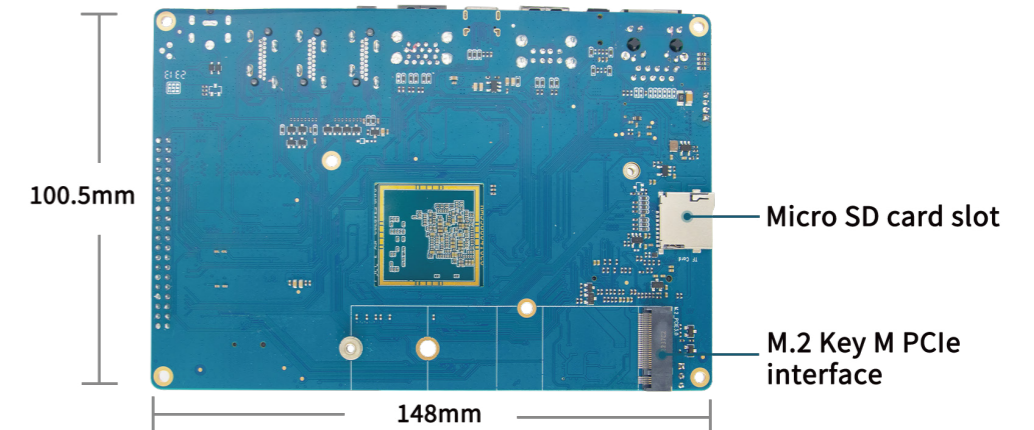
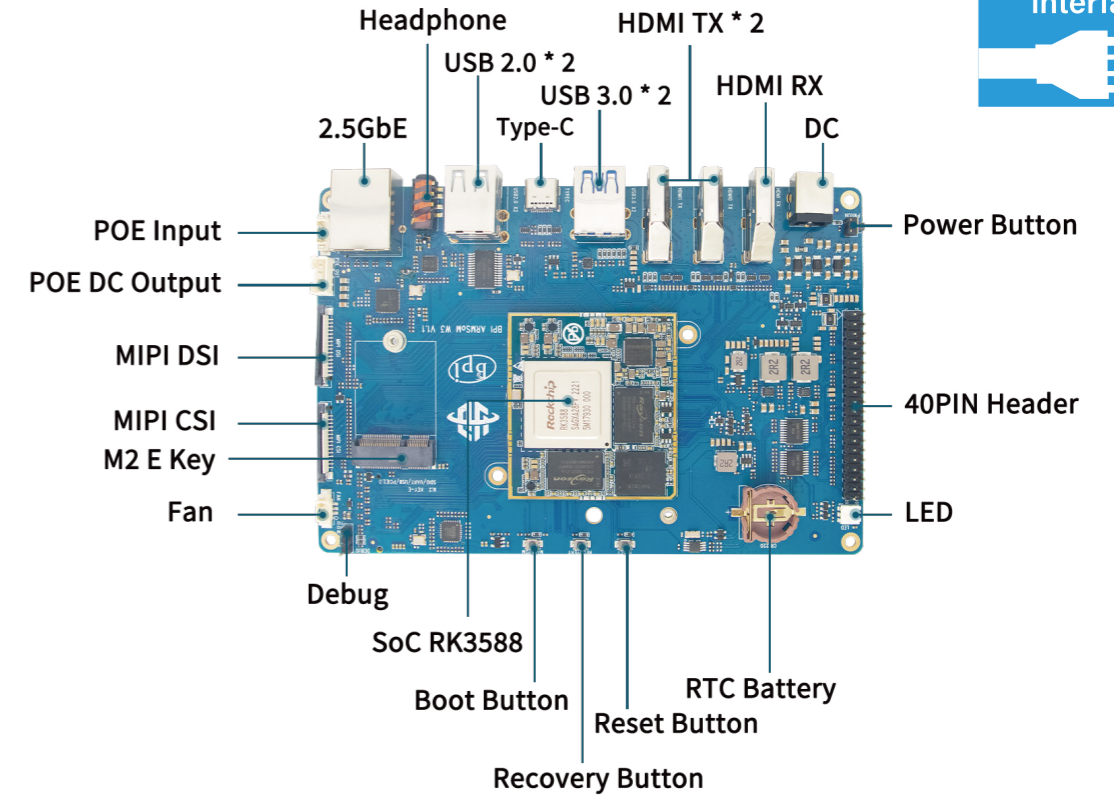

Banana Pi BPI-W2

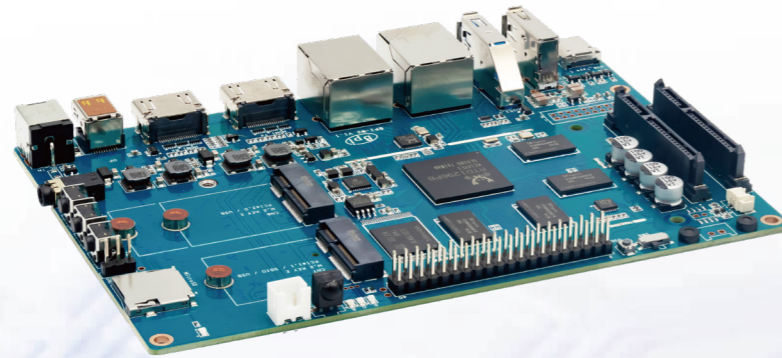
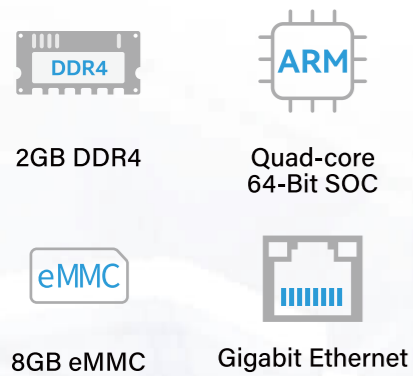

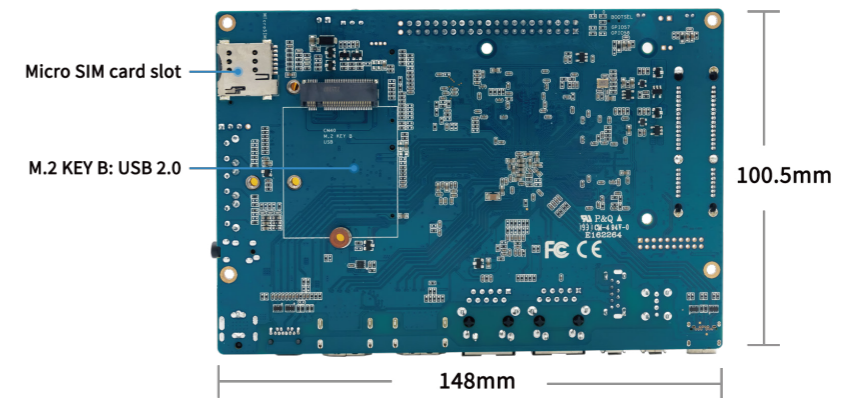
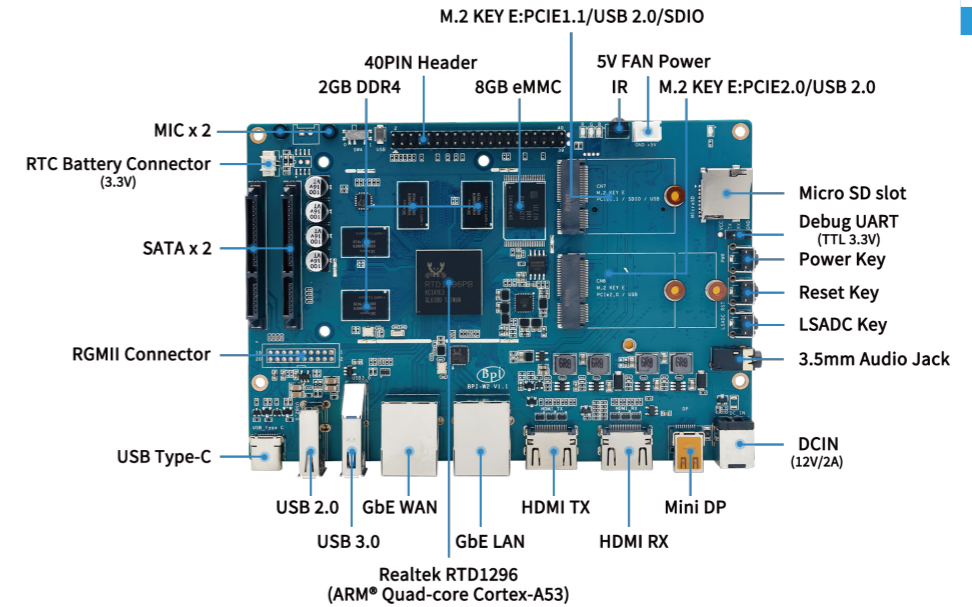
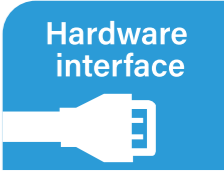

- Realtek RTD1296, Quad-core Cortex-A53, 64-Bit SOC
- Mali T820 MP3 GPU
- 2GB DDR4 SDRAM
- 8GB eMMC flash
- 1xGbE WAN, 1xGbE LAN
- Mini PCIE 2.0, 1.1 interface, SDIO, M.2 interface
- 1xUSB 3.0, 2xUSB 2.0
- Mini DP

- MIC in/Audio out
- SATA interface
- 40PIN Header
- 1x HDMI2.0 receiver
- 1x HDMI2.0 transmitter
- 12V 2A DC IN

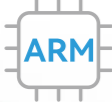

Banana Pi BPI-F2P

 512MB DDR3
 Quad-core 32-Bit SOC
 8GB eMMC
 Gigabit Ethernet

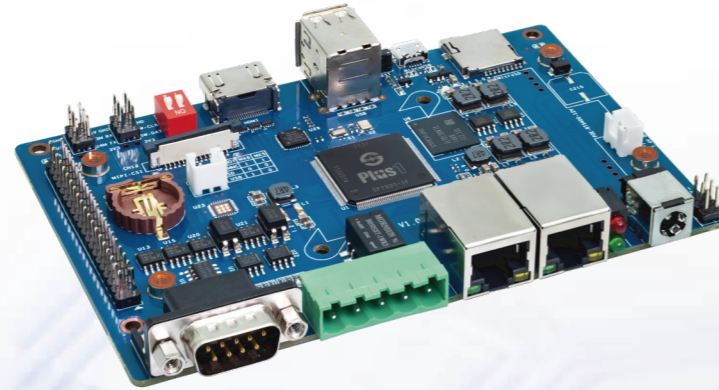

- Easy-to-use LQFP package
- Quad-core 1GHz Cortex-A7 CPU, plus A926 and 8051 cores
- Single 3.3V power
- Integrated 128MB or 512MB DDR3 DRAM
- Eight 8-bit 5V-tolerant IO ports, plus one high-current port
- Flexible Peripheral Multiplexing (PinMux)
- Dual PinMuxable Ethernet MACs
- Four PinMuxable Enhanced UARTs, plus one console UART
- Modern, Yocto-based Linux distribution
- Low EMI simplifies certification

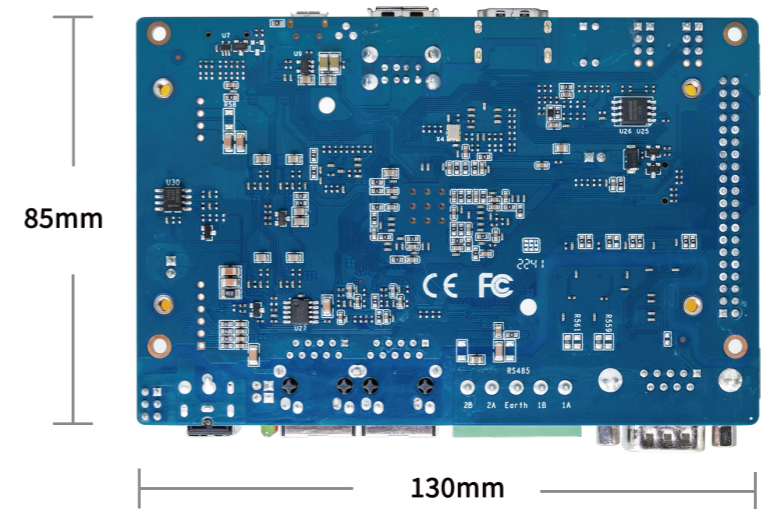
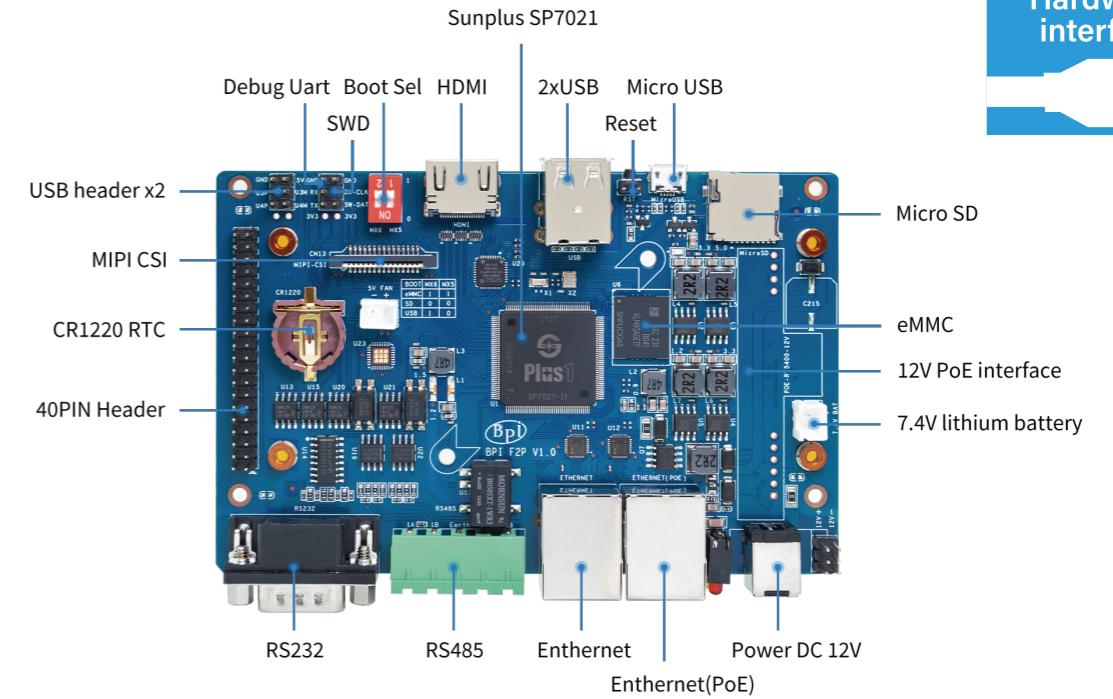

STEAM education series development board



size
LCD

Banana Pi BPI-Centi-S3

ESP32-S3, Xtensa 32 bit LX7, 2M PSRAM, 8M FLASH
2.4G WIFI Bluetooth 5, Bluetooth mesh, 1*ST7789 TFT LCD,
1.9-inch 170*320 resolution, 8bit 8080 parallel port
2*SH-1.0 6-pin slot, 1*SH-1.0 4-pin slot
1*Rotary Encoder, 1*Buzzer, 1* RGB LED

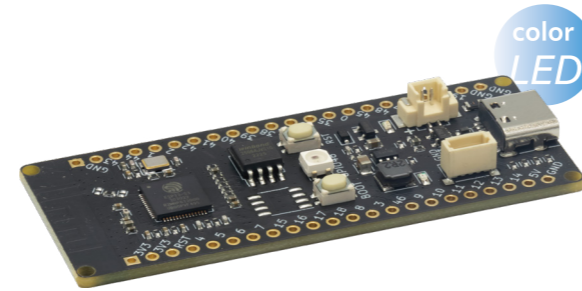

color
LED

Banana Pi BPI-Leaf-S3

ESP32-S3, Xtensa 32 bit LX7, 2M PSRAM, 8M FLASH
2.4G WIFI, Bluetooth 5, Bluetooth mesh
1*SH-1.0 4-pin slot,
1*USB Type-C
1*MX-1.25 lithium battery slot, support USB charging
1* RGB LED

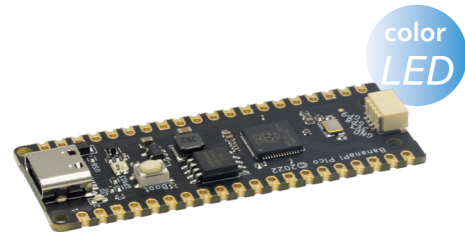

color
LED

Banana Pi BPI-Pico-RP2040

RP2040, Arm Cortex M0+, 264KB SRAM, 2MB FLASH
1*SH-1.0 4-pin slot
1*USB Type-C, 1*RGB LED

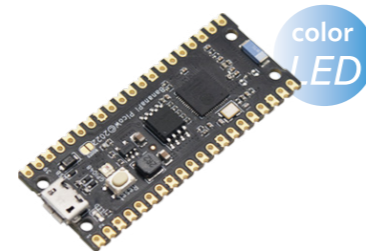

color
LED

Banana Pi BPI-PicoW-S3

ESP32-S3, Xtensa 32 bit LX7, 2M PSRAM, 8M FLASH
2.4G WIFI, Bluetooth 5, Bluetooth mesh
1*MicroUSB, 1*RGB LED

What can I do with Banana Pi products



Smart Display Devices

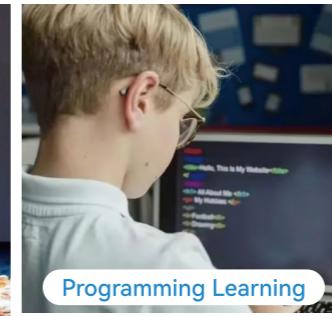

Programming Learning



Intelligent security



Smart Home



Multimedia application

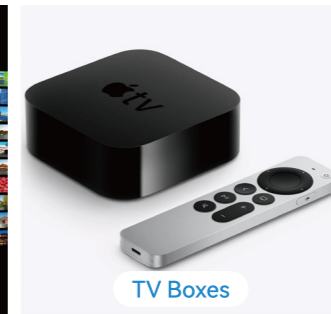

TV Boxes

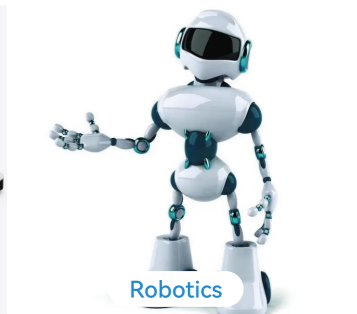

Robotics

YOU CAN USE IT TO BUILD



Smart Gateway

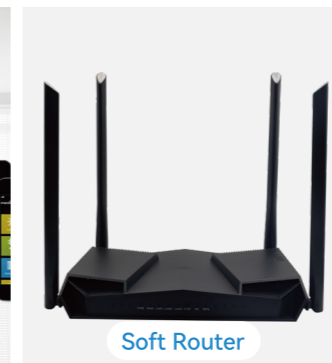

Soft Router



Internet of Things

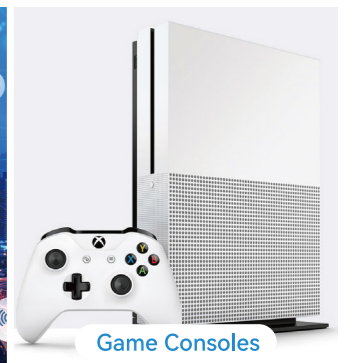

Game Consoles

WHAT CAN WE DO/ODM&OEM



CUSTOMIZATION

We will help you optimize and design



SAMPLE

We will help you bring it to live



SUPPLY

We will help you mass produce it



Dream

,

It

► *Comes out*

step by step

X-ON Electronics

Largest Supplier of Electrical and Electronic Components

Click to view similar products for [Single Board Computers](#) category:

Click to view products by [Sinovoip](#) manufacturer:

Other Similar products are found below :

[MVME61006E-2173R](#) [5962-8872609LA](#) [BLKNUC7I3DNHNC1978015](#) [IOT-LS1012A-OXALIS](#) [NITX-300-ET-DVI](#) [UPN-EHLX4E-A10-0432](#) [USB HUB HAT](#) [BANANA PI BPI-P2 PRO](#) [ROCK 4C+](#) [ROCK 5B - 8GB](#) [BANANA PI BPI-CM4](#) [BPI-R2 PRO](#) [UP-APL03C2F-A10-0232](#) [HUMMINGBOARD-I2EX BASE + WIFI/BT](#) [HUMMINGBOARD-I4 PRO + WIFI/BT](#) [VAB-600-B](#) [MITX-440-DVI-2E](#) [NITX-315-DEVKIT](#) [A13-SOM-512](#) [AM3359-SOM-EVB-IND](#) [1996](#) [AIMB-223G2-S0A1E](#) [AIMB-562VG-GRA1E](#) [MIO-5270DZ-2GS0A1E](#) [PCE-5126QVG-00A1E](#) [PCE-5125QG2-00A1E](#) [MIO-5251E-S3A1E](#) [MIO-2261Z-2GS6A1E](#) [SIMB-M22-2G2S0A1E](#) [ASMB-823I-00A1E](#) [MIO-5251J-U0A1E](#) [AIMB-502WG2-00A1E](#) [BBB01-SC-505](#) [IMB-M43](#) [AmITX-BT-I-E3845](#) [UPS-APLC2-A10-0432](#) [PICO300VGA-N3060](#) [PICO300HGA-N3710](#) [W65C265QBX](#) [DFR0444](#) [DFR0419](#) [UPS-APLP4-A10-0864](#) [UPS-APLP4-A10-0432](#) [UPS-APLP4-A10-08128](#) [DFR0418](#) [BBBLUE](#) [IB811F-I30](#) [DFR0546](#) [Nit6Q_i](#) [M2M \(TELIT\)](#)