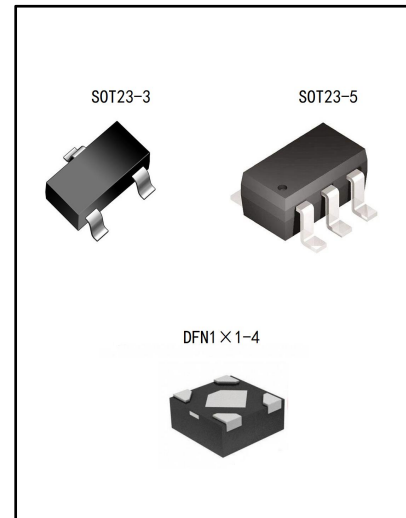

Input voltage 8V Current 400mA Voltage Regulator**SSP7615****General Description**

The SSP7615 is a high accuracy, low noise, high speed CMOS Linear regulator with low power consumption and low dropout voltage, which provide large output currents even when the difference of the input-output voltage is small. The devices offer a new level of cost effective performance in cellular phones, laptop and notebook computers, and other portable devices.

The current limiter's fold-back circuit also operates as a short circuit protection and an output current limiter at the output pin.

The SSP7615 regulators are available in standard SOT23-3, SOT23-5 and DFN1×1-4 packages. Standard products are Pb-free and Halogen-free.

**Features**

- Input voltage:1.5V~8V
- Output range:1.2V~5.0V
- Maximum output current: 400mA @ VOUT=3.3V
- PSRR: 60dB @1KHz
- Dropout voltage:200mV @ IOUT=100mA
- Quiescent current: 0.5μA Typ.
- Shut-down current: <1μA
- Recommend capacitor:1μF
- Built-in Short-Circuit Protection, Current Limiter

Applications

- Radio control systems
- Cellphones, radiophone, digital cameras
- Bluetooth, wireless handsets
- Others portable consumer equipments

Order specification

Part No	Package	Manner of Packing	Devices per bag/reel
SSP7615-XXMR	SOT23-3	Reel	3000PCS/REEL
SSP7615-XXM5R	SOT23-5	Reel	3000PCS/REEL
SSP7615-XXDFR	DFN1×1-4	Reel	10000PCS/REEL

Note: XX indicates 1.2V~5.0V by 0.1V step. For example, 33 means product outputs 3.3V

Type selection guide

SSP7615-①②③④⑤

Designator	Symbol	Description
①②	Integer	Output Voltage(1.2~5.0V)
③④	M	Package:SOT23-3
	M5	Package:SOT23-5
	DF	Package: DFN1×1-4
⑤	R	RoHS / Pb Free
	G	Halogen Free

Block Diagram

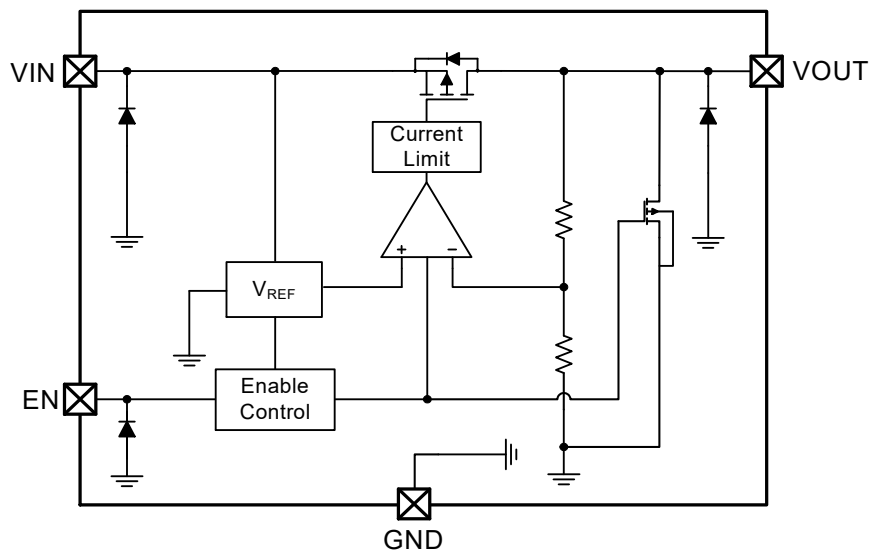

Pin Assignment

SOT23-3 (Top View)

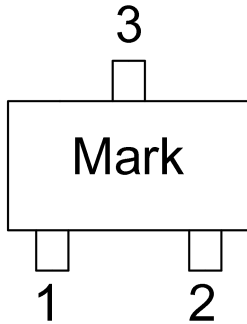

Table 1: SSP7615-XXMR series (SOT23-3 PKG)

PIN NO.	PIN NAME	FUNCTION
1	GND	GND pin
2	VOUT	Output voltage pin
3	VIN	Input voltage pin

SOT23-5 (Top View)

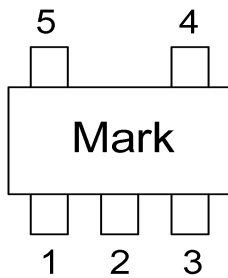

Table 2: SSP7615-XXM5R series (SOT23-5 PKG)

PIN NO.	PIN NAME	FUNCTION
1	VIN	Input
2	GND	Ground
3	EN	Enable(Active high, not floating)
4	NC	Not connected
5	VOUT	Output

DFN1×1-4 (Top View)

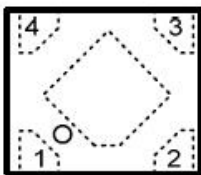

Table 3: SSP7615-XXDFR series (DFN1×1-4 PKG)

PIN NO.	PIN NAME	FUNCTION
1	VOUT	Output
2	GND	Ground
3	EN	Enable(Active high, not floating)
4	VIN	Input

Functional Description

The SSP7615 is a high accuracy, low noise, high speed CMOS Linear regulator with low power consumption and low dropout voltage, which provide large output currents even when the difference of the input-output voltage is small.

Absolute Maximum Ratings

Parameter	Symbol	Value	Unit
Input Voltage	V_{IN}	-0.3~8	V
Max Output Current	I_{OUT}	450	mA
Operating Temperature	T_{opr}	-40~85	°C
Storage Temperature	T_{stg}	-55~150	°C
Package Lead Soldering Temperature	T_{sol}	260	°C
Junction Temperature	T_j	-40~125	°C

Note: These are stress ratings only. Stresses exceeding the range specified under “Absolute Maximum Ratings” may cause substantial damage to the device. Functional operation of this device at other conditions beyond those listed in the specification is not implied and prolonged exposure to extreme conditions may affect device reliability.

Thermal Information

Parameter	Symbol	Package	Max.	Unit
Thermal Resistance (Junction to Ambient) (Assume no ambient airflow, no heat sink)	θ_{JA}	SOT23-3	500	°C/W
		SOT23-5	500	°C/W
		DFN1×1-4	200	°C/W
Power Dissipation	P_D	SOT23-3	0.40	W
		SOT23-5	0.40	W
		DFN1×1-4	0.40	W

Note: P_D is measured at $T_a = 25^\circ\text{C}$

Electrical Characteristics

The following specifications apply for $V_{OUT} = 3.3V$, $T_A = 25^\circ C$, unless specified otherwise.

Parameter	Symbol	Test Conditions	Min.	Typ.	Max.	Unit
Input Voltage	V_{IN}		1.5	--	8	V
Output Range	V_{OUT}	$I_{OUT} = 1mA$	-2	V_{OUT}	2	%
Quiescent Current	I_Q	$V_{OUT} = 3.3V, I_{OUT} = 0$	--	0.45	--	μA
Current Limit	I_{LIMIT}	$V_{IN} = V_{EN} = 4.5V$	--	400	--	mA
Dropout Voltage	V_{DROP}	$V_{OUT} = 3.3V, I_{OUT} = 100mA$	--	200	--	mV
		$V_{OUT} = 3.3V, I_{OUT} = 200mA$	--	400	--	mV
Line Regulation	ΔV_{LINE}	$V_{IN} = 2.7 \sim 5.5V, I_{OUT} = 1mA$	--	0.01	0.15	%/V
Load Regulation	ΔV_{LOAD}	$V_{OUT} = 3.3V, I_{OUT} = 1 \sim 300mA$	--	200	--	mV
Short Current	I_{SHORT}	$V_{EN} = V_{IN}, V_{OUT}$ Short to GND with 1Ω	--	35	--	mA
Shut-down Current	I_{SHDN}	$V_{EN} = 0V$	--	--	1	μA
Power Supply Rejection Rate	PSRR	$V_{IN} = 5V_{DC} + 0.5V_{P-P}$ $F = 1KHz, I_{OUT} = 10mA$		60		dB
EN logic high voltage	V_{ENH}	$V_{IN} = 5.5V, I_{OUT} = 1mA$	1.2	--	V_{IN}	V
EN logic low voltage	V_{ENL}	$V_{IN} = 5.5V, V_{OUT} = 0V$	--	--	0.4	V
EN Input Current	I_{EN}	$V_{EN} = 0$ to $5.5V$	--	--	1	μA

Application Circuits

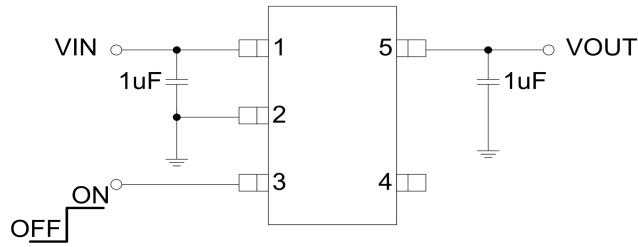

Typical Performance Characteristics

$C_{IN}=1\mu F, C_{OUT}=1\mu F, V_{IN}=4.5V, V_{OUT}=3.3V, SOT23-5, T_A=25^\circ C$

(unless specified otherwise. Package: SOT23-5L)

(1) Quiescent current vs Input voltage

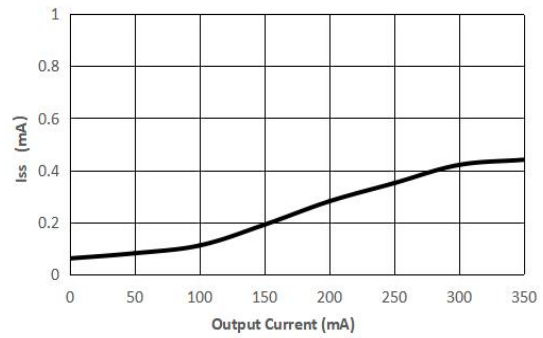
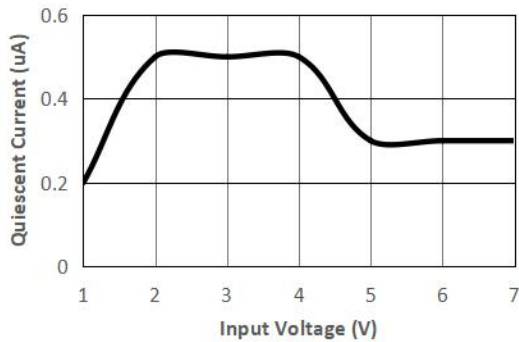

(2) Output Voltage vs Input voltage

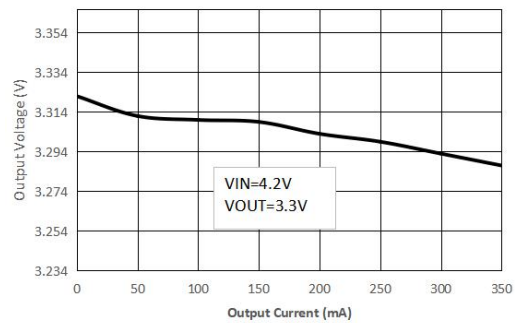
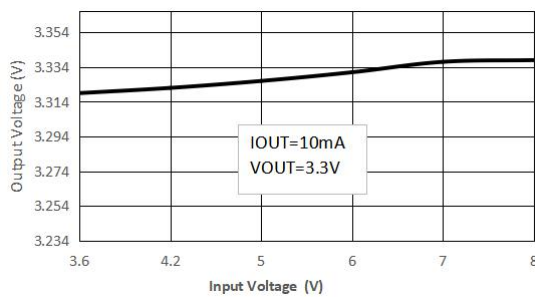

(3) PSRR vs Frequency

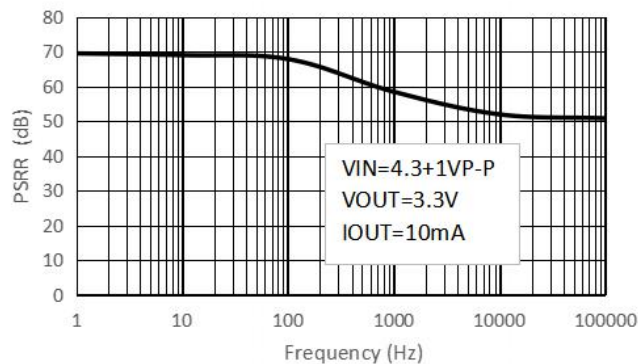

Power ON / OFF

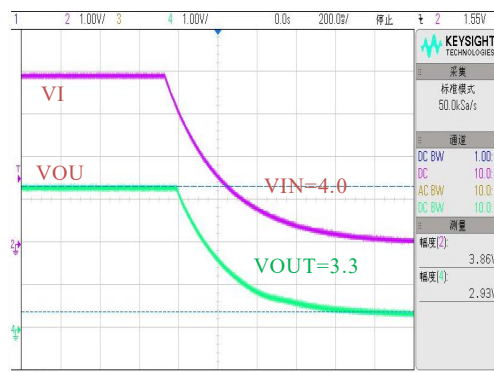
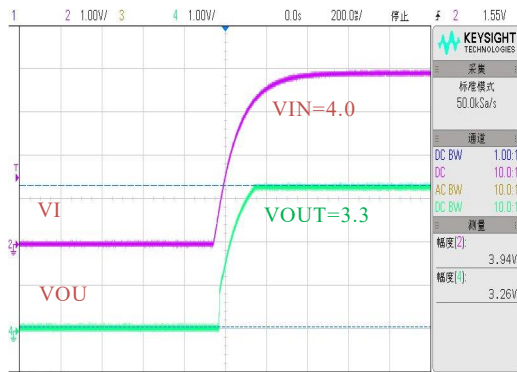

EN ON/OFF

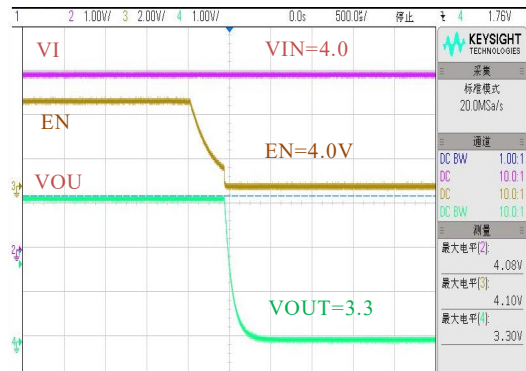
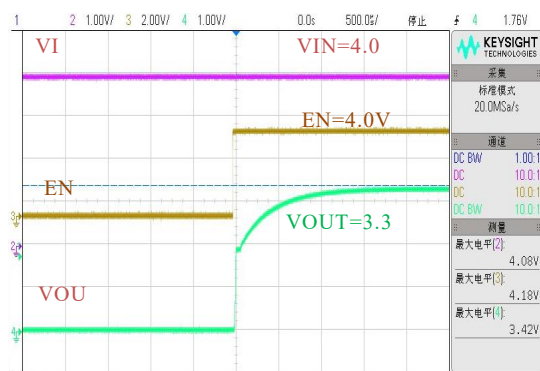

Line Transient

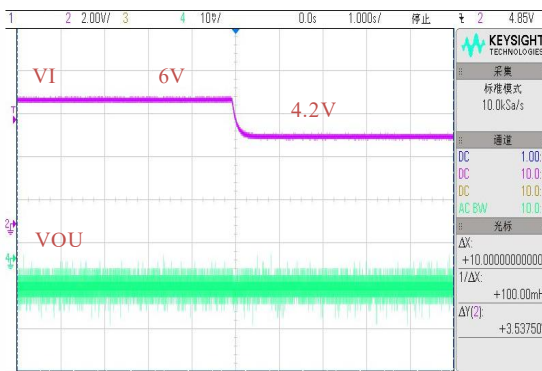
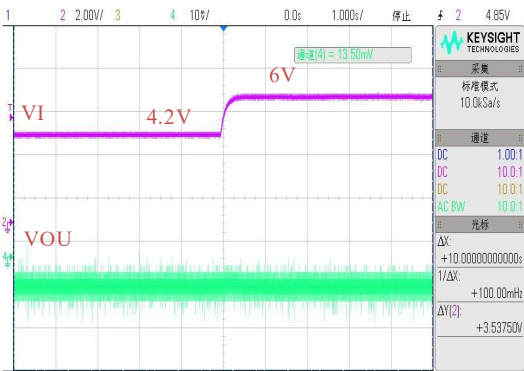

Load Transient

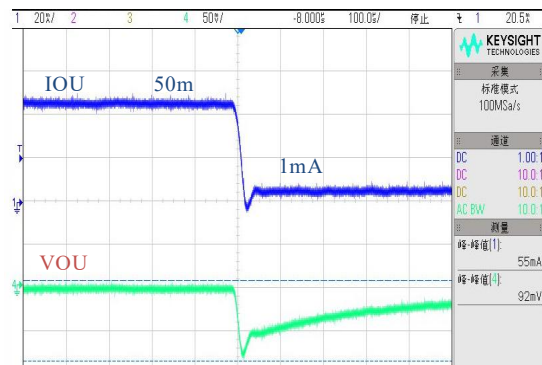
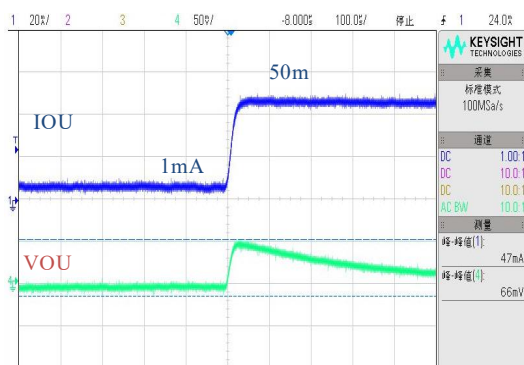

Application Information

In general, all the capacitors need to be low leakage. Any leakage the capacitors have will reduce efficiency, increase the quiescent current.

A recent trend in the design of portable devices has been to use ceramic capacitors to filter DC-DC converter inputs. Ceramic capacitors are often chosen because of their small size, low equivalent series resistance (ESR) and high RMS current capability. Also, recently, designers have been looking to ceramic capacitors due to shortages of tantalum capacitors.

Unfortunately, using ceramic capacitors for input filtering can cause problems. Applying a voltage step to a ceramic capacitor causes a large current surge that stores energy in the inductance of the power leads. A large voltage spike is created when the stored energy is transferred from these inductance into the ceramic capacitor. These voltage spikes can easily be twice the amplitude of the input voltage step.

Many types of capacitors can be used for input bypassing, however, caution must be exercised when using multi layer ceramic capacitors (MLCC). Because of the self-resonant be generated under some start-up conditions, such as connecting the LDO input to a live power source.

The LDO also requires an output capacitor for loop stability. Connect a 1uF tantalum capacitor from OUT to GND close to the pins. For improved transient response, this output capacitor may be ceramic.

Marking Description

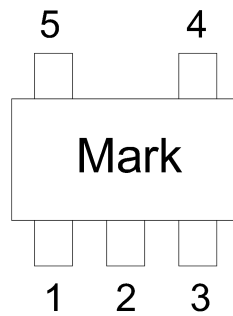

- ① product code: 4
 ② output voltage code:

Symbol	Voltage (V)	Symbol	Voltage (V)	Symbol	Voltage (V)	Symbol	Voltage (V)
a	0.9	A	3.5	n	2.2	N	4.8
b	1.0	B	3.6	o	2.3	O	4.9
c	1.1	C	3.7	P	2.4	P	5.0
d	1.2	D	3.8	q	2.5	Q	5.1
e	1.3	E	3.9	r	2.6	R	5.2
f	1.4	F	4.0	s	2.7	S	5.3
g	1.5	G	4.1	t	2.8	T	5.4
h	1.6	H	4.2	u	2.9	U	5.5
i	1.7	I	4.3	v	3.0	V	5.6
j	1.8	J	4.4	w	3.1	W	5.7
k	1.9	K	4.5	x	3.2	X	5.8
l	2.0	L	4.6	y	3.3	Y	5.9
m	2.1	M	4.7	z	3.4	Z	6.0

③④: The last two of them are based on the time of this product which is the first time into production, the third is the year of this product first time into production, such as expressed in "1" in 2021, in "2" in 2022 and the fourth is the month of this product first time into production, it can be in 1 ~ 9, which is expressed in "0" in October, in November with an "A", in December with "B"; . For example: 4y16 represents SSP7615-33M5R product is first put into production in June in 2021.

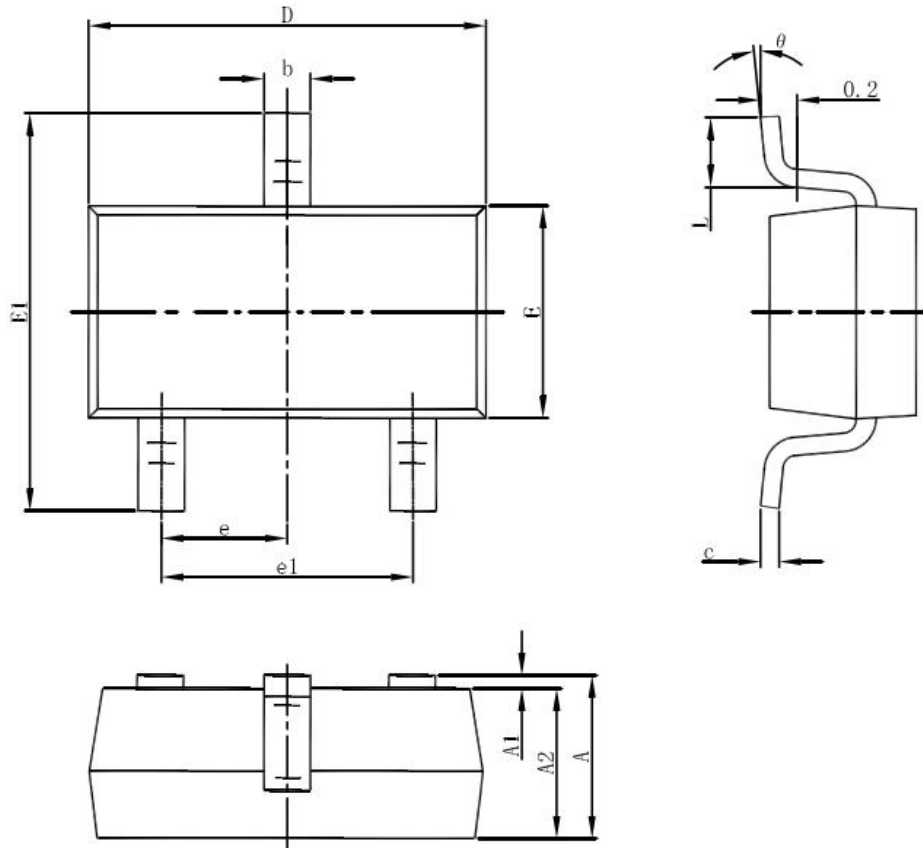
Package Information (SOT23-3)

Symbol	Dimensions In Millimeters		Dimensions In Inches	
	Min.	Max.	Min.	Max.
A	1.050	1.250	0.041	0.049
A1	0.000	0.100	0.000	0.004
A2	1.050	1.150	0.041	0.045
b	0.300	0.500	0.012	0.020
c	0.100	0.200	0.004	0.008
D	2.820	3.020	0.111	0.119
E	1.500	1.700	0.059	0.067
E1	2.650	2.950	0.104	0.116
e	0.950(BSC)		0.037(BSC)	
e1	1.800	2.000	0.071	0.079
L	0.300	0.600	0.012	0.024
θ	0°	8°	0°	8°

Package Information (SOT23-5)

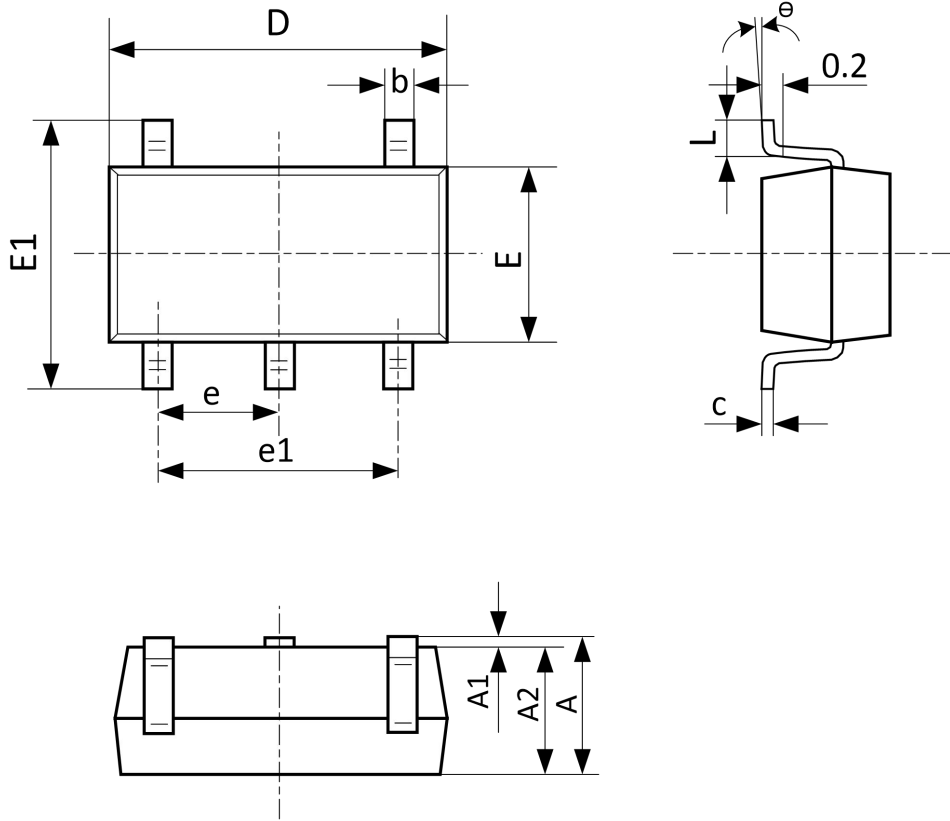

Symbol	Dimensions In Millimeters		Dimensions In Inches	
	Min.	Max.	Min.	Max.
A	1.050	1.250	0.041	0.049
A1	0.000	0.100	0.000	0.004
A2	1.050	1.150	0.041	0.045
b	0.300	0.500	0.012	0.020
c	0.100	0.200	0.004	0.008
D	2.820	3.020	0.111	0.119
E	1.500	1.700	0.059	0.067
E1	2.650	2.950	0.104	0.116
e	0.950(BSC)		0.037(BSC)	
e1	1.800	2.000	0.071	0.079
L	0.300	0.600	0.012	0.024
θ	0°	8°	0°	8°

Package Information (DFN1×1-4)

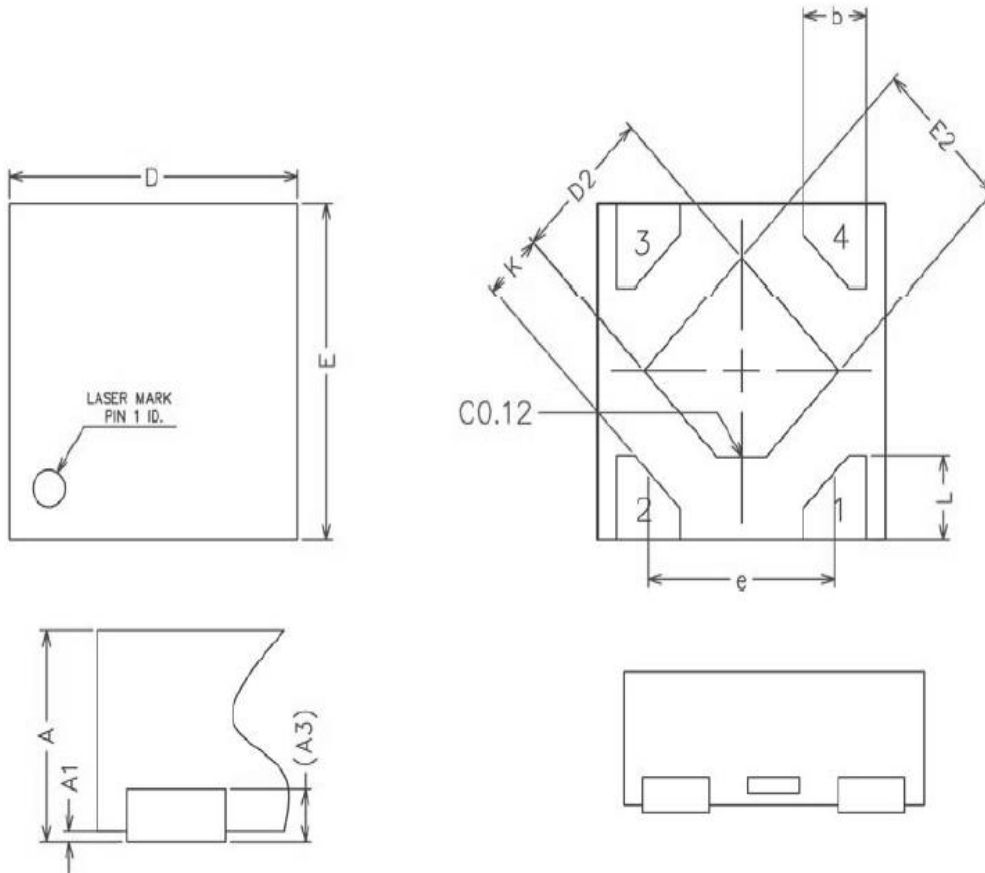

Symbol	Dimensions In Millimeters		
	Min.	NOM	Max.
A	0.34	0.37	0.40
A1	0.00	0.02	0.05
A3	0.100REF		
b	0.17	0.22	0.27
D	0.95	1.00	1.05
E	0.95	1.00	1.05
D2	0.43	0.48	0.53
E2	0.43	0.48	0.53
L	0.20	0.25	0.30
e	-	0.65	-
K	0.15	-	-

Special Instructions

The company reserves the right of final interpretation of this specification.

Version Change Description

Version: V1.2	Author: Yangyang	Time: 2021.12.9
---------------	------------------	-----------------

Modify the record:

1. Re-typesetting the manual and checking some data
-

Version: V1.3	Author: Yangyang	Time: 2022.3.30
---------------	------------------	-----------------

Modify the record:

1. Update absolute maximum ratings and electrical characteristics
-

Statement

The information in the usage specification is correct at the time of publication, Shanghai Siproin Microelectronics Co. has the right to change and interpret the specification, and reserves the right to modify the product without prior notice. Users can obtain the latest version information from our official website or other effective channels before confirmation, and verify whether the relevant information is complete and up to date.

With any semiconductor product, there is a certain possibility of failure or failure under certain conditions. The buyer is responsible for complying with safety standards and taking safety measures when using the product for system design and complete machine manufacturing. The product is not authorized to be used as a critical component in life-saving or life-sustaining products or systems, in order to avoid potential failure risks that may cause personal injury or property loss.

X-ON Electronics

Largest Supplier of Electrical and Electronic Components

Click to view similar products for [Linear Voltage Regulators](#) category:

Click to view products by [Siproin](#) manufacturer:

Other Similar products are found below :

[LV5684PVD-XH](#) [MCDTSA6-2R](#) [L7815ACV-DG](#) [714954EB](#) [ZMR500QFTA](#) [BA033LBSG2-TR](#) [LV5680P-E](#) [L79M05T-E](#) [L78LR05D-MA-E](#) [NCV317MBTG](#) [NTE7227](#) [MP2018GZD-33-P](#) [MP2018GZD-5-P](#) [LV5680NPVC-XH](#) [LT1054CN8](#) [ZTS6538SE](#) [UA78L09CLP](#) [UA78L09CLPR](#) [CAT6221-PPTD-GT3](#) [MC78M09CDTRK](#) [NCV51190MNTAG](#) [78M05](#) [HT7150-1](#) [UM1540DB-18](#) [XC6234H281VR-G](#) [WL2834CA-6/TR](#) [TPL730F33-5TR](#) [TLS850F1TA](#) [V50](#) [TPS549B22RVFR](#) [UM1540DB-33](#) [WL9200P3-50B](#) [WL9100P3-33B](#) [WL9005D4-33](#) [XC6219B152MR](#) [WL2855K33-3/TR](#) [PJ54BM33SE](#) [PJ9500M25SA](#) [MD7218E33PC1](#) [H7533-2PR](#) [SK7812AU](#) [SD1A30](#) [78L33](#) [TP78L33T3](#) [L78L33ACUTR](#) [SK6513ST3A-50](#) [SK6054D4-09](#) [SK6054D4-18](#) [SK6054D4-11](#) [SK6054D4-10](#) [LM79L12F](#)