

SBTA41G04B thru SBTA41G16B

Discrete Triacs (Isolated)

T1

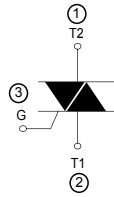

Unit:mm

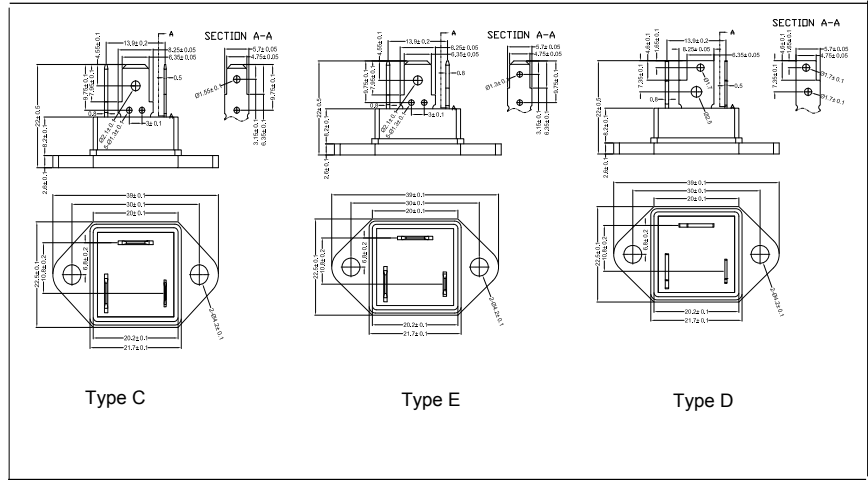

	VDRM/RRM	VDSM/RSM
	V	V
SBTA41G04B	400	500
SBTA41G06B	600	700
SBTA41G08B	800	900
SBTA41G10B	1000	1100
SBTA41G12B	1200	1300
SBTA41G16B	1600	1700

Symbol	Test Conditions	Maximum Ratings	Unit
I_{TRMS}	$T_{VJ}=80^{\circ}C$	40	A
I_{TSM}	$T_{VJ}=45^{\circ}C$ $V_R=0$ $t=10ms$ (50Hz), sine $t=8.3ms$ (60Hz), sine	420 400	A
	$T_{VJ}=T_{VJM}$ $V_R=0$ $t=10ms$ (50Hz), sine $t=8.3ms$ (60Hz), sine	350 320	
i^2t	$T_{VJ}=45^{\circ}C$ $V_R=0$ $t=10ms$ (50Hz), sine $t=8.3ms$ (60Hz), sine	880 850	A^2s
	$T_{VJ}=T_{VJM}$ $V_R=0$ $t=10ms$ (50Hz), sine $t=8.3ms$ (60Hz), sine	760 720	
$(di/dt)_{cr}$	$T_{VJ}=T_{VJM}$ $f=50Hz$, $t_p=200\mu s$ $V_D=2/3V_{DRM}$ $I_G=0.3A$ $di_G/dt=0.3A/\mu s$	repetitive, $I_T=40A$ 50 non repetitive, $I_T=I_{TAVM}$ 300	$A/\mu s$
	$T_{VJ}=T_{VJM}$; $R_{GK}=\infty$; method 1 (linear voltage rise)	$V_{DR}=2/3V_{DRM}$ 500	$V/\mu s$
P_{GM}	$T_{VJ}=T_{VJM}$ $I_T=I_{TAVM}$ $t_p=30\mu s$ $t_p=300\mu s$	10 5	W
$P_{GA V}$		1	W
V_{RGM}		10	V
T_{VJ} T_{VJM} T_{stg}		-40...+125 125 -40...+125	$^{\circ}C$
V_{ISOL}	50/60Hz, RMS $t=1$ minute, leads-to-tab	2500	V~
M_d	Mounting torque (M4)	0.8...1.5	Nm
Weight		25	g

SBTA41G04B thru SBTA41G16B

Discrete Triacs(Isolated)

Symbol	Test Conditions	Characteristic Values	Unit				
I_R, I_D	$T_{VJ}=T_{VJM}; V_D=V_{DRM}$	10	mA				
V_{TM}	$I_T=60A; T_{VJ}=25^{\circ}C$	1.44	V				
V_{TO}	For power-loss calculations only ($T_{VJ}=125^{\circ}C$)	0.85	V				
r_T		10	Ω				
V_{GT}	<table border="1"> <tr><td>I</td></tr> <tr><td>II</td></tr> <tr><td>III</td></tr> <tr><td>IV</td></tr> </table> $V_D=6V; I_T=1A; T_{VJ}=25^{\circ}C$	I	II	III	IV	1.3	V
		I					
		II					
		III					
IV							
1.3							
1.3							
1.5							
I_{GT}	<table border="1"> <tr><td>I</td></tr> <tr><td>II</td></tr> <tr><td>III</td></tr> <tr><td>IV</td></tr> </table> $V_D=6V; I_T=1A; T_{VJ}=25^{\circ}C$	I	II	III	IV	50	mA
		I					
		II					
		III					
IV							
50							
50							
100							
V_{GD}	$T_{VJ}=T_{VJM}; V_D=2/3V_{DRM}$	0.2	V				
I_{GD}		10	mA				
I_H	$T_{VJ}=25^{\circ}C; V_D=6V; R_{GK}=\infty$	100	mA				
R_{thJC}	DC current	1.3	K/W				
R_{thJH}	DC current	1.5	K/W				
a	Max. acceleration, 50 Hz	50	m/s^2				

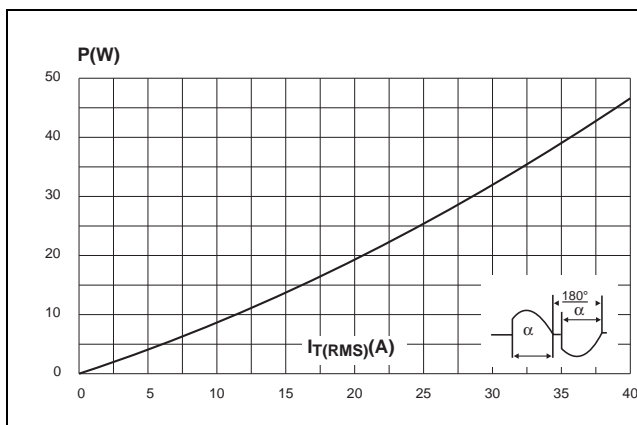

Figure 1. Maximum power dissipation versus on-state rms current (full cycle)

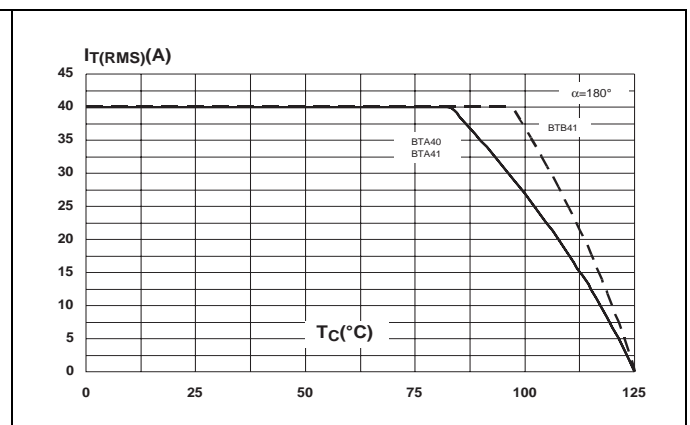

Figure 2. On-state rms current versus case temperature (full cycle)

SBTA41G04B thru SBTA41G16B

Discrete Triacs (Isolated)

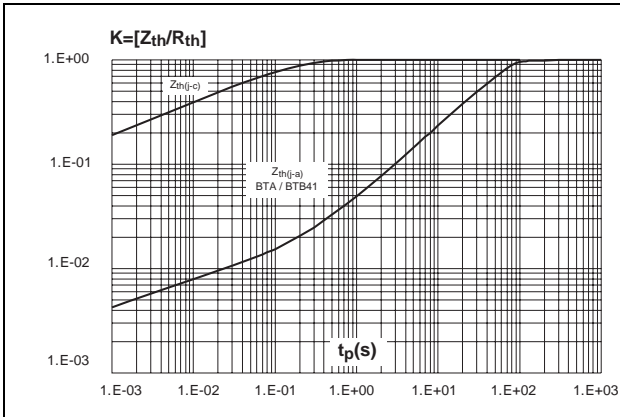

Figure 3. Relative variation of thermal impedance versus pulse duration

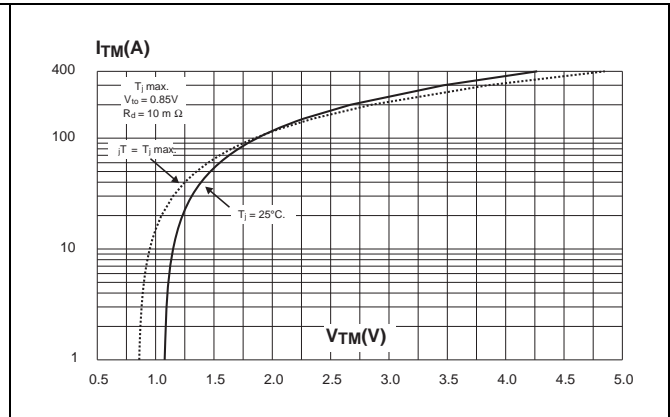

Figure 4. On-state characteristics (maximum values)

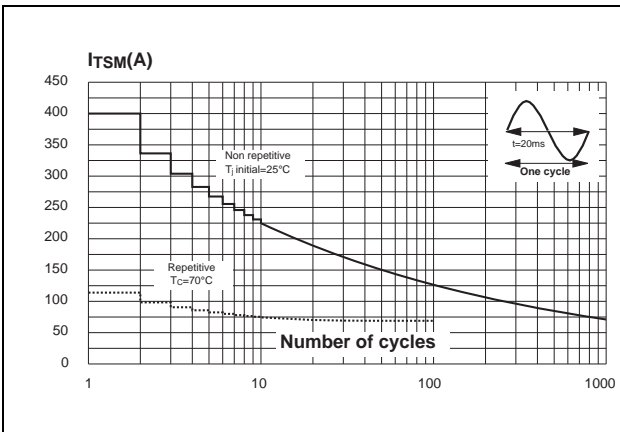

Figure 5. Surge peak on-state current versus number of cycles

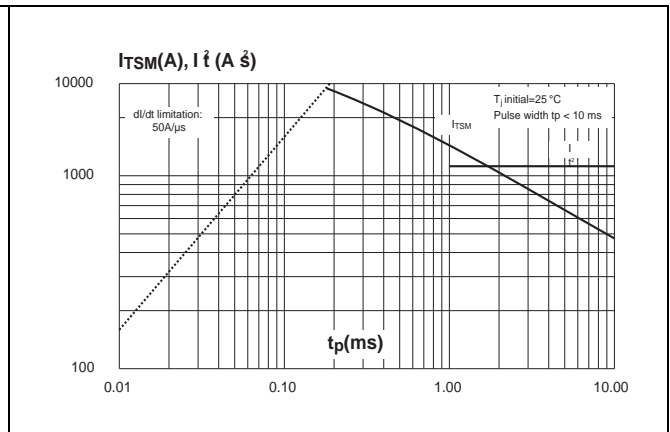

Figure 6. Non-repetitive surge peak on-state current for a sinusoidal pulse and corresponding value of I^2t

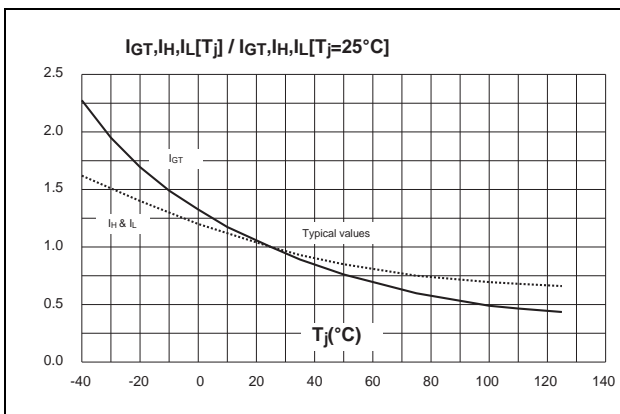

Figure 7. Relative variation of gate trigger, holding and latching current versus junction temperature

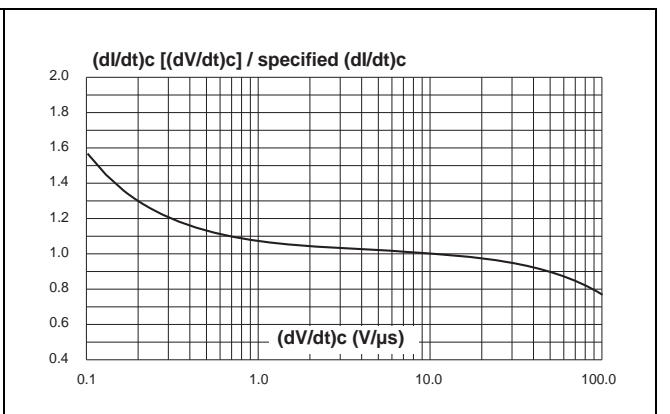

Figure 8. Relative variation of critical rate of decrease of main current versus $(dV/dt)_c$ (typical values)

X-ON Electronics

Largest Supplier of Electrical and Electronic Components

Click to view similar products for [Triacs](#) category:

Click to view products by [Sirectifier](#) manufacturer:

Other Similar products are found below :

[CTA08-1000CW](#) [CTB24-800BW](#) [CTA08-1000C](#) [CTA12-800BWPT](#) [CTA16-1000B](#) [CTB24-800B](#) [BT137-600-0Q](#) [5615](#) [OT415Q](#) [2N6075A](#)
[NTE5629](#) [NTE5688](#) [CTB08-400CW](#) [D31410](#) [BTA416Y-600B.127](#) [T2535T-8I](#) [OT408,135](#) [BT136D](#) [BTB16Q-600BW](#) [Z0409MF](#) [BTA04-600B](#) [BTA06-600BRG](#) [BTA06-800BWRG](#) [BTA08-600BRG](#) [BTA08-800B](#) [BT136-600,127](#) [MAC97A6,116](#) [Z0103NN,135](#) [BT137-600E,127](#)
[BTB16-600CW3G](#) [Z0109MN,135](#) [T825T-6I](#) [T1220T-6I](#) [NTE5638](#) [BT136X-600E,127](#) [MAC4DLM-1G](#) [BT134-600D,127](#) [BTA08-600BW3G](#) [NTE56008](#) [NTE56017](#) [NTE56018](#) [NTE56059](#) [NTE5608](#) [NTE5609](#) [NTE5656](#) [NTE56020](#) [NTE56022](#) [NTE56024](#) [NTE56026](#)
[NTE56028](#)