

SDD/SDA/SDK100NXXB

Diode-Diode Modules

□olerance:±0.5mm

Dimensions in mm (1mm=0.0394")

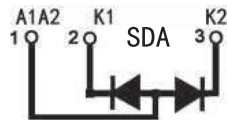
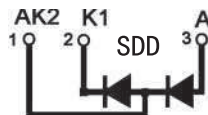

Type	V _{RSM} V	V _{RRM} V
SDD100N08B	900	800
SDD100N12B	1300	1200
SDD100N14B	1500	1400
SDD100N16B	1700	1600
SDD100N18B	1900	1800

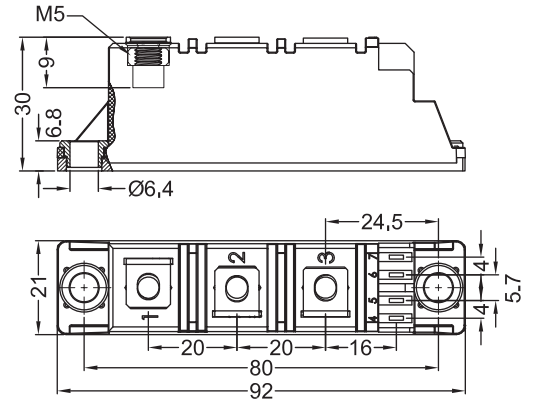
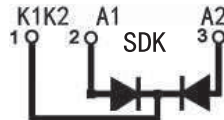

Symbol	Test Conditions	Maximum Ratings	Unit
I _{FRMS} I _{FAVM}	T _{VJ} =T _{VJM} T _C =100°C; 180° sine	180 100	A
I _{FSM}	T _{VJ} =45°C V _R =0 t=10ms (50Hz), sine t=8.3ms (60Hz), sine	1700 1950	A
	T _{VJ} =T _{VJM} V _R =0 t=10ms(50Hz), sine t=8.3ms(60Hz), sine	1540 1800	
∫ _i ² dt	T _{VJ} =45°C V _R =0 t=10ms (50Hz), sine t=8.3ms (60Hz), sine	14450 15700	A ² s
	T _{VJ} =T _{VJM} V _R =0 t=10ms(50Hz), sine t=8.3ms(60Hz), sine	11850 13400	
T _{VJ} T _{VJM} T _{stg}		-40...+150 150 -40...+125	°C
V _{ISOL}	50/60Hz, RMS I _{ISOL} ≤1mA t=1min t=1s	3000 3600	V~
M _d	Mounting torque (M5) Terminal connection torque (M5)	2.5-4/22-35 2.5-4/22-35	Nm/lb.in.
Weight	Typ.	105	g

SDD/SDA/SDK100NXXB

Diode-Diode Modules

Symbol	Test Conditions	Characteristic Values	Unit
I_R	$T_{VJ}=T_{VJM}; V_R=V_{RRM}$	15	mA
V_F	$I_F=300A; T_{VJ}=25^{\circ}C$	1.5	V
V_{TO}	For power-loss calculations only	0.8	V
r_T	$T_{VJ}=T_{VJM}$	2.3	m Ω
Q_S	$T_{VJ}=125^{\circ}C; I_F=50A; -di/dt=3A/us$	170	μC
I_{RM}		45	A
R_{thJC}	per diode; DC current per module	0.35 0.175	K/W
R_{thJK}	per diode; DC current per module	0.55 0.275	K/W
d_s	Creepage distance on surface	12.7	mm
d_A	Strike distance through air	9.6	mm
a	Maximum allowable acceleration	50	m/s ²

FEATURES

- * International standard package
- * Copper base plate
- * Glass passivated chips
- * Isolation voltage 3600 V~
- * UL file NO.310749
- * RoHs compliant

APPLICATIONS

- * Supplies for DC power equipment
- * DC supply for PWM inverter
- * Field supply for DC motors
- * Battery DC power supplies

ADVANTAGES

- * Space and weight savings
- * Simple mounting
- * Improved temperature and power cycling
- * Reduced protection circuits

SDD/SDA/SDK100NXXB

Diode-Diode Modules

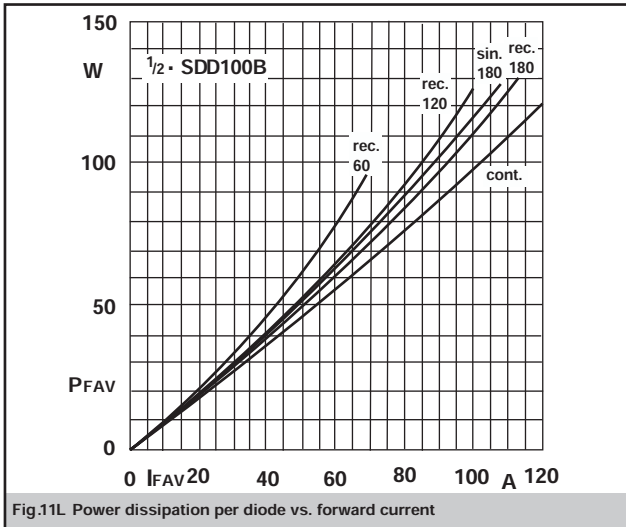

Fig.11L Power dissipation per diode vs. forward current

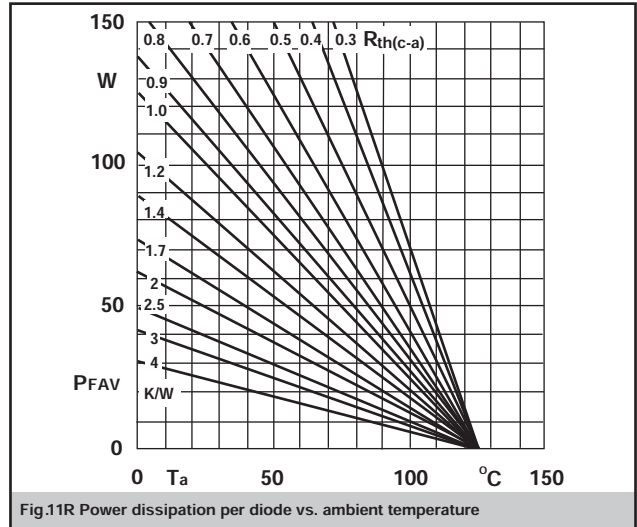

Fig.11R Power dissipation per diode vs. ambient temperature

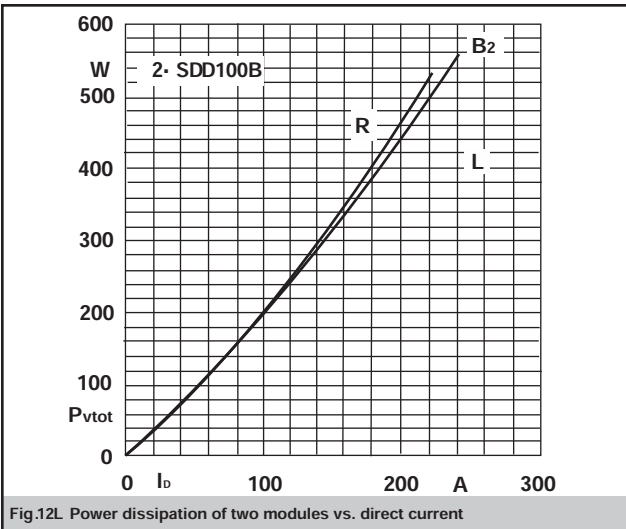

Fig.12L Power dissipation of two modules vs. direct current

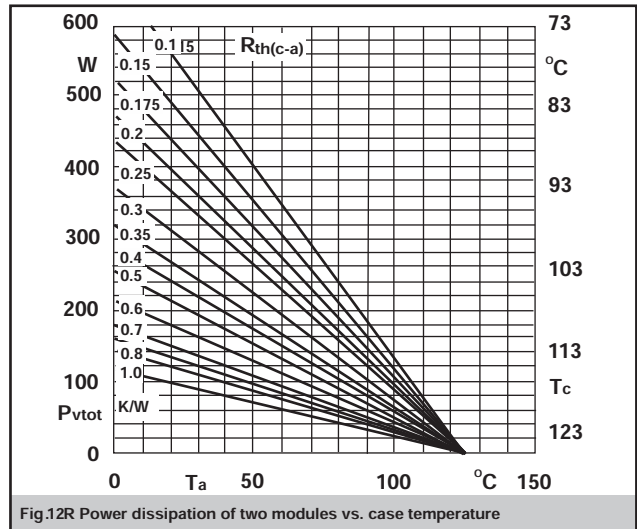

Fig.12R Power dissipation of two modules vs. case temperature

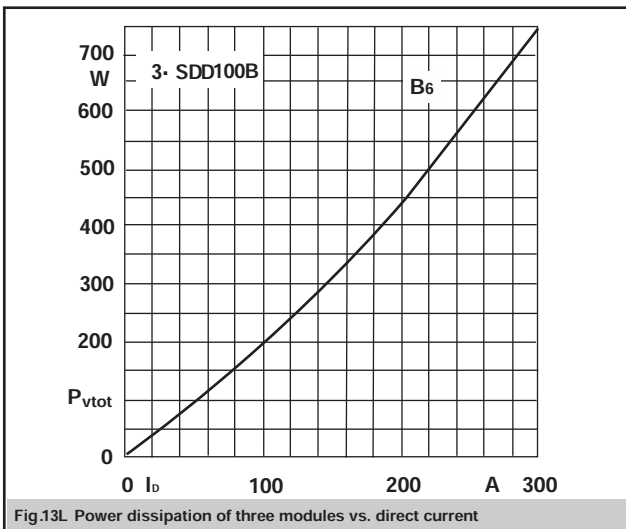

Fig.13L Power dissipation of three modules vs. direct current

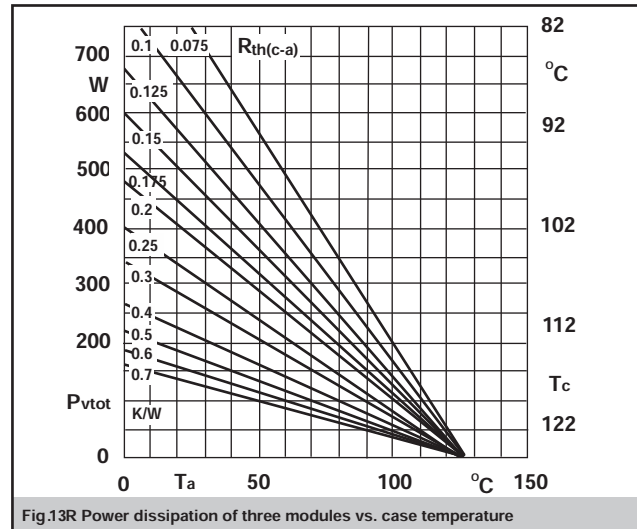

Fig.13R Power dissipation of three modules vs. case temperature

SDD/SDA/SDK100NXXB

Diode-Diode Modules

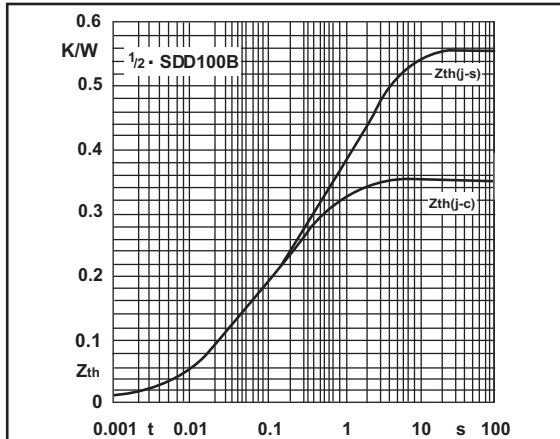

Fig.14 Transient thermal impedance vs. time

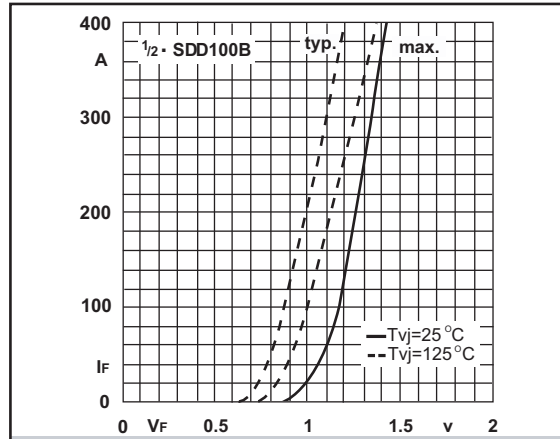

Fig.15 Forward characteristics

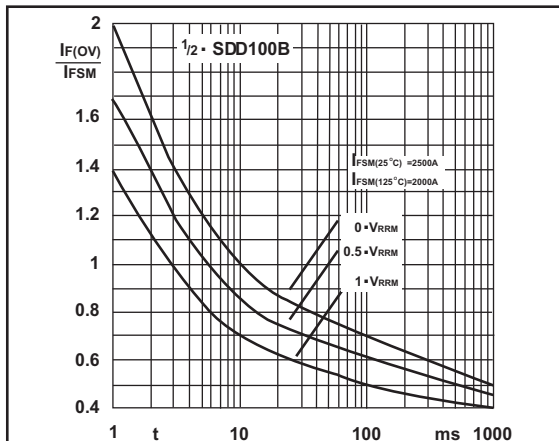

Fig.16 Surge overload current vs. time

X-ON Electronics

Largest Supplier of Electrical and Electronic Components

Click to view similar products for [Discrete Semiconductor Modules](#) category:

Click to view products by [Sirectifier](#) manufacturer:

Other Similar products are found below :

[M252511FV](#) [DD260N12K-A](#) [DD285N02K](#) [DD380N16A](#) [DD89N1600K-A](#) [APT2X21DC60J](#) [APT58M80J](#) [B522F-2-YEC](#) [MSTC90-16](#)
[ND104N16K](#) [25.163.0653.1](#) [25.163.2453.0](#) [25.163.4253.0](#) [25.190.2053.0](#) [25.194.3453.0](#) [25.320.4853.1](#) [25.320.5253.1](#) [25.326.3253.1](#)
[25.326.3553.1](#) [25.330.1653.1](#) [25.330.4753.1](#) [25.330.5253.1](#) [25.334.3253.1](#) [25.334.3353.1](#) [25.350.2053.0](#) [25.352.4753.1](#) [25.522.3253.0](#)
[T483C](#) [T484C](#) [T485F](#) [T485H](#) [T512F-YEB](#) [T513F](#) [T514F](#) [T554](#) [T612FSE](#) [25.161.3453.0](#) [25.179.2253.0](#) [25.194.3253.0](#) [25.325.1253.1](#)
[25.326.4253.1](#) [25.330.0953.1](#) [25.332.4353.1](#) [25.350.1653.0](#) [25.350.2453.0](#) [25.352.1453.0](#) [25.352.1653.0](#) [25.352.2453.0](#) [25.352.5453.1](#)
[25.522.3353.0](#)