

SDD/SDA/SDK100NXXB

Diode-Diode Modules

□olerance:±0.5mm

Dimensions in mm (1mm=0.0394")

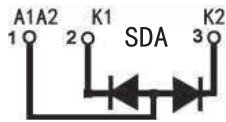
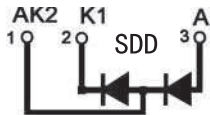

Type	V _{RSM} V	V _{RRM} V
SDD100N08B	900	800
SDD100N12B	1300	1200
SDD100N14B	1500	1400
SDD100N16B	1700	1600
SDD100N18B	1900	1800

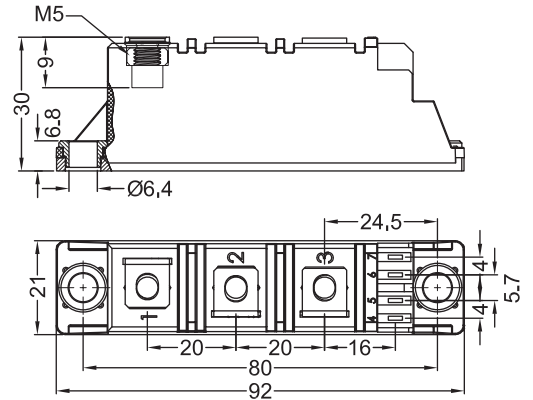
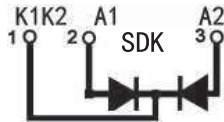

Symbol	Test Conditions	Maximum Ratings	Unit
I _{FRMS} I _{FAVM}	T _{VJ} =T _{VJM} T _C =100°C; 180° sine	180 100	A
I _{FSM}	T _{VJ} =45°C V _R =0 t=10ms (50Hz), sine t=8.3ms (60Hz), sine	1700 1950	A
	T _{VJ} =T _{VJM} V _R =0 t=10ms(50Hz), sine t=8.3ms(60Hz), sine	1540 1800	
∫ _i ² dt	T _{VJ} =45°C V _R =0 t=10ms (50Hz), sine t=8.3ms (60Hz), sine	14450 15700	A ² s
	T _{VJ} =T _{VJM} V _R =0 t=10ms(50Hz), sine t=8.3ms(60Hz), sine	11850 13400	
T _{VJ} T _{VJM} T _{stg}		-40...+150 150 -40...+125	°C
V _{ISOL}	50/60Hz, RMS I _{ISOL} ≤1mA t=1min t=1s	3000 3600	V~
M _d	Mounting torque (M5) Terminal connection torque (M5)	2.5-4/22-35 2.5-4/22-35	Nm/lb.in.
Weight	Typ.	105	g

SDD/SDA/SDK100NXXB

Diode-Diode Modules

Symbol	Test Conditions	Characteristic Values	Unit
I_R	$T_{VJ}=T_{VJM}; V_R=V_{RRM}$	15	mA
V_F	$I_F=300A; T_{VJ}=25^{\circ}C$	1.5	V
V_{TO}	For power-loss calculations only	0.8	V
r_T	$T_{VJ}=T_{VJM}$	2.3	m Ω
Q_S	$T_{VJ}=125^{\circ}C; I_F=50A; -di/dt=3A/us$	170	μC
I_{RM}		45	A
R_{thJC}	per diode; DC current per module	0.35 0.175	K/W
R_{thJK}	per diode; DC current per module	0.55 0.275	K/W
d_s	Creepage distance on surface	12.7	mm
d_A	Strike distance through air	9.6	mm
a	Maximum allowable acceleration	50	m/s ²

FEATURES

- * International standard package
- * Copper base plate
- * Glass passivated chips
- * Isolation voltage 3600 V~
- * UL file NO.310749
- * RoHs compliant

APPLICATIONS

- * Supplies for DC power equipment
- * DC supply for PWM inverter
- * Field supply for DC motors
- * Battery DC power supplies

ADVANTAGES

- * Space and weight savings
- * Simple mounting
- * Improved temperature and power cycling
- * Reduced protection circuits

SDD/SDA/SDK100NXXB

Diode-Diode Modules

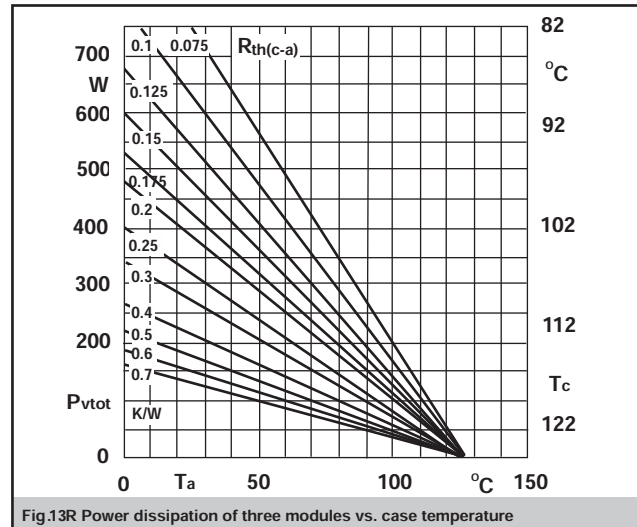
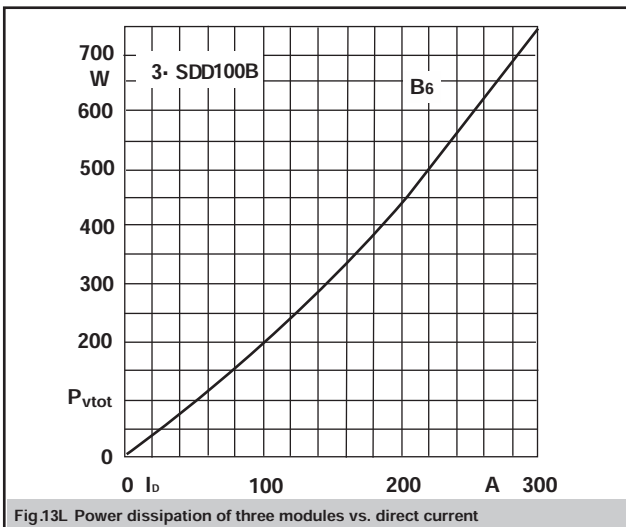
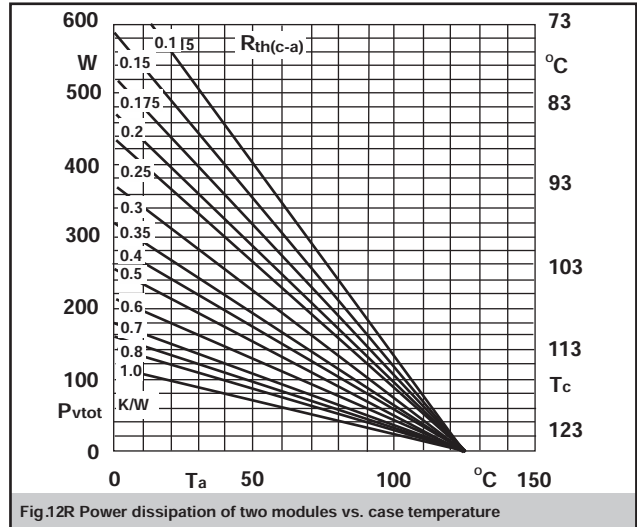
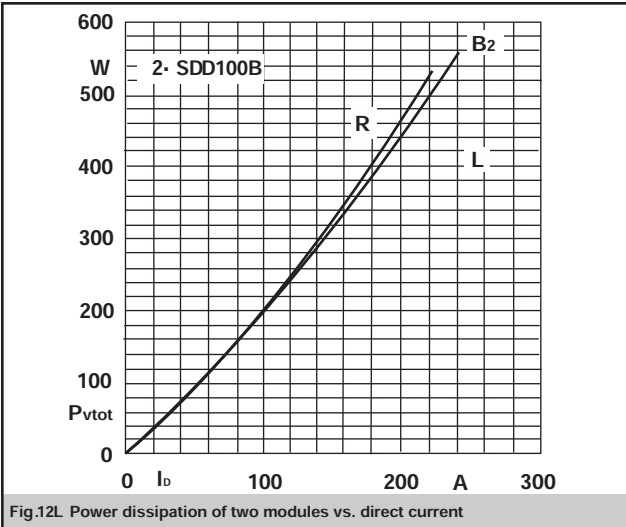
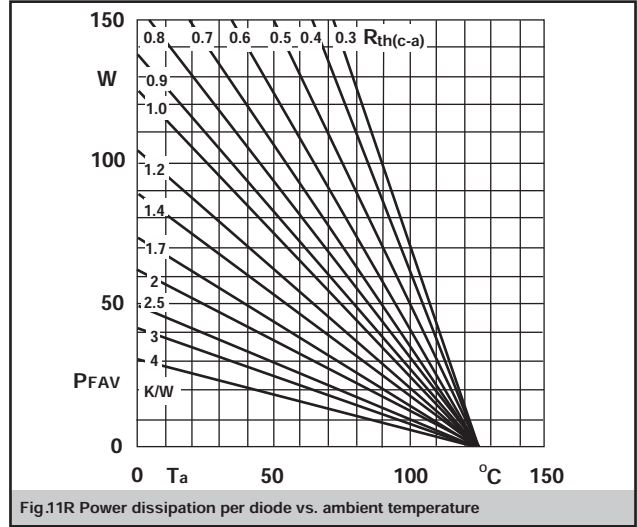
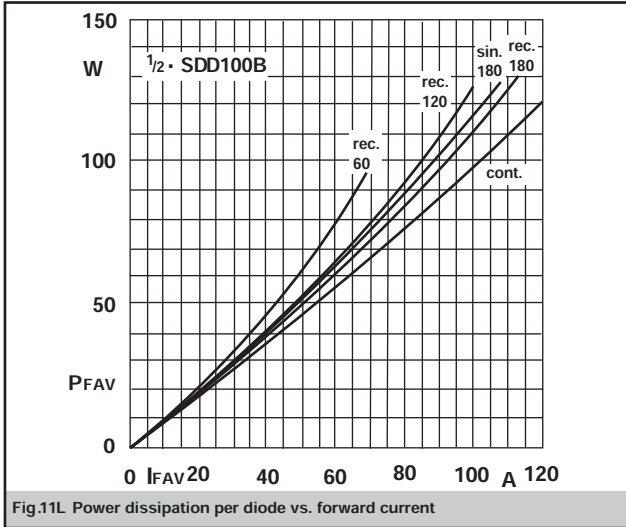

SDD/SDA/SDK100NXXB

Diode-Diode Modules

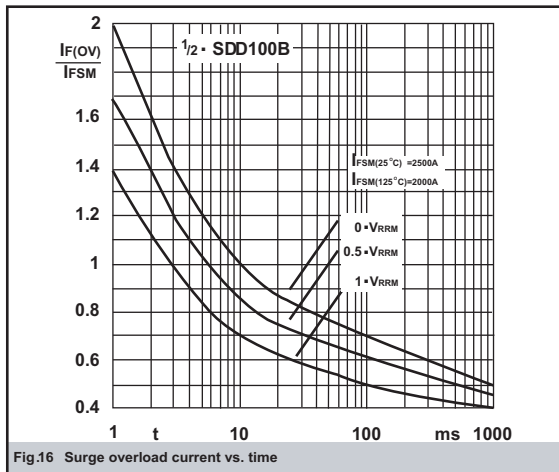
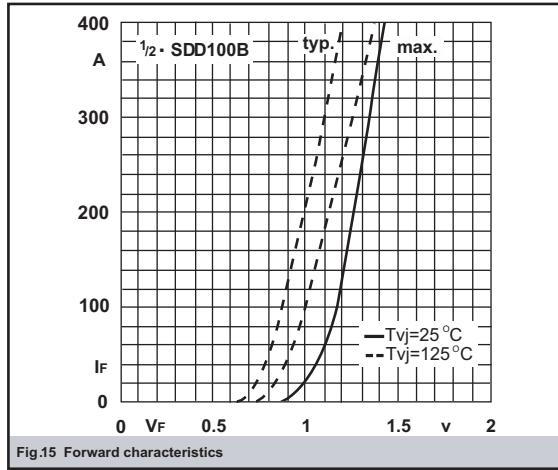
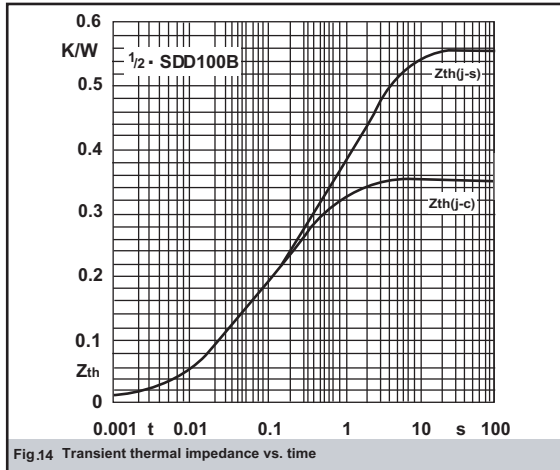

X-ON Electronics

Largest Supplier of Electrical and Electronic Components

Click to view similar products for [Discrete Semiconductor Modules](#) category:

Click to view products by [Sirectifier](#) manufacturer:

Other Similar products are found below :

[M252511FV](#) [DD260N12K-A](#) [DD285N02K](#) [DD380N16A](#) [DD89N1600K-A](#) [APT2X21DC60J](#) [APT58M80J](#) [B522F-2-YEC](#) [MSTC90-16](#)
[ND104N16K](#) [25.163.0653.1](#) [25.163.2453.0](#) [25.163.4253.0](#) [25.190.2053.0](#) [25.194.3453.0](#) [25.320.4853.1](#) [25.320.5253.1](#) [25.326.3253.1](#)
[25.326.3553.1](#) [25.330.1653.1](#) [25.330.4753.1](#) [25.330.5253.1](#) [25.334.3253.1](#) [25.334.3353.1](#) [25.350.2053.0](#) [25.352.4753.1](#) [25.522.3253.0](#)
[T483C](#) [T484C](#) [T485F](#) [T485H](#) [T512F-YEB](#) [T513F](#) [T514F](#) [T554](#) [T612FSE](#) [25.161.3453.0](#) [25.179.2253.0](#) [25.194.3253.0](#) [25.325.1253.1](#)
[25.326.4253.1](#) [25.330.0953.1](#) [25.332.4353.1](#) [25.350.1653.0](#) [25.350.2453.0](#) [25.352.1453.0](#) [25.352.1653.0](#) [25.352.2453.0](#) [25.352.5453.1](#)
[25.522.3353.0](#)