

# STT165GKLLB

## Thyristor-Thyristor Modules

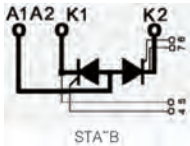
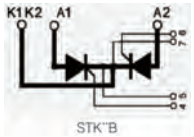
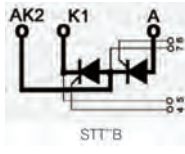

Type	$V_{RSM}$ $V_{DSM}$ V	$V_{RRM}$ $V_{DRM}$ V
STT165GK08B	900	800
STT165GK12B	1300	1200
STT165GK14B	1500	1400
STT165GK16B	1700	1600
STT165GK18B	1900	1800
STT165GK20B	2100	2000
STT165GK22B	2300	2200

Dimensions in mm (1mm=0.0394")

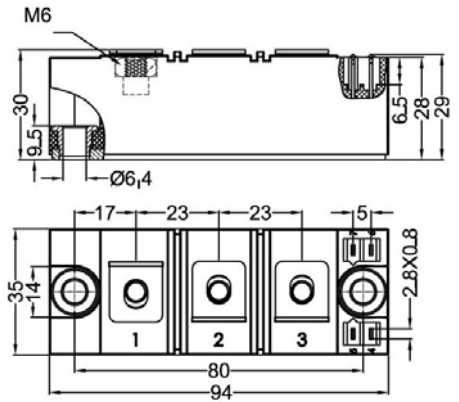

Symbol	Test Conditions	Maximum Ratings	Unit
$I_{TRMS}$ , $I_{FRMS}$ $I_{TAVM}$ , $I_{FAVM}$	$T_V = T_{VJM}$ $T_C = 85^\circ\text{C}$ ; 180° sine	300 165	A
$I_{TSM}$ , $I_{FSM}$	$T_V = 45^\circ\text{C}$ $V_R = 0$ $t = 10\text{ms}$ (50Hz), sine $t = 8.3\text{ms}$ (60Hz), sine	6000 6400	A
	$T_V = T_{VJM}$ $V_R = 0$ $t = 10\text{ms}$ (50Hz), sine $t = 8.3\text{ms}$ (60Hz), sine	5250 5600	
$\int i^2 dt$	$T_V = 45^\circ\text{C}$ $V_R = 0$ $t = 10\text{ms}$ (50Hz), sine $t = 8.3\text{ms}$ (60Hz), sine	180000 170000	$\text{A}^2\text{s}$
	$T_V = T_{VJM}$ $V_R = 0$ $t = 10\text{ms}$ (50Hz), sine $t = 8.3\text{ms}$ (60Hz), sine	137000 128000	
$(di/dt)_{cr}$	$T_V = T_{VJM}$ $f = 50\text{Hz}$ , $t_p = 200\mu\text{s}$ $V_D = 2/3 V_{DRM}$ $I_G = 0.5\text{A}$ $di/dt = 0.5\text{A}/\mu\text{s}$ repetitive, $I_T = 500\text{A}$	150	A/us
	non repetitive, $I_T = I_{TAVM}$	500	
$(dv/dt)_{cr}$	$T_V = T_{VJM}$ ; $R_{GK} = \infty$ ; method 1 (linear voltage rise) $V_{DR} = 2/3 V_{DRM}$	1000	V/us
$P_{GM}$	$T_V = T_{VJM}$ $I_T = I_{TAVM}$ $t_p = 30\mu\text{s}$ $t_p = 500\mu\text{s}$	120	W
		60	
$P_{GAV}$		8	W
$V_{RGM}$		10	V
$T_V$ $T_{VJM}$ $T_{stg}$		-40...+125	$^\circ\text{C}$
		125	
		-40...+125	
$V_{ISOL}$	50/60Hz, RMS $I_{ISOL} \leq 1\text{mA}$ $t = 1\text{min}$ $t = 1\text{s}$	3000	V~
		3600	
$M_d$	Mounting torque (M6) Terminal connection torque (M6)	2.25-2.75/20-25	Nm/lb.in.
		4.5-5.5/40-48	
Weight	Typical	173	g



# STT165GKLLB

## Thyristor-Thyristor Modules

Symbol	Test Conditions	Characteristic Values	Unit
$I_{RRM}, I_{DRM}$	$T_{VJ}=T_{VJM}; V_R=V_{RRM}; V_D=V_{DRM}$	40	mA
$V_T, V_F$	$I_T, I_F=300A; T_{VJ}=25^{\circ}C$	1.36	V
$V_{TO}$	For power-loss calculations only ( $T_{VJ}=T_{VJM}$ )	0.8	V
$r_T$		1.6	$m\Omega$
$V_{GT}$	$V_D=6V;$ $T_{VJ}=25^{\circ}C$ $T_{VJ}=-40^{\circ}C$	2 2.6	V
$I_{GT}$	$V_D=6V;$ $T_{VJ}=25^{\circ}C$ $T_{VJ}=-40^{\circ}C$	150 200	mA
$V_{GD}$	$T_{VJ}=T_{VJM};$ $V_D=2/3V_{DRM}$	0.25	V
$I_{GD}$	$T_{VJ}=T_{VJM};$ $V_D=2/3V_{DRM}$	10	mA
$I_L$	$T_{VJ}=25^{\circ}C; t_p=30\mu s; V_D=6V$ $I_G=0.45A; di_G/dt=0.45A/\mu s$	200	mA
$I_H$	$T_{VJ}=25^{\circ}C; V_D=6V; R_{GK}=\infty$	150	mA
$t_{gd}$	$T_{VJ}=25^{\circ}C; V_D=1/2V_{DRM}$ $I_G=0.5A; di_G/dt=0.5A/\mu s$	2	$\mu s$
$t_q$	$T_{VJ}=T_{VJM}; I_T=160A; t_p=200\mu s; -di/dt=10A/\mu s$ $V_R=100V; dv/dt=20V/\mu s; V_D=2/3V_{DRM}$	150	$\mu s$
$Q_s$	$T_{VJ}=T_{VJM}; I_T, I_F=300A; -di/dt=50A/\mu s$	550	$\mu C$
$I_{RM}$		235	A
$R_{thJC}$	per thyristor/diode; DC current per module	0.155 0.0775	K/W
$R_{thJK}$	per thyristor/diode; DC current per module	0.225 0.1125	K/W
$d_s$	Creeping distance on surface	12.7	mm
$d_A$	Creepage distance in air	9.6	mm
$a$	Maximum allowable acceleration	50	$m/s^2$

### FEATURES

- \* International standard package
- \* Copper base plate
- \* Glass passivated chips
- \* Isolation voltage 3600 V~
- \* UL file NO.E310749
- \* RoHS compliant

### APPLICATIONS

- \* Motor control
- \* Power converter
- \* Heat and temperature control for industrial furnaces and chemical processes
- \* Lighting control
- \* Contactless switches

### ADVANTAGES

- \* Space and weight savings
- \* Simple mounting
- \* Improved temperature and power cycling
- \* Reduced protection circuits

**Sirectifier**<sup>®</sup>

# STT165GKLLB

## Thyristor-Thyristor Modules

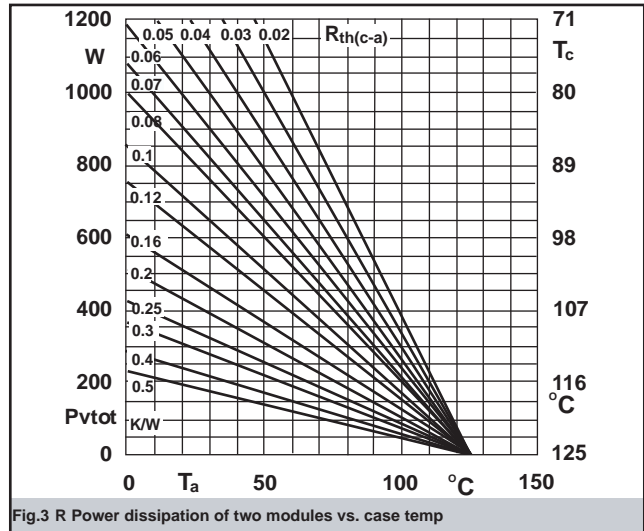
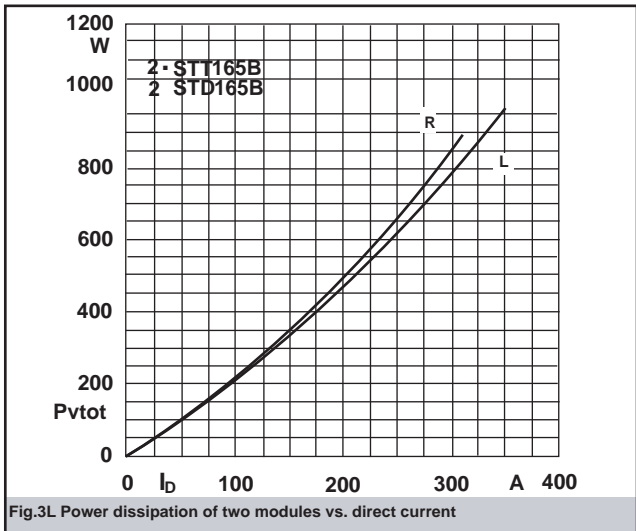
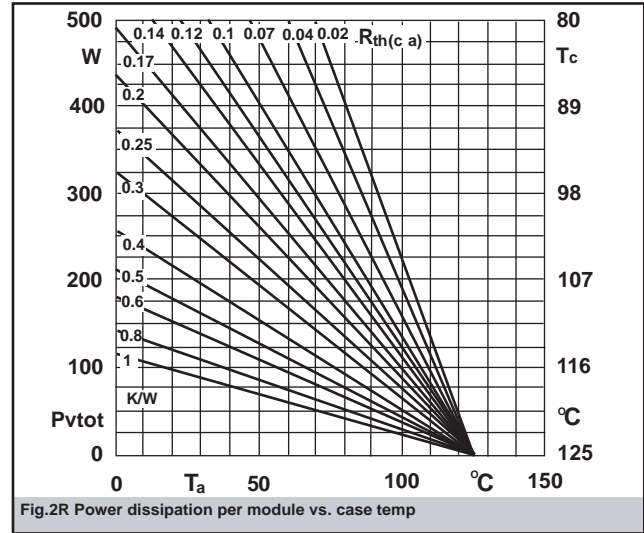
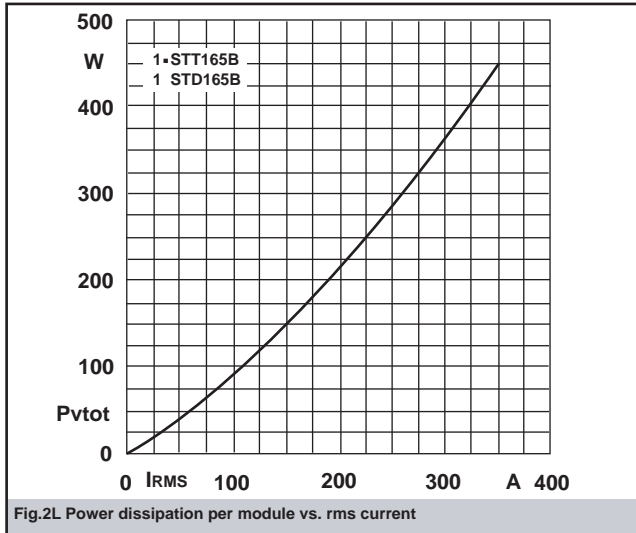
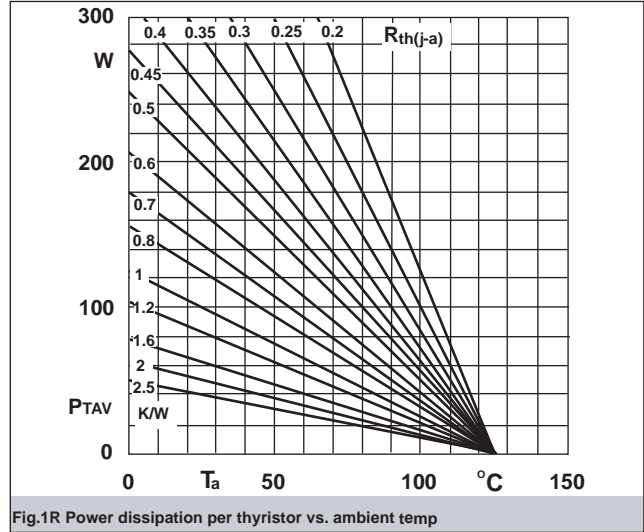
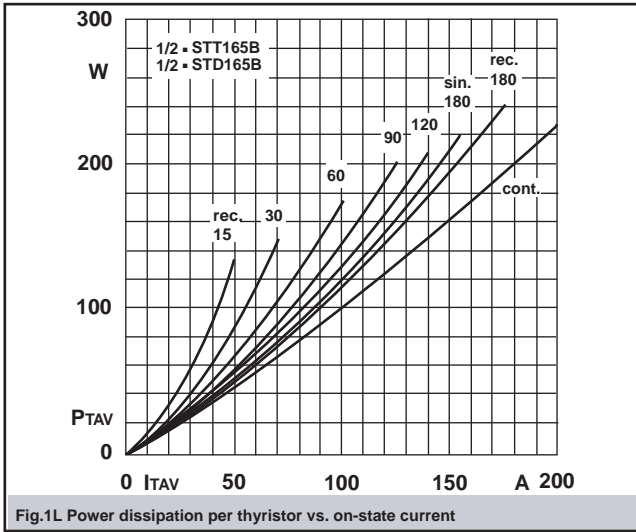

# STT165GKLLB

## Thyristor-Thyristor Modules

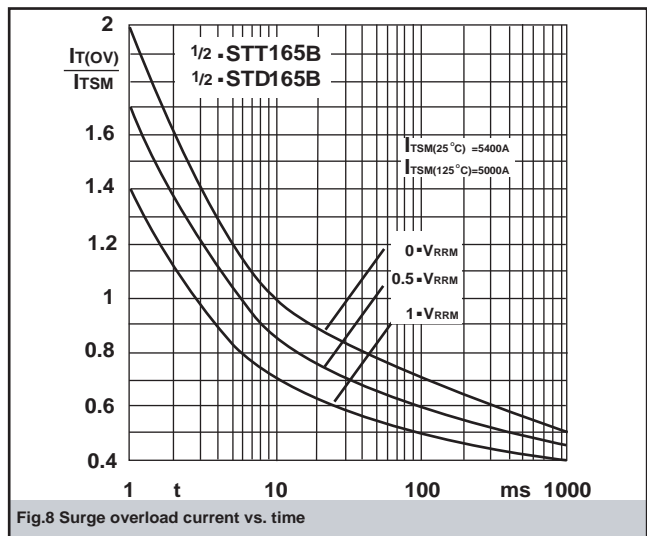
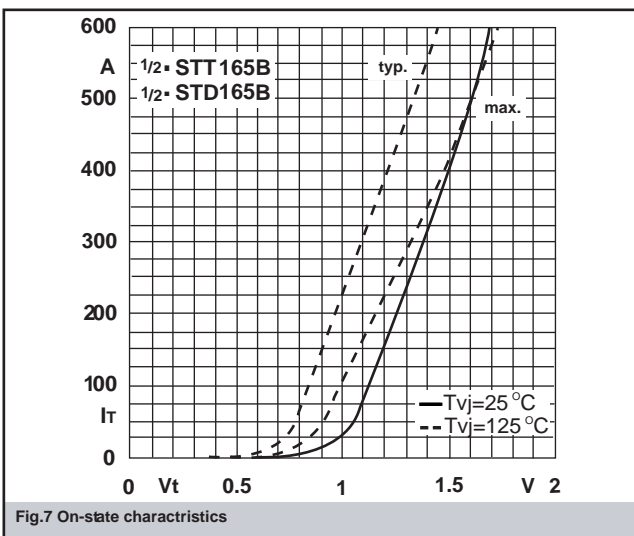
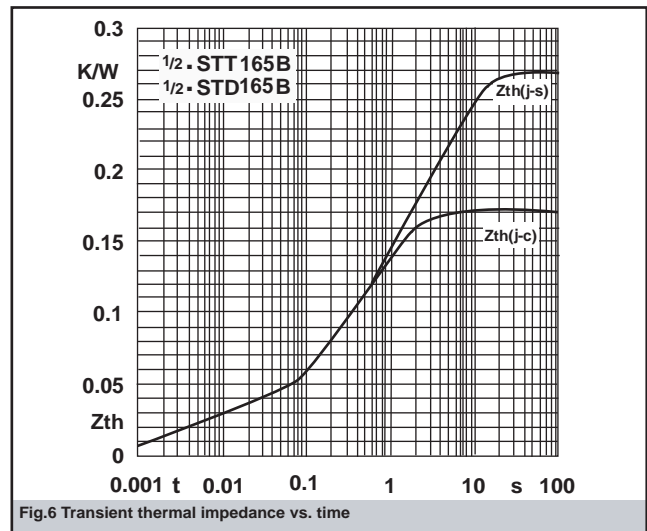
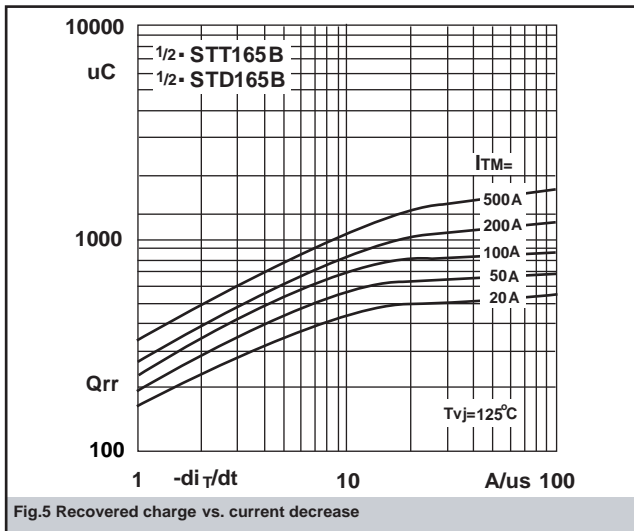
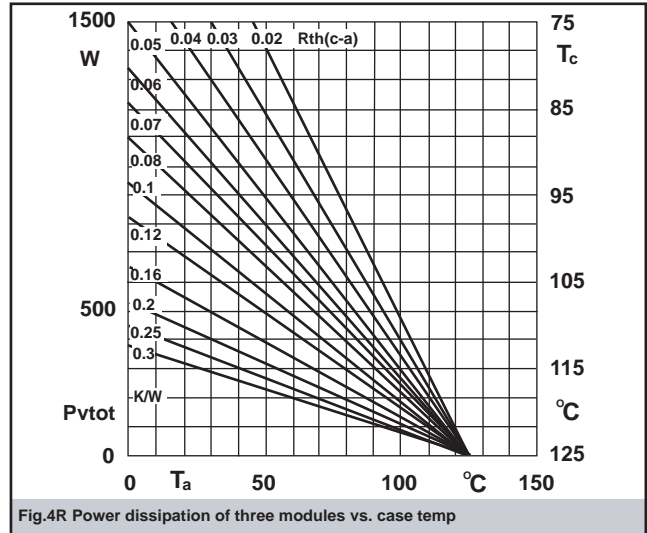
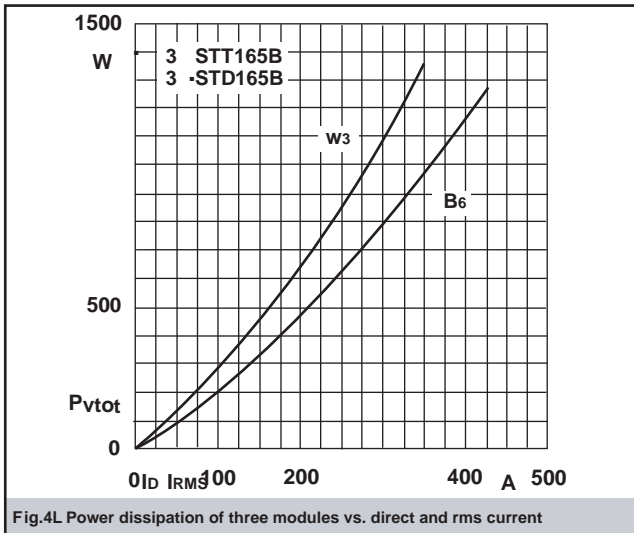

## X-ON Electronics

Largest Supplier of Electrical and Electronic Components

*Click to view similar products for [Discrete Semiconductor Modules](#) category:*

*Click to view products by [Sirectifier](#) manufacturer:*

Other Similar products are found below :

[M252511FV](#) [DD260N12K-A](#) [DD285N02K](#) [DD380N16A](#) [DD89N1600K-A](#) [APT2X21DC60J](#) [APT58M80J](#) [B522F-2-YEC](#) [MSTC90-16](#)  
[ND104N16K](#) [25.163.0653.1](#) [25.163.2453.0](#) [25.163.4253.0](#) [25.190.2053.0](#) [25.194.3453.0](#) [25.320.4853.1](#) [25.320.5253.1](#) [25.326.3253.1](#)  
[25.326.3553.1](#) [25.330.1653.1](#) [25.330.4753.1](#) [25.330.5253.1](#) [25.334.3253.1](#) [25.334.3353.1](#) [25.350.2053.0](#) [25.352.4753.1](#) [25.522.3253.0](#)  
[T483C](#) [T484C](#) [T485F](#) [T485H](#) [T512F-YEB](#) [T513F](#) [T514F](#) [T554](#) [T612FSE](#) [25.161.3453.0](#) [25.179.2253.0](#) [25.194.3253.0](#) [25.325.1253.1](#)  
[25.326.4253.1](#) [25.330.0953.1](#) [25.332.4353.1](#) [25.350.1653.0](#) [25.350.2453.0](#) [25.352.1453.0](#) [25.352.1653.0](#) [25.352.2453.0](#) [25.352.5453.1](#)  
[25.522.3353.0](#)