



MIKE 3A

GPS IP67 Magnetic Mount Antenna



Key Features

- 28dB LNA gain
- Weather Resistant
- Dual mount
- Ground plane independent

General Description

The MIKE 3A is a compact dual mount GPS antenna, tuned to 1575.42MHz Band L1.

Dual mounting: with its magnetic base and separate adhesive pad, the Mike 3A can be mounted onto a diverse range of surfaces.

The weather resistant design makes it an ideal outdoor GPS antenna that can be used for a host of different GPS applications including: vehicle/fleet/asset tracking and mobile applications.

The built in Low Noise Amplifier (LNA) provides a 28dB gain producing stronger signals which reduce satellite fix times.

Additional Considerations

- Improves signal to noise ratio for mobile applications
- Mixed mounting - magnetic or adhesive pad
- Meets all EU compliance criteria for electronic goods





Mike 3A

GPS IP67 Magnetic Mount Antenna

Dielectric Antenna

VSWR:	1.5:1
Impedance:	50 Ohms
Centre Frequency:	1575.42 MHz
Peak Gain:	>3dBic (Based on 7 x 7cm Ground plane)
Gain Coverage:	>4dBic at 90°
Polarization:	RHCP

GPS Antenna

LNA Gain:	28 dB Typical
Noise Figure:	1.5 dB
Connector:	SMA Male
VSWR:	<2.0
DC Voltage:	3.0 V - 5.0 V
DC Current:	10 mA Max

Mechanical Specifications

Dimensions:	L50 x W39 x H17 mm
Cable:	RG174
Connector:	SMA Male
Mounting Method:	Magnetic

Environmental Specifications

Operating Temperature:	-40 - +85 °C
Storage Temperature:	-45 - +100 °C
Humidity:	95% - 100% RH

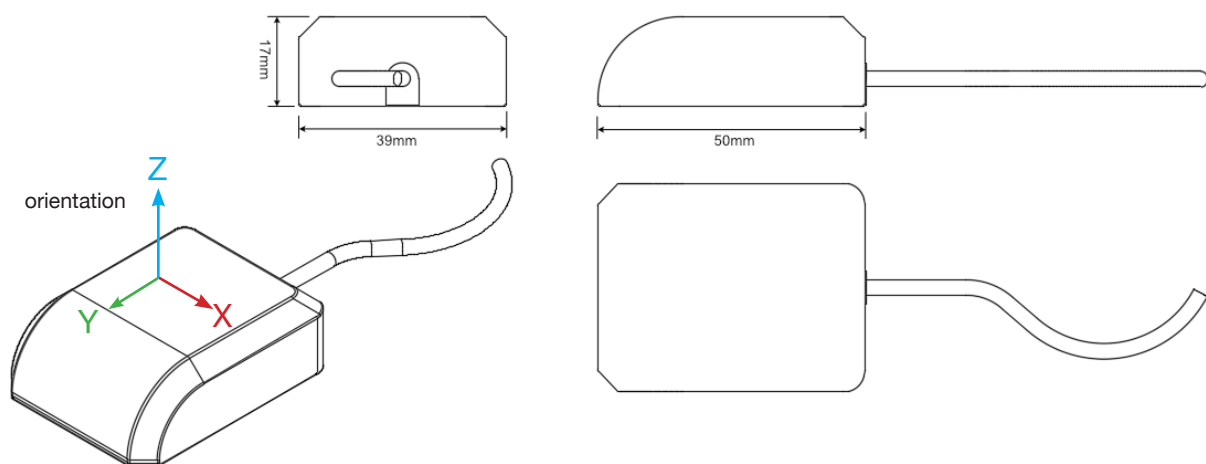



Mike 3A

GPS IP67 Magnetic Mount Antenna

Radiation Patterns measured with 5m cable

1560MHz

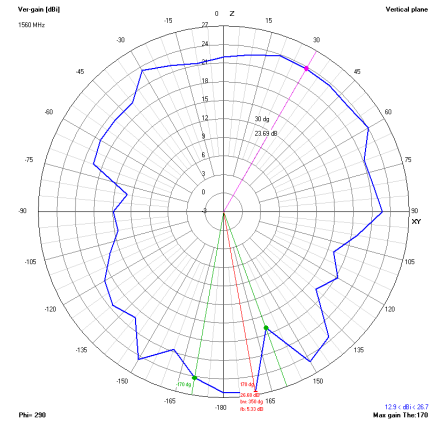
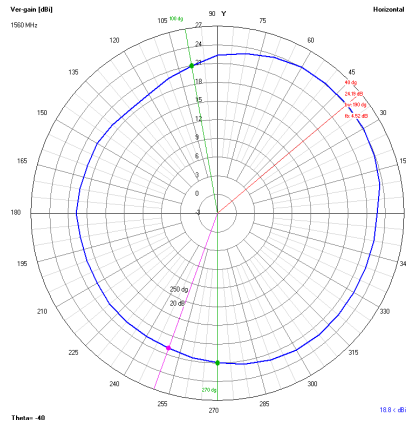
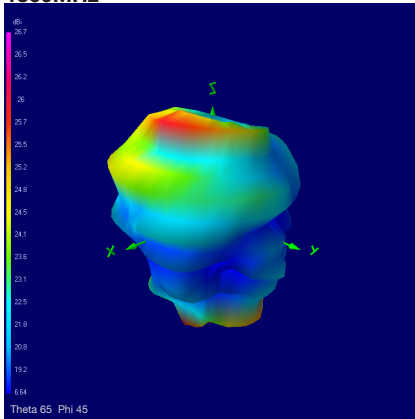

1580MHz

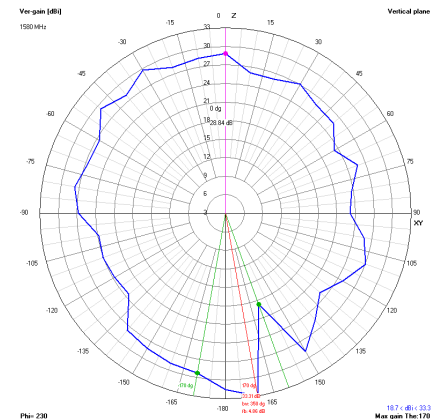
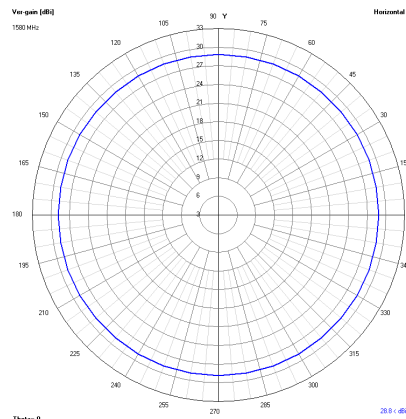
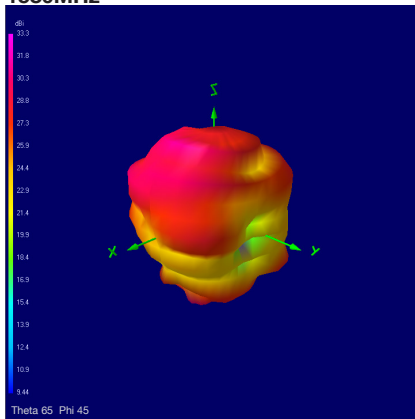

Ordering Details

Part Number	Description
MIKE3A/0.5M/SMAM/RA/S/17	GPS, IP67 MAGNETIC MOUNT ANTENNA SMA MALE RIGHT ANGLE CONNECTOR 0.5m CABLE
MIKE3A/2.5M/SMAM/S/S/17	GPS, IP67 MAGNETIC MOUNT ANTENNA SMA MALE CONNECTOR 2.5m CABLE
MIKE3A/3M/SMAM/S/S/17	GPS, IP67 MAGNETIC MOUNT ANTENNA SMA MALE CONNECTOR 3m CABLE
MIKE3A/5M/SMAM/S/S/17	GPS, IP67 MAGNETIC MOUNT ANTENNA SMA MALE CONNECTOR 5m CABLE
MIKE3A/5M/SMAM/S/RA/17	GPS, IP67 MAGNETIC MOUNT ANTENNA SMA MALE RIGHT ANGLE CONNECTOR 5m CABLE

X-ON Electronics

Largest Supplier of Electrical and Electronic Components

Click to view similar products for [Antennas](#) category:

Click to view products by [SIRETTA](#) manufacturer:

Other Similar products are found below :

[930-033-R](#) [EXE902SM](#) [APAMPG-117](#) [MAF94383](#) [108-00014-50](#) [SPDA17RP918](#) [A09-F5NF-M](#) [RGFRA1903041A1T](#) [108-00016-050](#)
[W3921B0100](#) [SIMNA-868](#) [SIMNA-915](#) [SIMNA-433](#) [W1049B090](#) [TRABT1560](#) [W3118A](#) [WTL2449CQ1-FRSMM](#) [CPL9C](#) [0600-00060](#)
[GD5W-28P-NF](#) [PAL90209H-FNF](#) [MA9-7N](#) [GD53-25](#) [C37](#) [MAF94051](#) [S9025PLSMF](#) [EXD420PL](#) [B1322NR](#) [MAF94300](#) [GPSMB301](#)
[FG4403](#) [MIKROE-2393](#) [DA5-32RADOME](#) [BB1442NR](#) [5200227](#) [GPSCPMM00](#) [ANTDOM-05-01-WPM](#) [ANT-WP868SMA-Y](#)
[EXW30BNX](#) [OSCAR1A/5M/SMAM/S/S/31](#) [ALPHA4A/1M/SMAM/S/S/26](#) [OSCAR1A/10M/SMAM/S/S/31](#) [OSCAR1A/20M/SMAM/S/S/31](#)
[OSCAR40/5M/LL/SMAM/S/S/33](#) [TANGO41/1M/SMAM/S/S/32](#) [ANTX100ETBAB24553](#) [S4908WBFNM](#) [FXR.01.07.0100C.A](#) [GD57-21](#)
[001-0016](#)