



Tango 28

2.4 GHz Tiny Stubby Panel Mount Wi-Fi/Bluetooth/Zigbee Antenna



Key Features

- Supports Dual Band Wi-Fi 2.4 GHz & 5 GHz spectrum
- Supports some of 5G NR / 4G LTE bands
- Supports ISM 2450 / ISM 5800 / WLAN 2400 / WLAN 5800 bands
- Supports Bluetooth / Zigbee / IEEE 802.15.4
- Panel mount, small stubby antenna
- Tiny 12.3mm height from panel surface to antenna top
- 5mm thread segment

General Description

The Tango 28 is a very small panel mount antenna. Ideal for small projects located within a good signal zone.

The antenna is compatible with Bluetooth, Wi-Fi (both 2.4 GHz & 5 GHz) and Zigbee enabled IoT devices.

Supplied as standard with 100mm of 1.13mm Ø cable and an I-PEX / uFL connector. Alternative connectors and cable lengths may be specified for volume orders.

Additional Considerations

- Allows simple connection onto PCB
- Ground Plane Independent

T Through	5G New Radio	4G LTE	ISM 2450	ISM 5800
IEEE 802.15.4	BLE Bluetooth	WiFi 2.4G & 5G	ZB Zigbee	WLAN 2400
WLAN 5800	WiFi 4 802.11n	WiFi 5 802.11ac	WiFi 6 802.11ax	



Tango 28

2.4 GHz Tiny Stubby Panel Mount Wi-Fi/Bluetooth/Zigbee Antenna

Electrical Specifications

Impedance:	50 Ohm
Polarization:	Omni-directional
Max Input Power:	1 W
Ground plane independent:	No

Environmental Specifications

Operating Temperature range:	-25 to +65 °C
Storage Temperature range:	-25 to +65 °C

Mechanical Specifications

Dimensions:	H18.3 x 8.5 mm diameter
Weight:	2.60 g
Cable:	RG178
Connector:	I-PEX / uFL
Mounting method:	Panel mount
Housing materials:	TPR

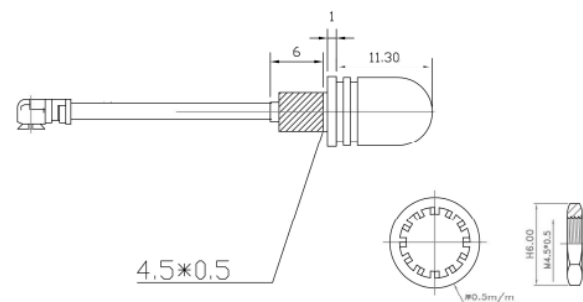
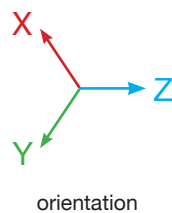



Tango 28

2.4 GHz Tiny Stubby Panel Mount Wi-Fi/Bluetooth/Zigbee Antenna

Spectrum Coverage

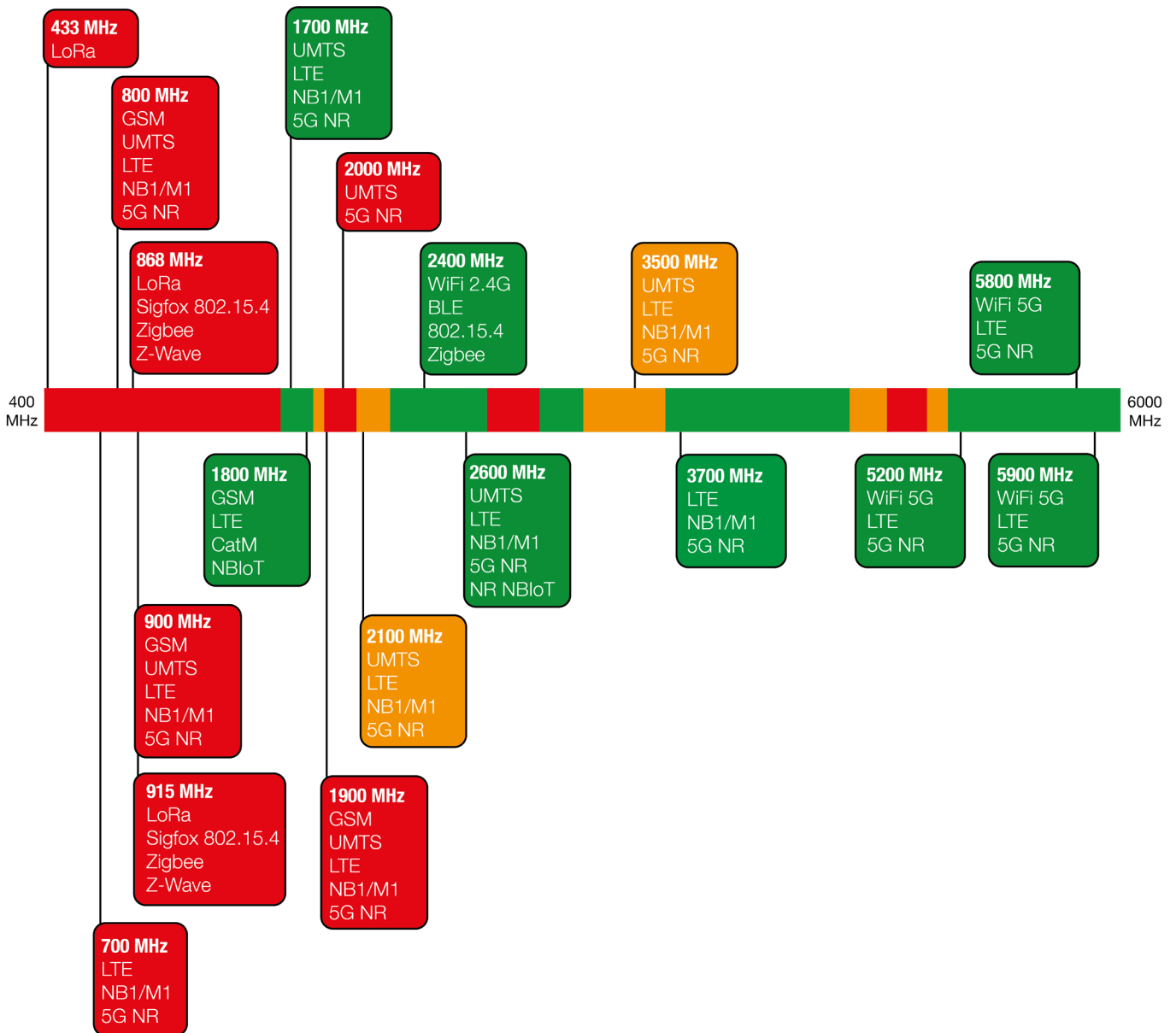

● Suitable band

● Adequate band in good signal conditions

● Likely to be unsuitable



Tango 28

2.4 GHz Tiny Stubby Panel Mount Wi-Fi/Bluetooth/Zigbee Antenna

Usable Cellular Frequency Support (410 MHz – 1900 MHz)

	410	450	600	700	800	850	900	1500	1600	1700	1800	1900
GSM Bands:											●	
UMTS Bands:										●	●	
LTE Bands:										●	●	
LTE Cat M Bands:										●	●	
LTE Cat NB Bands:										●	●	
5G NR Bands:										●	●	
NR Cat NB Bands:										●	●	

Usable Cellular Frequency Support (2000 MHz – 5900 MHz)

	2000	2100	2300	2400	2500	2600	3300	3500	3700	4700	5200	5900
GSM Bands:												
UMTS Bands:						●						
LTE Bands:			●	●		●		●	●		●	●
LTE Cat M Bands:			●			●		●				
LTE Cat NB Bands:						●		●				
5G NR Bands:			●	●		●		●			●	●
NR Cat NB Bands:						●						

Usable ISM Frequency Support (433 MHz - 5800 MHz)

	433	868	915	2450	5800
Bluetooth				●	
IEEE 802.15.4				●	
LoRa					
Sigfox					
WiFi 2.4G				●	
WiFi 5G					●
Zigbee				●	
Z-Wave					



Tango 28

2.4 GHz Tiny Stubby Panel Mount Wi-Fi/Bluetooth/Zigbee Antenna

Peak Gain vs. Frequency

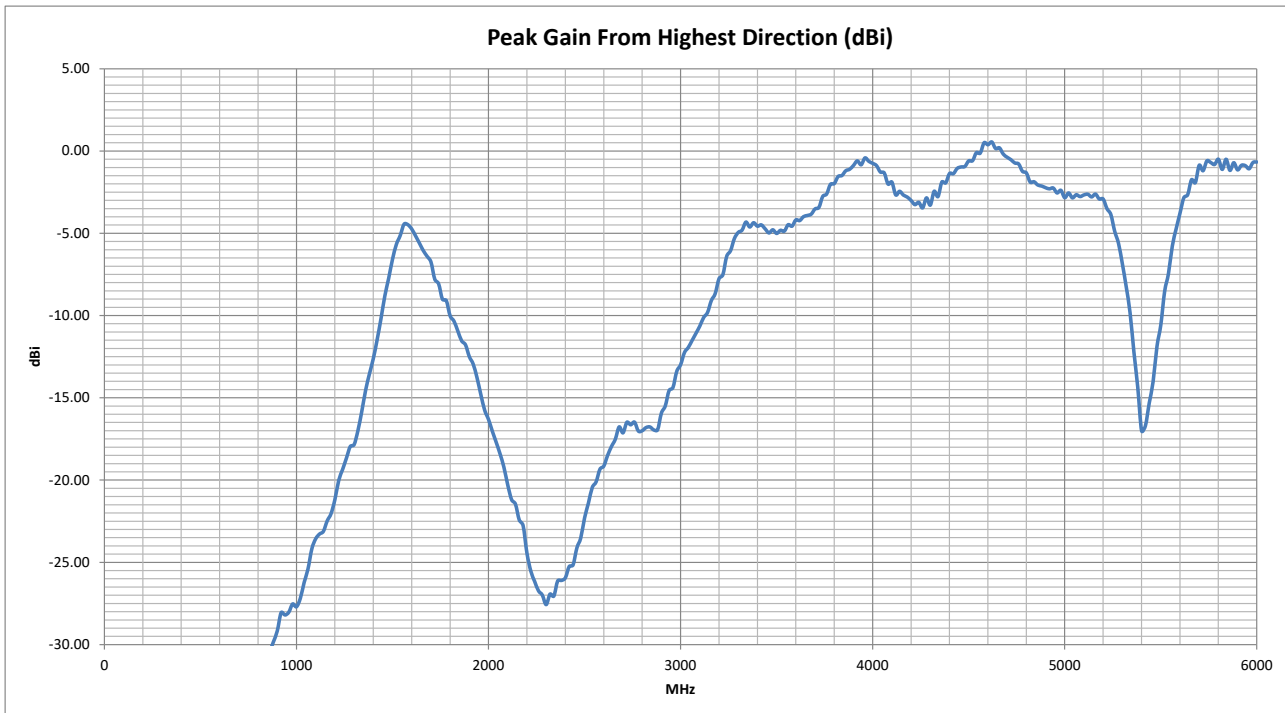

Return Loss

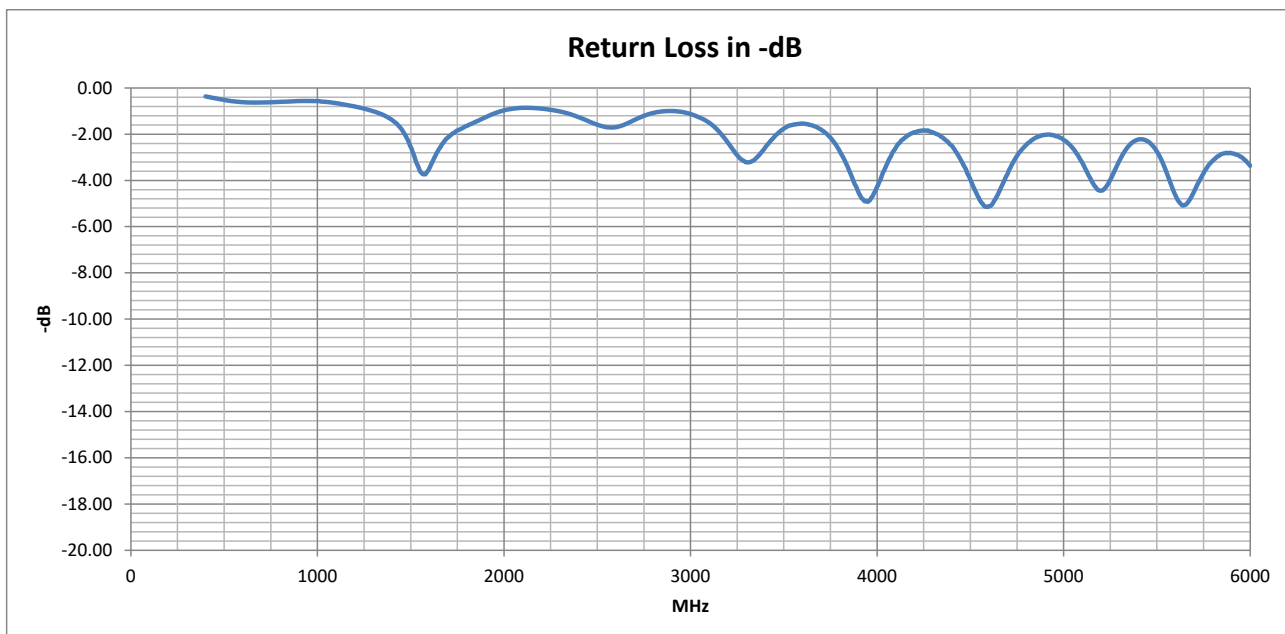



Tango 28

2.4 GHz Tiny Stubby Panel Mount Wi-Fi/Bluetooth/Zigbee Antenna

VSWR

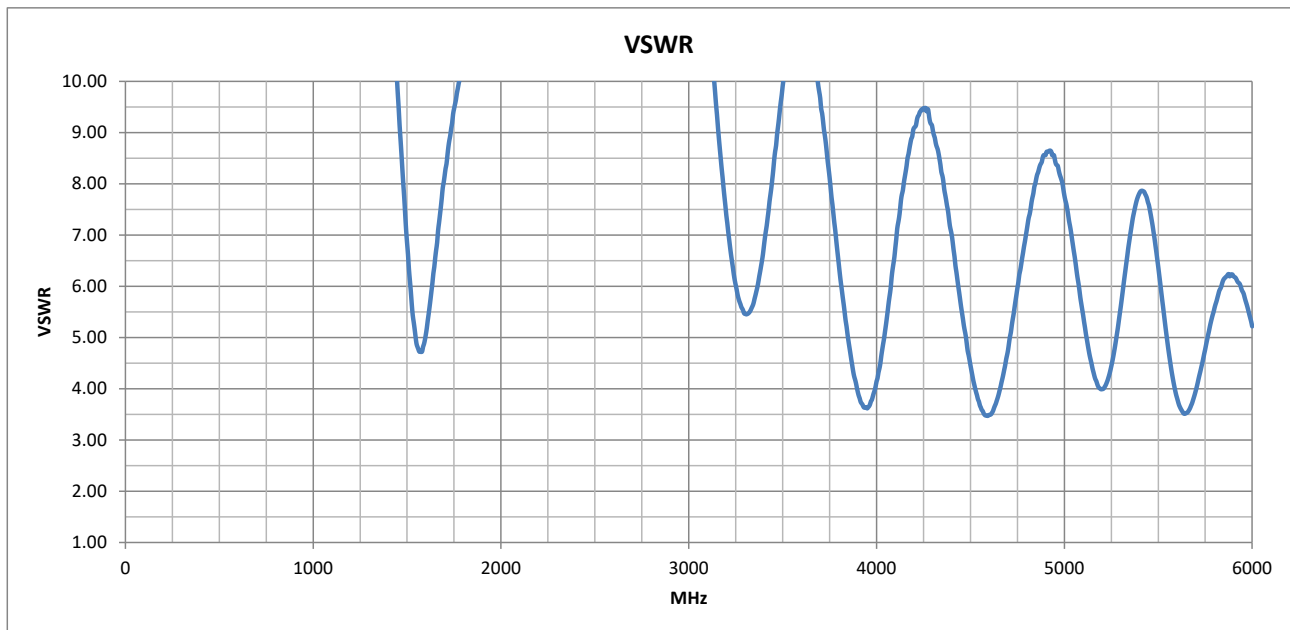

Radiation Efficiency

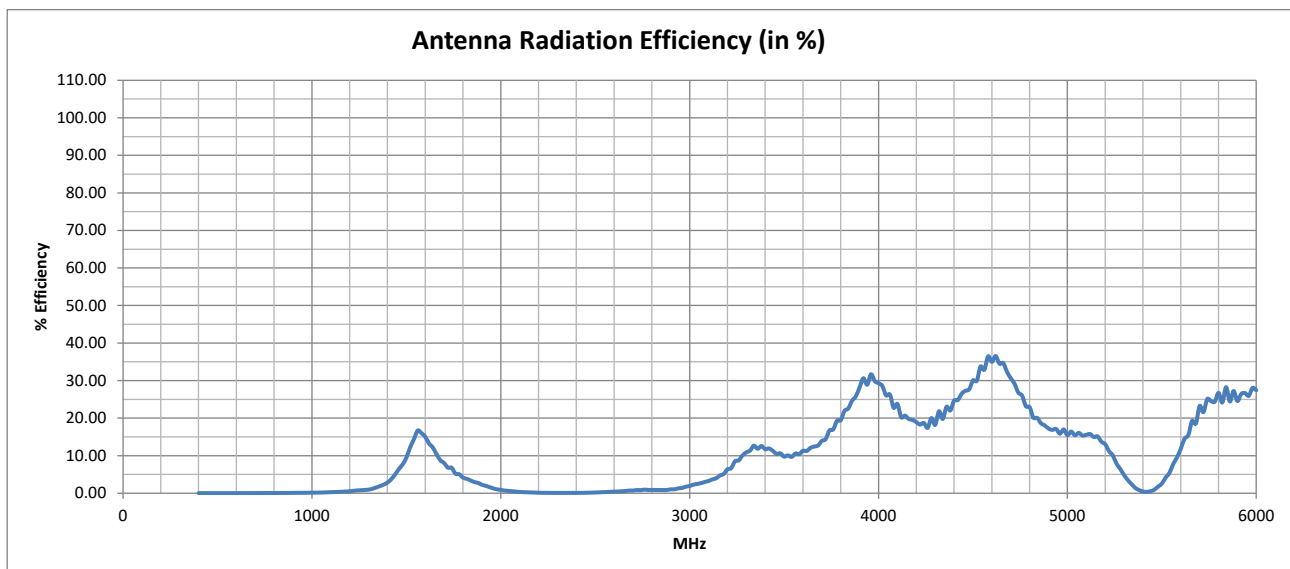



Tango 28

2.4 GHz Tiny Stubby Panel Mount Wi-Fi/Bluetooth/Zigbee Antenna

Cellular Standards Band Support

GSM (2G) Band	UMTS (3G) Band	E-UTRA (4G) Band	Cat M E-UTRA Band	Cat NB E-UTRA Band	NR (5G) Band	Cat NB NR (5G) Band	Uplink	Downlink	Average Upload Efficiency (%)	Average Download Efficiency (%)	Maximum Upload VSWR	Maximum Download VSWR	Use Indicator
	1	1	1	1	n1	n1	1920 - 1980 MHz	2110 - 2170 MHz	39.90	45.79	6.18	5.35	●
PCS-1900	2	2	2	2	n2	n2	1850 - 1910 MHz	1930 - 1990 MHz	48.19	39.22	4.82	6.22	●
DCS-1800	3	3	3	3	n3	n3	1710 - 1785 MHz	1805 - 1880 MHz	62.13	52.72	3.12	3.92	●
	4	4	4	4			1710 - 1755 MHz	2110 - 2155 MHz	62.77	44.48	3.12	5.35	●
GSM-850	5	5	5	5	n5	n5	824 - 849 MHz	869 - 894 MHz	19.99	18.50	5.75	9.90	●
	6						830 - 840 MHz	875 - 885 MHz	20.10	18.37	5.48	8.97	●
	7	7	7	7	n7	n7	2500 - 2570 MHz	2620 - 2690 MHz	67.44	46.20	3.23	5.93	●
E-GSM-900	8	8	8	8	n8	n8	880 - 915 MHz	925 - 960 MHz	19.33	17.73	11.43	14.86	●
	9	9					1749.9 - 1784.9 MHz	1844.9 - 1879.9 MHz	61.06	49.30	1.65	3.92	●
	10	10					1710 - 1770 MHz	2110 - 2170 MHz	61.75	45.79	3.12	5.35	●
	11	11	11	11			1427.9 - 1447.9 MHz	1475.9 - 1495.9 MHz	20.10	17.66	11.73	10.14	●
	12	12	12	12	n12	n12	699 - 716 MHz	729 - 746 MHz	31.77	30.10	7.54	7.72	●
	13	13	13	13	n13	n13	777 - 787 MHz	746 - 756 MHz	30.39	30.51	7.10	7.55	●
	14	14	14	14	n14		788 - 798 MHz	758 - 768 MHz	28.49	31.00	6.56	7.48	●
		17		17			704 - 716 MHz	734 - 746 MHz	31.59	30.02	7.54	7.72	●
		18	18	18	n18	n18	815 - 830 MHz	860 - 875 MHz	21.82	18.09	5.28	7.89	●
	19	19	19	19			830 - 845 MHz	875 - 890 MHz	19.82	18.50	5.60	9.51	●
	20	20	20	20	n20	n20	832 - 862 MHz	791 - 821 MHz	18.99	25.56	6.63	6.38	●
	21	21	21	21			1447.9 - 1462.9 MHz	1495.9 - 1510.9 MHz	20.97	16.70	10.37	10.39	●
	22	22					3410 - 3490 MHz	3510 - 3590 MHz	48.78	52.62	4.58	4.09	●
		24	24	24	n24		1626.5 - 1660.5 MHz	1525 - 1559 MHz	36.69	17.92	7.68	10.49	●
	25	25	25	25	n25	n25	1850 - 1915 MHz	1930 - 1995 MHz	47.90	39.24	4.94	6.27	●
	26	26	26	26	n26		814 - 849 MHz	859 - 894 MHz	20.68	18.36	5.75	9.90	●
		27	27				807 - 824 MHz	852 - 869 MHz	23.26	18.14	5.58	7.16	●
		28	28	28	n28	n28	703 - 748 MHz	758 - 803 MHz	30.75	29.82	7.72	7.48	●

● Suitable band

● Adequate band in good signal conditions

● Likely to be unsuitable



Tango 28

2.4 GHz Tiny Stubby Panel Mount Wi-Fi/Bluetooth/Zigbee Antenna

Cellular Standards Band Support

GSM (2G) Band	UMTS (3G) Band	E-UTRA (4G) Band	Cat M E-UTRA Band	Cat NB E-UTRA Band	NR (5G) Band	Cat NB NR (5G) Band	Uplink	Downlink	Average Upload Efficiency (%)	Average Download Efficiency (%)	Maximum Upload VSWR	Maximum Download VSWR	Use Indicator
		28A					703 - 733 MHz	758 - 788 MHz	31.09	30.72	7.71	7.48	●
		29			n29		N/A	717 - 728 MHz	N/A	30.78	N/A	7.70	●
		30			n30		2305 - 2315 MHz	2350 - 2360 MHz	70.90	76.15	1.69	1.28	●
		31	31	31			452.5 - 457.5 MHz	462.5 - 467.5 MHz	39.05	41.04	7.61	5.60	●
	32	32					N/A	1452 - 1496 MHz	N/A	19.08	N/A	10.15	●
		33					1900 - 1920 MHz	1900 - 1920 MHz	44.69	44.69	5.04	5.04	●
		34			n34		2010 - 2025 MHz	2010 - 2025 MHz	41.16	41.16	6.43	6.43	●
		35					1850 - 1910 MHz	1850 - 1910 MHz	48.19	48.19	4.82	4.82	●
		36					1930 - 1990 MHz	1930 - 1990 MHz	39.22	39.22	6.22	6.22	●
		37					1910 - 1930 MHz	1910 - 1930 MHz	43.39	43.39	5.36	5.36	●
		38			n38		2570 - 2620 MHz	2570 - 2620 MHz	52.84	52.84	4.26	4.26	●
		39	39		n39		1880 - 1920 MHz	1880 - 1920 MHz	46.41	46.41	5.04	5.04	●
		40	40		n40		2300 - 2400 MHz	2300 - 2400 MHz	73.64	73.64	1.76	1.76	●
		41	41	41	n41	n41	2496 - 2690 MHz	2496 - 2690 MHz	56.10	56.10	5.93	5.93	●
		42	42	42			3400 - 3600 MHz	3400 - 3600 MHz	50.63	50.63	4.61	4.61	●
		43	43	43			3600 - 3800 MHz	3600 - 3800 MHz	66.18	66.18	3.87	3.87	●
		44					703 - 803 MHz	703 - 803 MHz	30.32	30.32	7.72	7.72	●
		45					1447 - 1467 MHz	1447 - 1467 MHz	20.84	20.84	10.42	10.42	●
		46			n46		5150 - 5925 MHz	5150 - 5925 MHz	63.49	63.49	2.97	2.97	●
		47			n47		5855 - 5925 MHz	5855 - 5925 MHz	69.30	69.30	1.96	1.96	●
		48			n48		3550 - 3700 MHz	3550 - 3700 MHz	58.81	58.81	3.89	3.89	●
		49					3550 - 3700 MHz	3550 - 3700 MHz	58.81	58.81	3.89	3.89	●
		50			n50		1432 - 1517 MHz	1432 - 1517 MHz	18.80	18.80	11.48	11.48	●
		51			n51		1427 - 1432 MHz	1427 - 1432 MHz	18.96	18.96	11.77	11.77	●
		52					3300 - 3400 MHz	3300 - 3400 MHz	50.99	50.99	4.65	4.65	●

● Suitable band

● Adequate band in good signal conditions

● Likely to be unsuitable



Tango 28

2.4 GHz Tiny Stubby Panel Mount Wi-Fi/Bluetooth/Zigbee Antenna

Cellular Standards Band Support

GSM (2G) Band	UMTS (3G) Band	E-UTRA (4G) Band	Cat M E-UTRA Band	Cat NB E-UTRA Band	NR (5G) Band	Cat NB NR (5G) Band	Uplink	Downlink	Average Upload Efficiency (%)	Average Download Efficiency (%)	Maximum Upload VSWR	Maximum Download VSWR	Use Indicator
		53			n53		2483.5 - 2495 MHz	2483.5 - 2495 MHz	69.43	69.43	2.11	2.11	●
		65		65	n65	n65	1920 - 2010 MHz	2110 - 2200 MHz	39.85	48.97	6.43	5.35	●
		66	66	66	n66	n66	1710 - 1780 MHz	2110 - 2200 MHz	61.95	48.97	3.12	5.35	●
		67			n67		N/A	738 - 758 MHz	N/A	30.34	N/A	7.72	●
		68					698 - 728 MHz	753 - 783 MHz	31.41	30.88	7.70	7.55	●
		69					N/A	2570 - 2620 MHz	N/A	52.84	N/A	4.26	●
		70		70	n70	n70	1695 - 1710 MHz	1995 - 2020 MHz	59.30	40.75	3.80	6.43	●
		71	71	71	n71		663 - 698 MHz	617 - 652 MHz	35.25	41.95	7.66	7.52	●
		72	72	72			451 - 456 MHz	461 - 466 MHz	38.79	40.70	8.08	5.78	●
		73	73	73			450 - 455 MHz	460 - 465 MHz	38.62	40.47	8.39	5.89	●
		74	74	74	n74		1427 - 1470 MHz	1475 - 1518 MHz	20.37	17.15	11.77	10.47	●
		75			n75		N/A	1432 - 1517 MHz	N/A	18.80	N/A	11.48	●
		76			n76		N/A	1427 - 1432 MHz	N/A	18.96	N/A	11.77	●
					n77		3300 - 4200 MHz	3300 - 4200 MHz	61.17	61.17	4.65	4.65	●
					n78		3300 - 3800 MHz	3300 - 3800 MHz	56.92	56.92	4.65	4.65	●
					n79		4400 - 5000 MHz	4400 - 5000 MHz	51.10	51.10	5.77	5.77	●
					n80		1710 - 1785 MHz	N/A	62.13	N/A	3.12	N/A	●
					n81		880 - 915 MHz	N/A	19.33	N/A	11.43	N/A	●
					n82		832 - 862 MHz	N/A	18.99	N/A	6.63	N/A	●
					n83		703 - 748 MHz	N/A	30.75	N/A	7.72	N/A	●
					n84		1920 - 1980 MHz	N/A	39.90	N/A	6.18	N/A	●
		85	85	85	n85		698 - 716 MHz	728 - 746 MHz	31.81	30.12	7.54	7.72	●
					n86		1710 - 1780 MHz	N/A	61.95	N/A	3.12	N/A	●
		87	87	87			410 - 415 MHz	420 - 425 MHz	34.49	36.99	20.73	17.92	●
		88	88	88			412 - 417 MHz	422 - 427 MHz	35.18	36.93	19.94	17.11	●

● Suitable band

● Adequate band in good signal conditions

● Likely to be unsuitable



Cellular Standards Band Support

GSM (2G) Band	UMTS (3G) Band	E-UTRA (4G) Band	Cat M E-UTRA Band	Cat NB E-UTRA Band	NR (5G) Band	Cat NB NR (5G) Band	Uplink	Downlink	Average Upload Efficiency (%)	Average Download Efficiency (%)	Maximum Upload VSWR	Maximum Download VSWR	Use Indicator
					n89		824 - 849 MHz	N/A	19.99	N/A	5.75	N/A	●
					n90	n90	2496 - 2690 MHz	2496 - 2690 MHz	56.10	56.10	5.93	5.93	●
					n91		832 - 862 MHz	1427 - 1432 MHz	18.99	18.96	6.63	11.77	●
					n92		832 - 862 MHz	1432 - 1517 MHz	18.99	18.80	6.63	11.48	●
					n93		880 - 915 MHz	1427 - 1432 MHz	19.33	18.96	11.43	11.77	●
					n94		880 - 915 MHz	1432 - 1517 MHz	19.33	18.80	11.43	11.48	●
					n95		2010 - 2025 MHz	N/A	41.16	N/A	6.43	N/A	●
					n97		2300 - 2400 MHz	N/A	73.64	N/A	1.76	N/A	●
					n98		1880 - 1920 MHz	N/A	46.41	N/A	5.04	N/A	●
					n99		1626.5 - 1660.5 MHz	N/A	36.69	N/A	7.68	N/A	●
					n101		1900 - 1910 MHz	1900 - 1910 MHz	45.30	45.30	4.82	4.82	●
				103			787 - 788 MHz	757 - 758 MHz	29.48	30.90	6.63	7.50	●

● Suitable band

● Adequate band in good signal conditions

● Likely to be unsuitable

NOTE: For each frequency band, Siretta provides a traffic light indication to show the suitability of the antenna for use at that frequency band. Determination of exactly what makes an antenna good or bad at any frequency is subjective.

The view presented is that of Siretta's engineering team having taken into account the efficiency and VSWR measurements. The end user is advised to use their own criteria and/or testing to confirm suitability.



Tango 28

2.4 GHz Tiny Stubby Panel Mount Wi-Fi/Bluetooth/Zigbee Antenna

ISM Standards Frequency Support

Application	Frequency Range	Efficiency (%)	Maximum VSWR	Peak Gain from highest direction (dBi)	Use Indicator
ISM 433 MHz	433.05 - 434.79 MHz	36.66	14.11	-0.109	●
ISM 868 MHz	863 - 870 MHz	18.07	7.23	-1.315	●
ISM 915 MHz	902 - 928 MHz	20.21	12.49	0.24	●
ISM 2.4 GHz	2400 - 2500 MHz	69.31	2.19	3.49	●
Wi-Fi 2.4G	2401 - 2483 MHz	69.12	2.04	3.483	●
Wi-Fi 2.4G (USA)	2401 - 2473 MHz	69.36	1.93	3.483	●
Wi-Fi 2.4G (Japan)	2401 - 2495 MHz	69.16	2.11	3.483	●
Wi-Fi 5G (all channels)	5150 - 5990 MHz	63.83	2.97	4.33	●
Wi-Fi 5G (Ch 32-48)	5150 - 5250 MHz	69.58	2.15	4.33	●
Wi-Fi 5G (Ch 32-64)	5150 - 5330 MHz	66.34	2.39	4.33	●
Wi-Fi 5G (Ch 32-161)	5150 - 5815 MHz	62.48	2.97	4.33	●
Wi-Fi 5G (Ch 32-173)	5150 - 5875 MHz	63.06	2.97	4.33	●
ISM 5.8 GHz	5725 - 5875 MHz	68.17	2.35	3.56	●

● Suitable band

● Adequate band in good signal conditions

● Likely to be unsuitable

NOTE: For each frequency band, Siretta provides a traffic light indication to show the suitability of the antenna for use at that frequency band. Determination of exactly what makes an antenna good or bad at any frequency is subjective.

The view presented is that of Siretta's engineering team having taken into account the efficiency and VSWR measurements. The end user is advised to use their own criteria and/or testing to confirm suitability.



Tango 28

2.4 GHz Tiny Stubby Panel Mount Wi-Fi/Bluetooth/Zigbee Antenna

2D Radiation Plots

1700 MHz XY

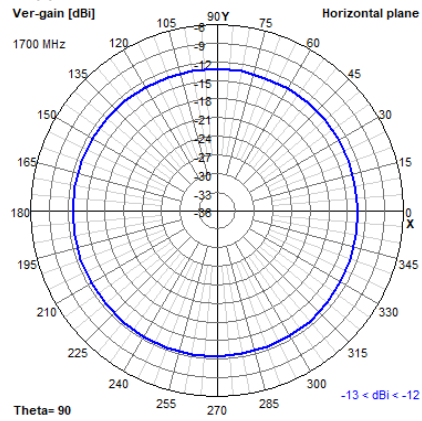

XZ

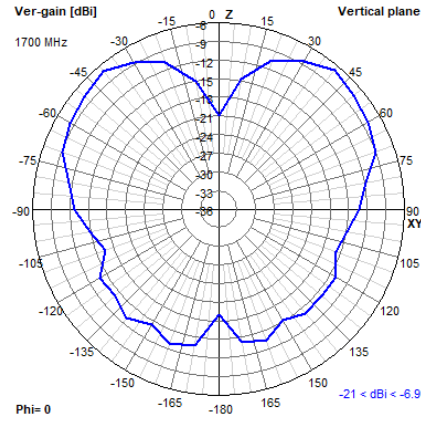

YZ

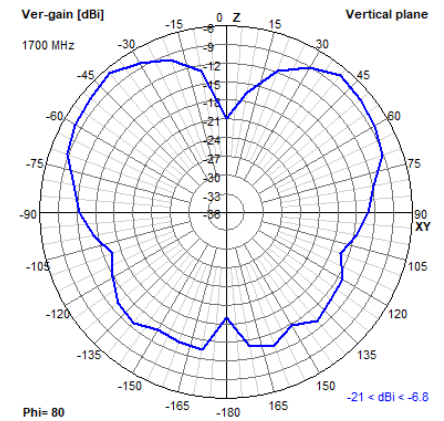

1800 MHz XY

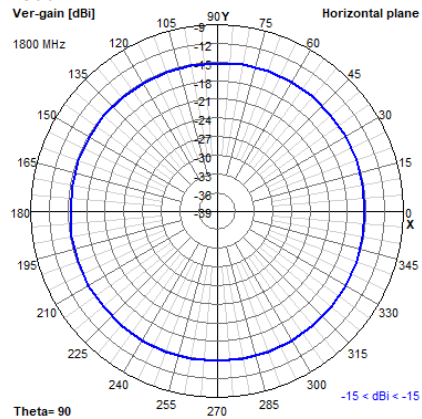

XZ

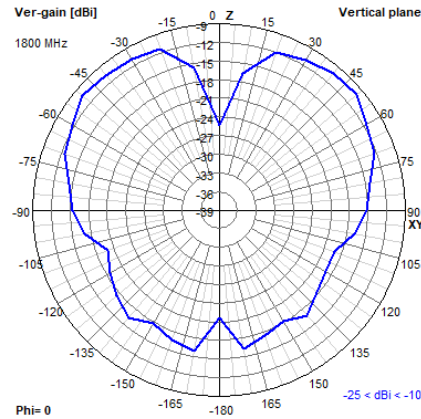

YZ

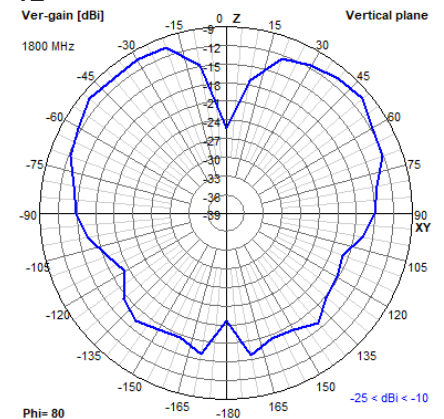

2300 MHz XY

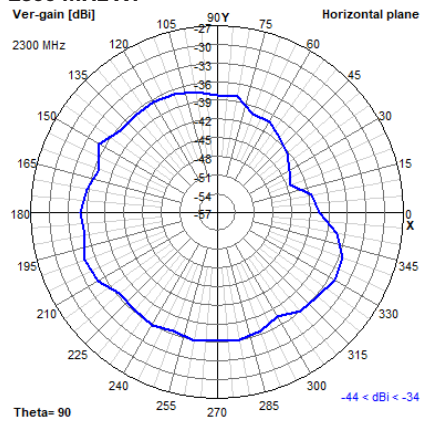

XZ

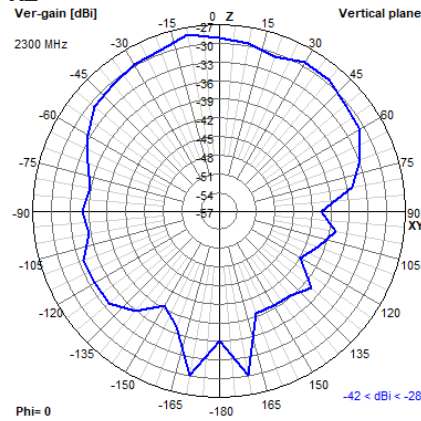

YZ

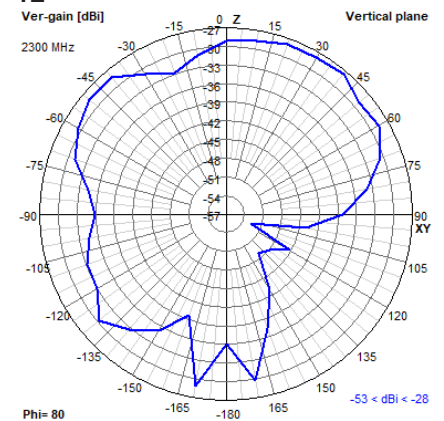



Tango 28

2.4 GHz Tiny Stubby Panel Mount Wi-Fi/Bluetooth/Zigbee Antenna

2D Radiation Plots

2400 MHz XY

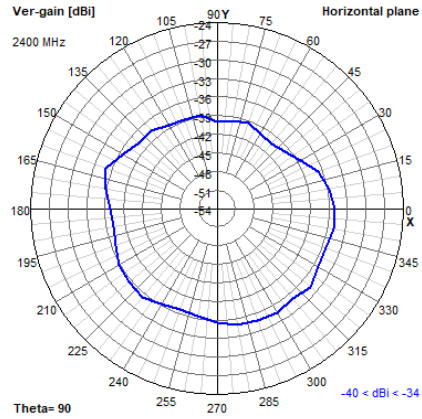

XZ

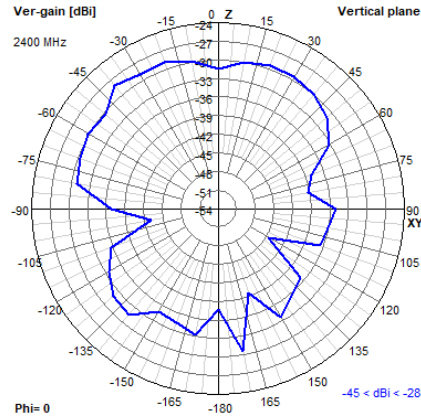

YZ

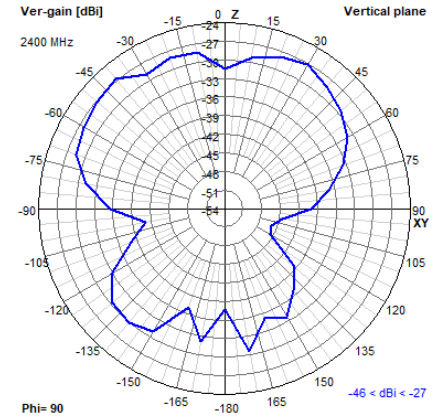

2600 MHz XY

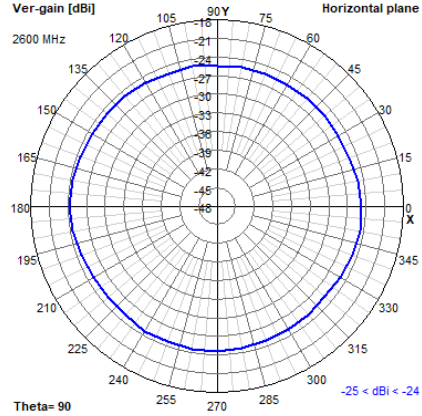

XZ

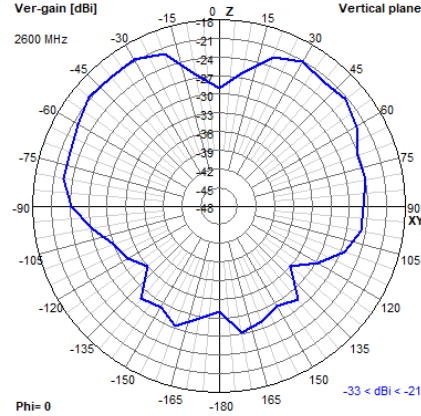

YZ

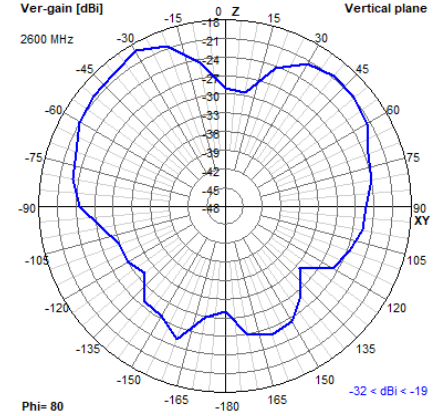

3500 MHz XY

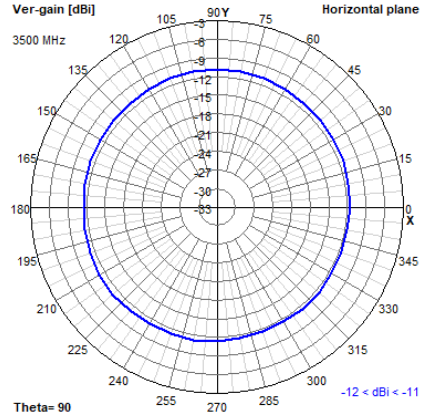

XZ

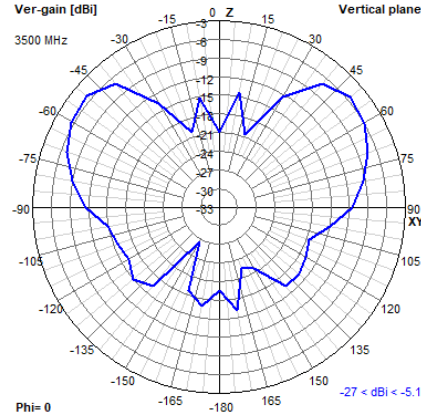

YZ

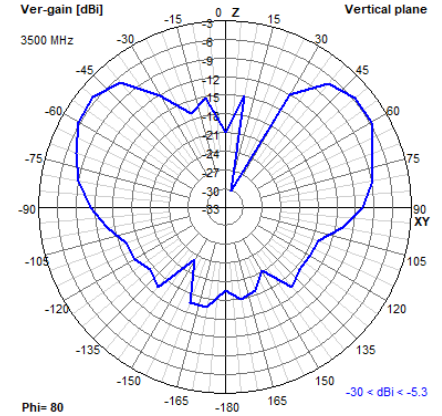



Tango 28

2.4 GHz Tiny Stubby Panel Mount Wi-Fi/Bluetooth/Zigbee Antenna

2D Radiation Plots

3700 MHz XY

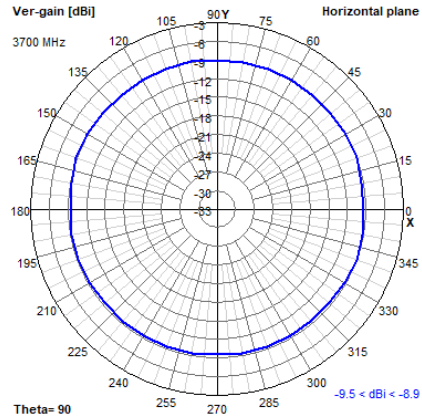

XZ

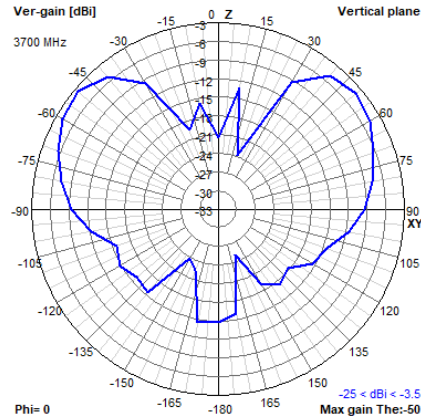

YZ

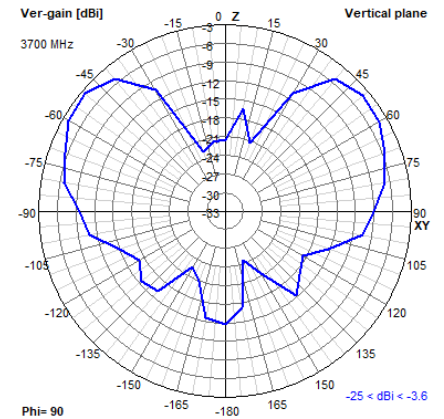

5200 MHz XY

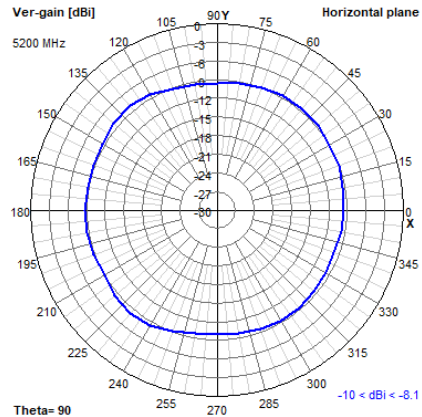

XZ

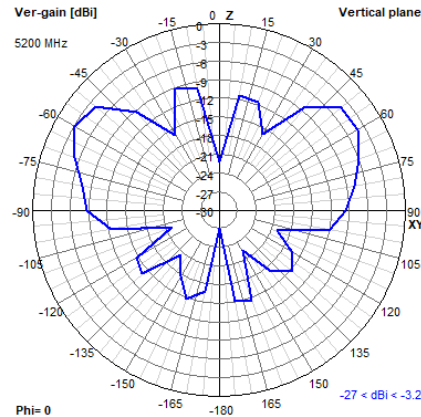

YZ

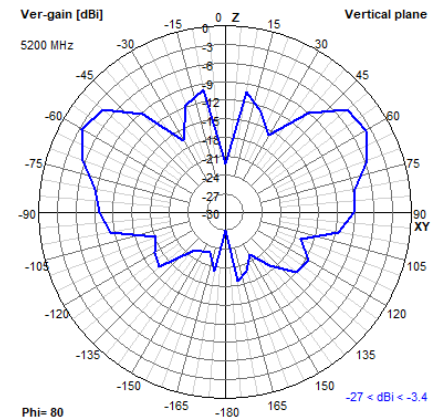

5500 MHz XY

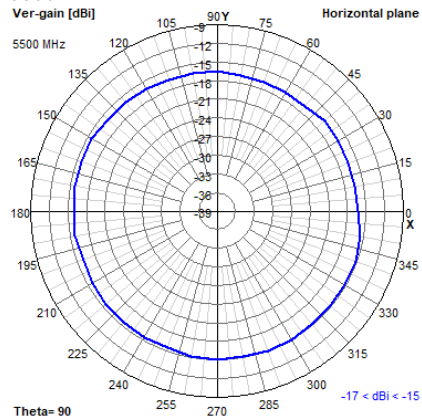

XZ

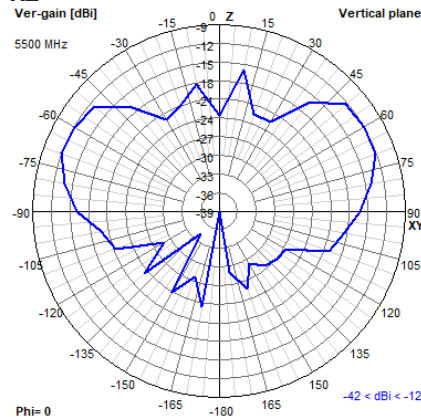

YZ

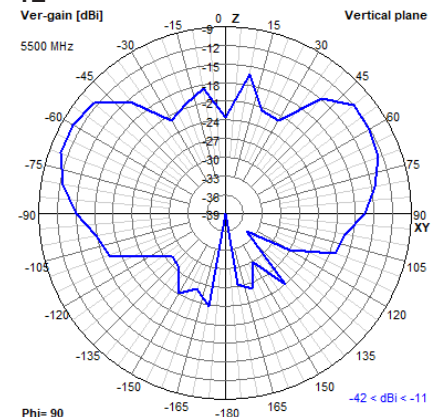



Tango 28

2.4 GHz Tiny Stubby Panel Mount Wi-Fi/Bluetooth/Zigbee Antenna

2D Radiation Plots

5800 MHz XY

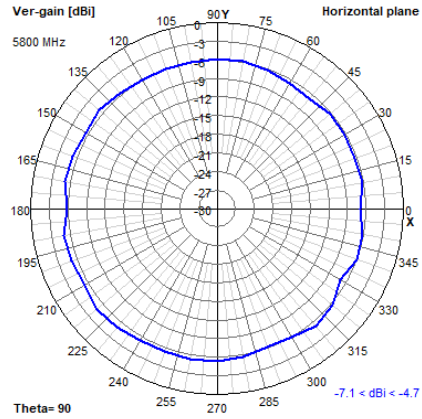

XZ

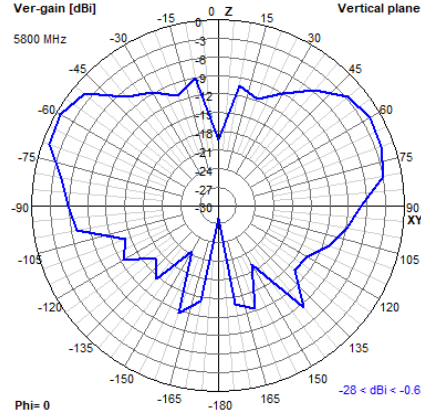

YZ

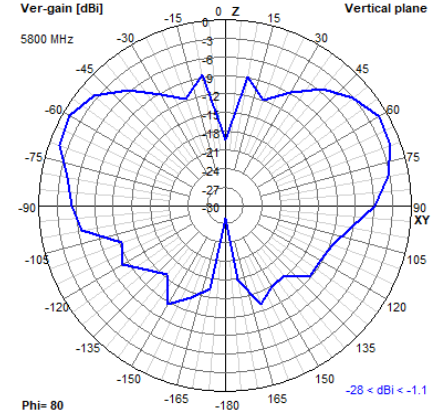

5900 MHz XY

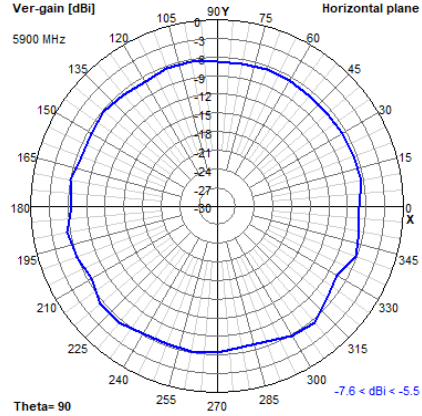

XZ

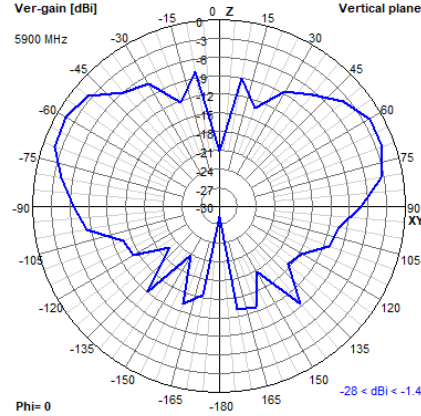

YZ

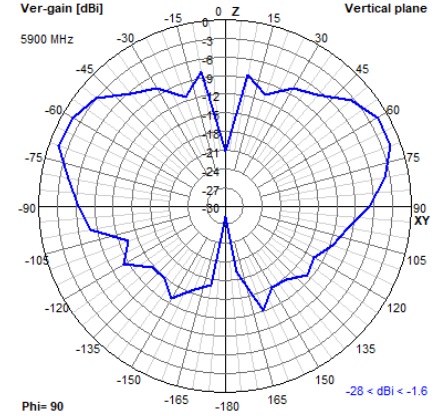



Tango 28

2.4 GHz Tiny Stubby Panel Mount Wi-Fi/Bluetooth/Zigbee Antenna

3D Radiation Plots

1700 MHz

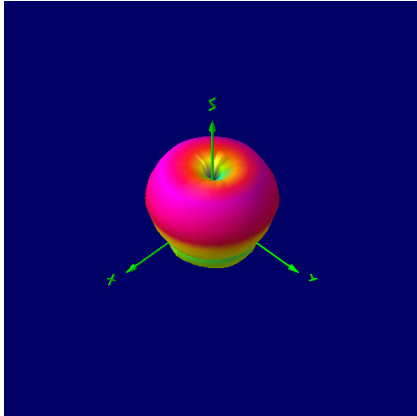

1800 MHz

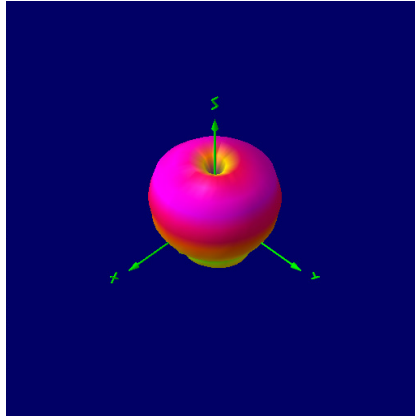

2300 MHz

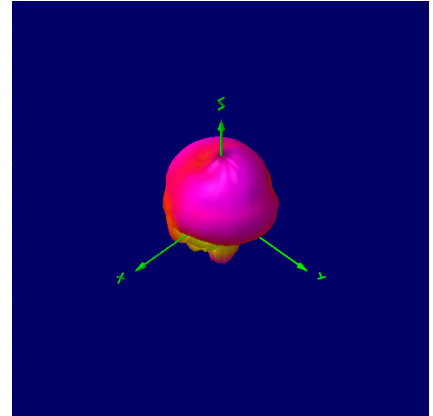

2400 MHz

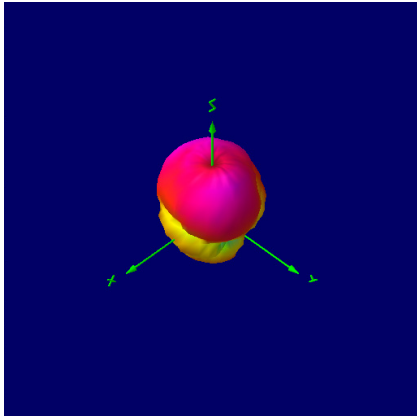

2600 MHz

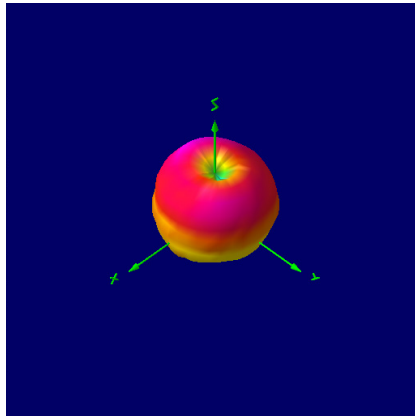

3500 MHz

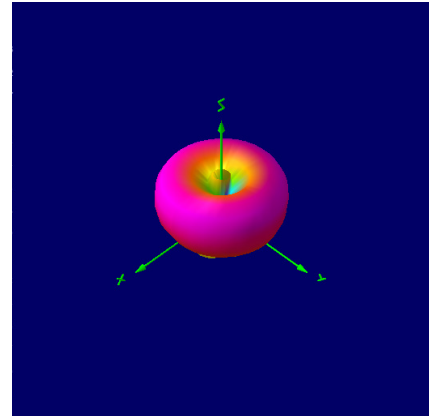

3700 MHz

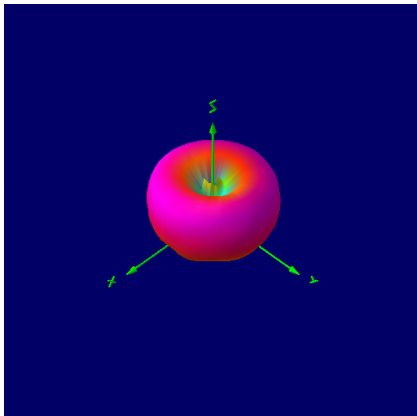

5200 MHz

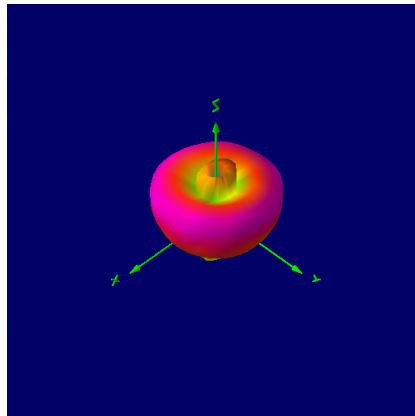

5500 MHz

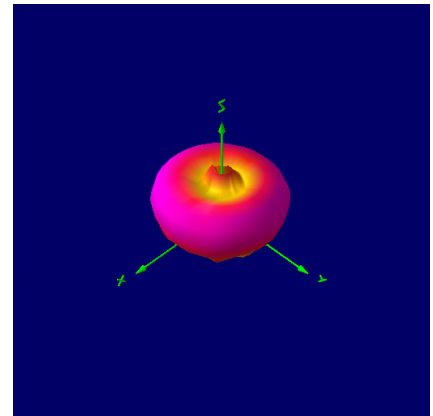

3D Radiation Plots

5800 MHz

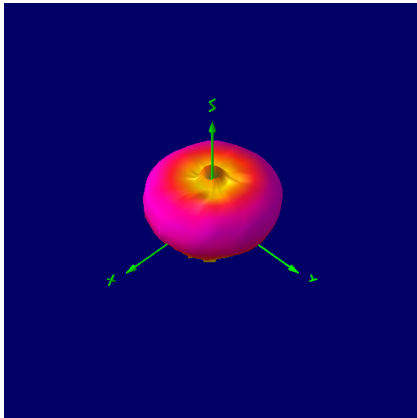

5900 MHz

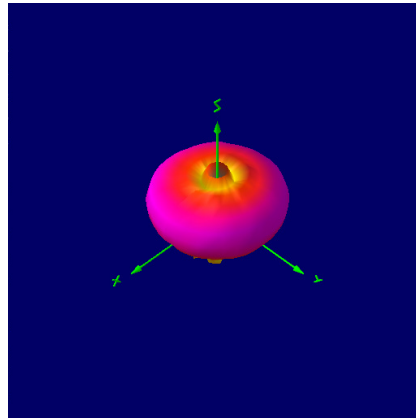

NOTE: All 3D radiation plots are shown with Theta = 45 and Phi = 45.

Ordering Details:

Part Number	Description
TANGO28/0.1M/I-PEX/S/S/35	2.4 GHz Tiny Stubby Panel Mount Wi-Fi/Bluetooth/Zigbee Antenna 0.1M Cable I-PEX Connector
TANGO28/0.15M/I-PEX/S/S/35	2.4 GHz Tiny Stubby Panel Mount Wi-Fi/Bluetooth/Zigbee Antenna 0.15M Cable I-PEX Connector
TANGO28/0.1M/I-PEXMHF4/S/S/35	2.4 GHz Tiny Stubby Panel Mount Wi-Fi/Bluetooth/Zigbee Antenna 0.1M Cable I-PEX MHF4 Connector
TANGO28/0.1M/SMAM/S/S/35	2.4 GHz Tiny Stubby Panel Mount Wi-Fi/Bluetooth/Zigbee Antenna 0.1M Cable SMA Male Connector

X-ON Electronics

Largest Supplier of Electrical and Electronic Components

Click to view similar products for [Antennas](#) category:

Click to view products by [SIRETTA](#) manufacturer:

Other Similar products are found below :

[930-033-R](#) [EXE902SM](#) [APAMPG-117](#) [MAF94383](#) [108-00014-50](#) [SPDA17RP918](#) [A09-F5NF-M](#) [RGFRA1903041A1T](#) [108-00016-050](#)
[W3921B0100](#) [SIMNA-868](#) [SIMNA-915](#) [SIMNA-433](#) [W1049B090](#) [TRABT1560](#) [W3118A](#) [WTL2449CQ1-FRSMM](#) [CPL9C](#) [0600-00060](#)
[GD5W-28P-NF](#) [PAL90209H-FNF](#) [MA9-7N](#) [GD53-25](#) [C37](#) [MAF94051](#) [S9025PLSMF](#) [EXD420PL](#) [B1322NR](#) [MAF94300](#) [GPSMB301](#)
[FG4403](#) [MIKROE-2393](#) [DA5-32RADOME](#) [BB1442NR](#) [5200227](#) [GPSCPMM00](#) [ANTDOM-05-01-WPM](#) [ANT-WP868SMA-Y](#)
[EXW30BNX](#) [OSCAR1A/5M/SMAM/S/S/31](#) [ALPHA4A/1M/SMAM/S/S/26](#) [OSCAR1A/10M/SMAM/S/S/31](#) [OSCAR1A/20M/SMAM/S/S/31](#)
[OSCAR40/5M/LL/SMAM/S/S/33](#) [TANGO41/1M/SMAM/S/S/32](#) [ANTX100ETBAB24553](#) [S4908WBFNM](#) [FXR.01.07.0100C.A](#) [GD57-21](#)
[001-0016](#)