

## Features

- Any frequency between 1 MHz and 80 MHz with 6 decimal places of accuracy
- 100% pin-to-pin drop-in replacement to quartz-based VCXO
- Frequency stability as tight as  $\pm 10$  ppm
- Widest pull range options from  $\pm 25$  ppm to  $\pm 1600$  ppm
- Industrial or extended commercial temperature range
- Superior pull range linearity of  $\leq 1\%$ , 10 times better than quartz
- LVC MOS/LVTTL compatible output
- Four industry-standard packages: 2.5 mm x 2.0 mm (4-pin), 3.2 mm x 2.5 mm (4-pin), 5.0 mm x 3.2 mm (6-pin), 7.0 mm x 5.0 mm (6-pin)
- Instant samples with [Time Machine II](#) and [field programmable oscillators](#)
- RoHS and REACH compliant, Pb-free, Halogen-free and Antimony-free

## Applications

- Telecom clock synchronization, instrumentation
- Low bandwidth analog PLL, jitter cleaner, clock recovery, audio
- Video, 3G/HD-SDI, FPGA, broadband and networking

INSTANT  
SAMPLESGREEN  
SOLUTIONSLIFETIME  
WARRANTY

## Electrical Specifications

Table 1. Electrical Characteristics<sup>[1, 2, 3]</sup>

Parameter	Symbol	Min.	Typ.	Max.	Unit	Condition
<b>Frequency Range</b>						
Output Frequency Range	f	1	–	80	MHz	
<b>Frequency Stability and Aging</b>						
Frequency Stability	F_stab	-10	–	+10	ppm	Inclusive of Initial tolerance <sup>[4]</sup> at 25 °C, and variation over temperature, rated supply voltage and load.
		-25	–	+25	ppm	
		-50	–	+50	ppm	
Aging	F_aging	-5	–	+5	ppm	10 years, 25°C
Operating Temperature Range	T_use	-20	–	+70	°C	Extended Commercial
		-40	–	+85	°C	Industrial
<b>Supply Voltage and Current Consumption</b>						
Supply Voltage	Vdd	1.71	1.8	1.89	V	Additional supply voltages between 2.5V and 3.3V can be supported. Contact <a href="#">SiTime</a> for additional information.
		2.25	2.5	2.75	V	
		2.52	2.8	3.08	V	
		2.97	3.3	3.63	V	
Current Consumption	Idd	–	31	33	mA	No load condition, f = 20 MHz, Vdd = 2.5V, 2.8V or 3.3V
		–	29	31	mA	No load condition, f = 20 MHz, Vdd = 1.8V
Standby Current	I_std	–	–	70	μA	Vdd = 2.5V, 2.8V, 3.3V, $\overline{ST}$ = GND, output is Weakly Pulled Down
		–	–	10	μA	Vdd = 1.8V, $\overline{ST}$ = GND, output is Weakly Pulled Down
<b>VCXO Characteristics</b>						
Pull Range <sup>[5, 6]</sup>	PR	±25, ±50, ±100, ±150, ±200, ±400, ±800, ±1600			ppm	See the Absolute Pull Range and APR table on <a href="#">page 10</a>
Upper Control Voltage	VC_U	1.7	–	–	V	Vdd = 1.8V, Voltage at which maximum deviation is guaranteed.
		2.4	–	–	V	Vdd = 2.5V, Voltage at which maximum deviation is guaranteed.
		2.7	–	–	V	Vdd = 2.8V, Voltage at which maximum deviation is guaranteed.
		3.2	–	–	V	Vdd = 3.3V, Voltage at which maximum deviation is guaranteed.
Lower Control Voltage	VC_L	–	–	0.1	V	Voltage at which minimum deviation is guaranteed.
Control Voltage Input Impedance	Z_in	100	–	–	kΩ	
Control Voltage Input Capacitance	C_in	–	5	–	pF	
Linearity	Lin	–	0.1	1	%	
Frequency Change Polarity	–	Positive slope			–	
Control Voltage Bandwidth (-3dB)	V_BW	–	8	–	kHz	Contact SiTime for 16 kHz and other high bandwidth options

# SiT3808

## 1 MHz to 80 MHz High Performance MEMS VCXO

### Electrical Specifications (continued)

Table 1. Electrical Characteristics<sup>[1, 2, 3]</sup>

Parameter	Symbol	Min.	Typ.	Max.	Unit	Condition
<b>LVC MOS Output Characteristics</b>						
Duty Cycle	DC	45	–	55	%	All Vdds. Refer to Note 11 for definition of Duty Cycle
Rise/Fall Time	Tr, Tf	–	1.5	2	ns	Vdd = 1.8V, 2.5V, 2.8V or 3.3V, 10% - 90% Vdd level
Output High Voltage	VOH	90%	–	–	Vdd	I <sub>OH</sub> = -7 mA (Vdd = 3.0V or 3.3V) I <sub>OH</sub> = -4 mA (Vdd = 2.8V or 2.5V) I <sub>OH</sub> = -2 mA (Vdd = 1.8V)
Output Low Voltage	VOL	–	–	10%	Vdd	I <sub>OL</sub> = 7 mA (Vdd = 3.0V or 3.3V) I <sub>OL</sub> = 4 mA (Vdd = 2.8V or 2.5V) I <sub>OL</sub> = 2 mA (Vdd = 1.8V)
<b>Input Characteristics</b>						
Input Pull-up Impedance	Z <sub>in</sub>	–	100	250	kΩ	For the OE/ $\overline{\text{ST}}$ pin for 6-pin devices
Input Capacitance	C <sub>in</sub>	–	5	–	pF	For the OE/ $\overline{\text{ST}}$ pin for 6-pin devices
<b>Startup and Resume Timing</b>						
Startup Time	T <sub>start</sub>	–	–	10	ms	See Figure 7 for startup resume timing diagram
OE Enable/Disable Time	T <sub>oe</sub>	–	–	180	ns	f = 40 MHz, all Vdds. For other freq, T <sub>oe</sub> = 100 ns + 3 clock periods
Resume Time	T <sub>resume</sub>	–	7	10	ms	See Figure 8 for resume timing diagram
<b>Jitter</b>						
RMS Period Jitter	T <sub>jitt</sub>	–	1.5	2	ps	f = 20 MHz, Vdd = 2.5V, 2.8V or 3.3V
		–	2	3	ps	f = 20 MHz, Vdd = 1.8V
RMS Phase Jitter (random)	T <sub>phj</sub>	–	0.5	1	ps	f = 20 MHz, Integration bandwidth = 12 kHz to 20 MHz, All Vdds

**Notes:**

- All electrical specifications in the above table are specified with 15 pF output load and for all Vdd(s) unless otherwise stated.
- The typical value of any parameter in the Electrical Characteristics table is specified for the nominal value of the highest voltage option for that parameter and at 25°C temperature.
- All max and min specifications are guaranteed across rated voltage variations and operating temperature ranges, unless specified otherwise
- Initial tolerance is measured at Vin = Vdd/2
- Absolute Pull Range (APR) is defined as the guaranteed pull range over temperature and voltage.
- APR = pull range (PR) - frequency stability (F<sub>stab</sub>) - Aging (F<sub>aging</sub>)

# SiT3808

## 1 MHz to 80 MHz High Performance MEMS VCXO

**Table 2. Pin Description. 4-Pin Configuration**  
(For 2.5 x 2.0 mm and 3.2 x 2.5 mm packages)

Pin	Symbol		Functionality
1	VIN	Input	0-Vdd: produces voltage dependent frequency change
2	GND	Power	Electrical ground
3	CLK	Output	Oscillator output
4	VDD	Power	Power supply voltage <sup>[7]</sup>

**Note:**

7. A capacitor value of 0.1  $\mu$ F between VDD and GND is recommended.

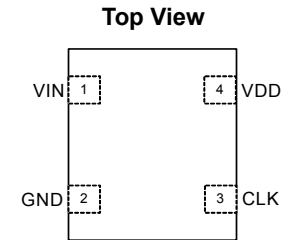

**Figure 1.**

**Table 3. Pin Description. 6-Pin Configuration**  
(For 5.0 x 3.2 mm and 7.0 x 5.0 mm packages)

Pin	Symbol		Functionality
1	VIN	Input	0-Vdd: produces voltage dependent frequency change
2	NC/OE/ $\overline{ST}$	No Connect	H or L or Open: No effect on output frequency or other device functions
		Output Enable	H or Open <sup>[8]</sup> : specified frequency output L: output is high
		Standby	H or Open <sup>[8]</sup> : specified frequency output L: output is low (weak pull down) <sup>[9]</sup> . Oscillation stops
3	GND	Power	Electrical ground
4	CLK	Output	Oscillator output
5	NC	No Connect	H or L or Open: No effect on output frequency or other device functions
6	VDD	Power	Power supply voltage <sup>[10]</sup>



**Figure 2.**

**Notes:**

- 8. In OE or ST mode, a pull-up resistor of 10 k $\Omega$  or less is recommended if pin 2 in the 6-pin package is not externally driven. If pin 2 needs to be left floating, use the NC option
- 9. Typical value of the weak pull-down impedance is 5 m $\Omega$
- 10. A capacitor value of 0.1  $\mu$ F between VDD and GND is recommended.

**Table 4. Absolute Maximum Limits**

Attempted operation outside the absolute maximum ratings may cause permanent damage to the part. Actual performance of the IC is only guaranteed within the operational specifications, not at absolute maximum ratings.

Parameter	Min.	Max.	Unit
Storage Temperature	-65	150	$^{\circ}$ C
VDD	-0.5	4	V
Electrostatic Discharge	-	2000	V
Soldering Temperature (follow standard Pb free soldering guidelines)	-	260	$^{\circ}$ C

**Table 5. Thermal Consideration**

Parameter	$\theta$ JA, 4 Layer Board ( $^{\circ}$ C/W)	$\theta$ JA, 2 Layer Board ( $^{\circ}$ C/W)	$\theta$ JC, Bottom ( $^{\circ}$ C/W)
7050	191	263	30
5032	97	199	24
3225	109	212	27
2520	117	222	26

**Table 6. Environmental Compliance**

Parameter	Condition/Test Method
Mechanical Shock	MIL-STD-883F, Method 2002
Mechanical Vibration	MIL-STD-883F, Method 2007
Temperature Cycle	JESD22, Method A104
Solderability	MIL-STD-883F, Method 2003
Moisture Sensitivity Level	MSL1 @ 260 $^{\circ}$ C

**Phase Noise Plot**



**Figure 3. Phase Noise, 10 MHz, 3.3V, LVC MOS Output**

**Test Circuit and Waveform**



**Figure 4. Test Circuit (4-Pin Device)**



**Figure 5. Test Circuit (6-Pin Device)**



**Figure 6. Waveform**

**Note:**

11. Duty Cycle is computed as Duty Cycle = TH/Period.
12. SiT3808 supports the configurable duty cycle feature. For custom duty cycle at any given frequency, contact [SiTime](http://www.sitime.com).

**Timing Diagram**



**Figure 7. Startup Timing (OE/ST Mode)**



**Figure 8. Standby Resume Timing (ST Mode Only)**

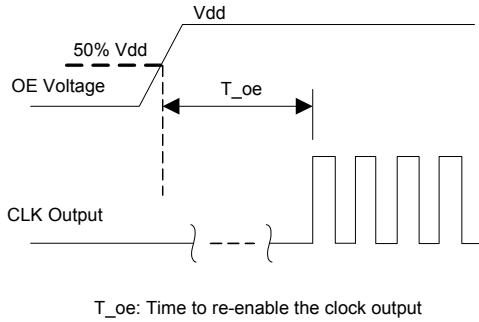

**Figure 9. OE Enable Timing (OE Mode Only)**

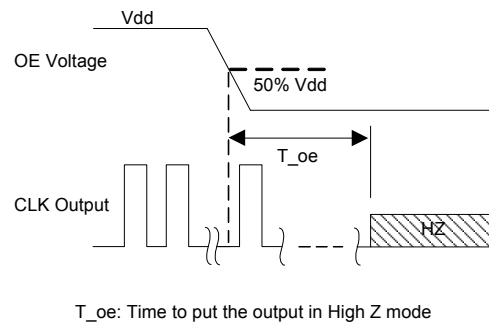

**Figure 10. OE Disable Timing (OE Mode Only)**

**Notes:**

- 13. SiT3808 supports “no runt” pulses and “no glitch” output during startup or resume.
- 14. SiT3808 supports gated output which is accurate within rated frequency stability from the first cycle.

### Programmable Drive Strength

The SiT3808 includes a programmable drive strength feature to provide a simple, flexible tool to optimize the clock rise/fall time for specific applications. Benefits from the programmable drive strength feature are:

- Improves system radiated electromagnetic interference (EMI) by slowing down the clock rise/fall time.
- Improves the downstream clock receiver's (RX) jitter by decreasing (speeding up) the clock rise/fall time.
- Ability to drive large capacitive loads while maintaining full swing with sharp edge rates.

For more detailed information about rise/fall time control and drive strength selection, see the SiTime Application Notes section; <http://www.sitime.com/support/application-notes>.

### EMI Reduction by Slowing Rise/Fall Time

Figure 11 shows the harmonic power reduction as the rise/fall times are increased (slowed down). The rise/fall times are expressed as a ratio of the clock period. For the ratio of 0.05, the signal is very close to a square wave. For the ratio of 0.45, the signal is very close to near-triangular waveform. These results, for example, show that the 11th clock harmonic can be reduced by 35 dB if the rise/fall edge is increased from 5% of the period to 45% of the period.

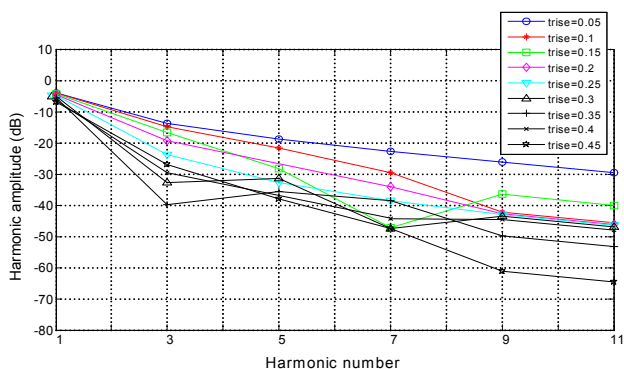

Figure 11. Harmonic EMI reduction as a Function of Slower Rise/Fall Time

### Jitter Reduction with Faster Rise/Fall Time

Power supply noise can be a source of jitter for the downstream chipset. One way to reduce this jitter is to increase rise/fall time (edge rate) of the input clock. Some chipsets would require faster rise/fall time in order to reduce their sensitivity to this type of jitter. Refer to the [Rise/Fall Time Tables](#) to determine the proper drive strength.

### High Output Load Capability

The rise/fall time of the input clock varies as a function of the actual capacitive load the clock drives. At any given drive strength, the rise/fall time becomes slower as the output load increases. As an example, for a 3.3V SiT3808 device with default drive strength setting, the typical rise/fall time is 1.15 ns for 15 pF output load. The typical rise/fall time slows down to 2.72 ns when the output load increases to 45 pF. One can choose to speed up the rise/fall time to 1.41 ns by then

increasing the drive strength setting to “P” (reference to the drive strength code in Table 10) on the SiT3808.

The SiT3808 can support up to 60 pF maximum capacitive loads. Refer to the [Rise/Fall Time Tables](#) to determine the proper drive strength for the desired combination of output load vs. rise/fall time.

### SiT3808 Drive Strength Selection

Tables 7 through 10 define the rise/fall times for a given capacitive load and supply voltage.

1. Select the table that matches the SiT3808 nominal supply voltage (1.8V, 2.5V, 2.8V, 3.3V).
2. Select the capacitive load column that matches the application requirement (5 pF to 60 pF)
3. Under the capacitive load column, select the desired rise/fall times.
4. The left-most column represents the part number code for the corresponding drive strength.
5. Add the drive strength code to the part number for ordering purposes.

### Calculating Maximum Frequency

Based on the rise and fall time data given in Tables 7 through 10, the maximum frequency the oscillator can operate with guaranteed full swing of the output voltage over temperature can be calculated as follows:

$$\text{Max Frequency} = \frac{1}{6 \times \text{Trf}_{10/90}}$$

Where  $\text{Trf}_{10/90}$  is the typical rise/fall time at 10% to 90% Vdd.

### Example 1

Calculate  $f_{\text{MAX}}$  for the following condition:

- Vdd = 3.3V (Table 10)
- Capacitive Load: 30 pF
- Typical Tr/f time = 1.66 ns (drive strength part number code = G)

Part number for the above example:

SiT3808AIGG2-33EH-49.152000



Drive strength code is inserted here. Default setting is “\_”

### Rise/Fall Time (10% to 90%) vs C<sub>LOAD</sub> Tables

Table 7. V<sub>dd</sub> = 1.8V Rise/Fall Times for Specific C<sub>LOAD</sub>

Rise/Fall Time Typ (ns)					
Drive Strength \ C <sub>LOAD</sub>	5 pF	15 pF	30 pF	45 pF	60 pF
L	12.45	17.68	19.48	46.21	57.82
A	6.50	10.27	16.21	23.92	30.73
R	4.38	7.05	11.61	16.17	20.83
B	3.27	5.30	8.89	12.18	15.75
S	2.62	4.25	7.20	9.81	12.65
D	2.19	3.52	6.00	8.31	10.59
T	1.76	3.01	5.14	7.10	9.15
E	1.59	2.59	4.49	6.25	7.98
U	1.49	2.28	3.96	5.55	7.15
F	1.22	2.10	3.57	5.00	6.46
W	1.07	1.88	3.23	4.50	5.87
G	1.01	1.64	2.95	4.12	5.40
X	0.96	1.50	2.74	3.80	4.98
K	0.92	1.41	2.56	3.52	4.64
Y	0.88	1.34	2.39	3.25	4.32
Q	0.86	1.29	2.24	3.04	4.06
Z or "-": Default	0.82	1.24	2.07	2.89	3.82
M	0.77	1.20	1.94	2.72	3.61
N	0.66	1.15	1.84	2.58	3.41
P	0.51	1.09	1.76	2.45	3.24

Table 8. V<sub>dd</sub> = 2.5V Rise/Fall Times for Specific C<sub>LOAD</sub>

Rise/Fall Time Typ (ns)					
Drive Strength \ C <sub>LOAD</sub>	5 pF	15 pF	30 pF	45 pF	60 pF
L	8.68	13.59	18.36	32.70	42.06
A	4.42	7.18	11.93	16.60	21.38
R	2.93	4.78	8.15	11.19	14.59
B	2.21	3.57	6.19	8.55	11.04
S	1.67	2.87	4.94	6.85	8.80
D	1.50	2.33	4.11	5.68	7.33
T	1.06	2.04	3.50	4.84	6.26
E	0.98	1.69	3.03	4.20	5.51
U	0.93	1.48	2.69	3.73	4.92
F	0.90	1.37	2.44	3.34	4.42
W	0.87	1.29	2.21	3.04	4.02
G or "-": Default	0.67	1.20	2.00	2.79	3.69
X	0.44	1.10	1.86	2.56	3.43
K	0.38	0.99	1.76	2.37	3.18
Y	0.36	0.83	1.66	2.20	2.98
Q	0.34	0.71	1.58	2.07	2.80
Z	0.33	0.65	1.51	1.95	2.65
M	0.32	0.62	1.44	1.85	2.50
N	0.31	0.59	1.37	1.77	2.39
P	0.30	0.57	1.29	1.70	2.28

Table 9. V<sub>dd</sub> = 2.8V Rise/Fall Times for Specific C<sub>LOAD</sub>

Rise/Fall Time Typ (ns)					
Drive Strength \ C <sub>LOAD</sub>	5 pF	15 pF	30 pF	45 pF	60 pF
L	7.93	12.69	17.94	30.10	38.89
A	4.06	6.66	11.04	15.31	19.80
R	2.68	4.40	7.53	10.29	13.37
B	2.00	3.25	5.66	7.84	10.11
S	1.59	2.57	4.54	6.27	8.07
D	1.19	2.14	3.76	5.21	6.72
T	1.00	1.79	3.20	4.43	5.77
E	0.94	1.51	2.78	3.84	5.06
U	0.90	1.38	2.48	3.40	4.50
F	0.87	1.29	2.21	3.03	4.05
W	0.62	1.19	1.99	2.76	3.68
G or "-": Default	0.41	1.08	1.84	2.52	3.36
X	0.37	0.96	1.72	2.33	3.15
K	0.35	0.78	1.63	2.15	2.92
Y	0.33	0.67	1.54	2.00	2.75
Q	0.32	0.63	1.46	1.89	2.57
Z	0.31	0.60	1.39	1.80	2.43
M	0.30	0.57	1.31	1.72	2.30
N	0.30	0.56	1.22	1.63	2.22
P	0.29	0.54	1.13	1.55	2.13

Table 10. V<sub>dd</sub> = 3.3V Rise/Fall Times for Specific C<sub>LOAD</sub>

Rise/Fall Time Typ (ns)					
Drive Strength \ C <sub>LOAD</sub>	5 pF	15 pF	30 pF	45 pF	60 pF
L	7.18	11.59	17.24	27.57	35.57
A	3.61	6.02	10.19	13.98	18.10
R	2.31	3.95	6.88	9.42	12.24
B	1.65	2.92	5.12	7.10	9.17
S	1.43	2.26	4.09	5.66	7.34
D	1.01	1.91	3.38	4.69	6.14
T	0.94	1.51	2.86	3.97	5.25
E	0.90	1.36	2.50	3.46	4.58
U	0.86	1.25	2.21	3.03	4.07
F or "-": Default	0.48	1.15	1.95	2.72	3.65
W	0.38	1.04	1.77	2.47	3.31
G	0.36	0.87	1.66	2.23	3.03
X	0.34	0.70	1.56	2.04	2.80
K	0.33	0.63	1.48	1.89	2.61
Y	0.32	0.60	1.40	1.79	2.43
Q	0.32	0.58	1.31	1.69	2.28
Z	0.30	0.56	1.22	1.62	2.17
M	0.30	0.55	1.12	1.54	2.07
N	0.30	0.54	1.02	1.47	1.97
P	0.29	0.52	0.95	1.41	1.90

### Instant Samples with Time Machine and Field Programmable Oscillators

SiTime supports a field programmable version of the SiT3808 low power oscillator for fast prototyping and real time customization of features. The [field programmable devices](#) (FP devices) are available for all four standard SiT3808 package sizes and can be configured to one's exact specification using the [Time Machine II](#), an USB powered MEMS oscillator programmer.

#### Customizable Features of the SiT3808 FP Devices Include

- Any frequency between 1 and 80 MHz
- Three frequency stability options:  $\pm 10$  ppm,  $\pm 25$  ppm,  $\pm 50$  ppm
- Two operating temperatures:  $-20$  to  $70^{\circ}\text{C}$  or  $-40$  to  $85^{\circ}\text{C}$
- Four supply voltage options: 1.8V, 2.5V, 2.8V, and 3.3V
- Eight pull range options:  $\pm 25$  ppm,  $\pm 50$  ppm,  $\pm 100$  ppm,  $\pm 150$  ppm,  $\pm 200$  ppm,  $\pm 400$  ppm,  $\pm 800$  ppm,  $\pm 1600$  ppm

For more information regarding SiTime's field programmable solutions, visit <http://www.sitime.com/time-machine> and <http://www.sitime.com/fp-devices>.

SiT3808 is typically factory-programmed per customer ordering codes for volume delivery.



# SiT3808

## 1 MHz to 80 MHz High Performance MEMS VCXO

### Dimensions and Patterns

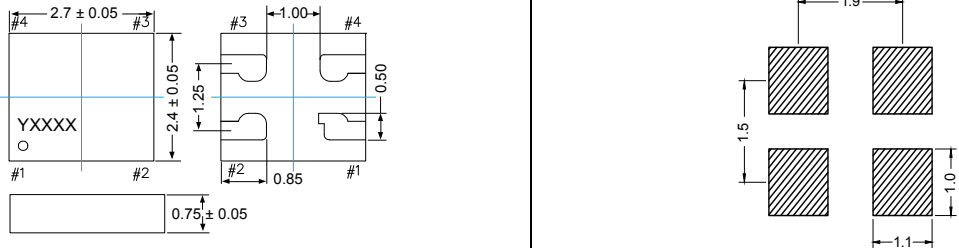
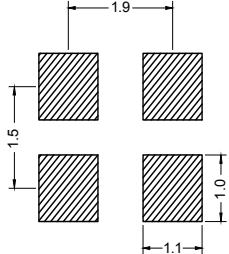
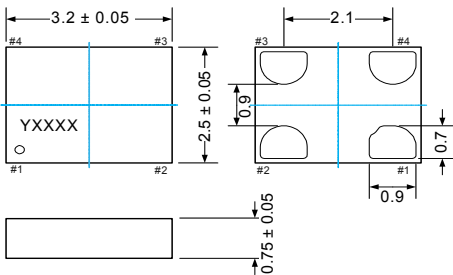
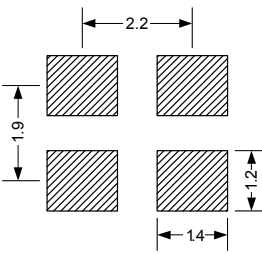
Package Size – Dimensions (Unit: mm) <sup>[15]</sup>	Recommended Land Pattern (Unit: mm)
<p><b>2.7 x 2.4 x 0.75 mm (100% compatible with 2.5 x 2.0 mm footprint)</b></p>  <p>Top view dimensions: 2.7 ± 0.05 mm (width), 2.4 ± 0.05 mm (height). Pin #1 to #4 locations are shown. A 0.75 ± 0.05 mm wide lead is shown.</p> <p>Land pattern dimensions: 1.9 mm (width), 1.5 mm (height), 1.1 mm (width), 1.0 mm (height).</p>	
<p><b>3.2 x 2.5 x 0.75 mm</b></p>  <p>Top view dimensions: 3.2 ± 0.05 mm (width), 2.5 ± 0.05 mm (height). Pin #1 to #4 locations are shown. A 0.75 ± 0.05 mm wide lead is shown.</p> <p>Land pattern dimensions: 2.2 mm (width), 1.9 mm (height), 1.4 mm (width), 1.2 mm (height).</p>	
<p><b>5.0 x 3.2 x 0.75 mm</b></p>  <p>Top view dimensions: 5.0 ± 0.10 mm (width), 3.2 ± 0.10 mm (height). Pin #1 to #6 locations are shown. A 0.75 ± 0.05 mm wide lead is shown.</p> <p>Land pattern dimensions: 2.54 mm (width), 2.20 mm (height), 0.90 mm (width), 1.20 mm (height).</p>	
<p><b>7.0 x 5.0 x 0.90 mm</b></p>  <p>Top view dimensions: 7.0 ± 0.10 mm (width), 5.0 ± 0.10 mm (height). Pin #1 to #6 locations are shown. A 0.90 ± 0.10 mm wide lead is shown.</p> <p>Land pattern dimensions: 5.08 mm (width), 3.80 mm (height), 1.60 mm (width), 1.60 mm (height).</p>	

**Note:**  
 15. Top marking: Y denotes manufacturing origin and XXXX denotes manufacturing lot number. The value of "Y" will depend on the assembly location of the device.

### Ordering Information

SiT3808AC-22-33EH-49.152000D



**Table 12. APR Definition**

Absolute pull range (APR) = Nominal pull range (PR) - frequency stability (F<sub>stab</sub>) - Aging (F<sub>aging</sub>)

Nominal Pull Range	Frequency Stability		
	± 10	± 25	± 50
		<b>APR (PPM)</b>	
± 25	± 10	–	–
± 50	± 35	± 20	–
± 100	± 85	± 70	± 45
± 150	± 135	± 120	± 95
± 200	± 185	± 170	± 145
± 400	± 385	± 370	± 345
± 800	± 785	± 770	± 745
± 1600	± 1585	± 1570	± 1545

**Table 13. Ordering Codes for Supported Tape & Reel Packing Method<sup>[16]</sup>**

Device Size	12 mm T&R (3ku)	12 mm T&R (1ku)	8 mm T&R (3ku)	8 mm T&R (1ku)
2.5 x 2.0 mm	–	–	D	E
3.2 x 2.5 mm	–	–	D	E
5.0 x 3.2 mm	T	Y	–	–
7.0 x 5.0 mm	T	Y	–	–

**Note:**

16. "–" indicates "not available."

**Table 14. Additional Information**

Document	Description	Download Link
<b>Manufacturing Notes</b>	Tape & Reel dimension, reflow profile and other manufacturing related info	<a href="http://www.sitime.com/component/docman/doc_download/85-manufacturing-notes-for-sitime-oscillators">http://www.sitime.com/component/docman/doc_download/85-manufacturing-notes-for-sitime-oscillators</a>
<b>Qualification Reports</b>	RoHS report, reliability reports, composition reports	<a href="http://www.sitime.com/support/quality-and-reliability">http://www.sitime.com/support/quality-and-reliability</a>
<b>Performance Reports</b>	Additional performance data such as phase noise, current consumption and jitter for selected frequencies	<a href="http://www.sitime.com/support/performance-measurement-report">http://www.sitime.com/support/performance-measurement-report</a>
<b>Termination Techniques</b>	Termination design recommendations	<a href="http://www.sitime.com/support/application-notes">http://www.sitime.com/support/application-notes</a>
<b>Layout Techniques</b>	Layout recommendations	<a href="http://www.sitime.com/support/application-notes">http://www.sitime.com/support/application-notes</a>
<b>VCXO Specifications</b>	Definition of key VCXO specifications such as APR and Kv	<a href="http://www.sitime.com/support2/documents/AN10020_VCXO_SpecDefinitions_rev1.pdf">http://www.sitime.com/support2/documents/AN10020_VCXO_SpecDefinitions_rev1.pdf</a>
<b>VCXO in PLL Design</b>	Selection of VCXO parameters and trade-offs in PLL designs	<a href="http://www.sitime.com/support2/documents/AN10021_VCXO_PLL_Design_Guidelines_1v0.pdf">http://www.sitime.com/support2/documents/AN10021_VCXO_PLL_Design_Guidelines_1v0.pdf</a>

## Revision History

**Table 15. Datasheet Version and Change Log**

Version	Release Date	Change Summary
0.6	1/24/2013	Preliminary
1.0	3/7/14	<ul style="list-style-type: none"> <li>• Preliminary removed from title</li> <li>• Updated features and application</li> <li>• Updated electrical specifications table</li> <li>• Updated figure 4,</li> <li>• Added new 6-pin device for figure 5</li> <li>• Updated timing diagrams</li> <li>• Updated programmable drive strength section</li> <li>• Updated ordering information drawing</li> <li>• Updated APR table</li> <li>• Updated ordering codes for tape and reel table</li> <li>• Reformatted additional information table columns</li> </ul>
1.01	1/8/15	<ul style="list-style-type: none"> <li>• Corrected CLK and VDD functionality description in Table 2</li> <li>• Revised VIN functionality description in Table 3</li> </ul>

© SiTime Corporation 2015. The information contained herein is subject to change at any time without notice. SiTime assumes no responsibility or liability for any loss, damage or defect of a Product which is caused in whole or in part by (i) use of any circuitry other than circuitry embodied in a SiTime product, (ii) misuse or abuse including static discharge, neglect or accident, (iii) unauthorized modification or repairs which have been soldered or altered during assembly and are not capable of being tested by SiTime under its normal test conditions, or (iv) improper installation, storage, handling, warehousing or transportation, or (v) being subjected to unusual physical, thermal, or electrical stress.

**Disclaimer:** SiTime makes no warranty of any kind, express or implied, with regard to this material, and specifically disclaims any and all express or implied warranties, either in fact or by operation of law, statutory or otherwise, including the implied warranties of merchantability and fitness for use or a particular purpose, and any implied warranty arising from course of dealing or usage of trade, as well as any common-law duties relating to accuracy or lack of negligence, with respect to this material, any SiTime product and any product documentation. Products sold by SiTime are not suitable or intended to be used in a life support application or component, to operate nuclear facilities, or in other mission critical applications where human life may be involved or at stake. All sales are made conditioned upon compliance with the critical uses policy set forth below.

**CRITICAL USE EXCLUSION POLICY**  
 BUYER AGREES NOT TO USE SITIME'S PRODUCTS FOR ANY APPLICATION OR IN ANY COMPONENTS USED IN LIFE SUPPORT DEVICES OR TO OPERATE NUCLEAR FACILITIES OR FOR USE IN OTHER MISSION-CRITICAL APPLICATIONS OR COMPONENTS WHERE HUMAN LIFE OR PROPERTY MAY BE AT STAKE.

SiTime owns all rights, title and interest to the intellectual property related to SiTime's products, including any software, firmware, copyright, patent, or trademark. The sale of SiTime products does not convey or imply any license under patent or other rights. SiTime retains the copyright and trademark rights in all documents, catalogs and plans supplied pursuant to or ancillary to the sale of products or services by SiTime. Unless otherwise agreed to in writing by SiTime, any reproduction, modification, translation, compilation, or representation of this material shall be strictly prohibited.

# Supplemental Information

The Supplemental Information section is not part of the datasheet and is for informational purposes only.

# Silicon MEMS Outperforms Quartz

## Best Reliability

Silicon is inherently more reliable than quartz. Unlike quartz suppliers, SiTime has in-house MEMS and analog CMOS expertise, which allows SiTime to develop the most reliable products. Figure 1 shows a comparison with quartz technology.

### Why is SiTime Best in Class:

- SiTime's MEMS resonators are vacuum sealed using an advanced EpiSeal™ process, which eliminates foreign particles and improves long term aging and reliability
- World-class MEMS and CMOS design expertise



Figure 1. Reliability Comparison<sup>[1]</sup>

## Best Aging

Unlike quartz, MEMS oscillators have excellent long term aging performance which is why every new SiTime product specifies 10-year aging. A comparison is shown in Figure 2.

### Why is SiTime Best in Class:

- SiTime's MEMS resonators are vacuum sealed using an advanced EpiSeal process, which eliminates foreign particles and improves long term aging and reliability
- Inherently better immunity of electrostatically driven MEMS resonator



Figure 2. Aging Comparison<sup>[2]</sup>

## Best Electro Magnetic Susceptibility (EMS)

SiTime's oscillators in plastic packages are up to 54 times more immune to external electromagnetic fields than quartz oscillators as shown in Figure 3.

### Why is SiTime Best in Class:

- Internal differential architecture for best common mode noise rejection
- Electrostatically driven MEMS resonator is more immune to EMS

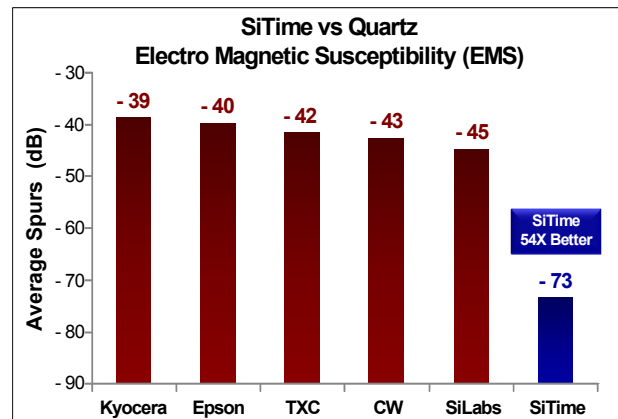

Figure 3. Electro Magnetic Susceptibility (EMS)<sup>[3]</sup>

## Best Power Supply Noise Rejection

SiTime's MEMS oscillators are more resilient against noise on the power supply. A comparison is shown in Figure 4.

### Why is SiTime Best in Class:

- On-chip regulators and internal differential architecture for common mode noise rejection
- Best analog CMOS design expertise



Figure 4. Power Supply Noise Rejection<sup>[4]</sup>

## Best Vibration Robustness

High-vibration environments are all around us. All electronics, from handheld devices to enterprise servers and storage systems are subject to vibration. Figure 5 shows a comparison of vibration robustness.

### Why is SiTime Best in Class:

- The moving mass of SiTime’s MEMS resonators is up to 3000 times smaller than quartz
- Center-anchored MEMS resonator is the most robust design



Figure 5. Vibration Robustness<sup>[5]</sup>

## Best Shock Robustness

SiTime’s oscillators can withstand at least 50,000 g shock. They all maintain their electrical performance in operation during shock events. A comparison with quartz devices is shown in Figure 6.

### Why is SiTime Best in Class:

- The moving mass of SiTime’s MEMS resonators is up to 3000 times smaller than quartz
- Center-anchored MEMS resonator is the most robust design



Figure 6. Shock Robustness<sup>[6]</sup>

### Notes:

1. Data Source: Reliability documents of named companies.
2. Data source: SiTime and quartz oscillator devices datasheets.
3. Test conditions for Electro Magnetic Susceptibility (EMS):
  - According to IEC EN61000-4.3 (Electromagnetic compatibility standard)
  - Field strength: 3V/m
  - Radiated signal modulation: AM 1 kHz at 80% depth
  - Carrier frequency scan: 80 MHz – 1 GHz in 1% steps
  - Antenna polarization: Vertical
  - DUT position: Center aligned to antenna

**Devices used in this test:**  
 SiTime, SiT9120AC-1D2-33E156.250000 - MEMS based - 156.25 MHz  
 Epson, EG-2102CA 156.2500M-PHPAL3 - SAW based - 156.25 MHz  
 TXC, BB-156.250MBE-T - 3rd Overtone quartz based - 156.25 MHz  
 Kyocera, KC7050T156.250P30E00 - SAW based - 156.25 MHz  
 Connor Winfield (CW), P123-156.25M - 3rd overtone quartz based - 156.25 MHz  
 SiLabs, Si590AB-BDG - 3rd overtone quartz based - 156.25 MHz
4. 50 mV pk-pk Sinusoidal voltage.
 

**Devices used in this test:**  
 SiTime, SiT8208AI-33-33E-25.000000, MEMS based - 25 MHz  
 NDK, NZ2523SB-25.6M - quartz based - 25.6 MHz  
 Kyocera, KC2016B25MOC1GE00 - quartz based - 25 MHz  
 Epson, SG-310SCF-25M0-MB3 - quartz based - 25 MHz
5. **Devices used in this test:** same as EMS test stated in Note 3.
6. Test conditions for shock test:
  - MIL-STD-883F Method 2002
  - Condition A: half sine wave shock pulse, 500-g, 1ms
  - Continuous frequency measurement in 100 μs gate time for 10 seconds

**Devices used in this test:** same as EMS test stated in Note 3
7. Additional data, including setup and detailed results, is available upon request to qualified customers. Please contact [productsupport@sitime.com](mailto:productsupport@sitime.com).

# Document Feedback Form



The Smart Timing Choice™

SiTime values your input in improving our documentation. Click [here](#) for our online feedback form or fill out and email the form below to [productsupport@sitime.com](mailto:productsupport@sitime.com).

1. Does the Electrical Characteristics table provide complete information? Yes      No

If No, what parameters are missing?

---

2. Is the organization of this document easy to follow? Yes      No

If "No," please suggest improvements that we can make:

---

3. Is there any application specific information that you would like to see in this document? (Check all that apply)

EMI       Termination recommendations       Shock and vibration performance       Other

If "Other," please specify:

---

4. Are there any errors in this document? Yes      No

If "Yes", please specify (what and where):

---

5. Do you have additional recommendations for this document?

---

Name \_\_\_\_\_

Title \_\_\_\_\_

Company \_\_\_\_\_

Address \_\_\_\_\_

City / State or Province / Postal Code / Country \_\_\_\_\_

Telephone \_\_\_\_\_

Application \_\_\_\_\_

Would you like a reply? Yes      No

Thank you for your feedback. Please click the email icon in your Adobe Reader tool bar and send to [productsupport@sitime.com](mailto:productsupport@sitime.com). Or you may use our [online feedback form](#).



## X-ON Electronics

Largest Supplier of Electrical and Electronic Components

*Click to view similar products for [Standard Clock Oscillators](#) category:*

*Click to view products by [SiTime](#) manufacturer:*

Other Similar products are found below :

[EP1400SJTSC-125.000M](#) [601137](#) [601252](#) [CSX750FBC-24.000M-UT](#) [CSX750FBC-33.333M-UT](#) [CSX750FCC-3.6864M-UT](#) [F335-12](#) [F335-25](#) [F535L-50](#) [DSC506-03FM2](#) [ASA-20.000MHZ-L-T](#) [ASA-25.000MHZ-L-T](#) [ASA-27.000MHZ-L-T](#) [ASV-20.000MHZ-LR-T](#) [ECS-2018-160-BN-TR](#) [EL13C7-H2F-125.00M](#) [MXO45HS-2C-66.6666MHZ](#) [NBXDBB017LN1TAG](#) [NBXHBA019LN1TAG](#) [SiT1602BI-22-33E-50.000000E](#) [SIT8003AC-11-33S-2.04800X](#) [SiT8256AC-23-33E-156.250000X](#) [SIT8918AA-11-33S-50.000000G](#) [SM4420TEV-40.0M-T1K](#) [SMA4306-TL-H](#) [F335-24](#) [F335-40](#) [F335-50](#) [F535L-10](#) [F535L-12](#) [F535L-16](#) [F535L-24](#) [F535L-27](#) [F535L-48](#) [PE7744DW-100.0M](#) [CSX750FBC-20.000M-UT](#) [CSX-750FBC33333000T](#) [CSX750FBC-4.000M-UT](#) [CSX750FBC-7.3728M-UT](#) [CSX750FBC-8.000M-UT](#) [CSX-750FCC14745600T](#) [CSX750FCC-16.000M-UT](#) [CSX-750FCC40000000T](#) [CSX750FCC-4.000M-UT](#) [ASA-22.000MHZ-L-T](#) [ASA2-26.000MHZ-L-T](#) [ASA-40.000MHZ-L-T](#) [ASA-48.000MHZ-L-T](#) [ASA-60.000MHZ-L-T](#) [ASF1-3.686MHZ-N-K-S](#)